



*IN VINO?*



# ULTRAFAST LASER-INDUCED STRUCTURAL CHANGES IN SEMICONDUCTORS

*Eric Mazur*

*Eli Glezer*

*Li Huang*

*Paul Callan*

*Journées "Maxwell"*

*Bordeaux, France*

*20 May 1997*

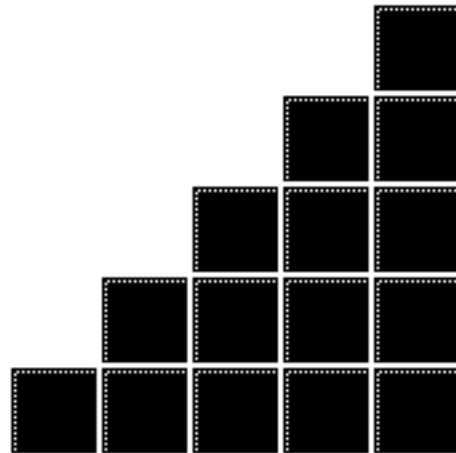

## ***INTRODUCTION***

- 1976: (nanosecond) laser annealing of crystals damaged by ion bombardment
- 1985: femtosecond laser 'melting' of Si

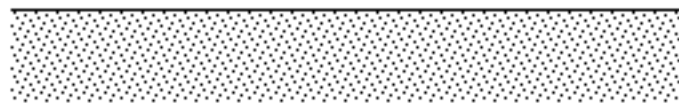

# INTRODUCTION

laser deposits energy near surface...

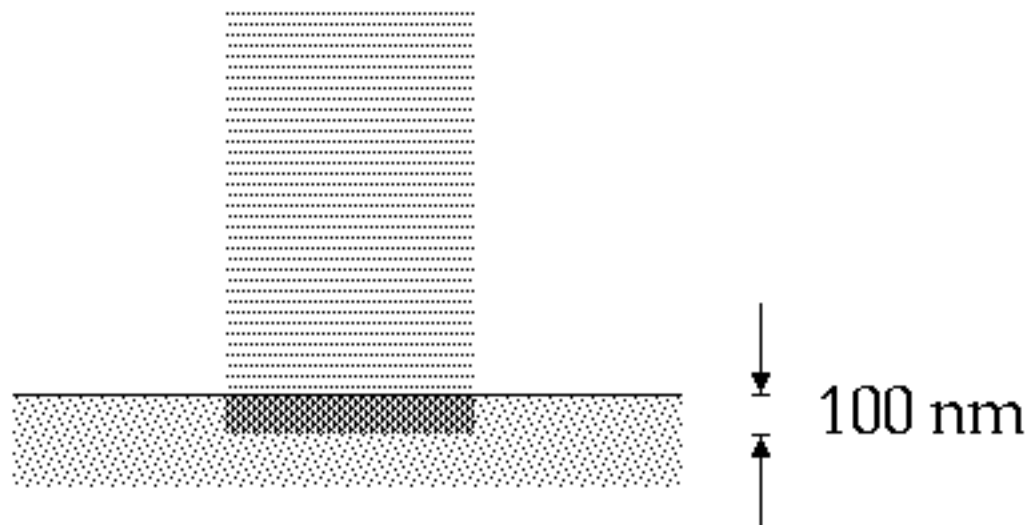

# INTRODUCTION

energy rapidly diffuses into bulk...

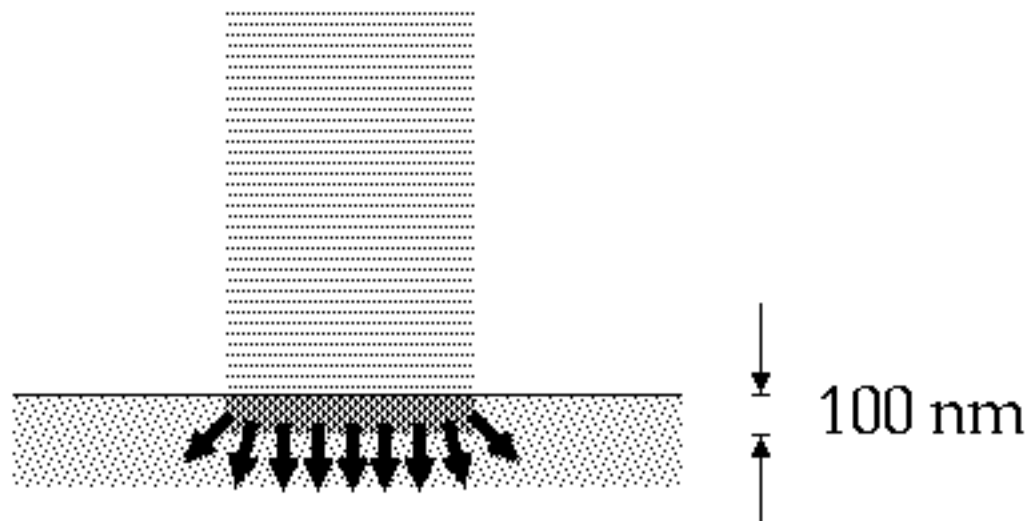

in 1 ns, diffusion length  $\approx 100$  nm



# INTRODUCTION

For  $t < 1$  ns can ignore diffusion

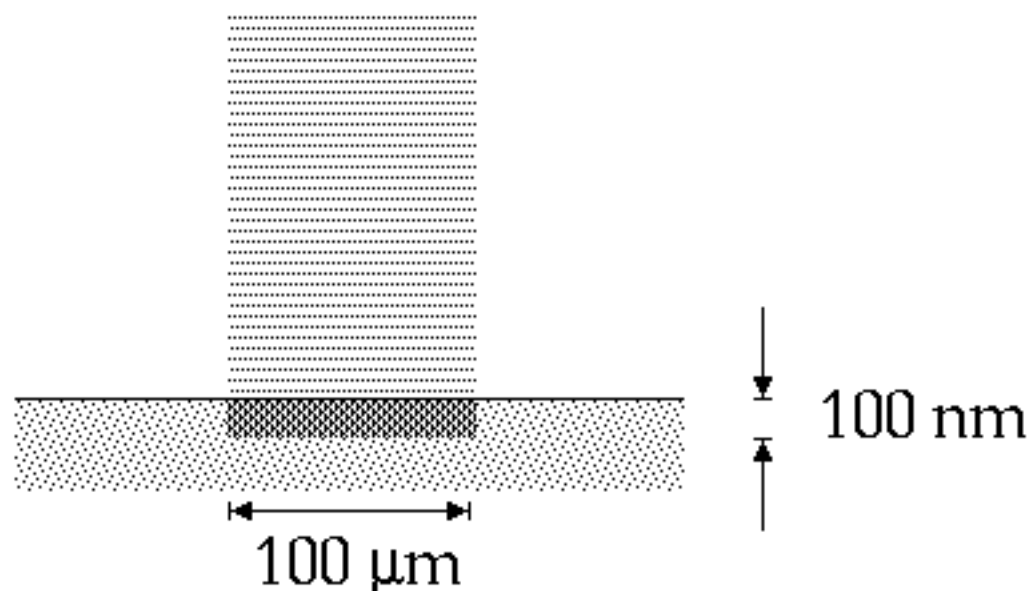

$10\ \mu\text{J}$  into a volume of about  $10^{-15}\ \text{m}^3$ !



- ① Background
- ② Dielectric function
- ③ Nonlinear properties





## *EARLY MODELS*

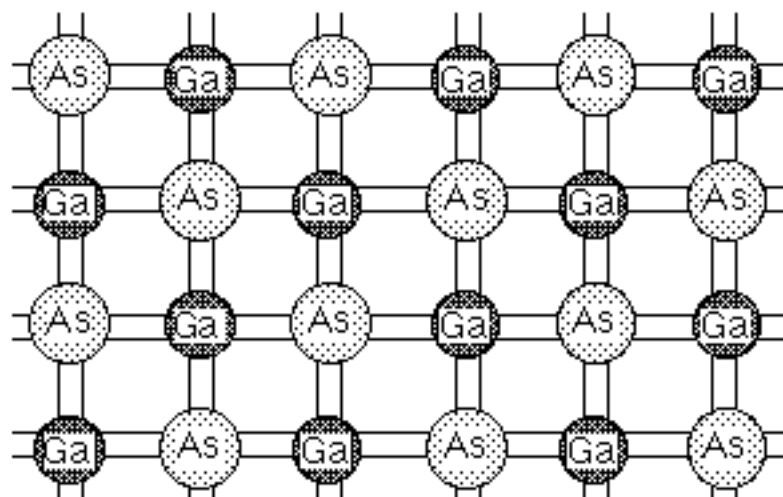

how does light melt a solid?



# ***THERMAL MODEL***

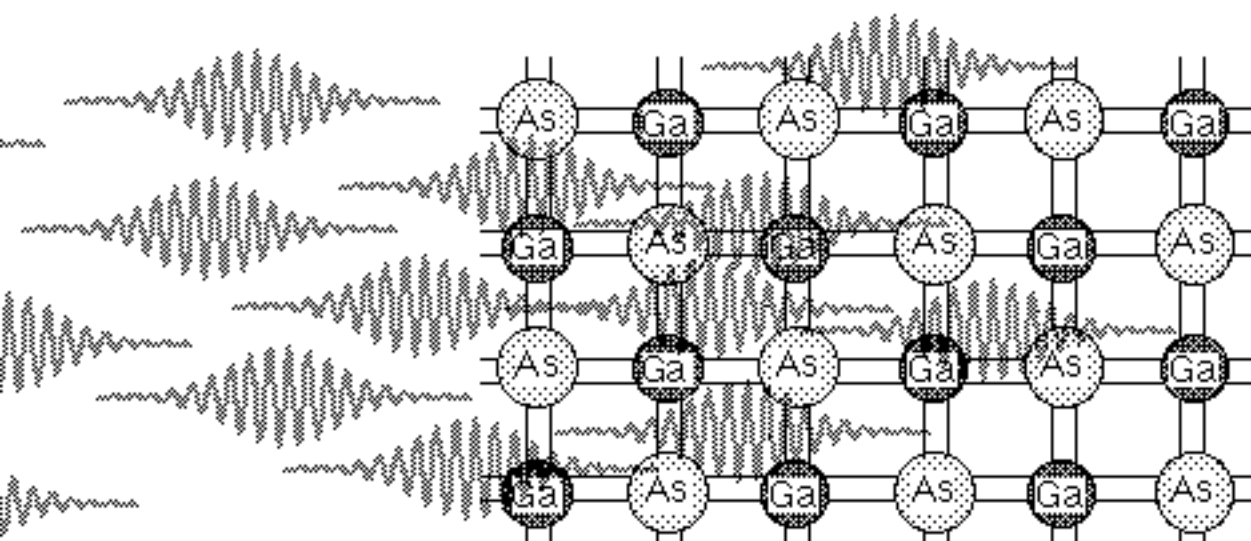

photons excite valence electrons...



# *THERMAL MODEL*

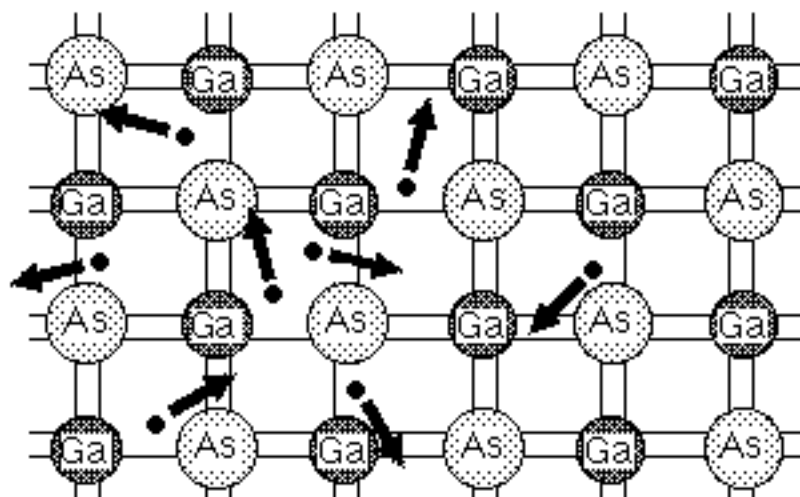

...and create hot electrons...



# *THERMAL MODEL*

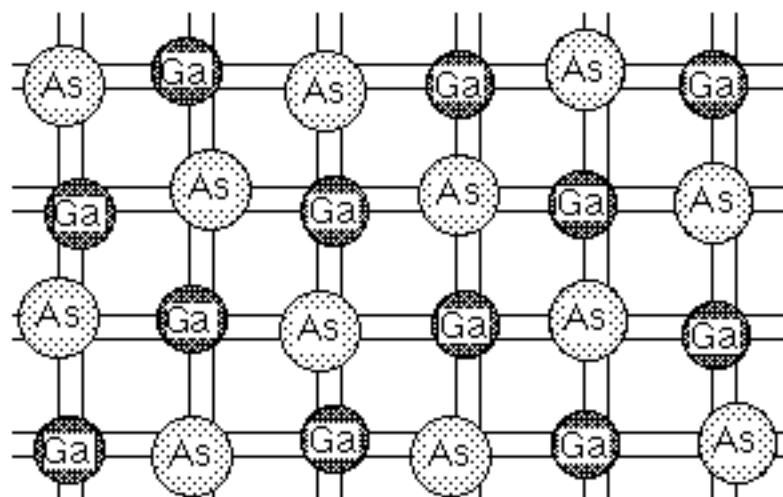

...which heat lattice



# ***THERMAL MODEL***

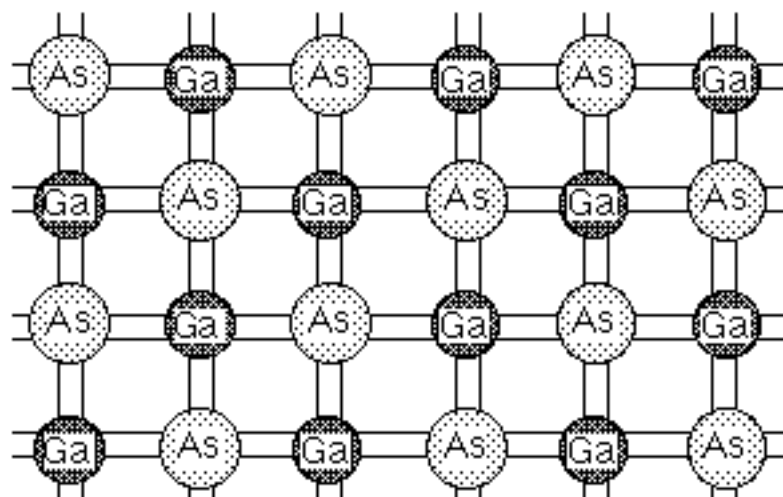

...which heat lattice



# ***THERMAL MODEL***

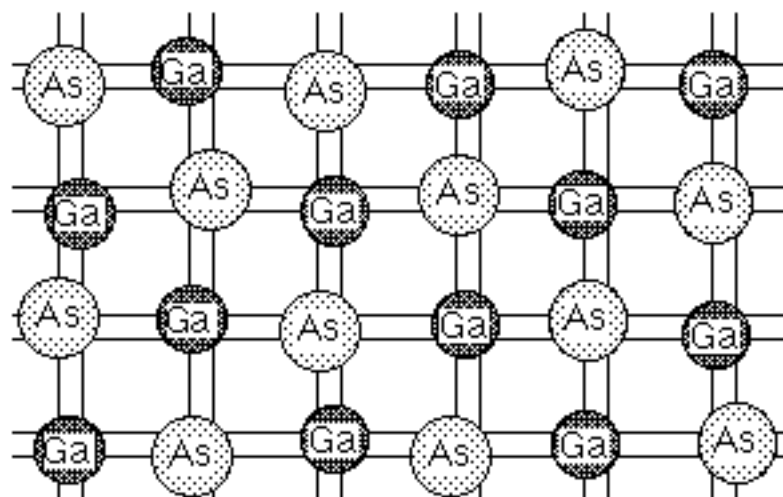

...which heat lattice



# EARLY MODELS

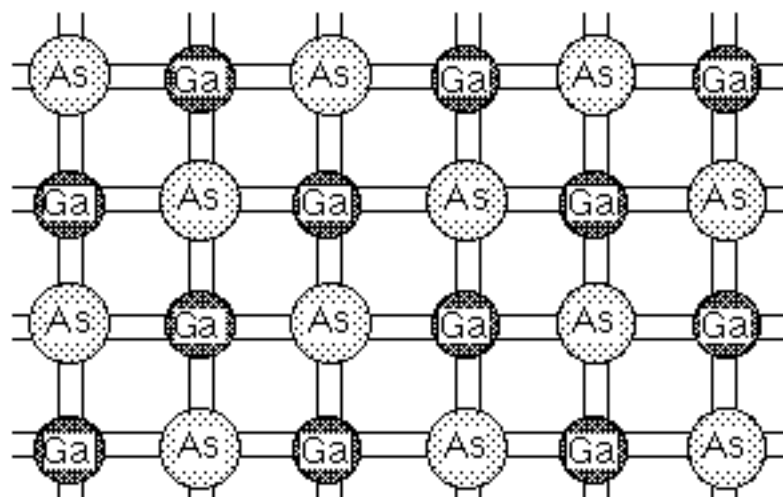

...or...



# *PLASMA ANNEALING*

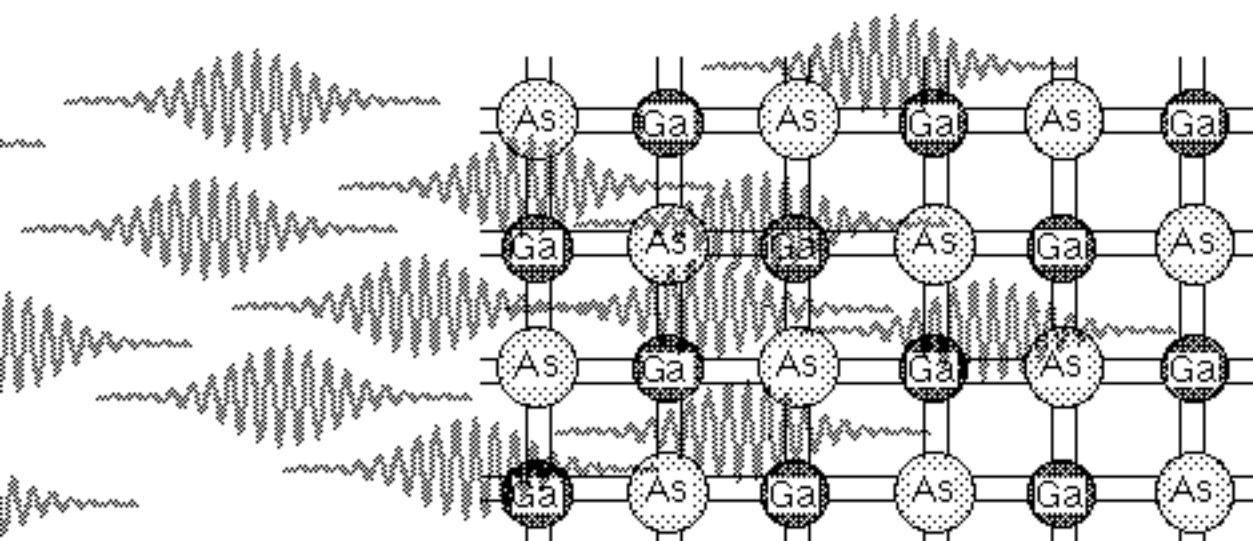

photons excite valence electrons...





# *PLASMA ANNEALING*

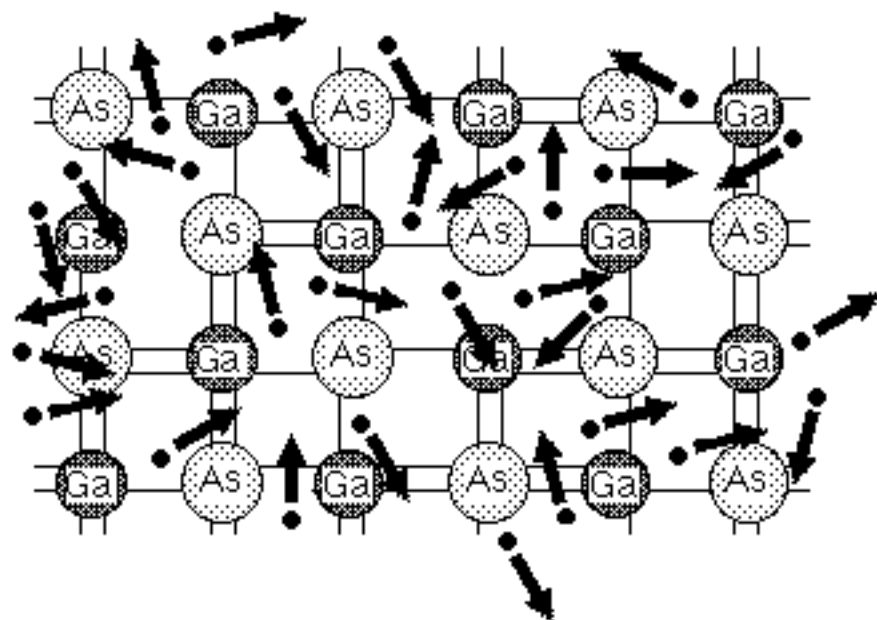

...creating a dense plasma...



# *PLASMA ANNEALING*

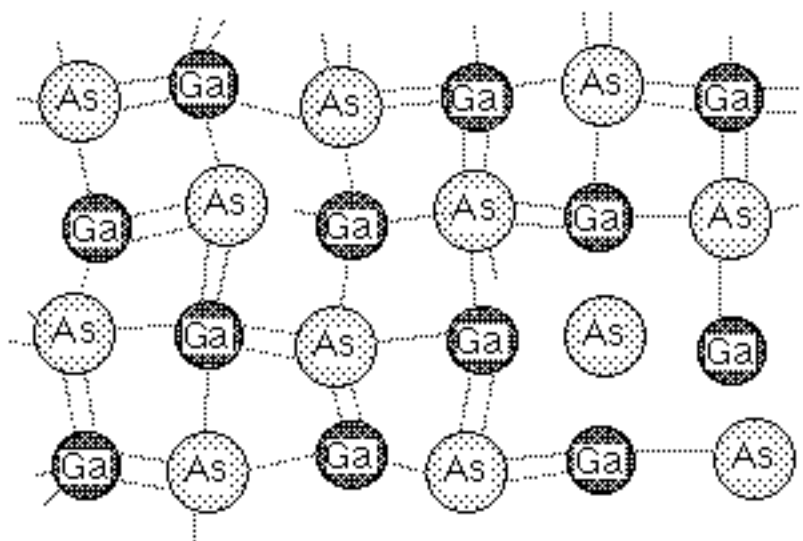

...and breaking bonds



# EXCITATION

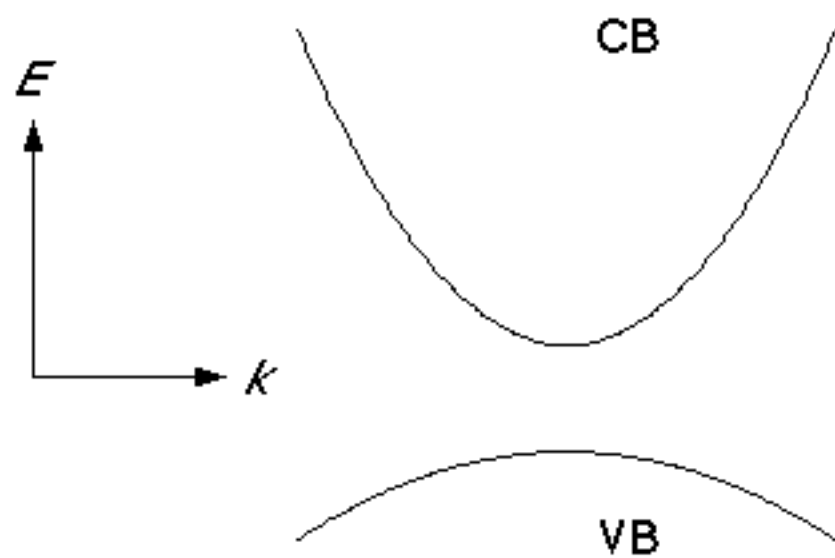

# *EXCITATION*

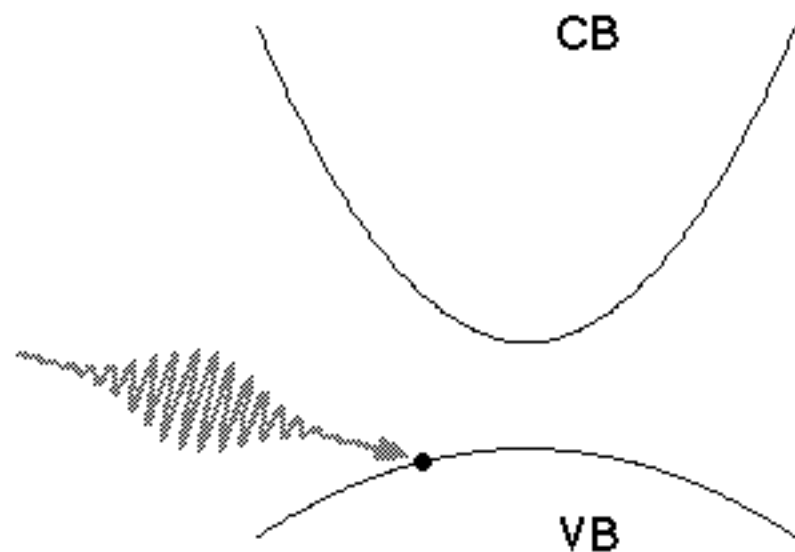

photon excites valence electron



# *EXCITATION*

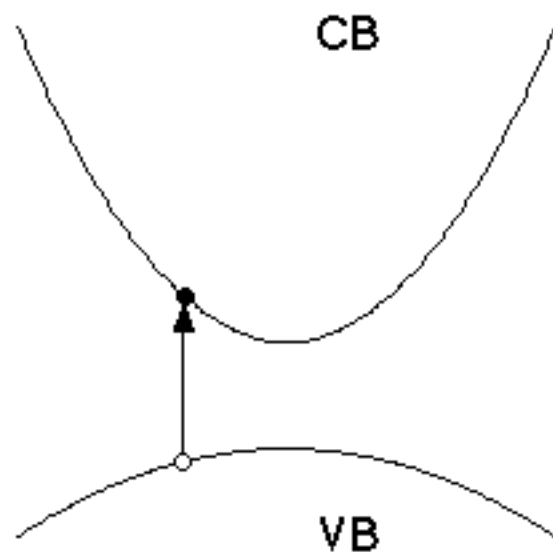

creating an electron-hole pair



# *EXCITATION*

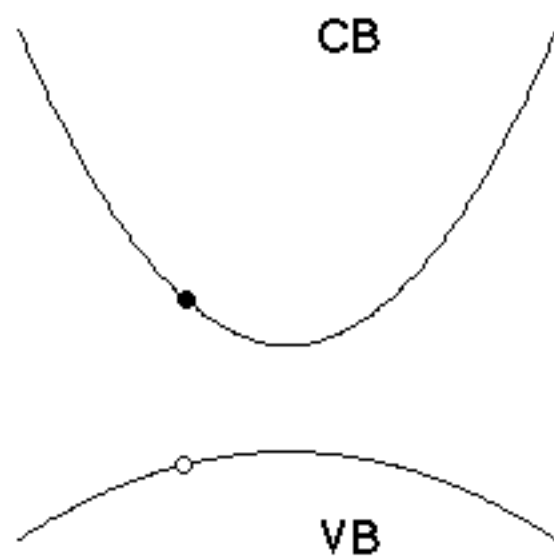

# *EXCITATION*

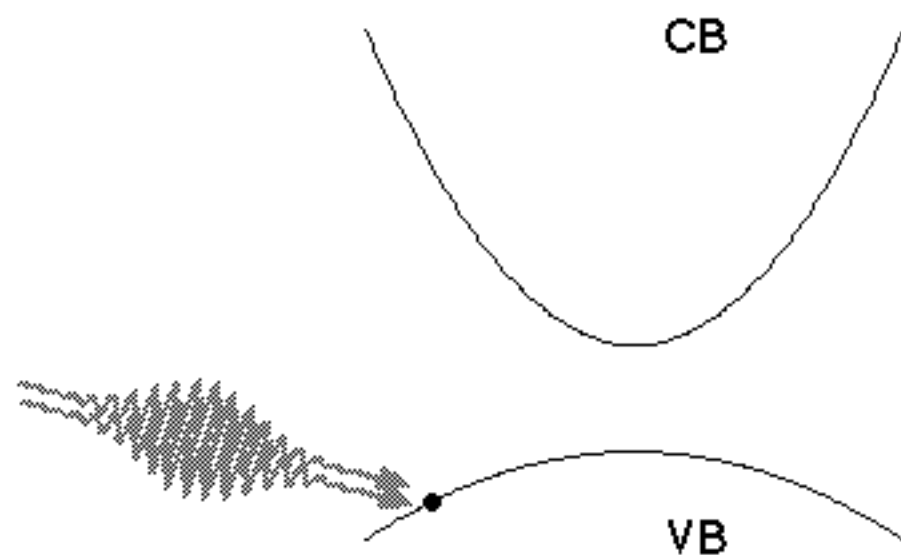

multiphoton excitation



# EXCITATION

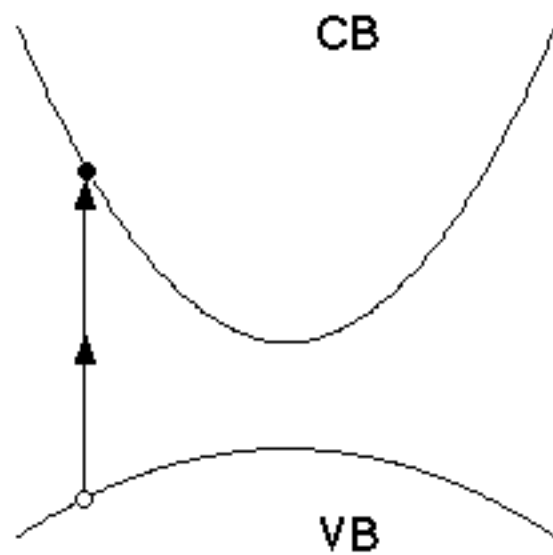



# *EXCITATION*

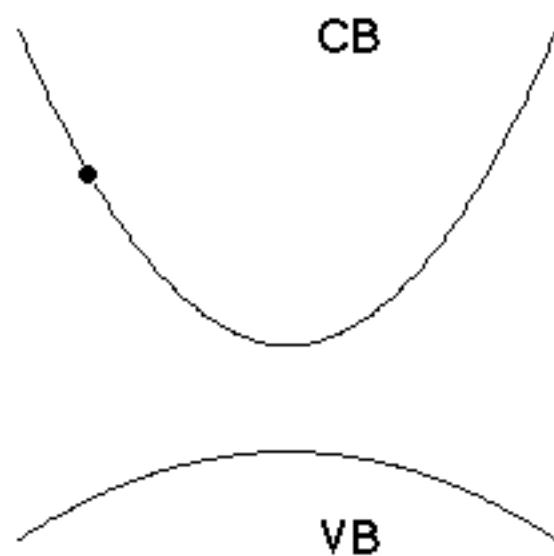

# RELAXATION

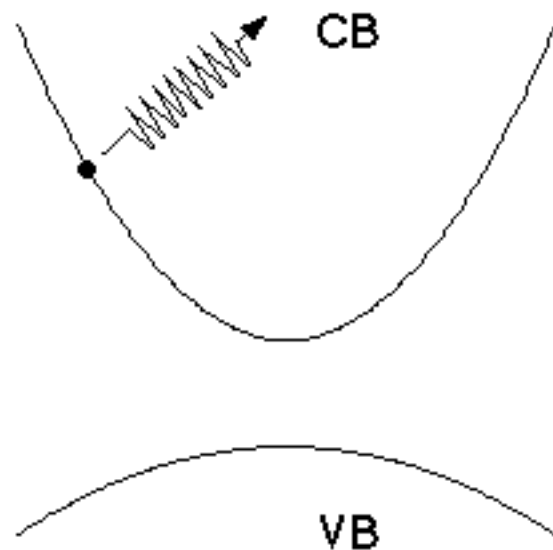

emission of LO phonons



# RELAXATION

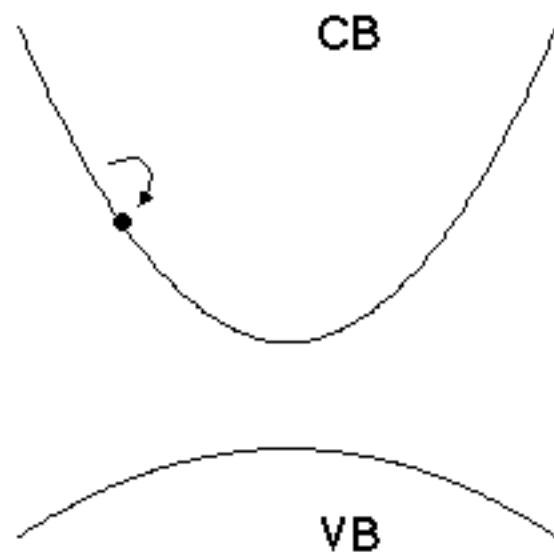

emission of LO phonons



# RELAXATION

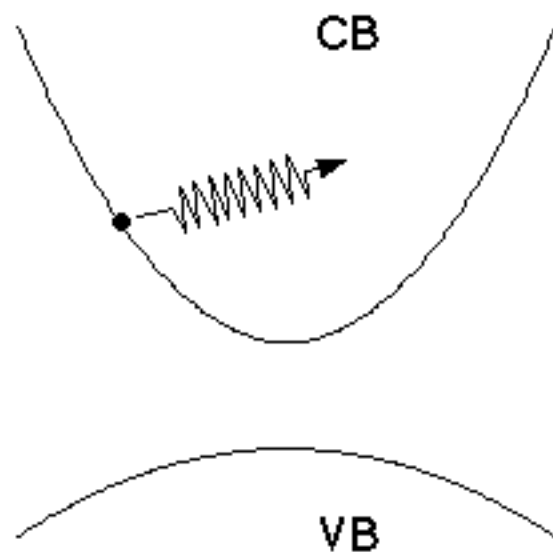

emission of LO phonons



# RELAXATION

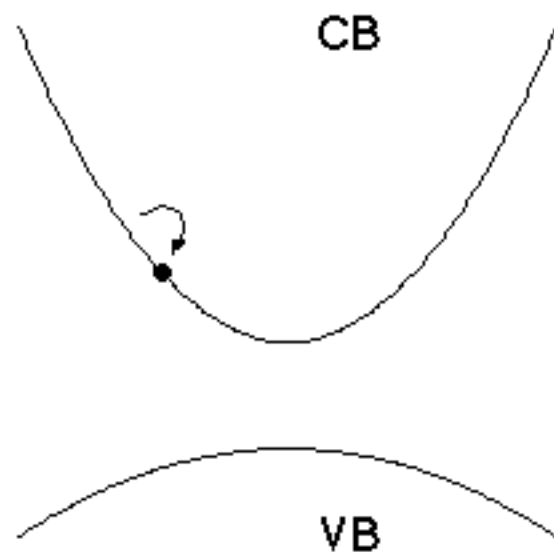

emission of LO phonons



# RELAXATION

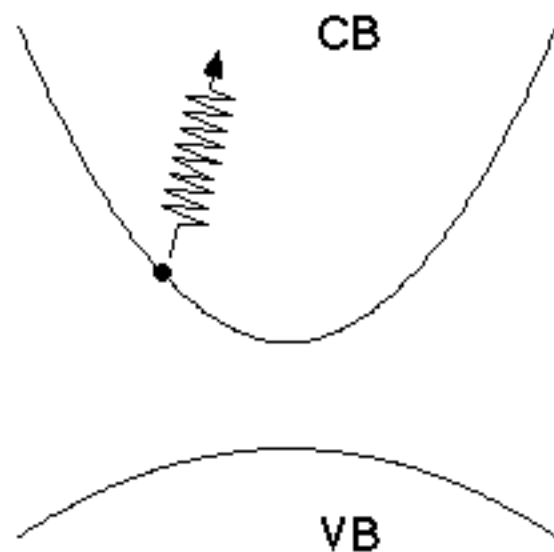

emission of LO phonons



# RELAXATION

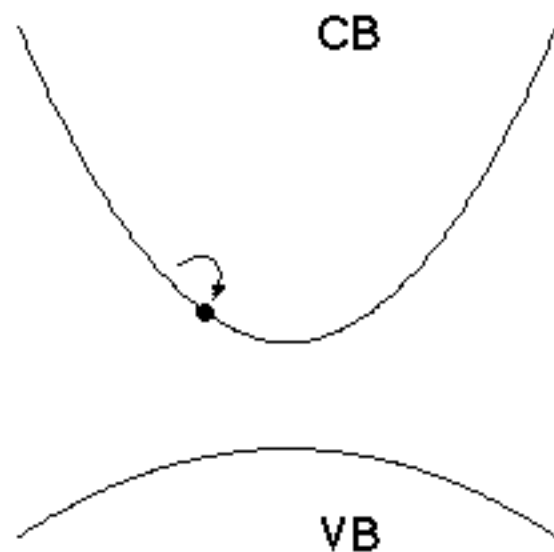

emission of LO phonons



# RELAXATION

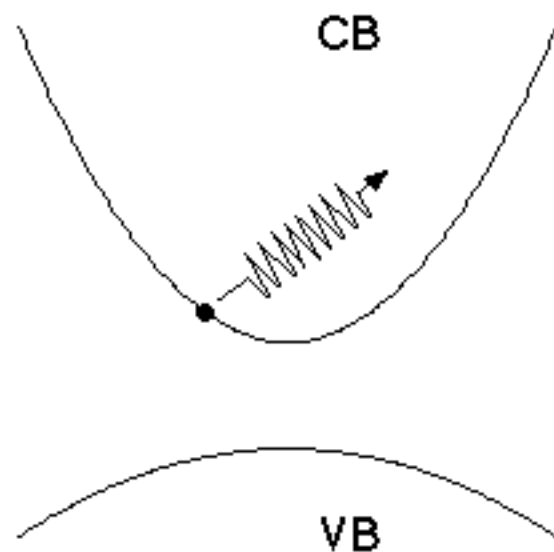

emission of LO phonons





# *RELAXATION*

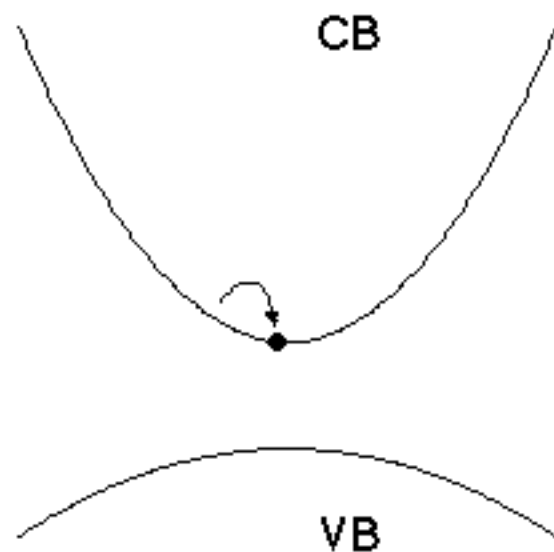

emission of LO phonons



# RELAXATION

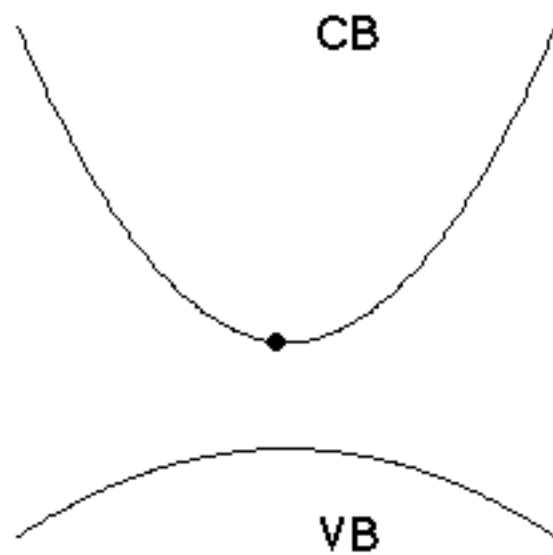

## ***TIME SCALE***

long pulses ( $\tau_{exc} \gg 1$  ps):      *thermal melting*

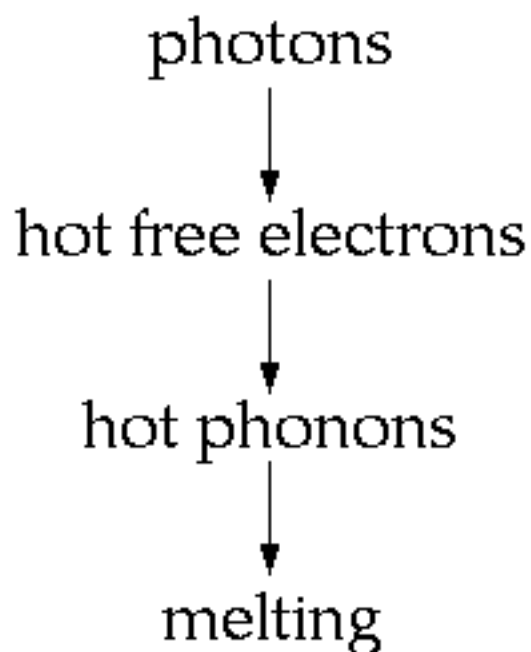

## ***TIME SCALE***

short pulses ( $\tau_{exc} \ll 1$  ps):      *nonthermal disordering*

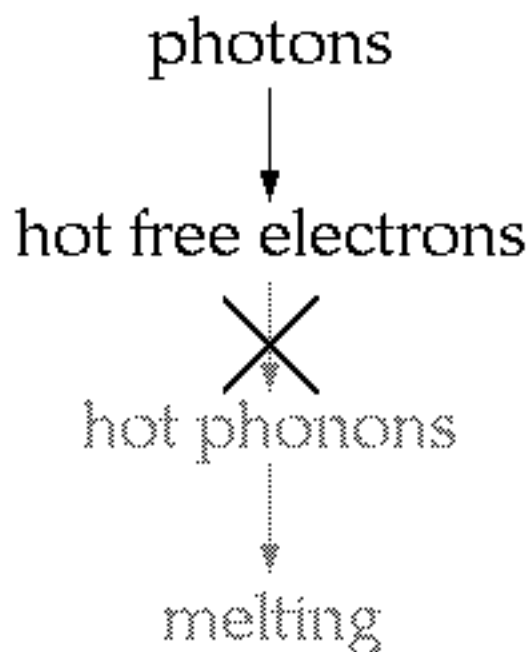

- ① Background
- ② Dielectric function
- ③ Nonlinear properties



# FEMTOSECOND WORK

intense pulses can 'melt' GaAs, Si, but how?

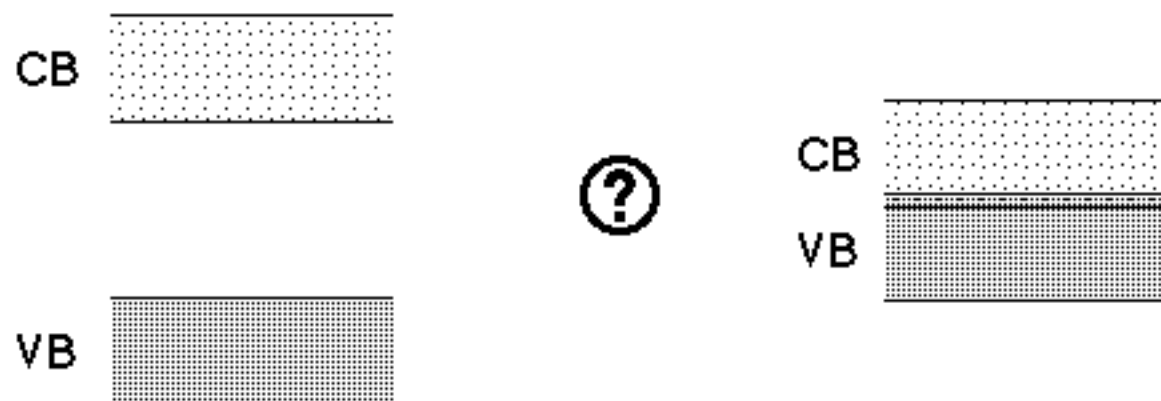

# FEMTOSECOND WORK

intrinsic properties

measured properties

$$\varepsilon', \varepsilon''(\omega) \longrightarrow R$$

$$\begin{array}{l} \varepsilon', \varepsilon''(\omega) \\ \varepsilon', \varepsilon''(2\omega) \\ \chi_{(2)} \end{array} \longrightarrow \text{SHG}$$



## *2.2 eV DIELECTRIC CONSTANT*

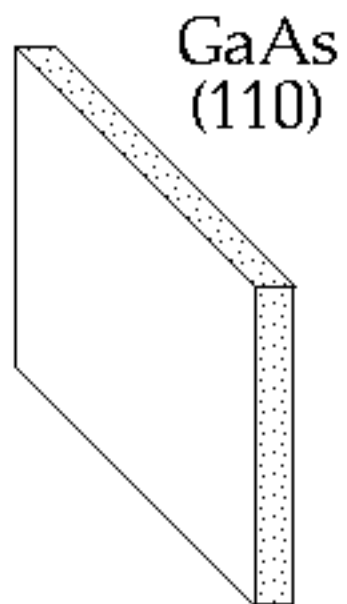



## *2.2 eV DIELECTRIC CONSTANT*

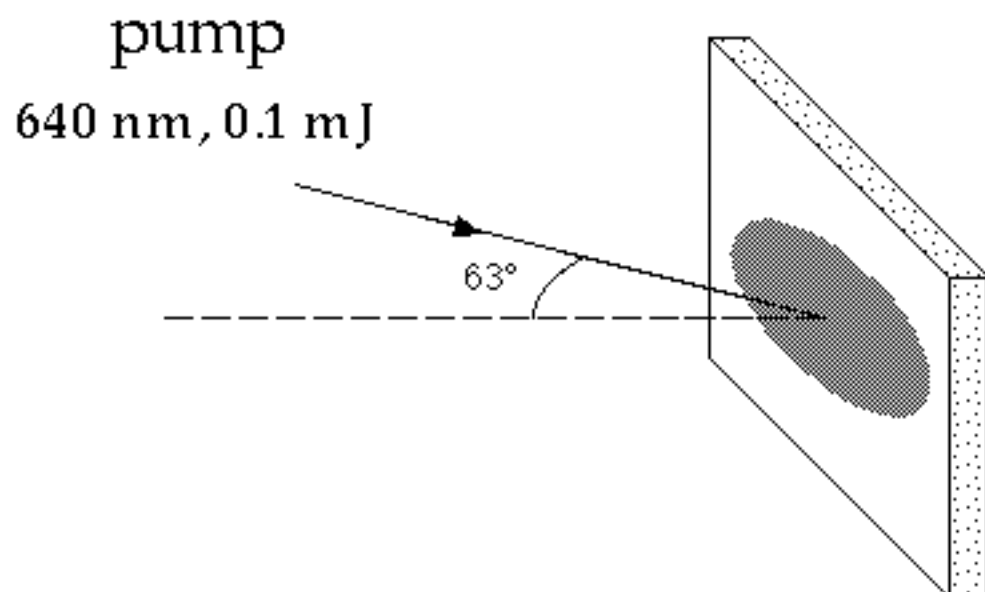

## 2.2 eV DIELECTRIC CONSTANT

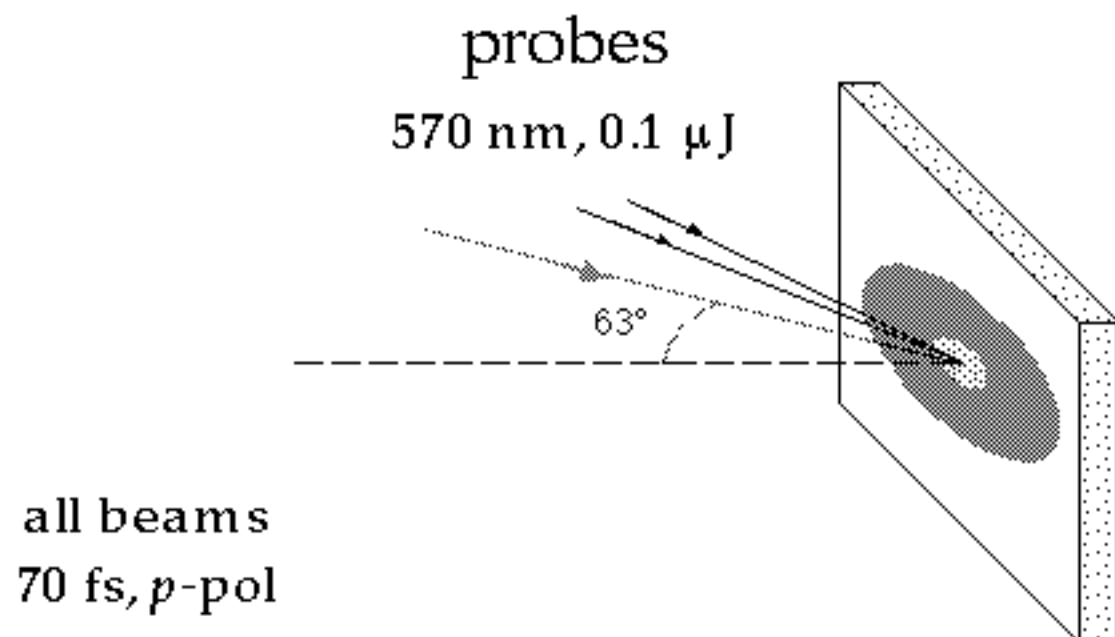

## *2.2 eV DIELECTRIC CONSTANT*

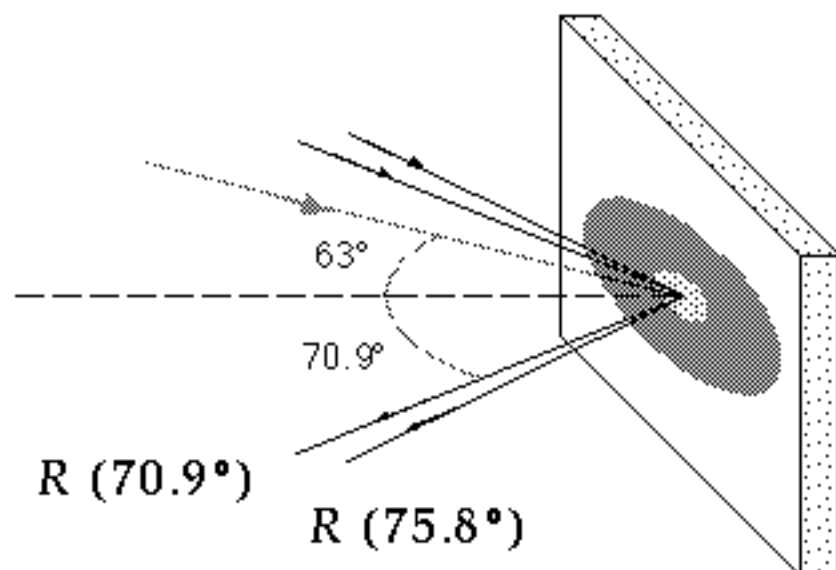

# TIME DEPENDENCE

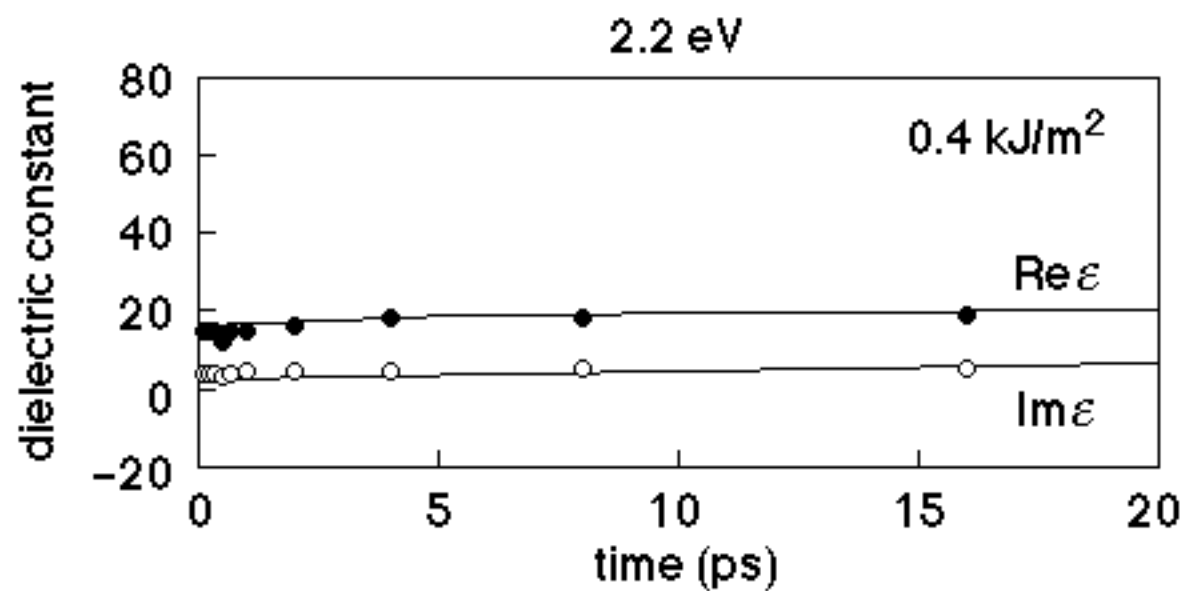

# TIME DEPENDENCE

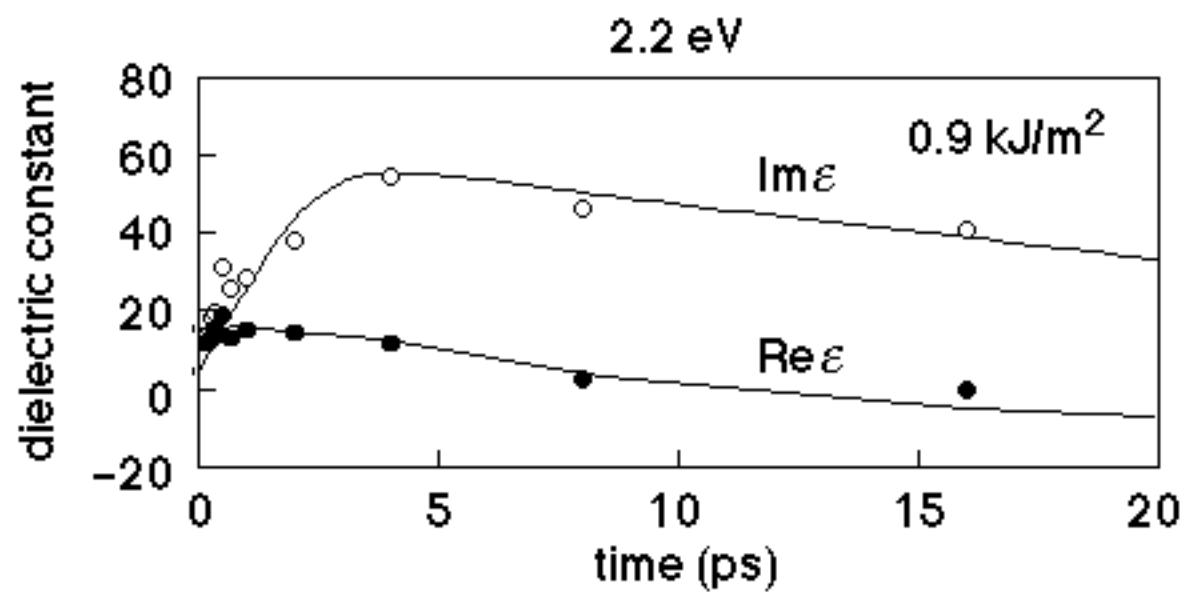

# TIME DEPENDENCE

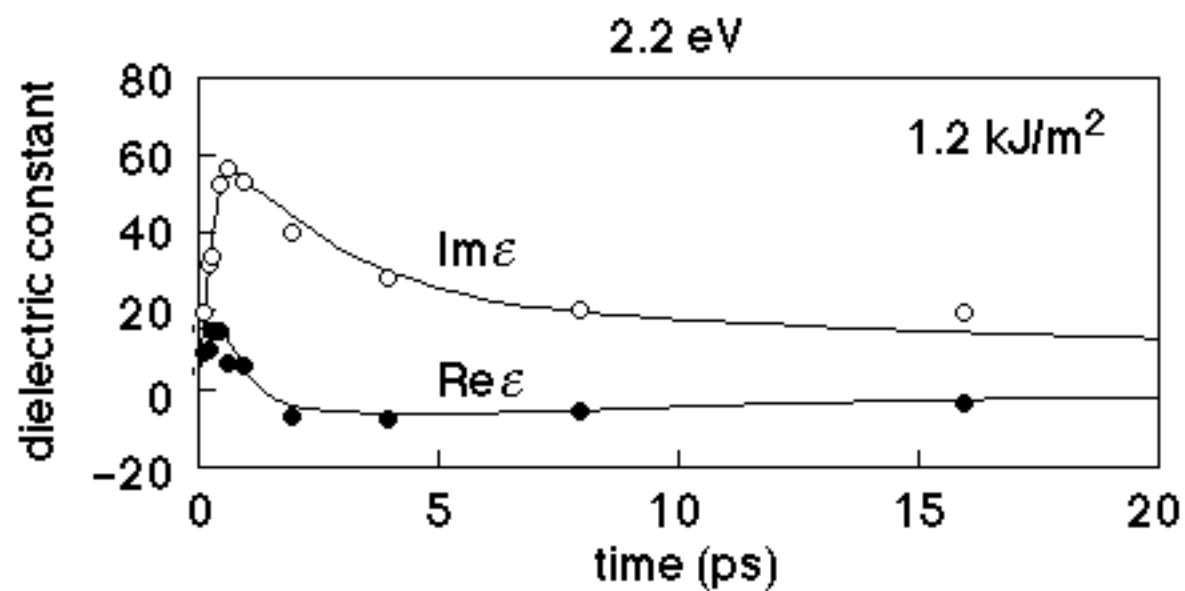

# TIME DEPENDENCE

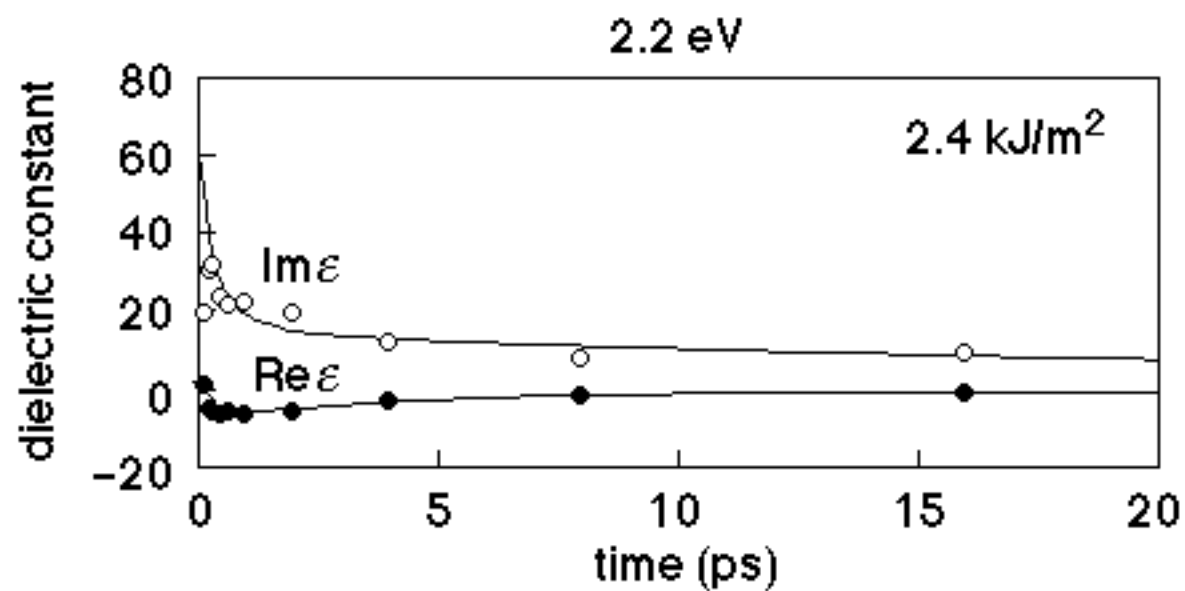

# FLUENCE DEPENDENCE

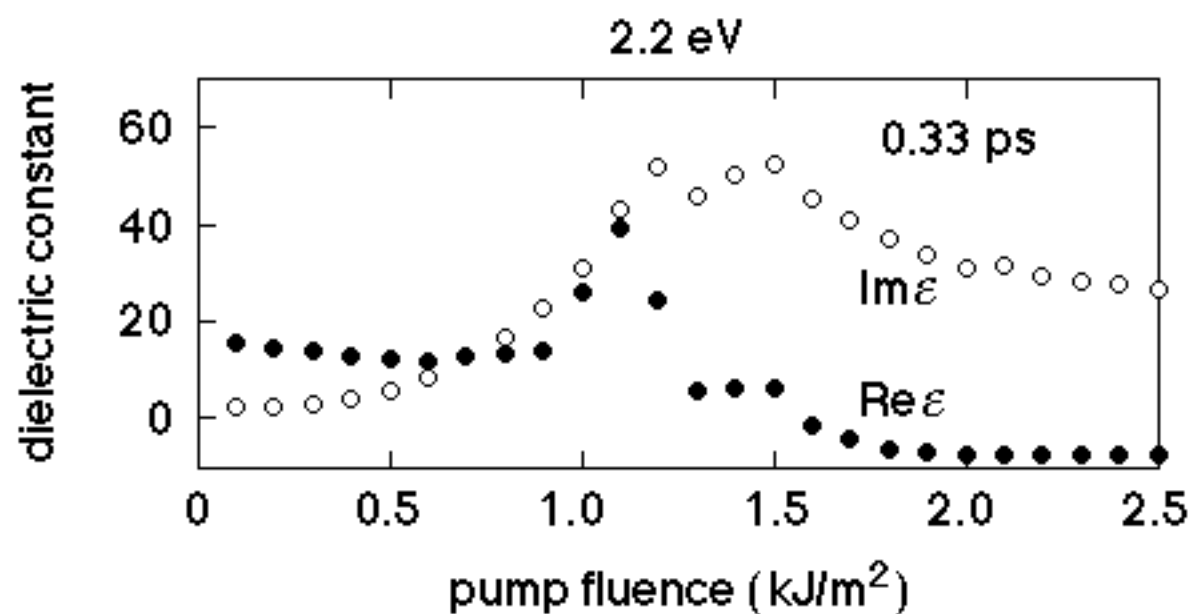



# FLUENCE DEPENDENCE

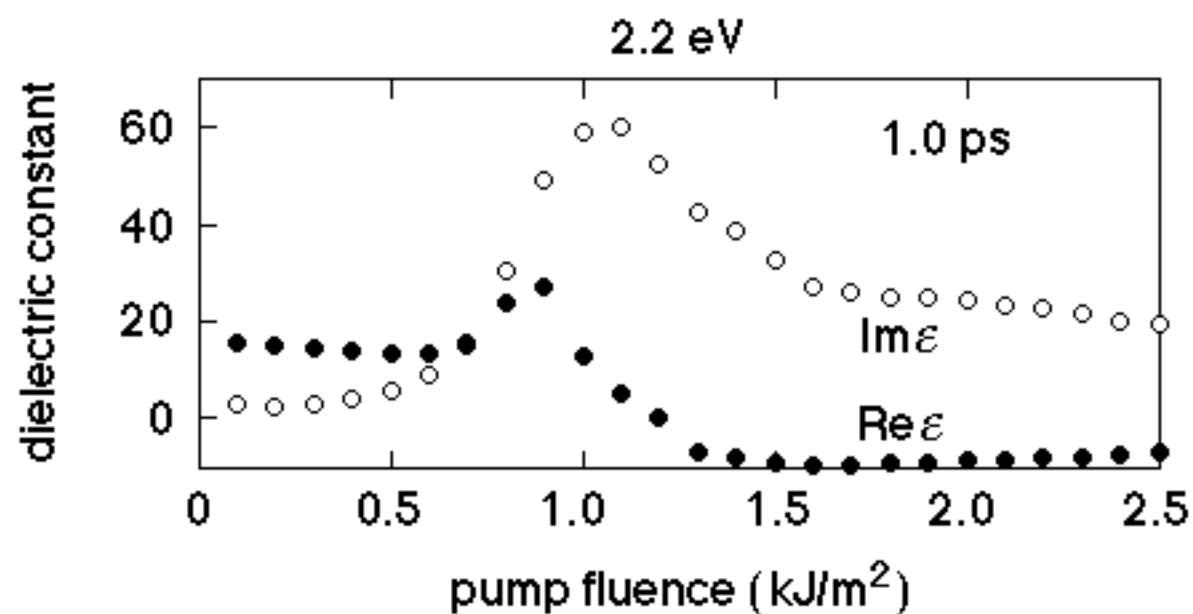

# FLUENCE DEPENDENCE

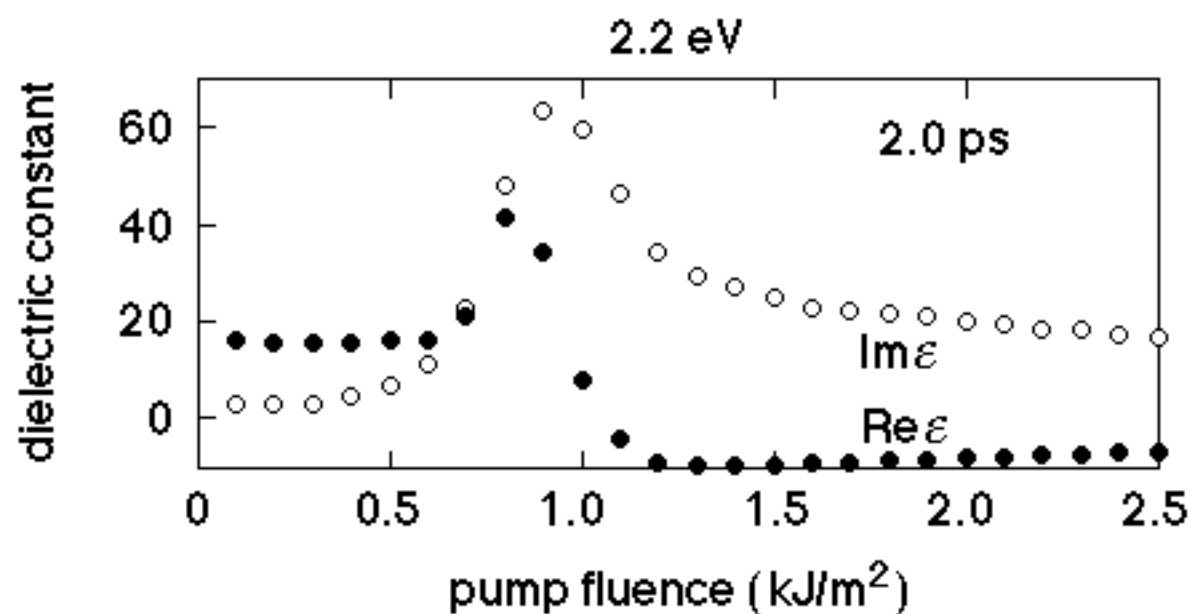

# FLUENCE DEPENDENCE

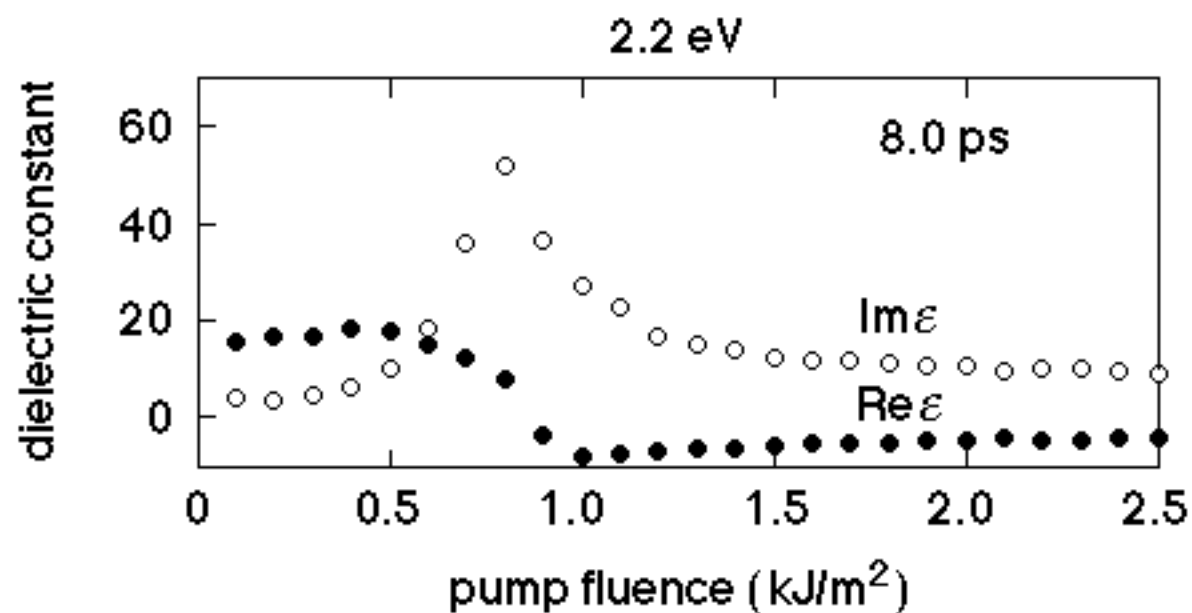

# REVERSIBLE vs. IRREVERSIBLE

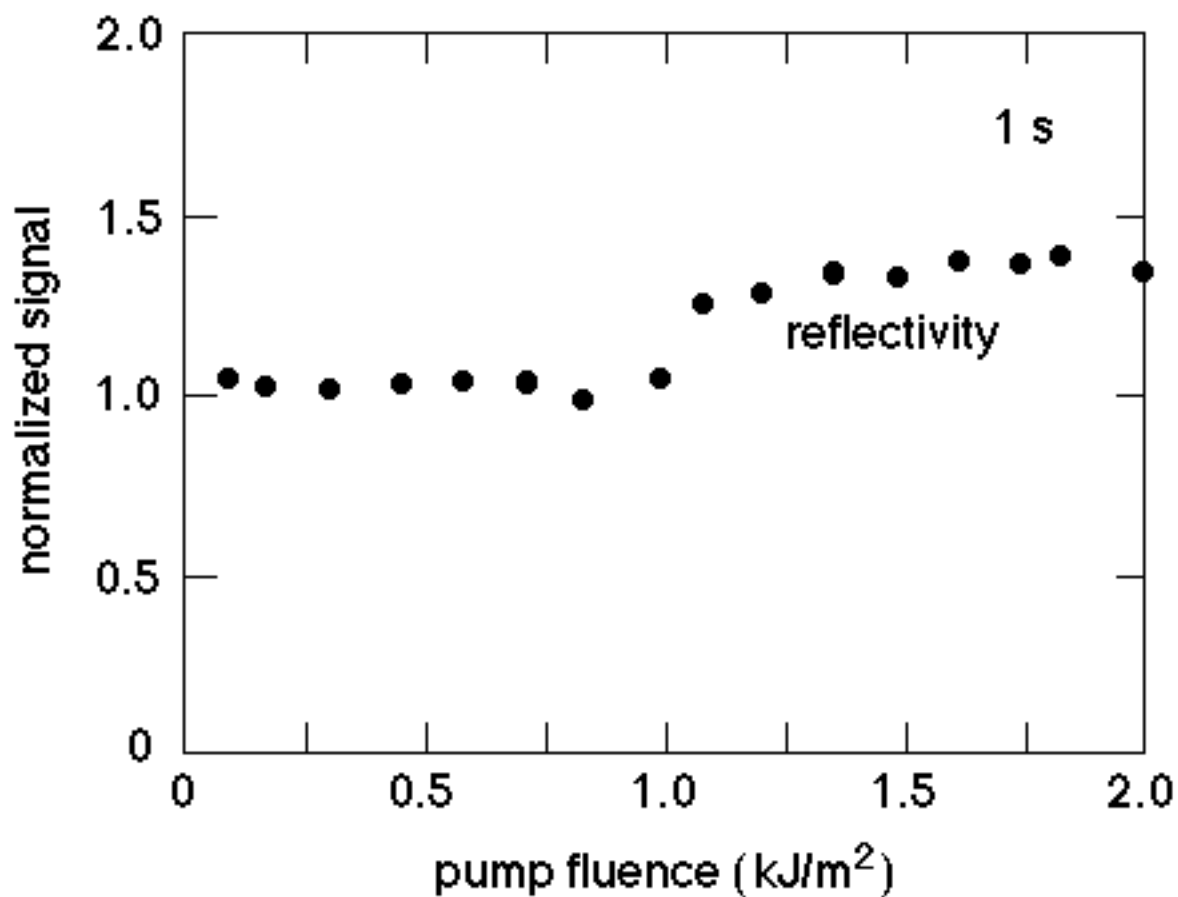

# REVERSIBLE vs. IRREVERSIBLE

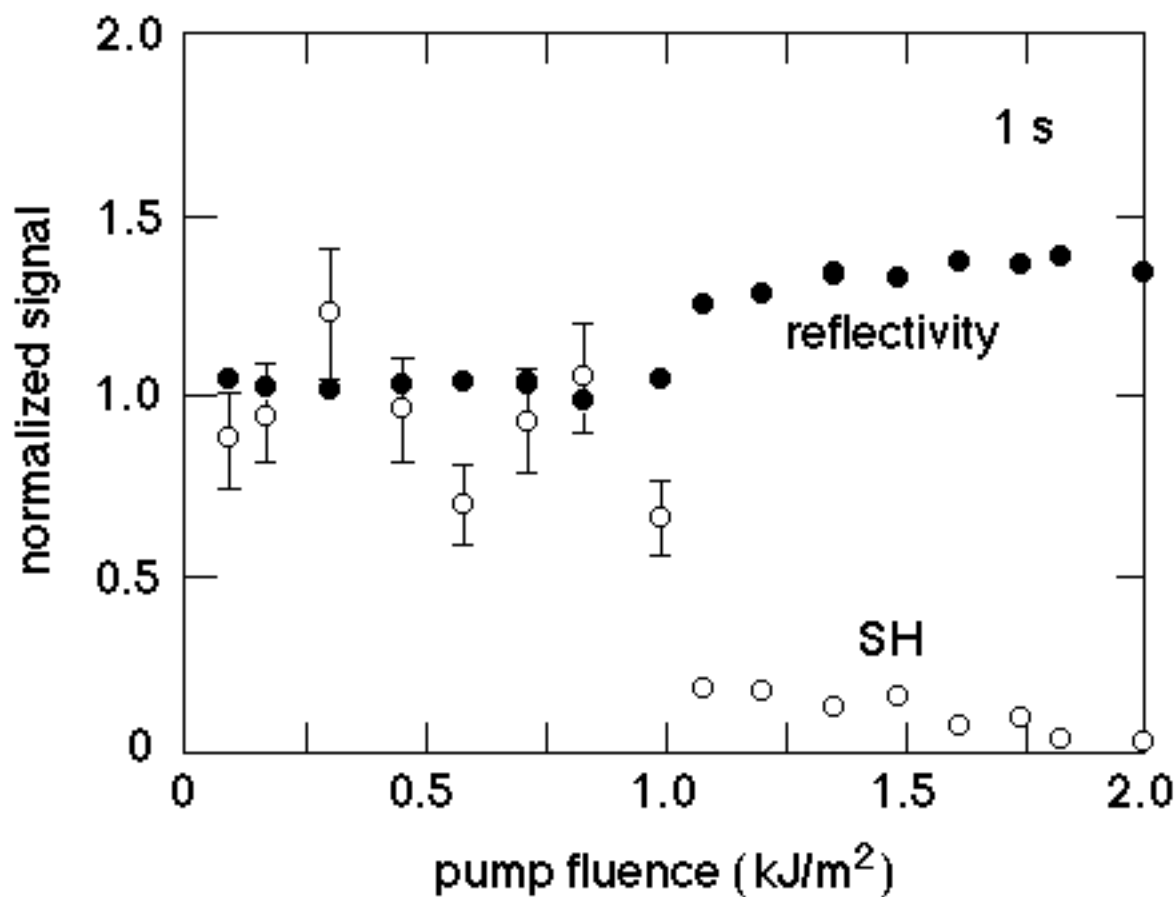

## SIMPLE MODEL

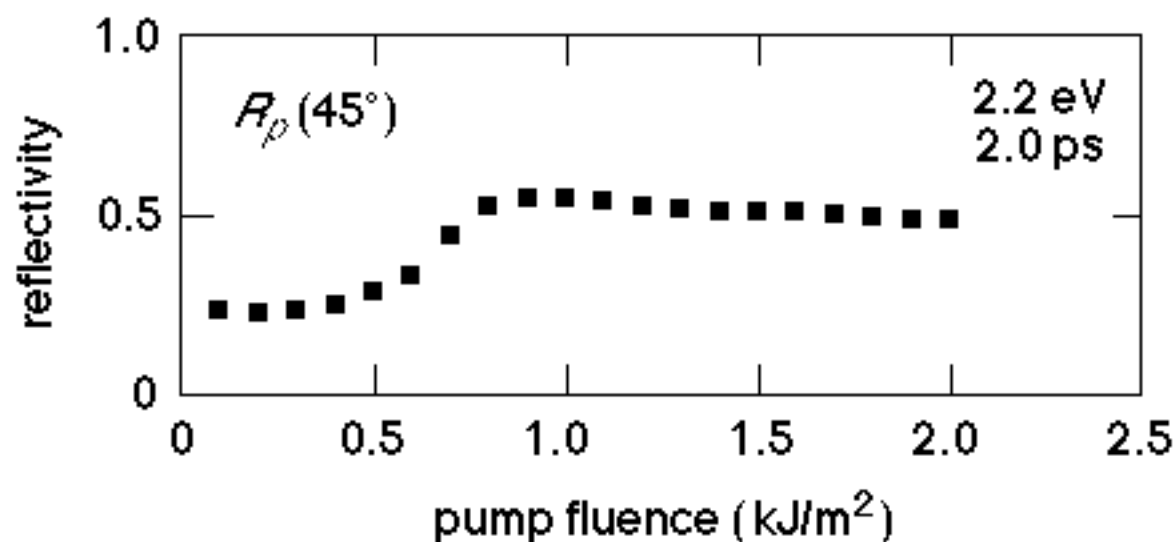

Drude model:

$$\text{Re}(\epsilon) = 1 - \frac{Ne^2}{m\epsilon_0} \frac{1}{\omega^2 + \gamma^2}$$

$$\text{Im}(\epsilon) = \frac{Ne^2}{m\epsilon_0} \frac{\gamma\omega}{\omega^4 + \gamma^2\omega^2}$$



# ***SIMPLE MODEL***

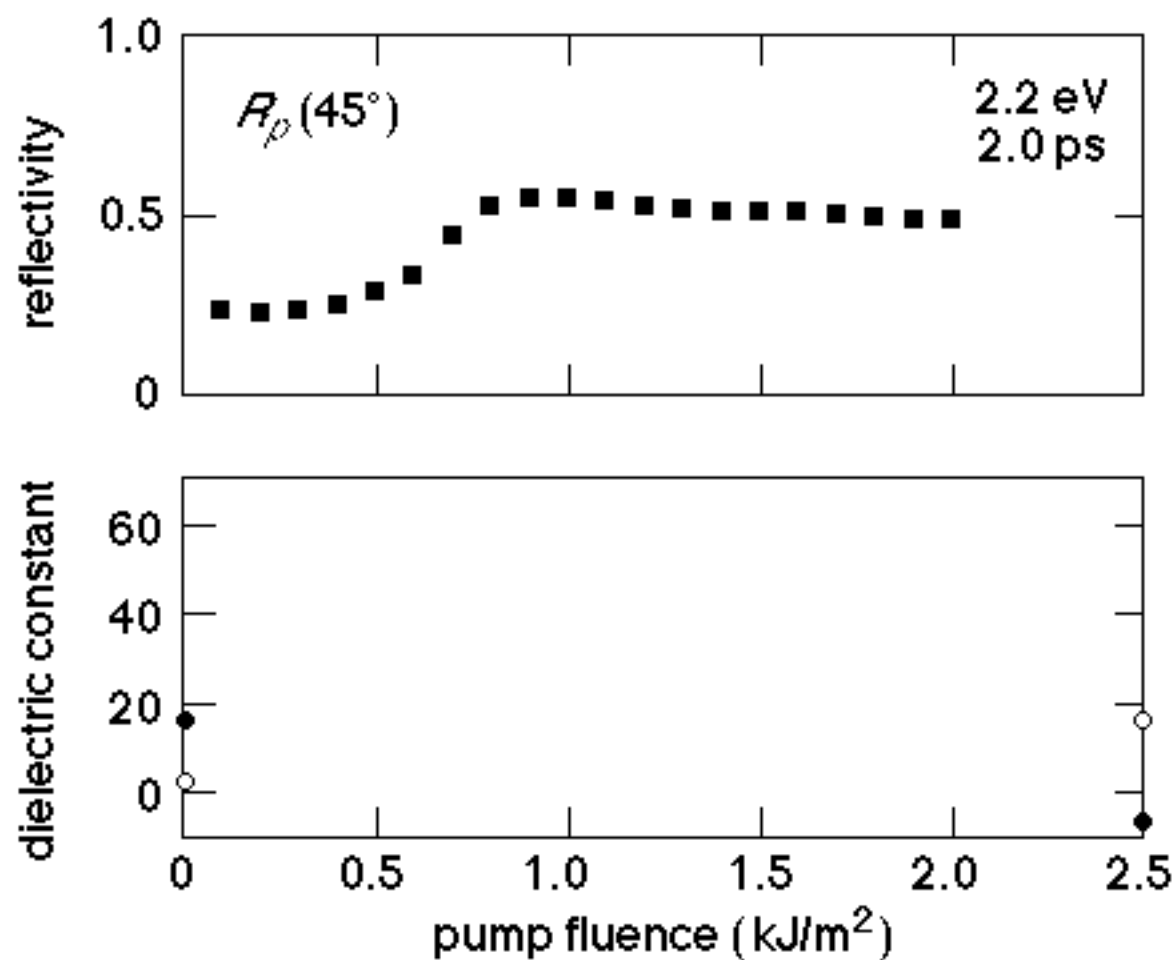

# SIMPLE MODEL

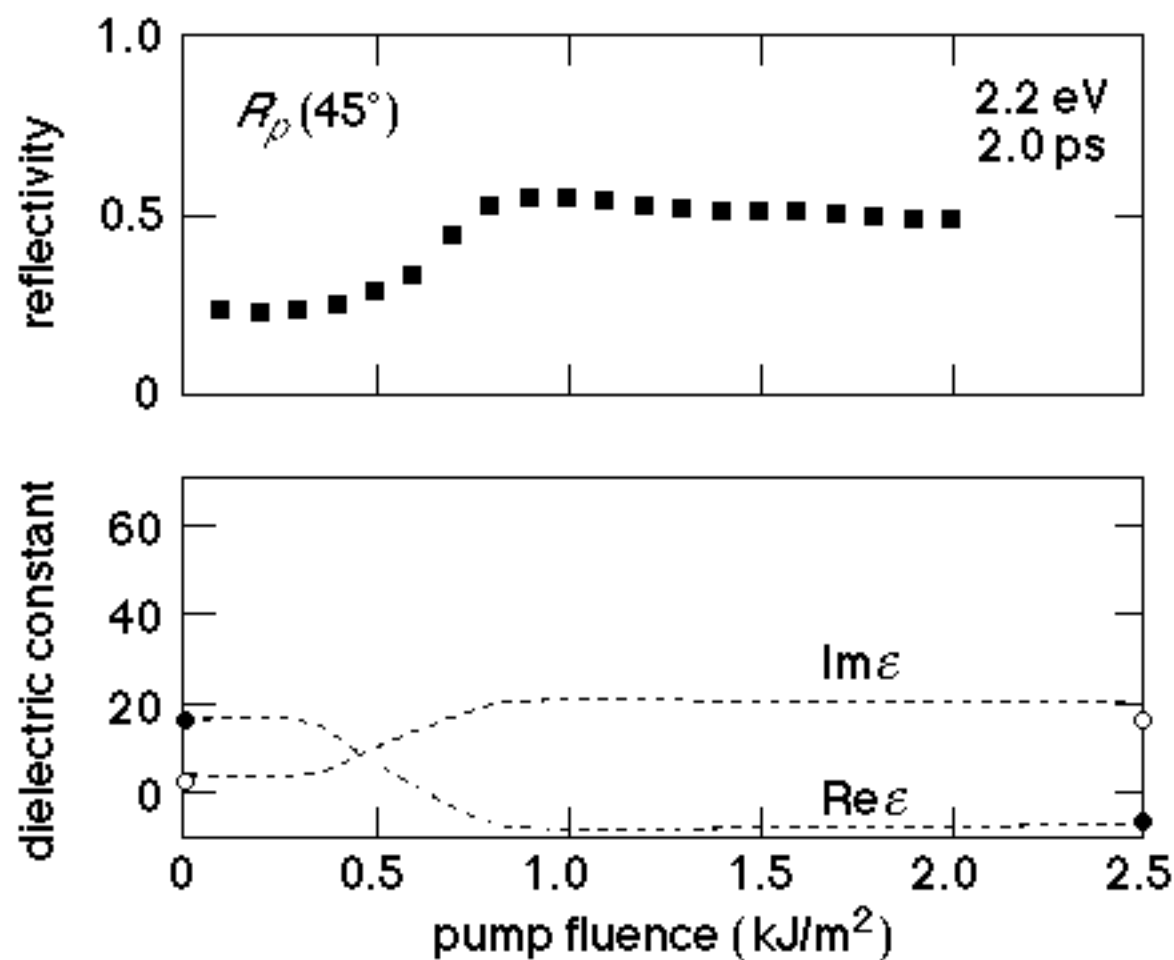



# SIMPLE MODEL

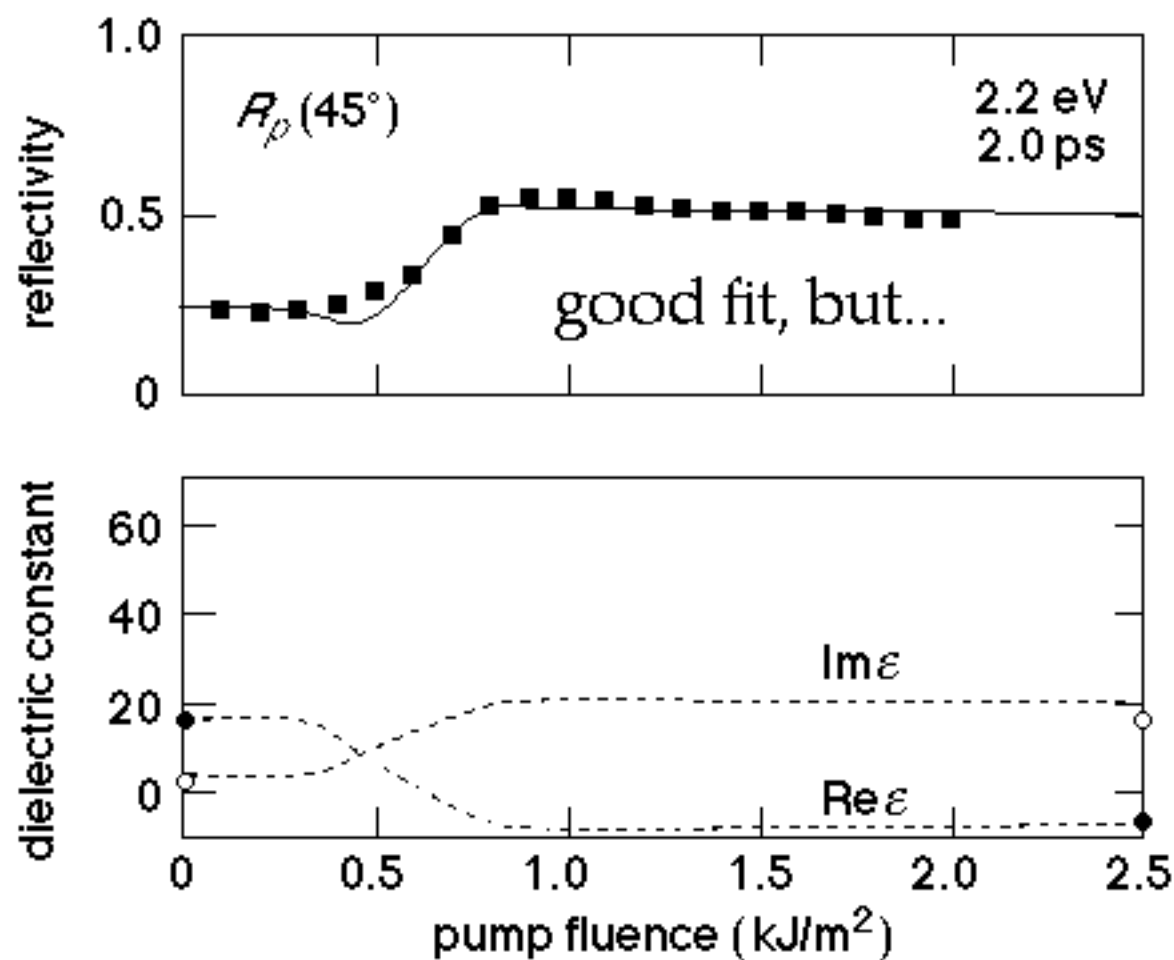

# ***SIMPLE MODEL***

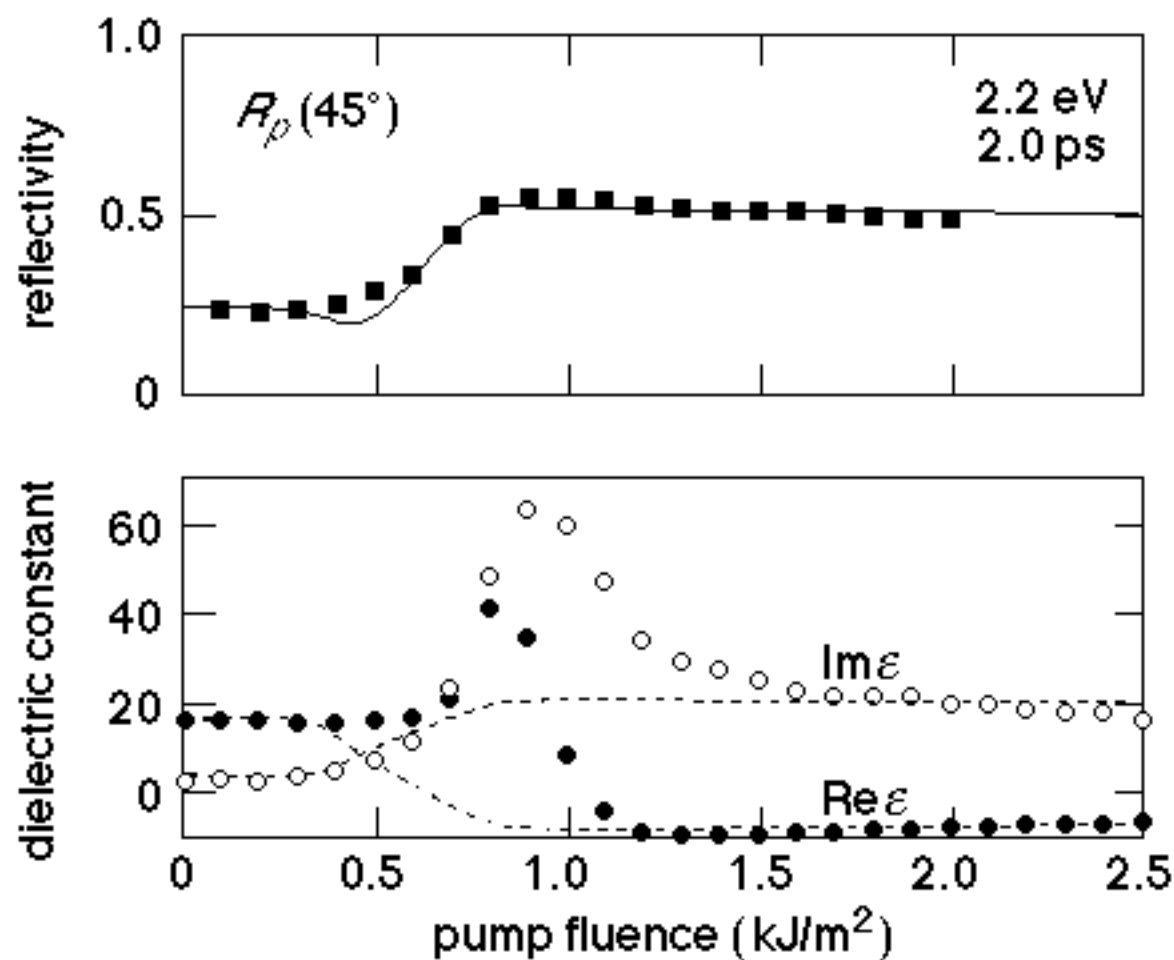

# SIMPLE MODEL

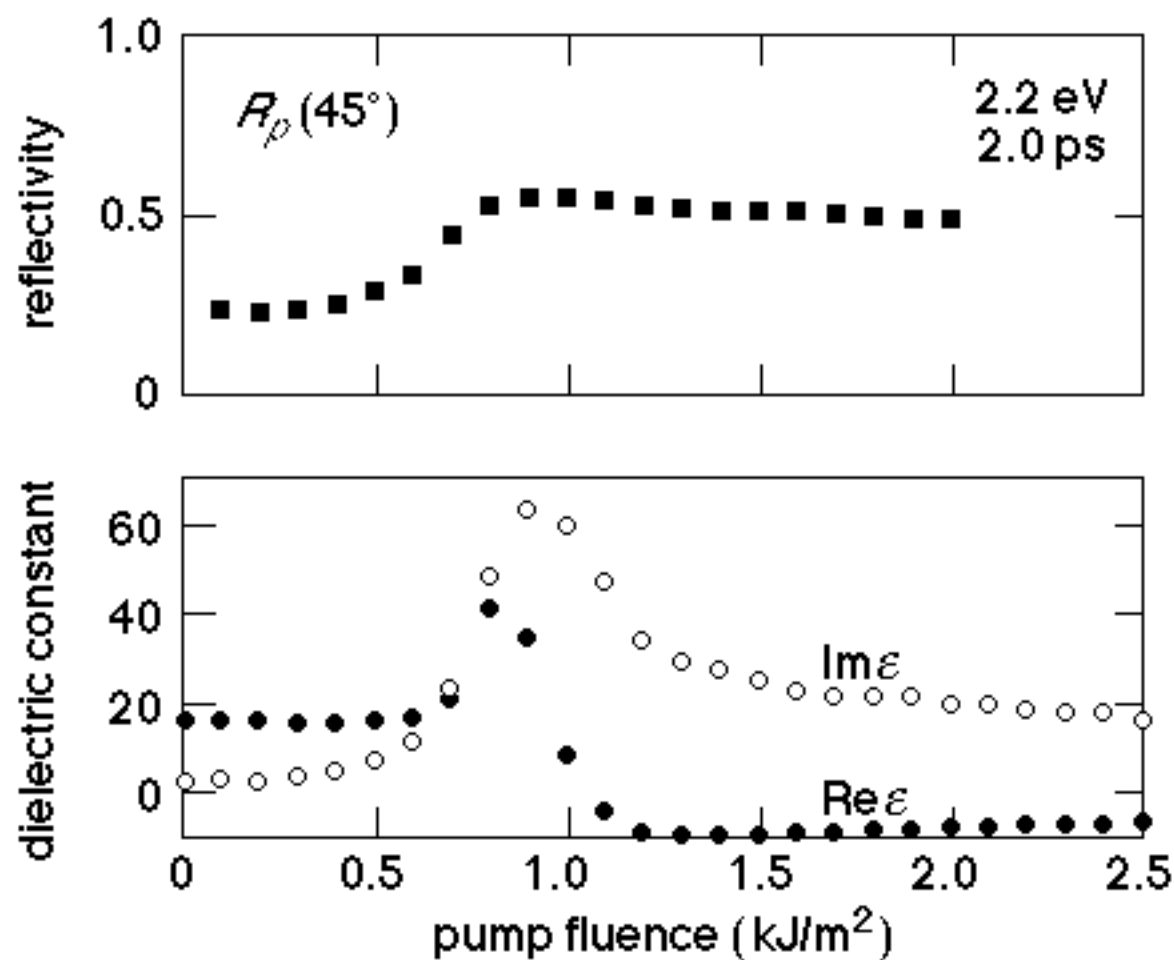

# ***SIMPLE MODEL***

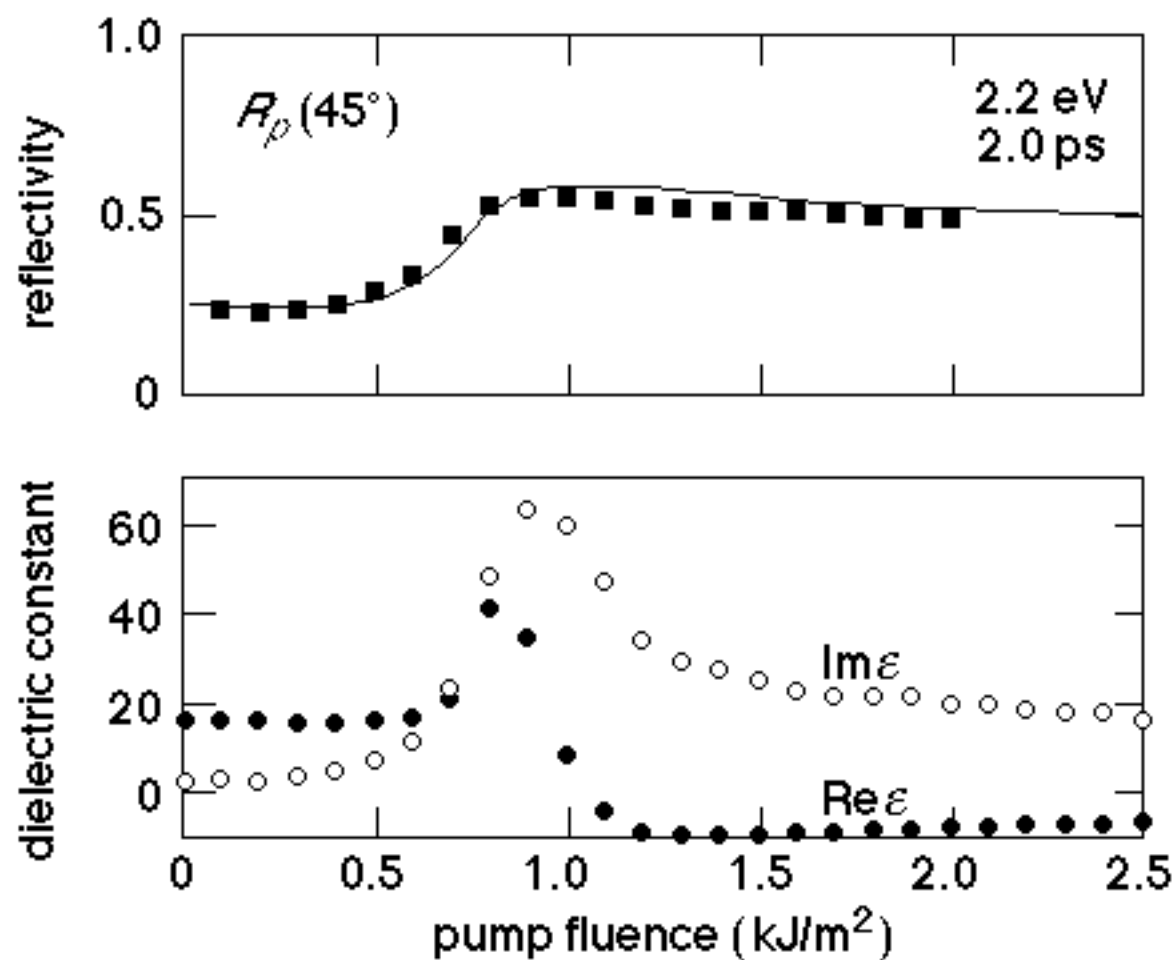

# WHAT IS HAPPENING?

structure

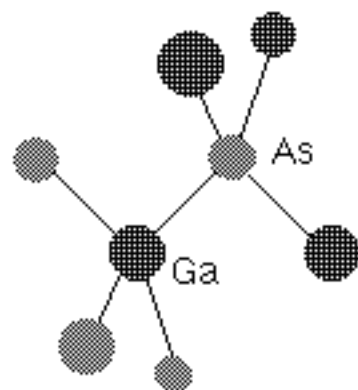

# *WHAT IS HAPPENING?*

structure

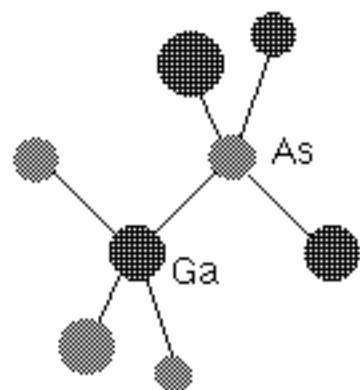

# WHAT IS HAPPENING?

structure

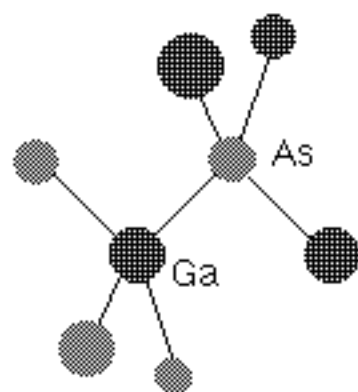

bandstructure

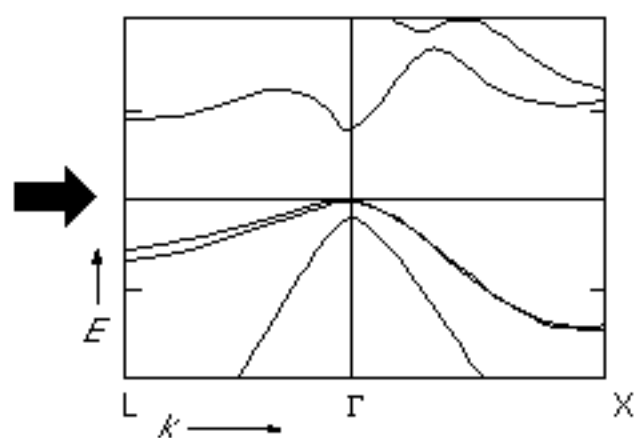

# WHAT IS HAPPENING?

structure

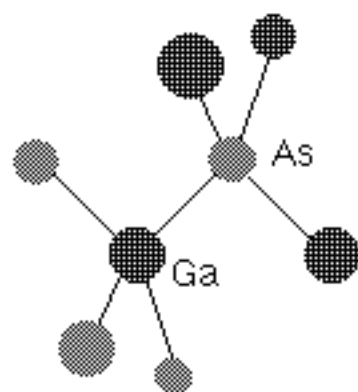

bandstructure

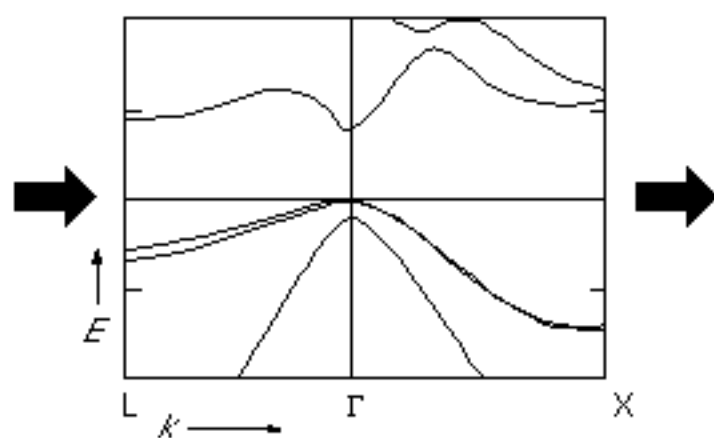



# WHAT IS HAPPENING?

structure

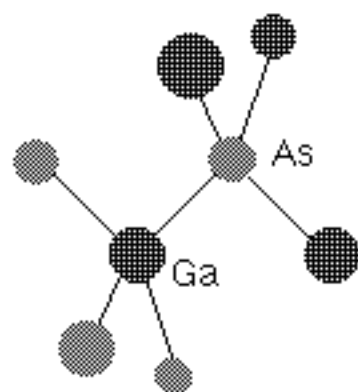

bandstructure

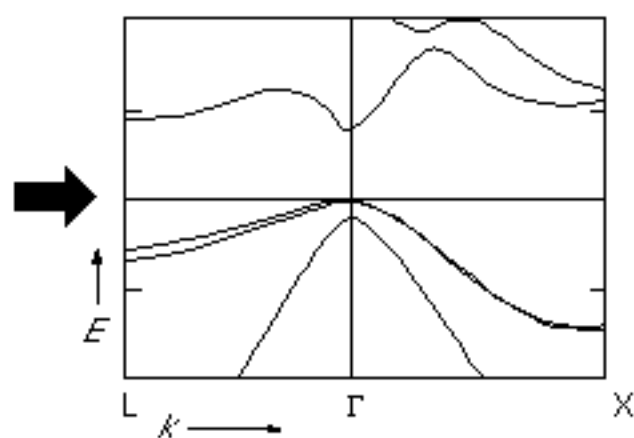

dielectric function

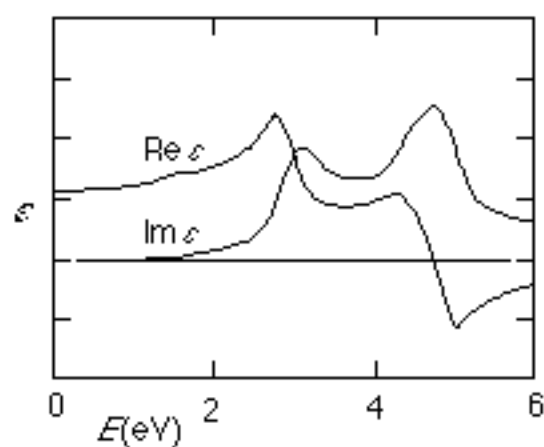

# WHAT IS HAPPENING?

structure

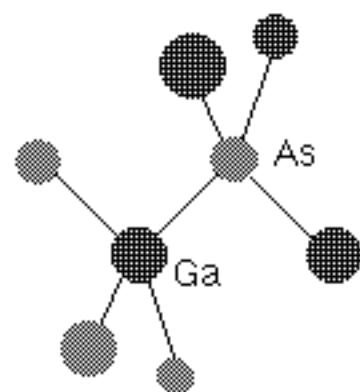

bandstructure

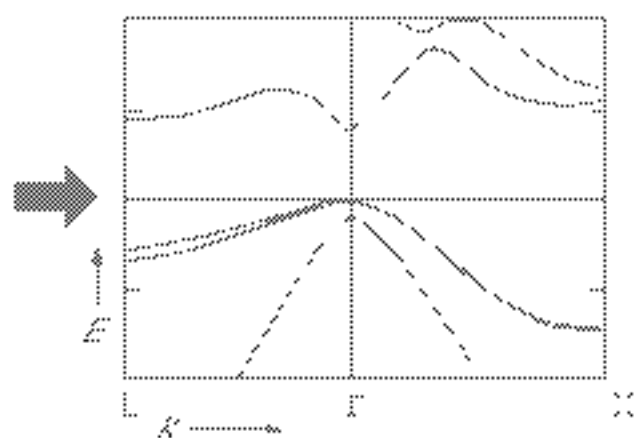

dielectric function

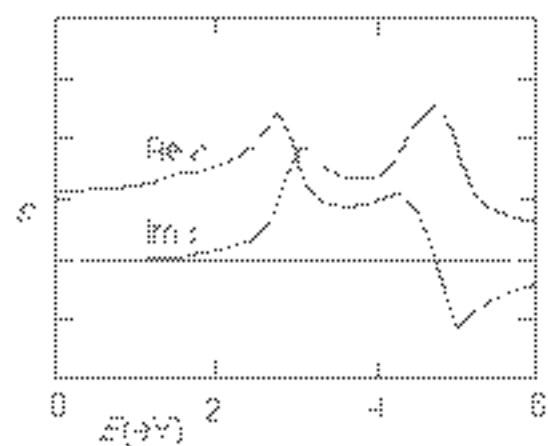

# WHAT IS HAPPENING?

structure

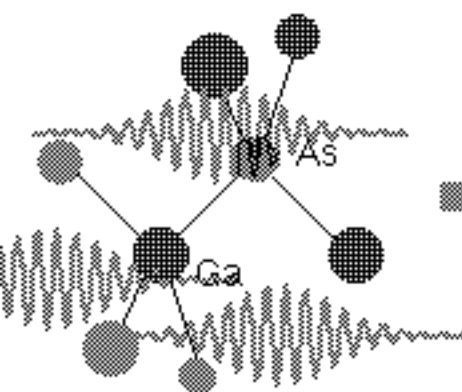

bandstructure

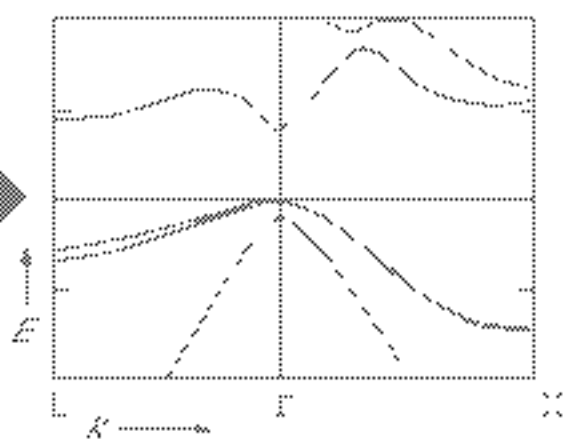

dielectric function

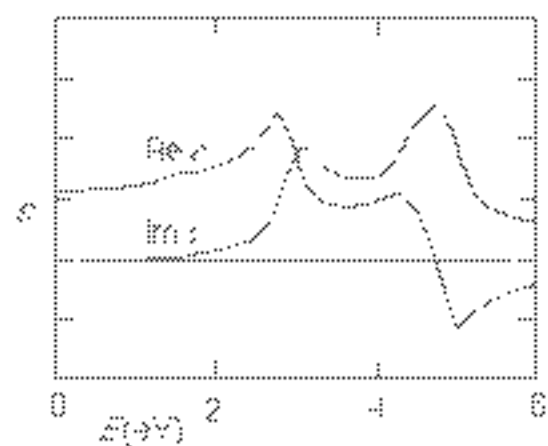

# WHAT IS HAPPENING?

structure

bandstructure

dielectric function

?

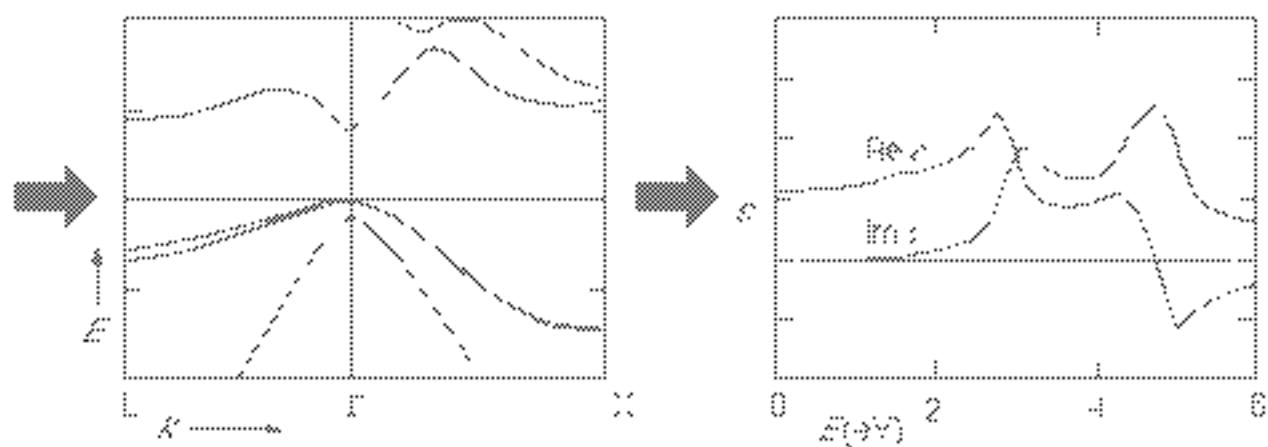

# WHAT IS HAPPENING?

structure

bandstructure

dielectric function

?

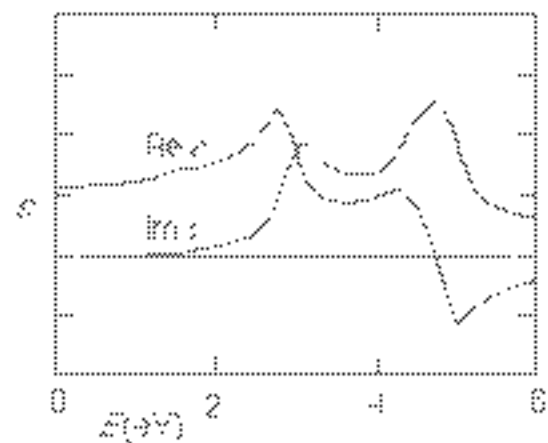
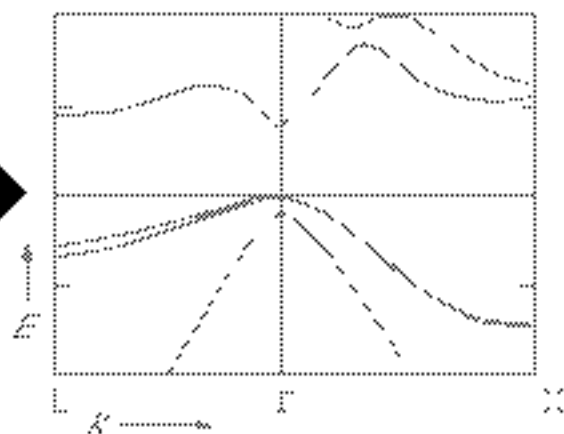

# WHAT IS HAPPENING?

structure

?



bandstructure

?



dielectric function

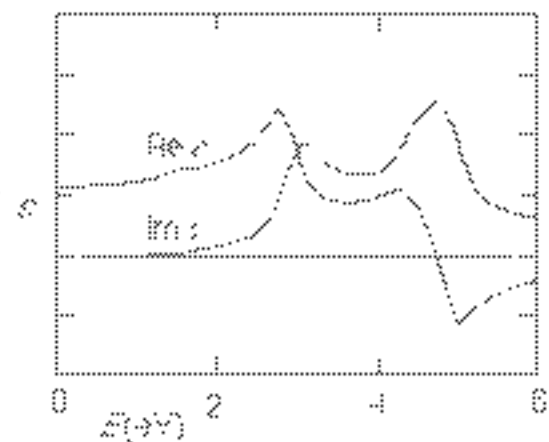
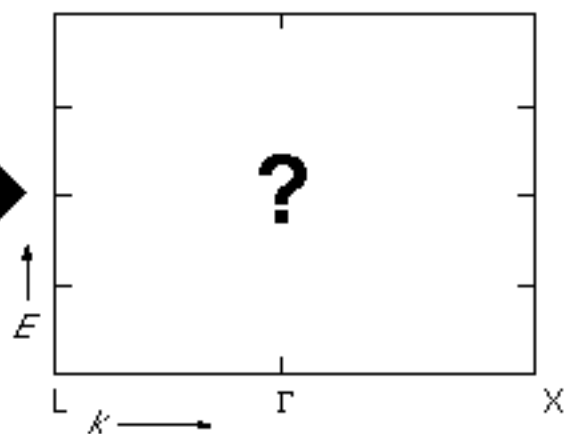

# WHAT IS HAPPENING?

structure

?



bandstructure

?



dielectric function

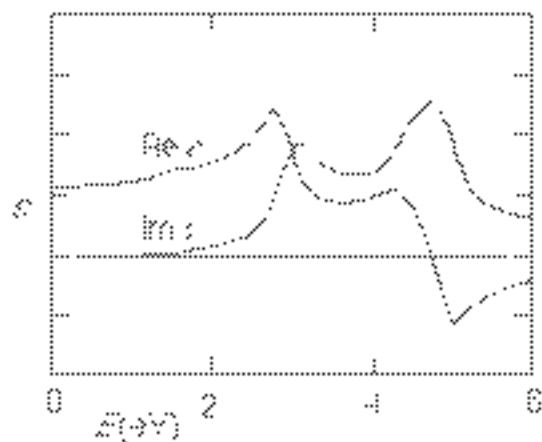
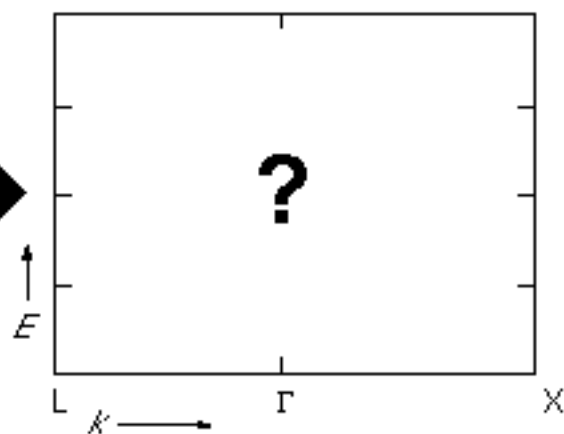

# WHAT IS HAPPENING?

structure

?



bandstructure

?



dielectric function

?

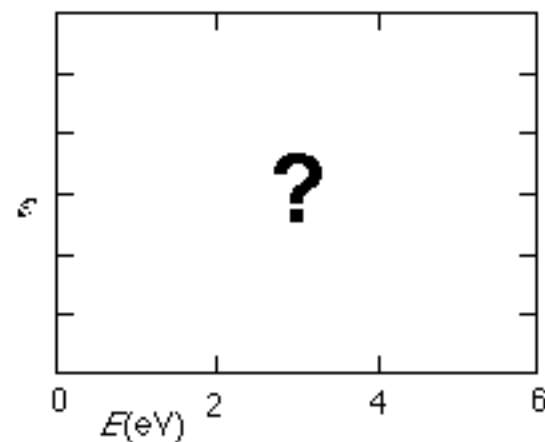
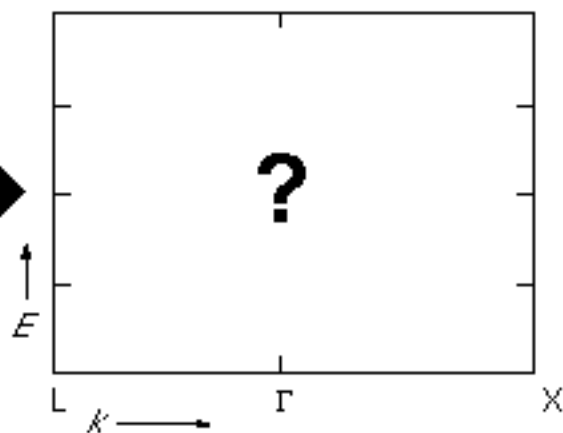



# WHAT IS HAPPENING?

structure

?

bandstructure

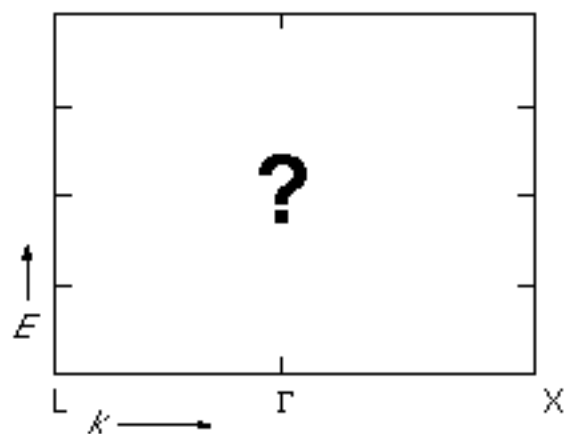

dielectric function

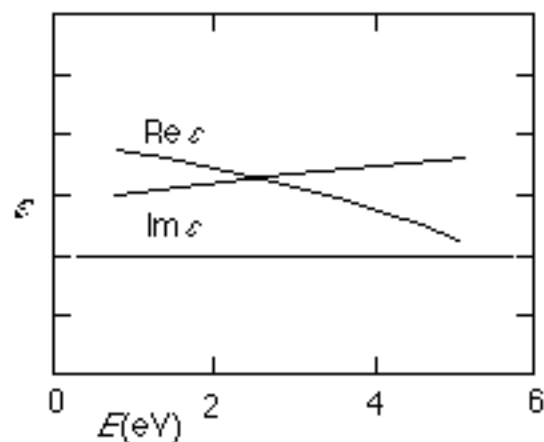

# WHAT IS HAPPENING?

structure

?

bandstructure

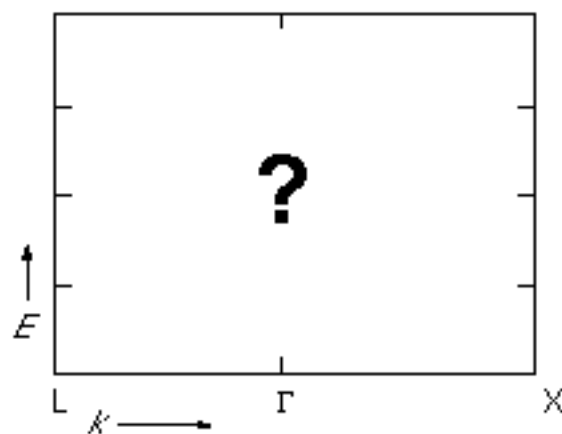

dielectric function

$\epsilon$

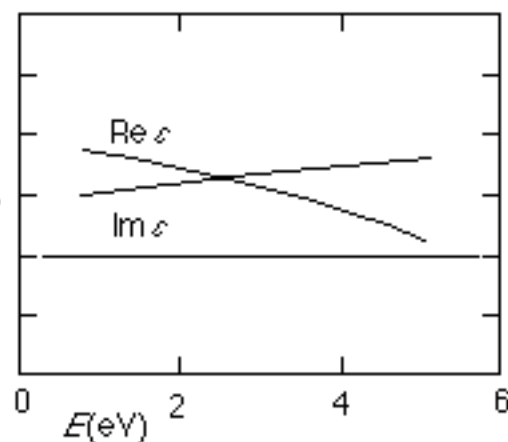

# WHAT IS HAPPENING?

structure

bandstructure

dielectric function

?

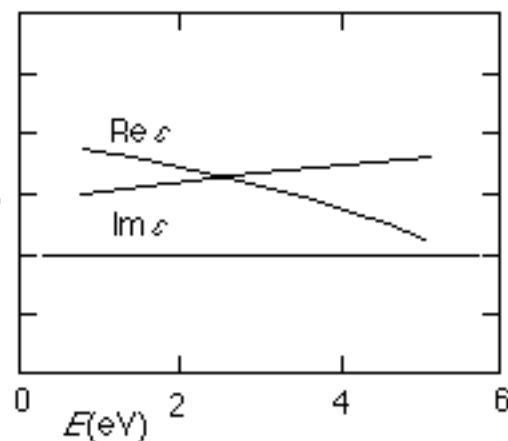
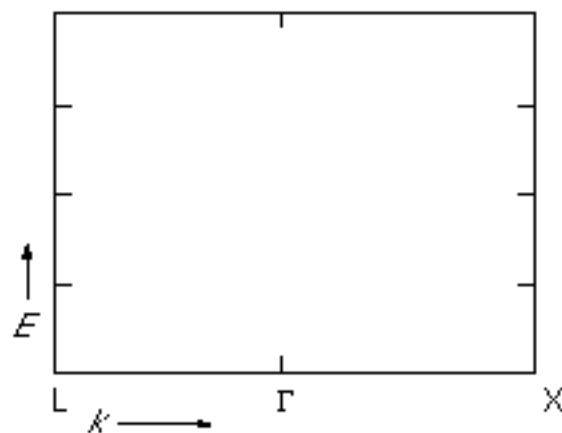

# WHAT IS HAPPENING?

structure

bandstructure

dielectric function

?

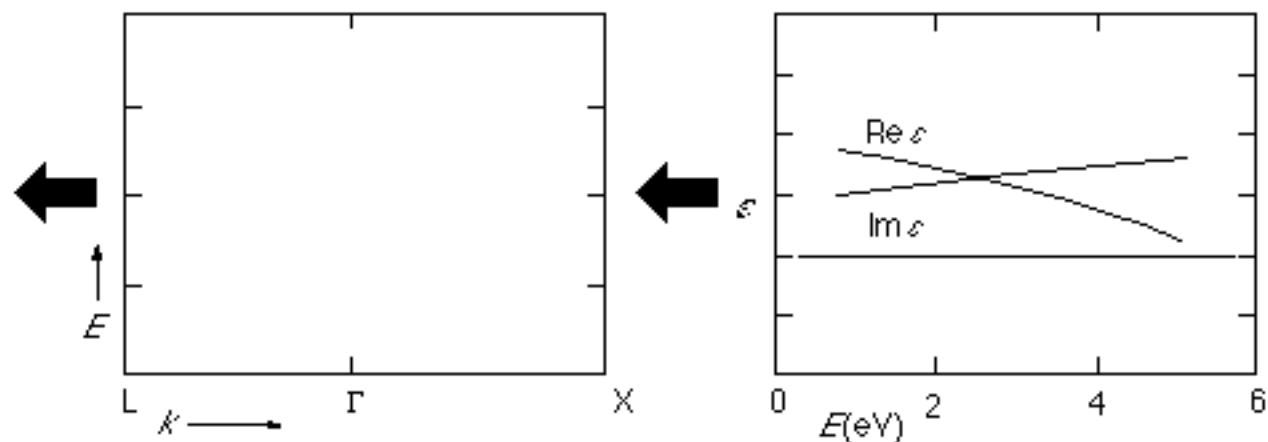

# WHAT IS HAPPENING?

structure

bandstructure

dielectric function

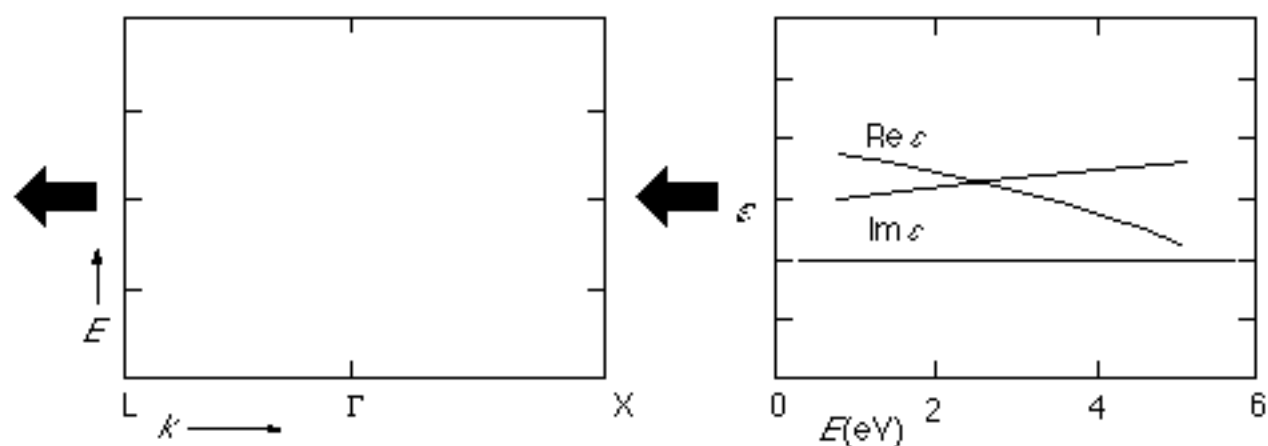

# *GaAs BANDSTRUCTURE*

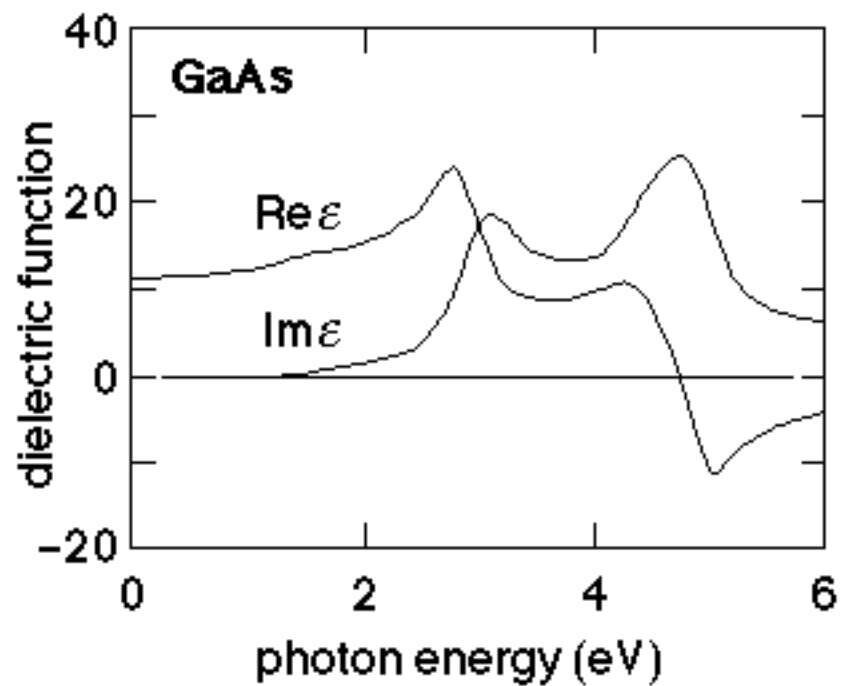
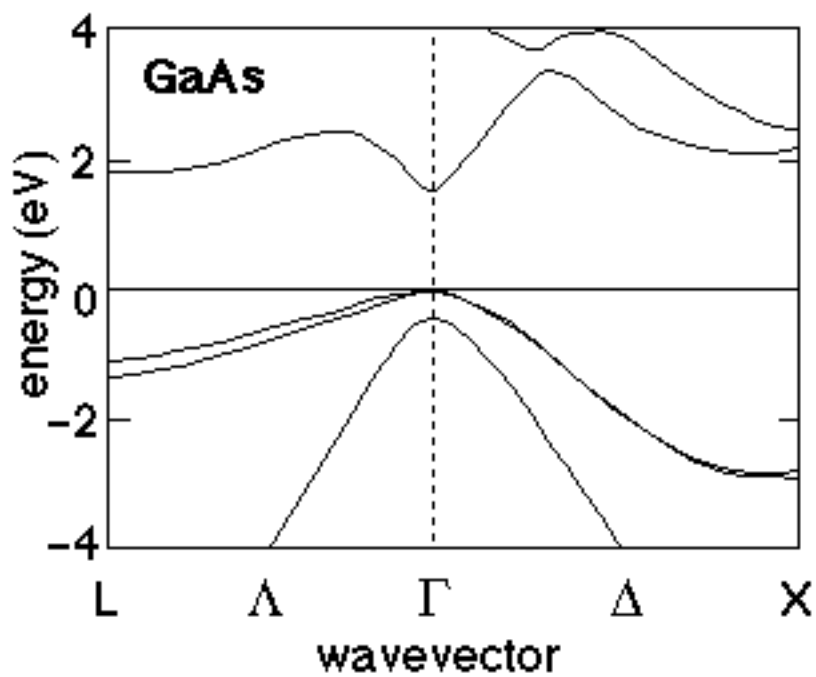

# *GaAs BANDSTRUCTURE*

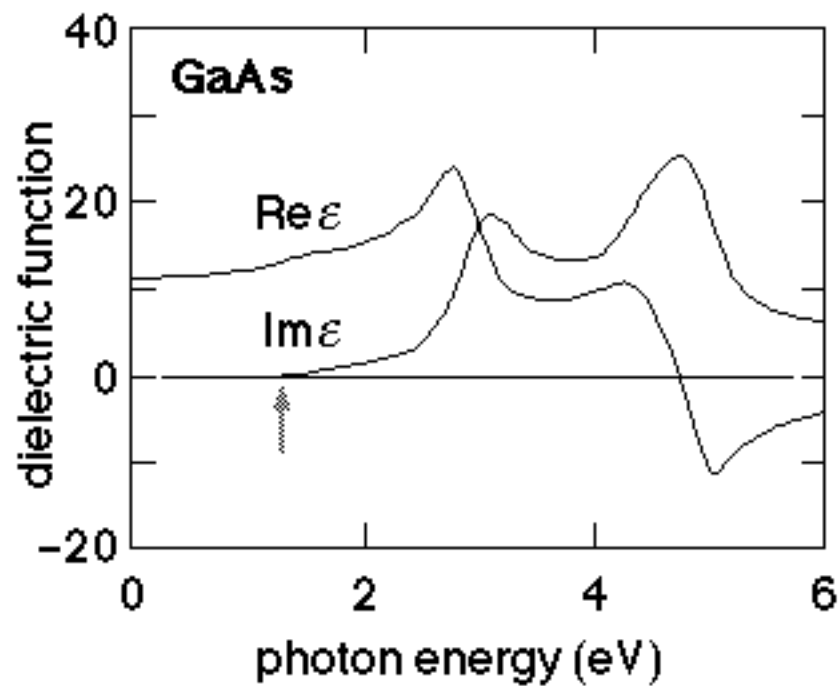
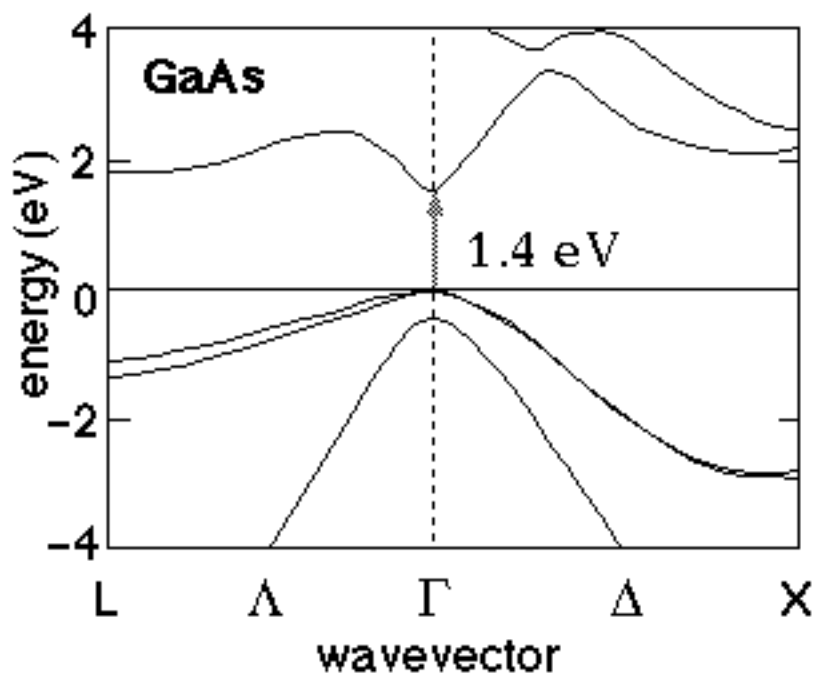

# GaAs BANDSTRUCTURE

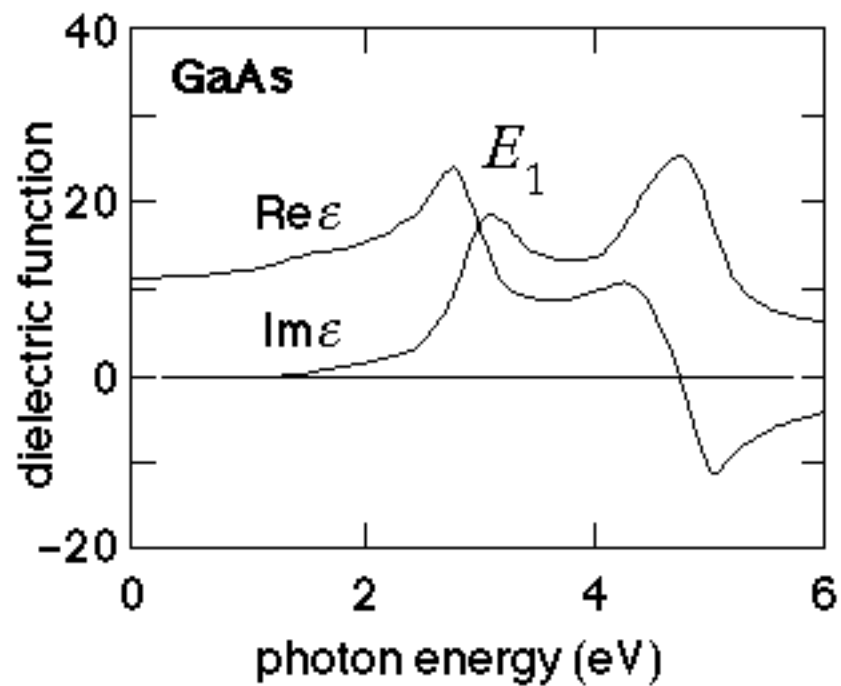
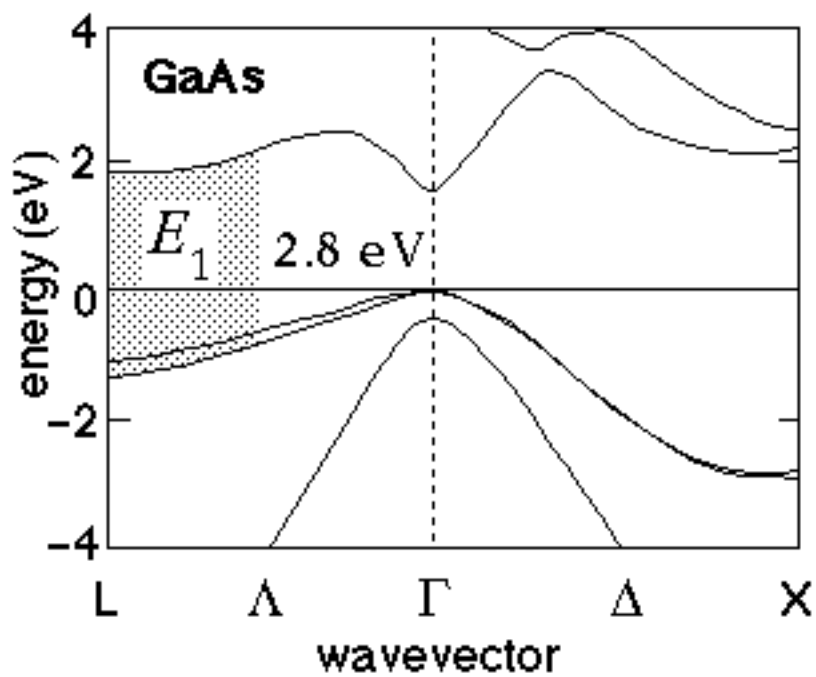



# *GaAs BANDSTRUCTURE*

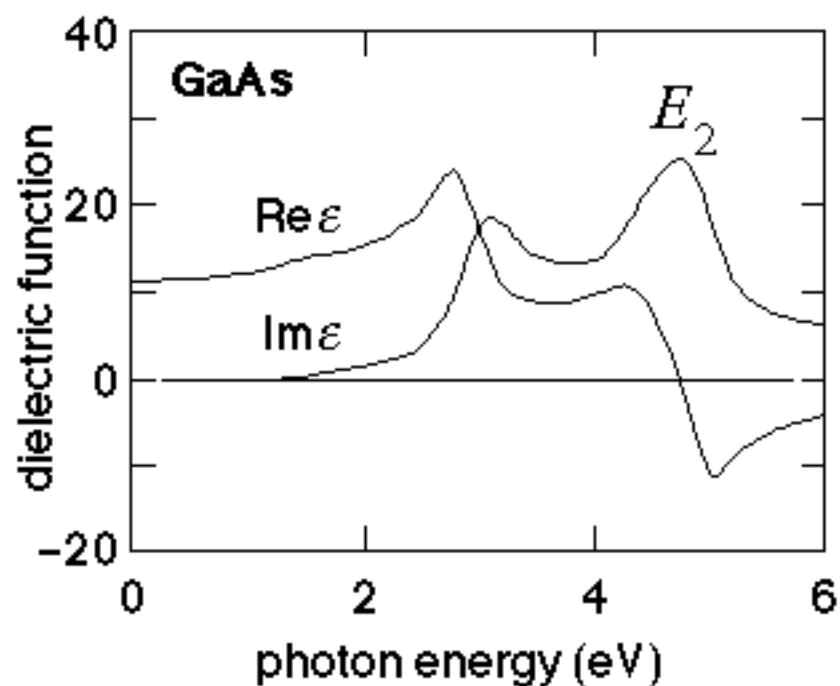
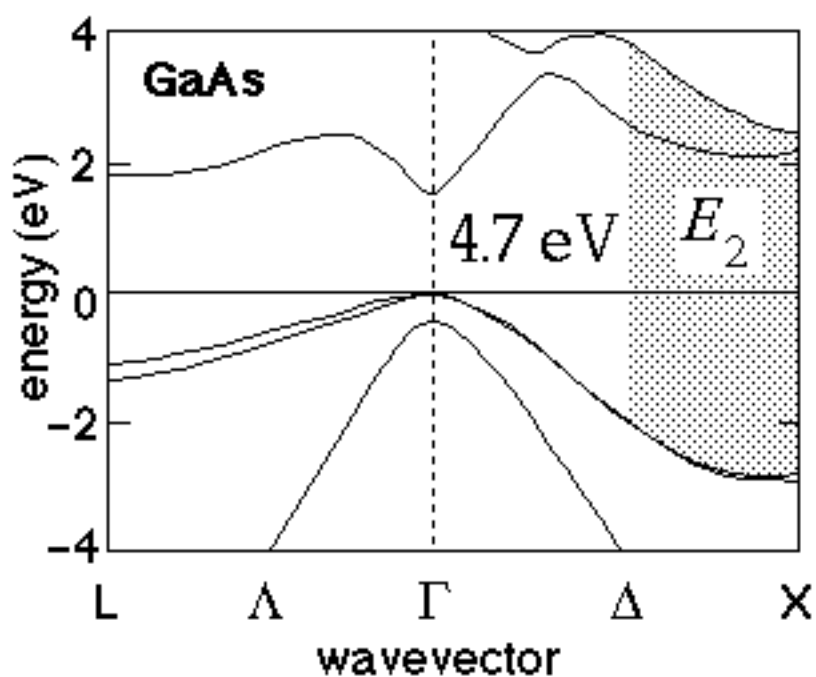

# GaAs BANDSTRUCTURE

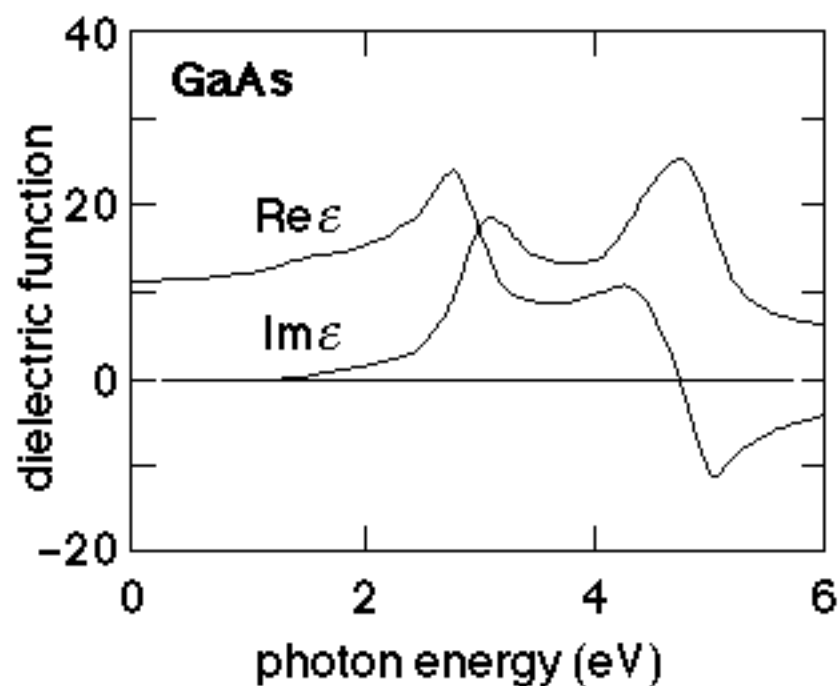
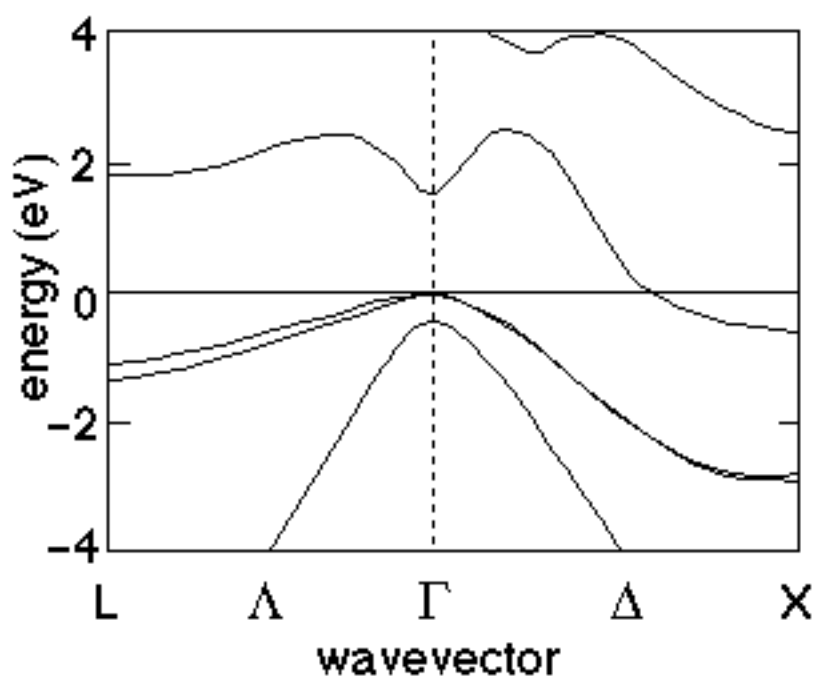

S. Froyen *et al.*, *Phys Rev. B* **28** (1983) 3258

D.H. Kim *et al.*, *Sol. State. Comm.* **89** (1994) 119



# ***BROADBAND PROBE***

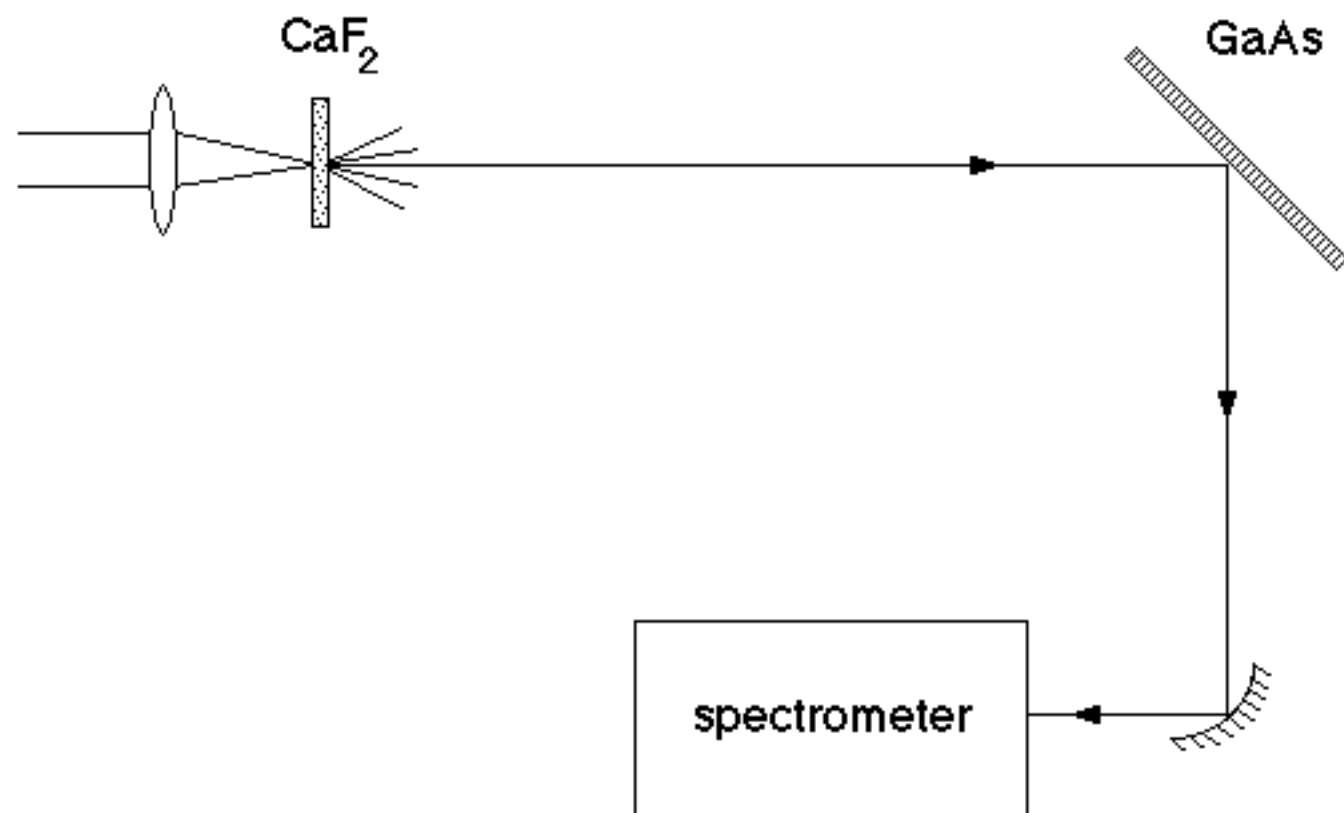

# *BROADBAND PROBE*

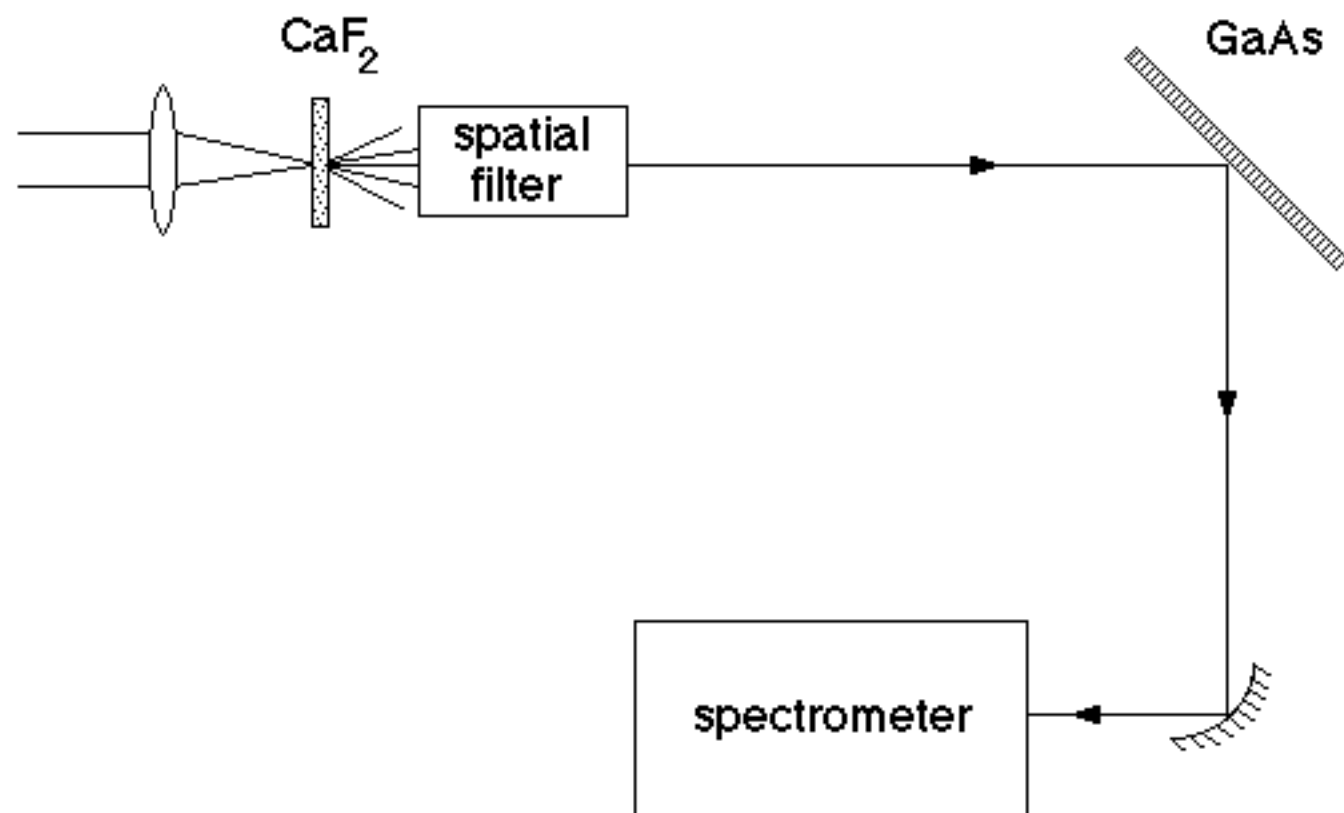

# *BROADBAND PROBE*

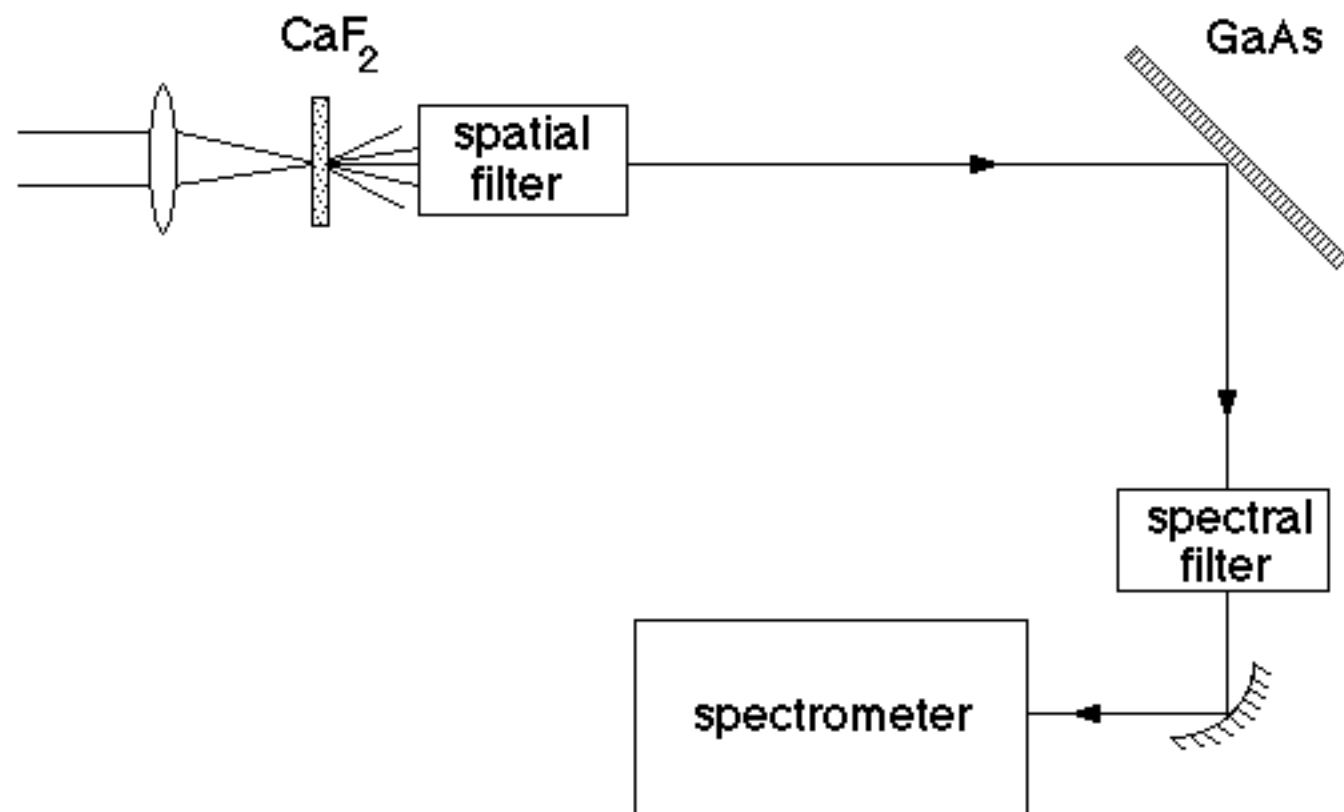

# ***BROADBAND PROBE***

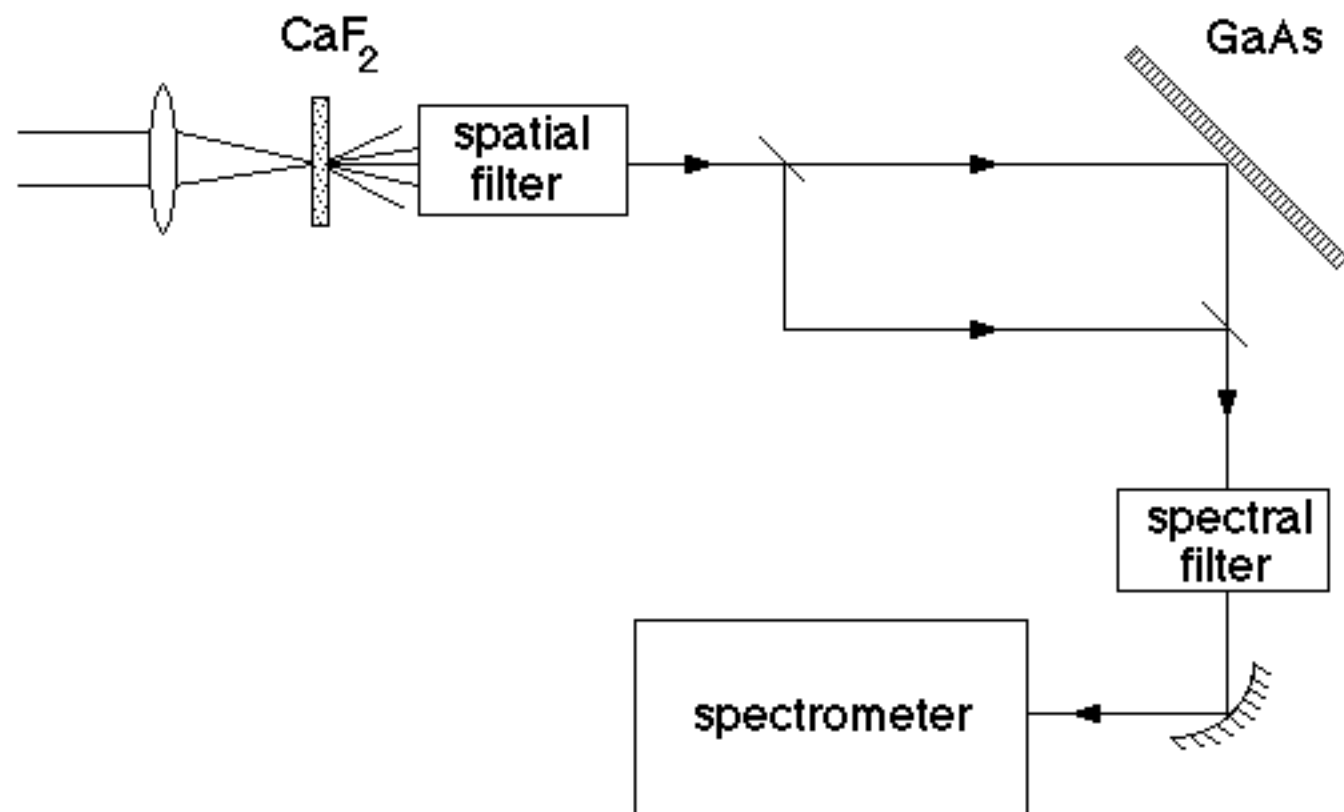

# WHITE LIGHT SPECTRUM

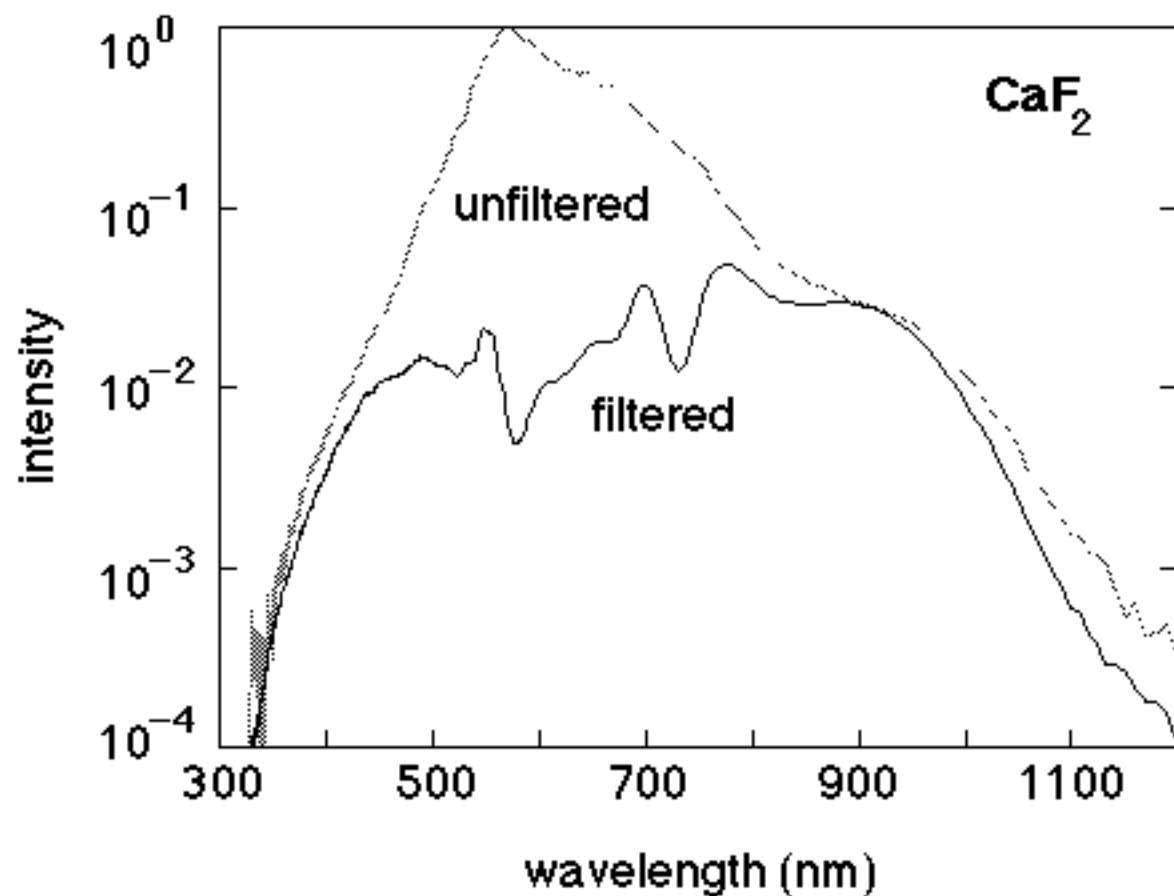

# BROADBAND DATA

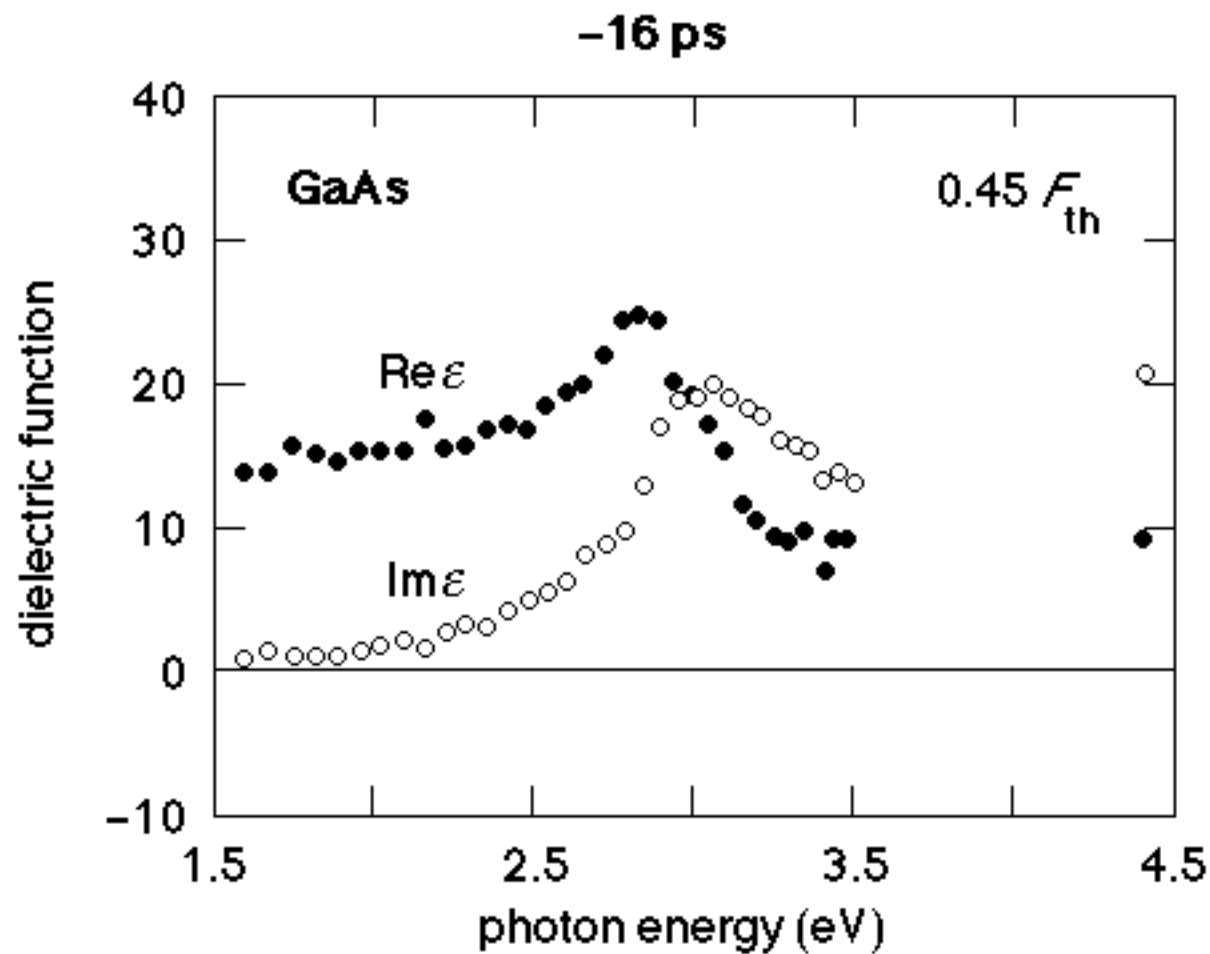



# BROADBAND DATA

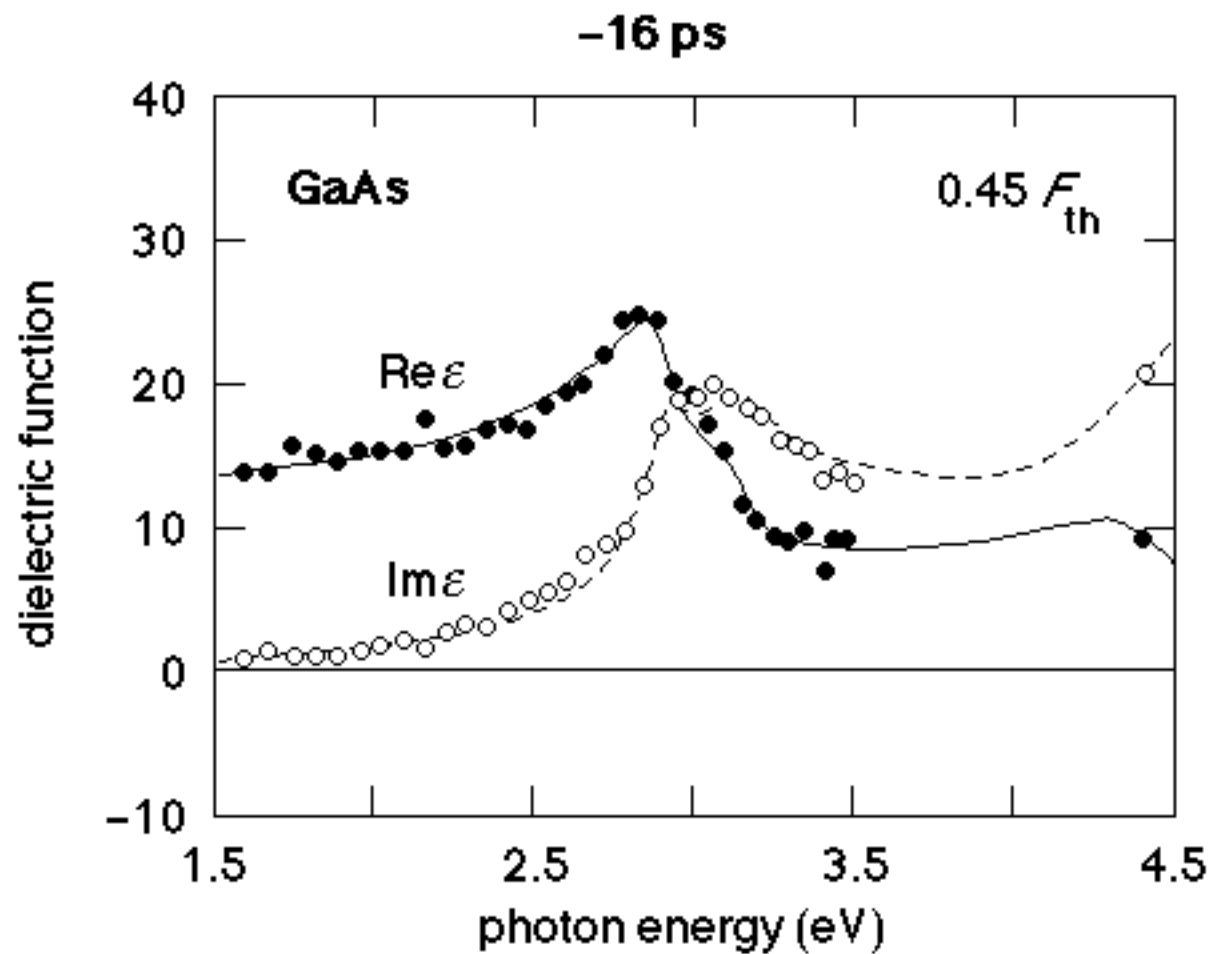

# BROADBAND DATA

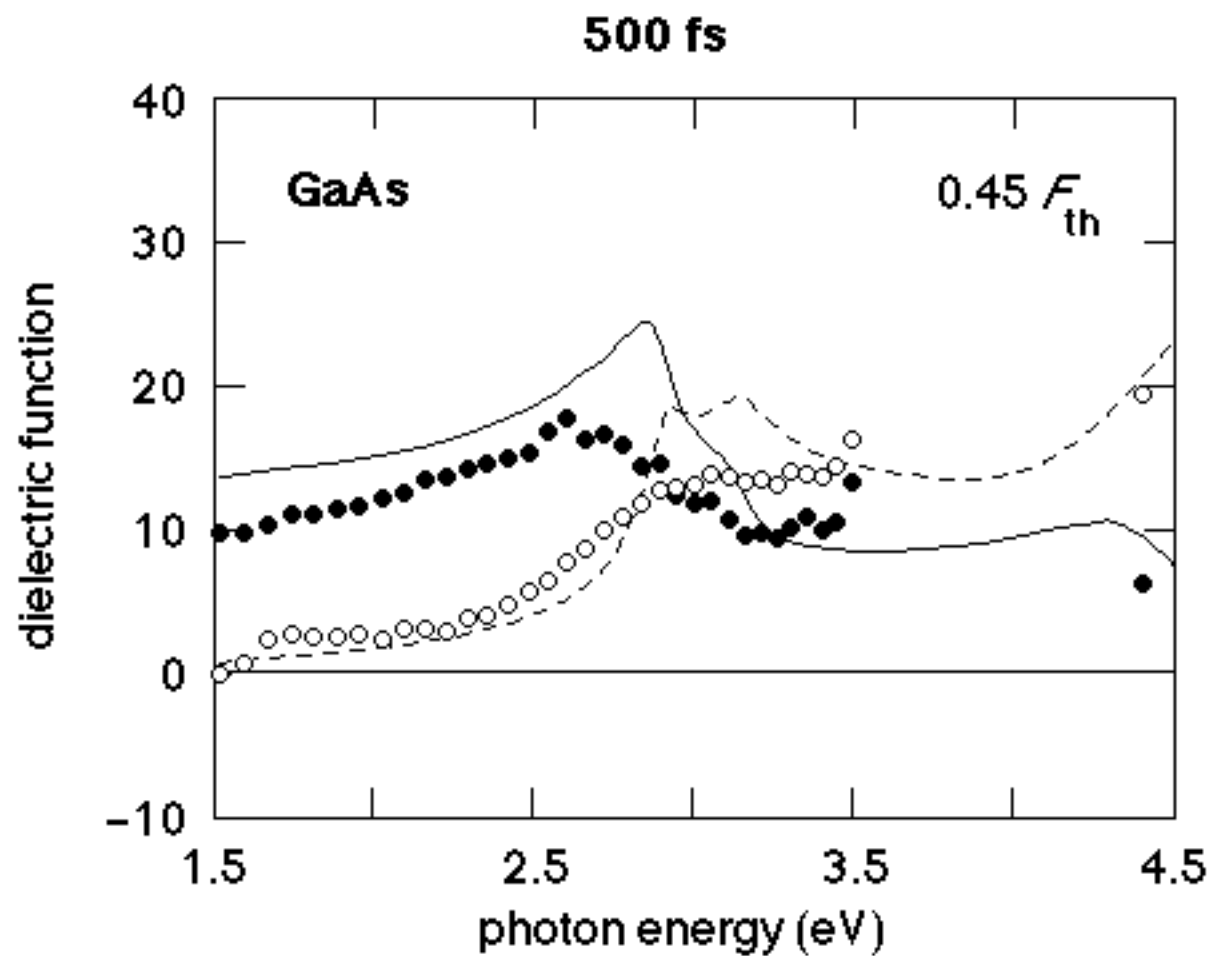

# BROADBAND DATA

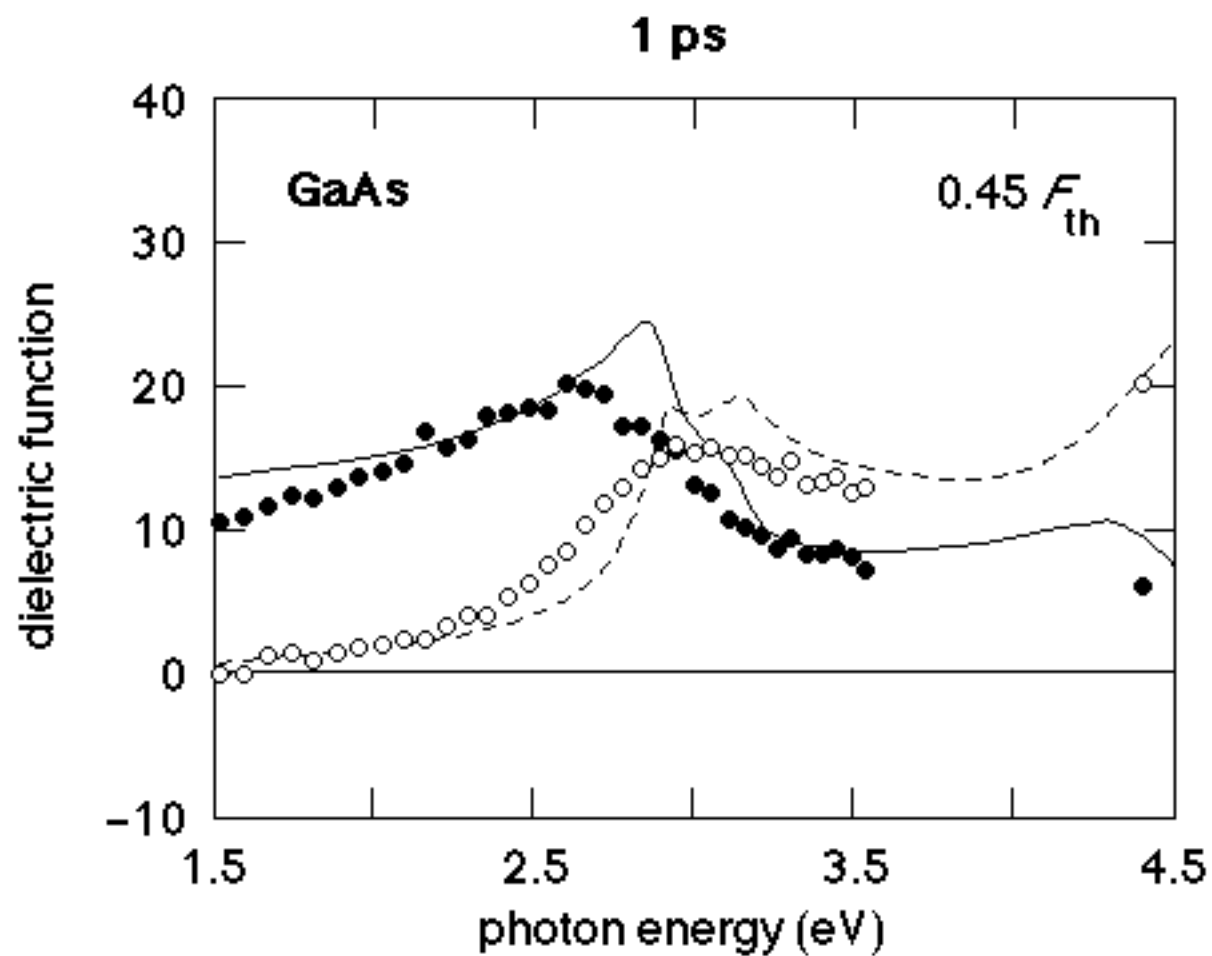

# BROADBAND DATA

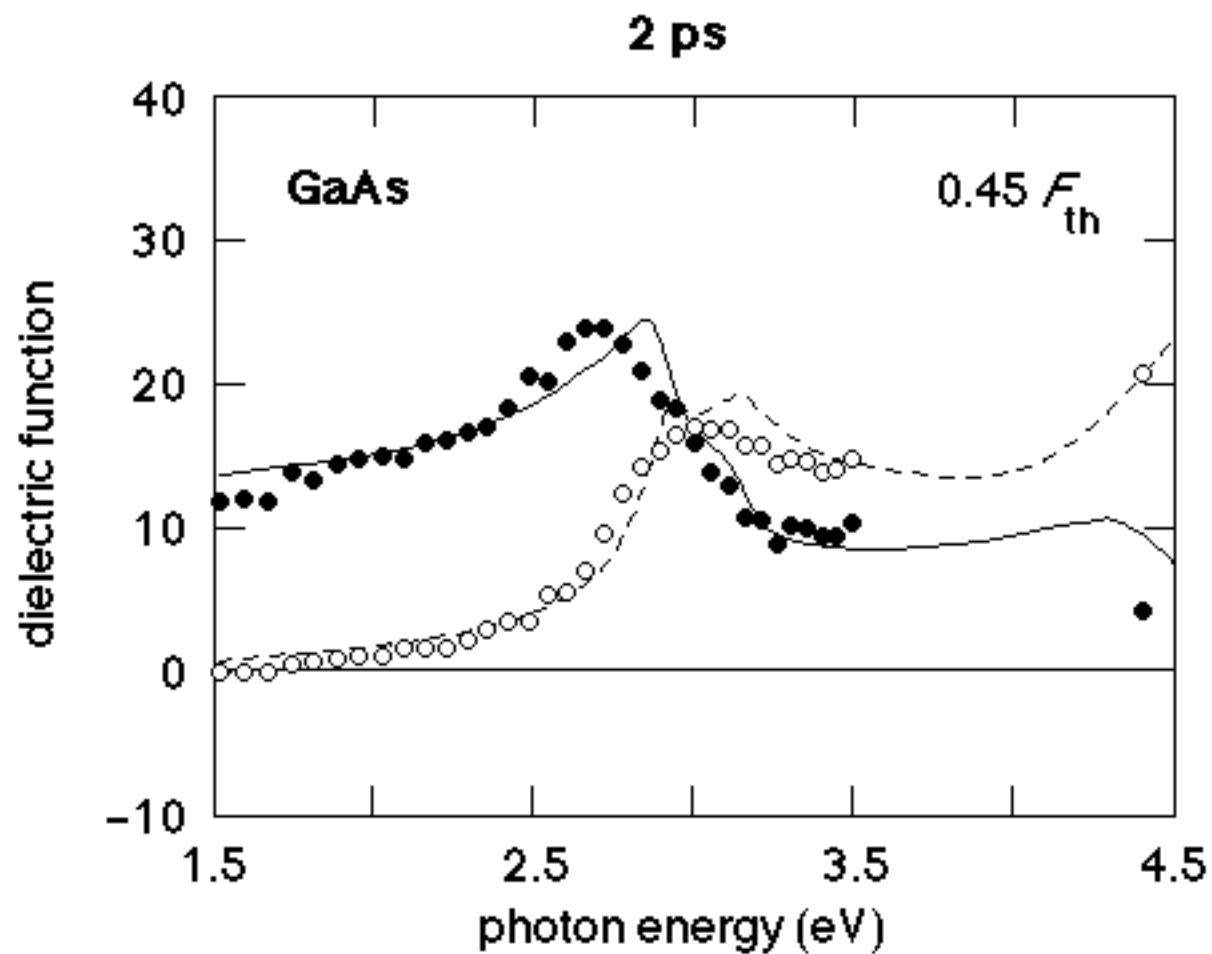

# BROADBAND DATA

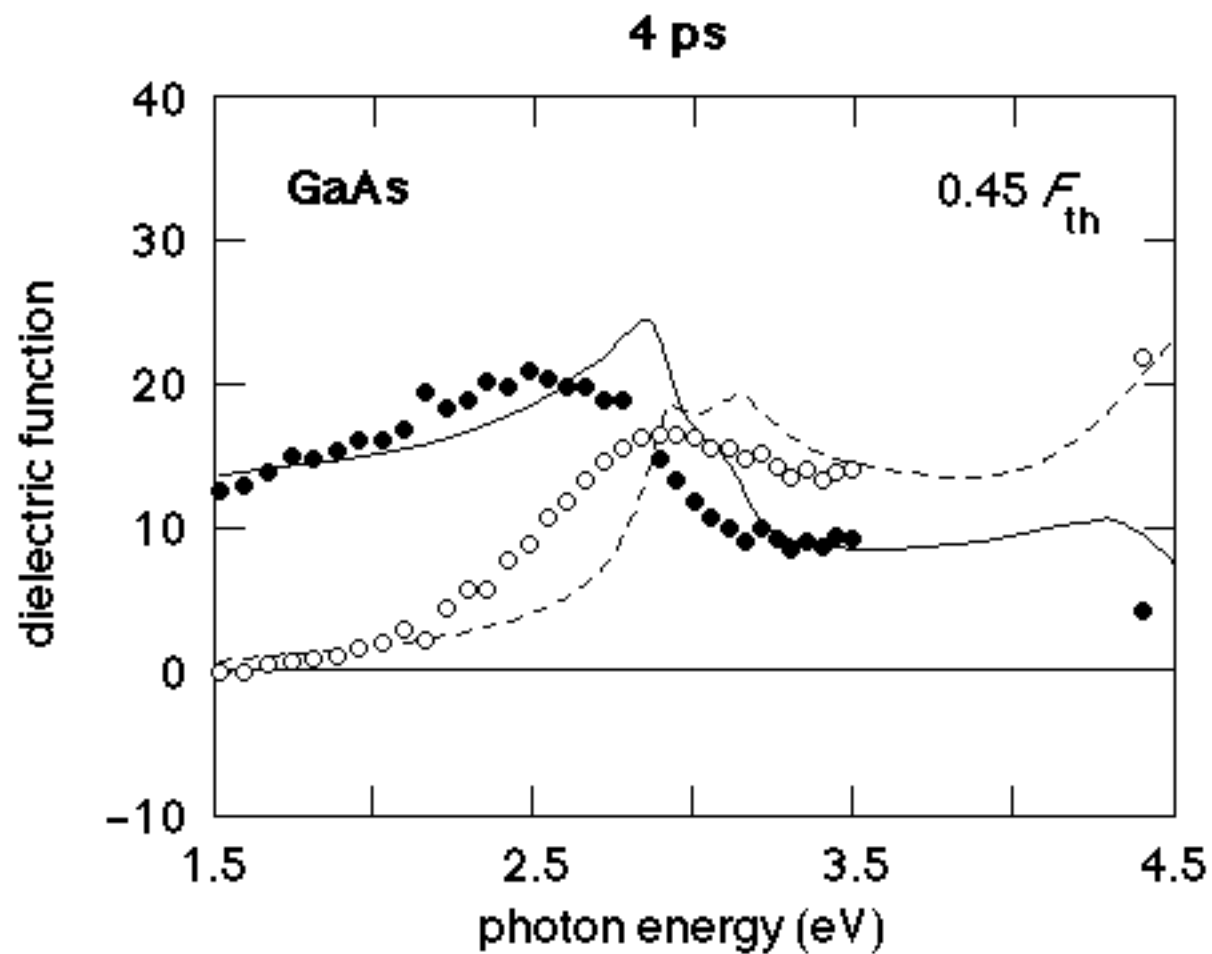

# BROADBAND DATA

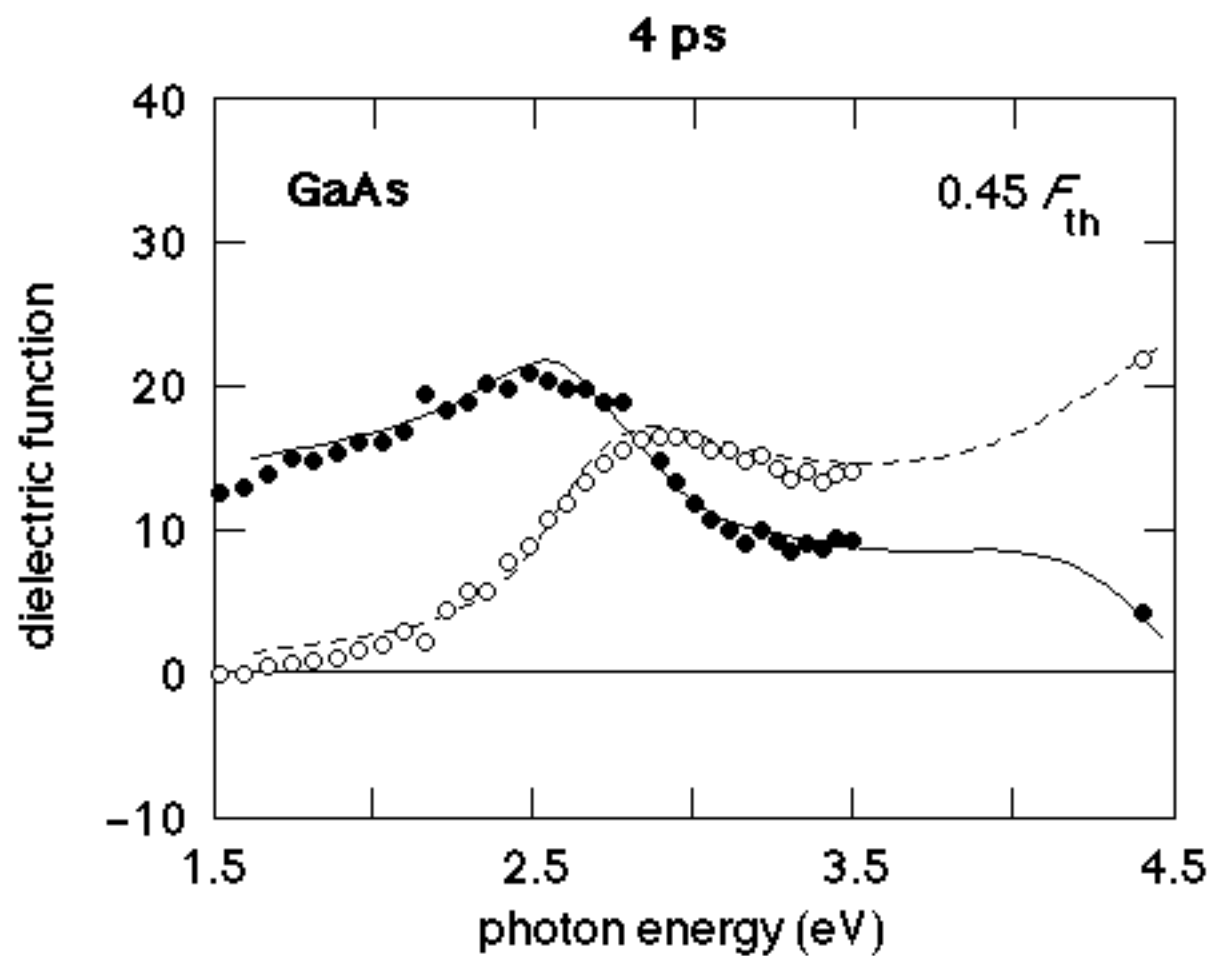

# BROADBAND DATA

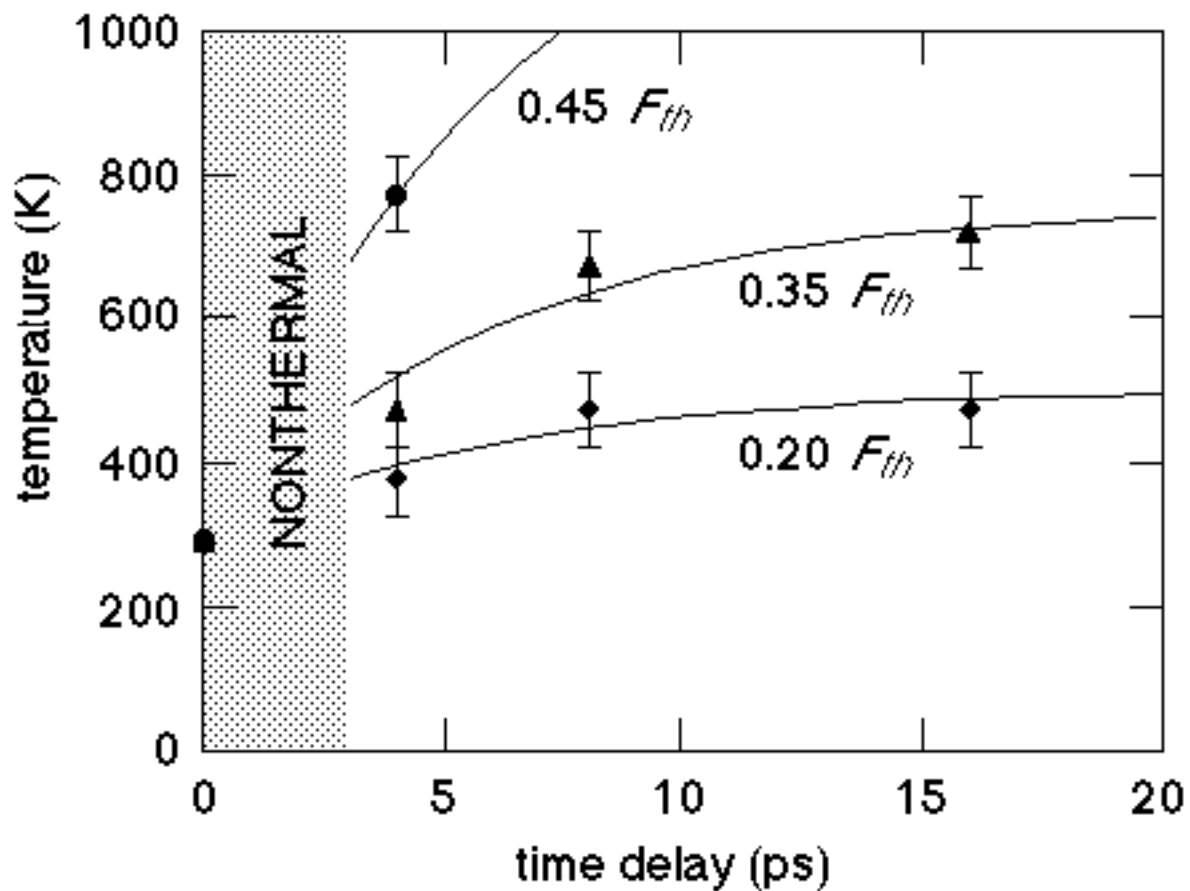

# BROADBAND DATA

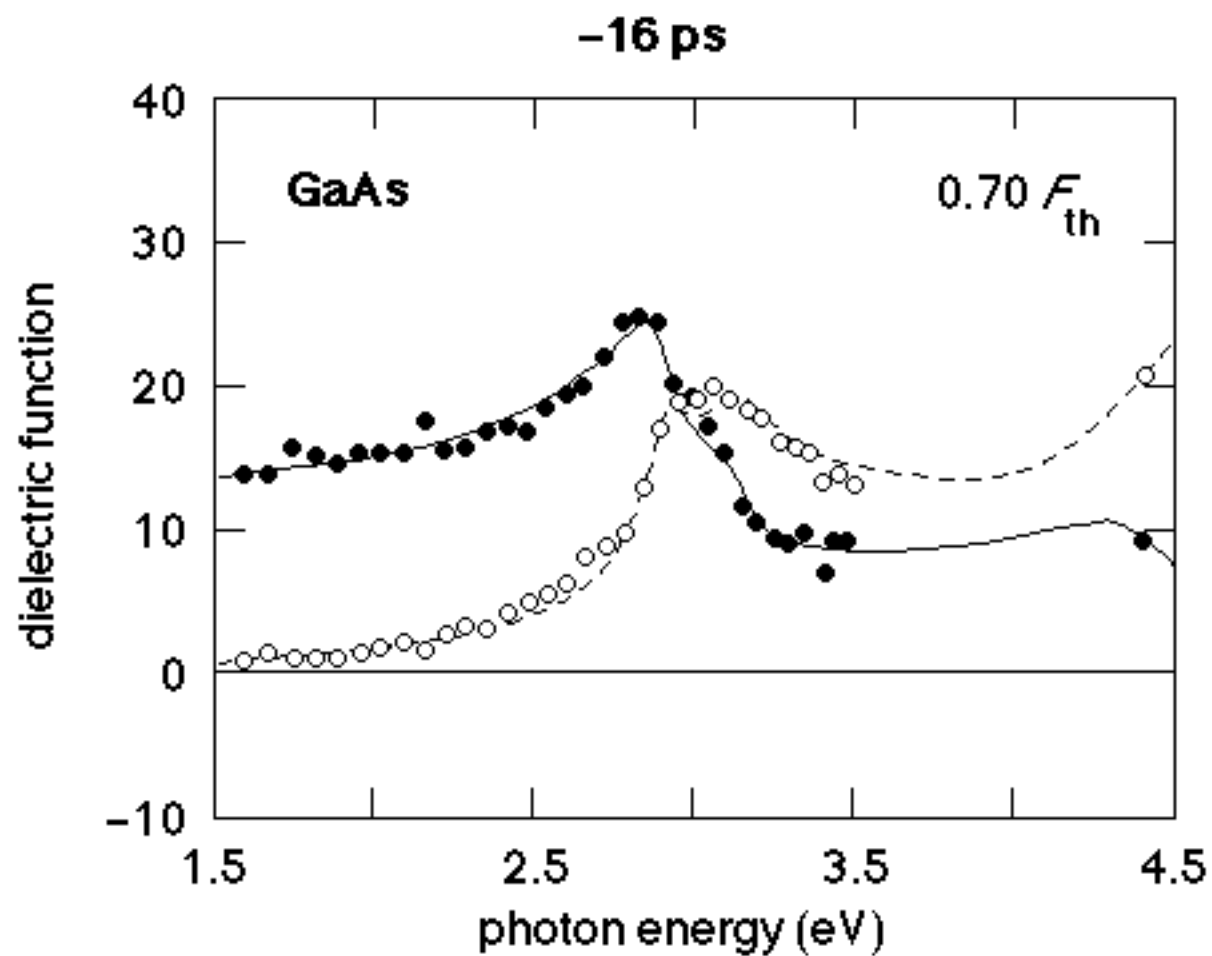



# BROADBAND DATA

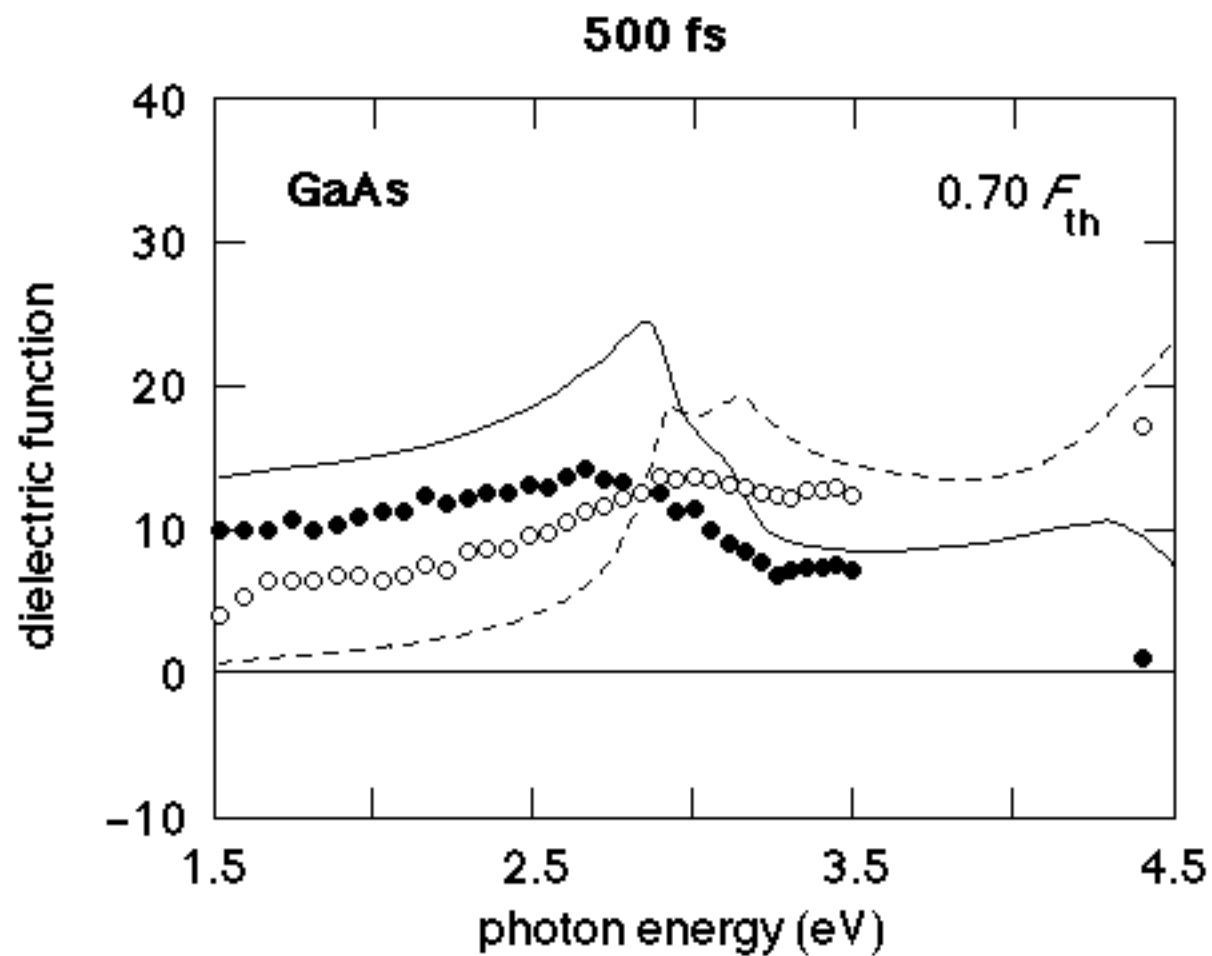

# BROADBAND DATA

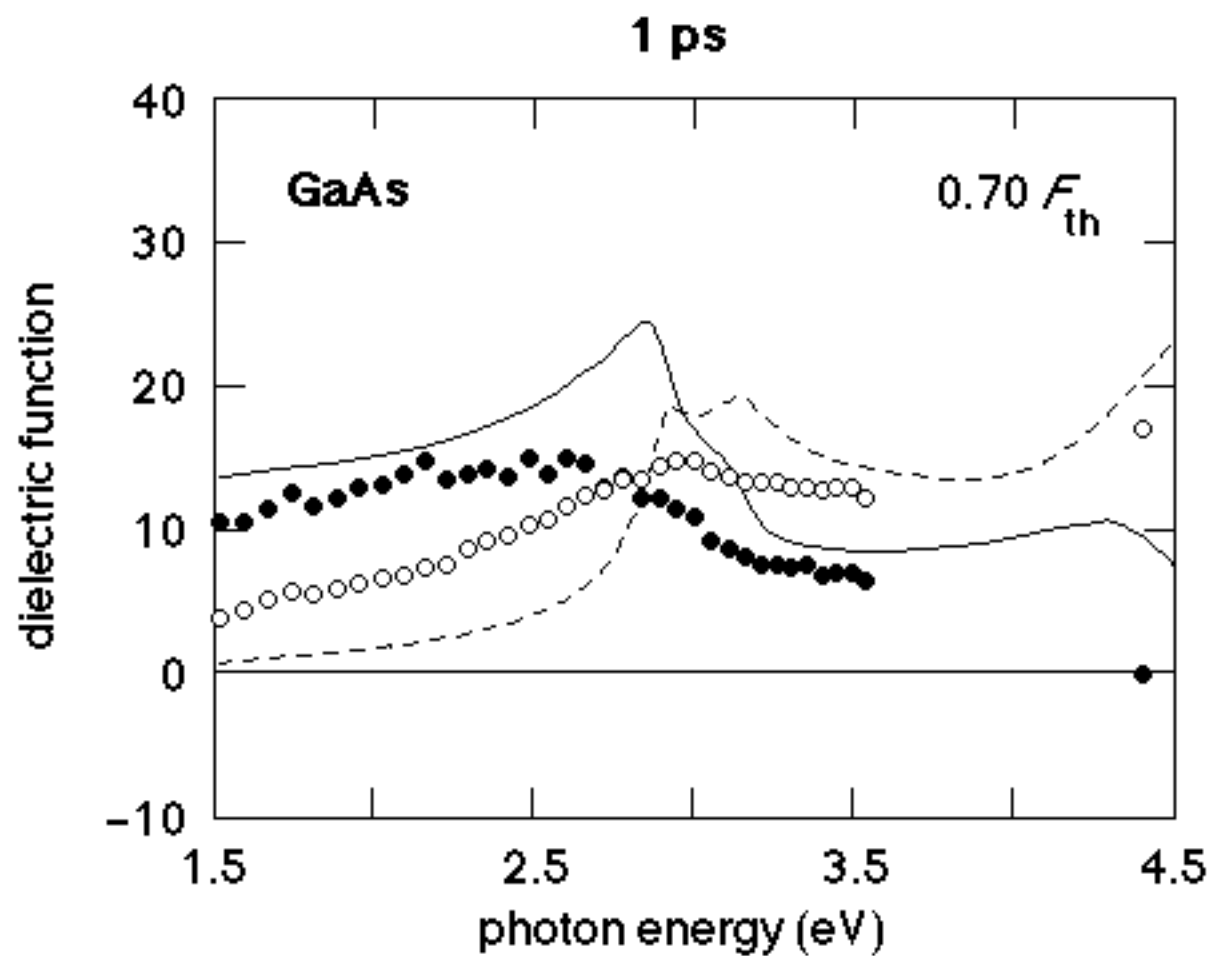

# BROADBAND DATA

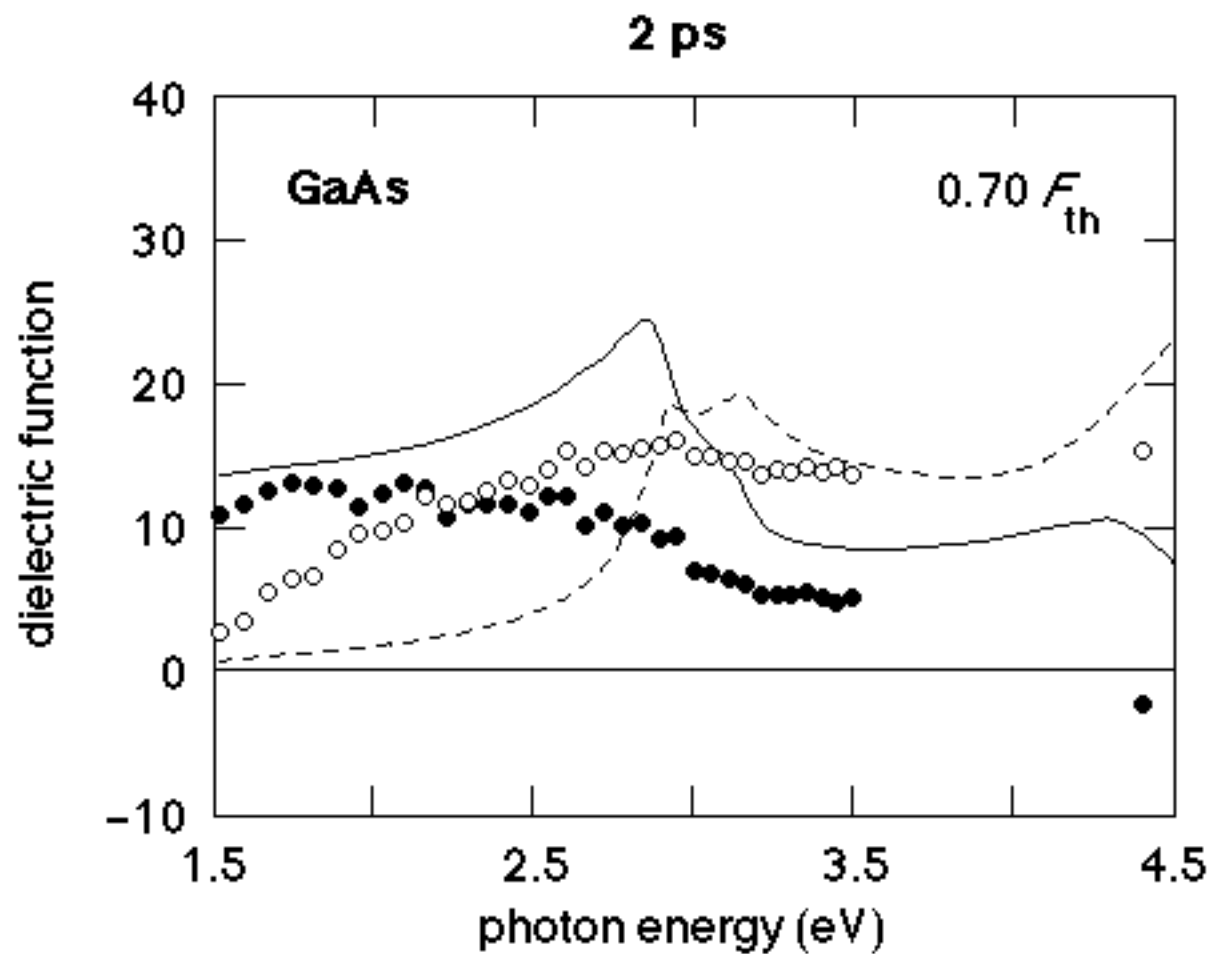

# BROADBAND DATA

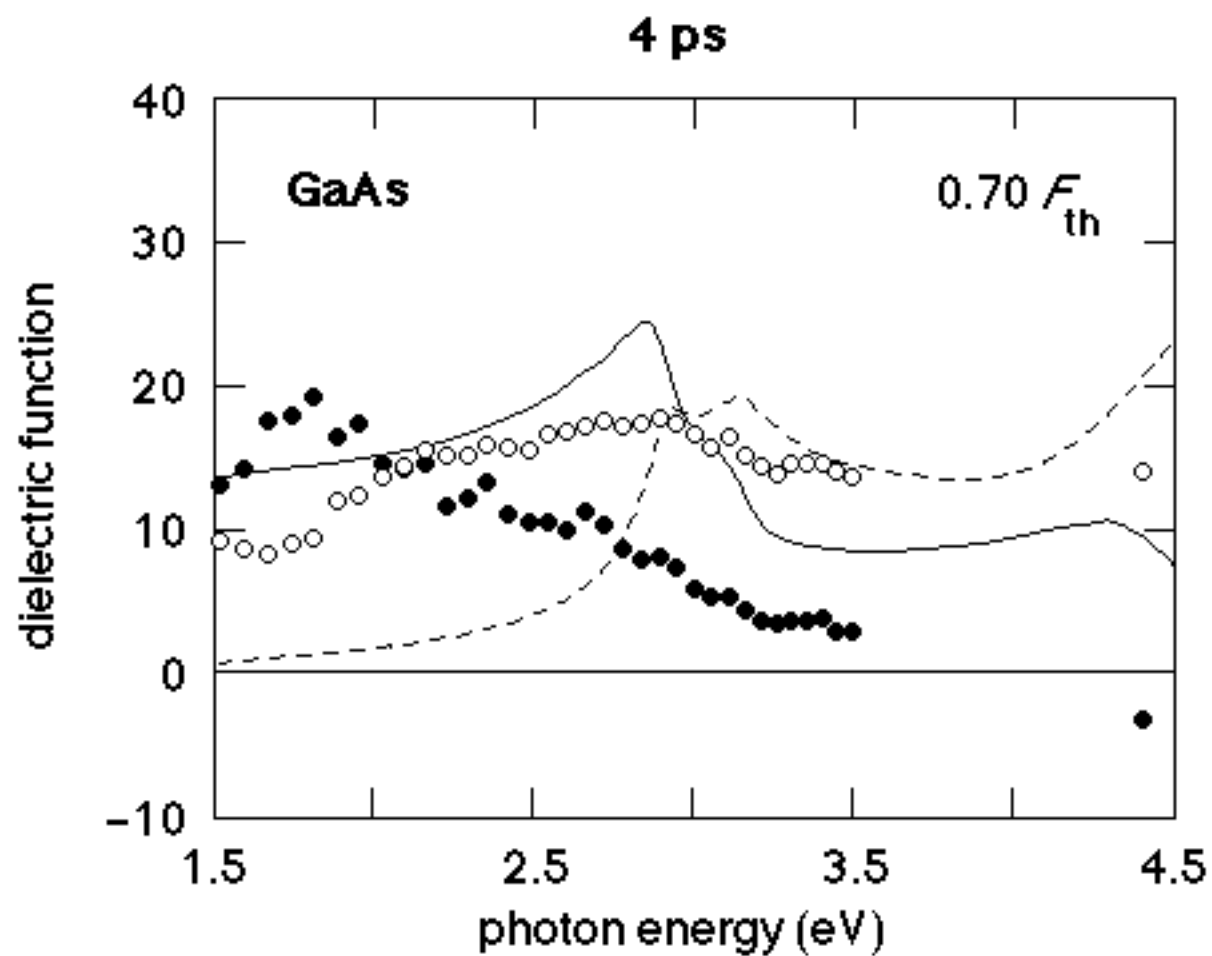

# BROADBAND DATA

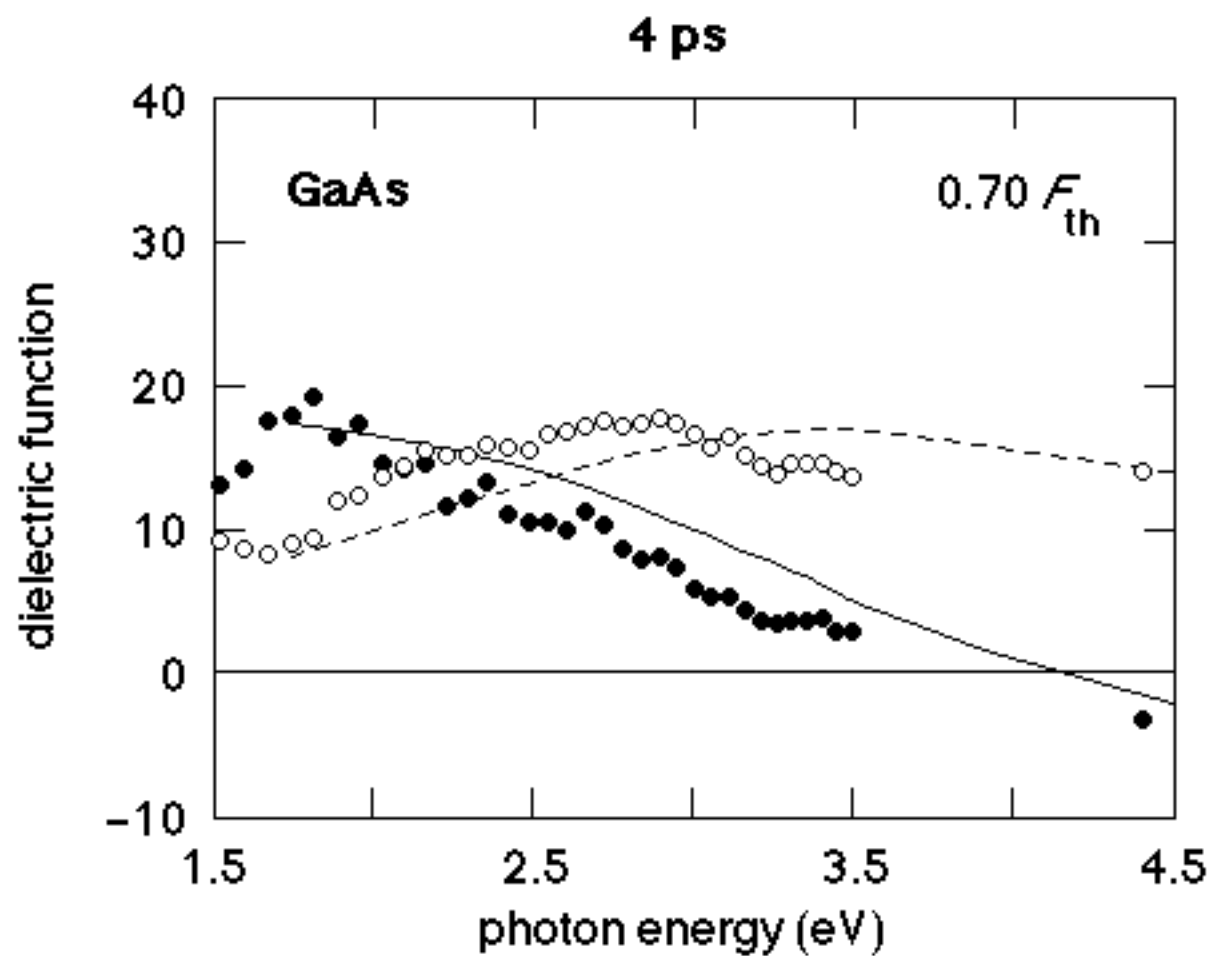

# BROADBAND DATA

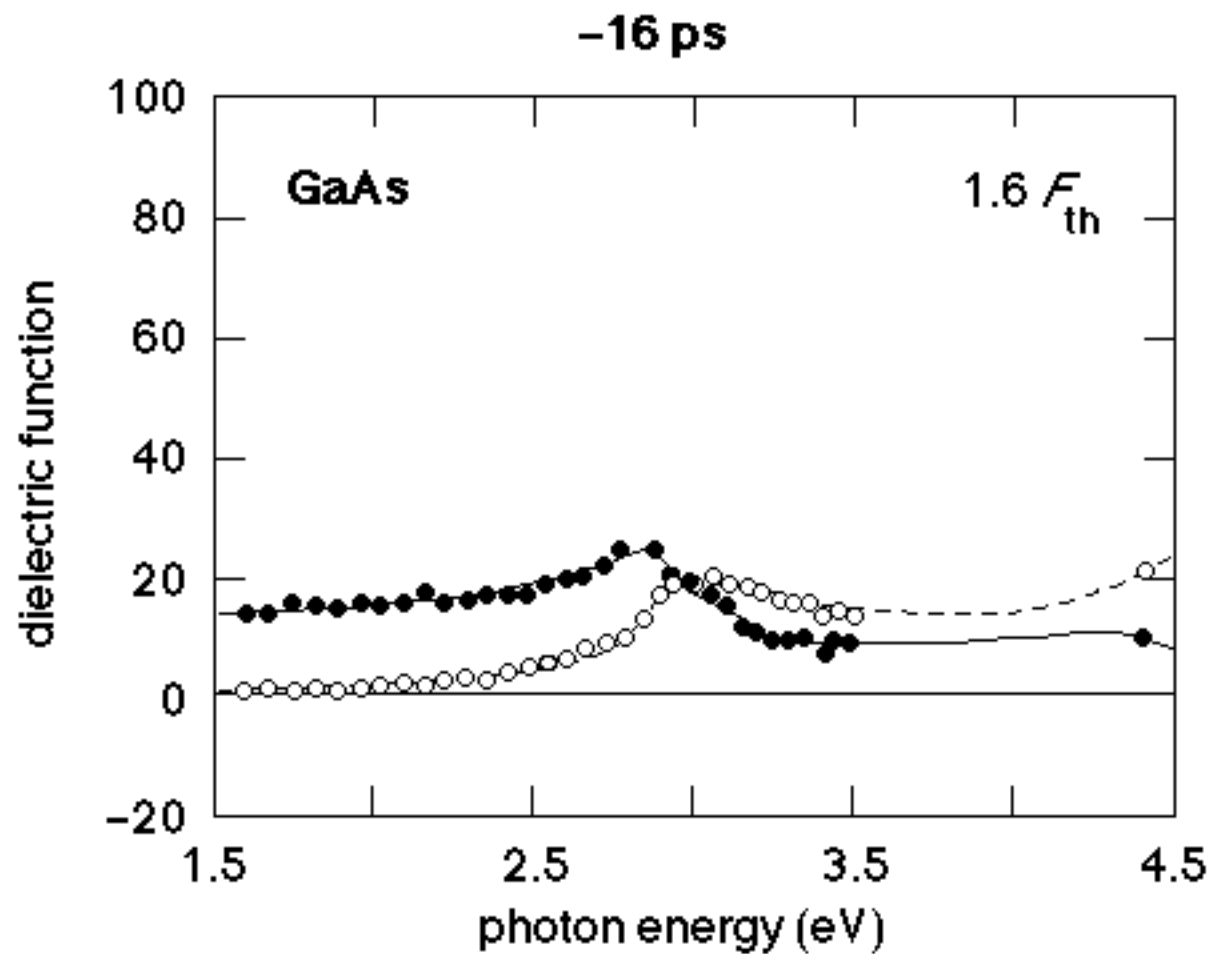

# BROADBAND DATA

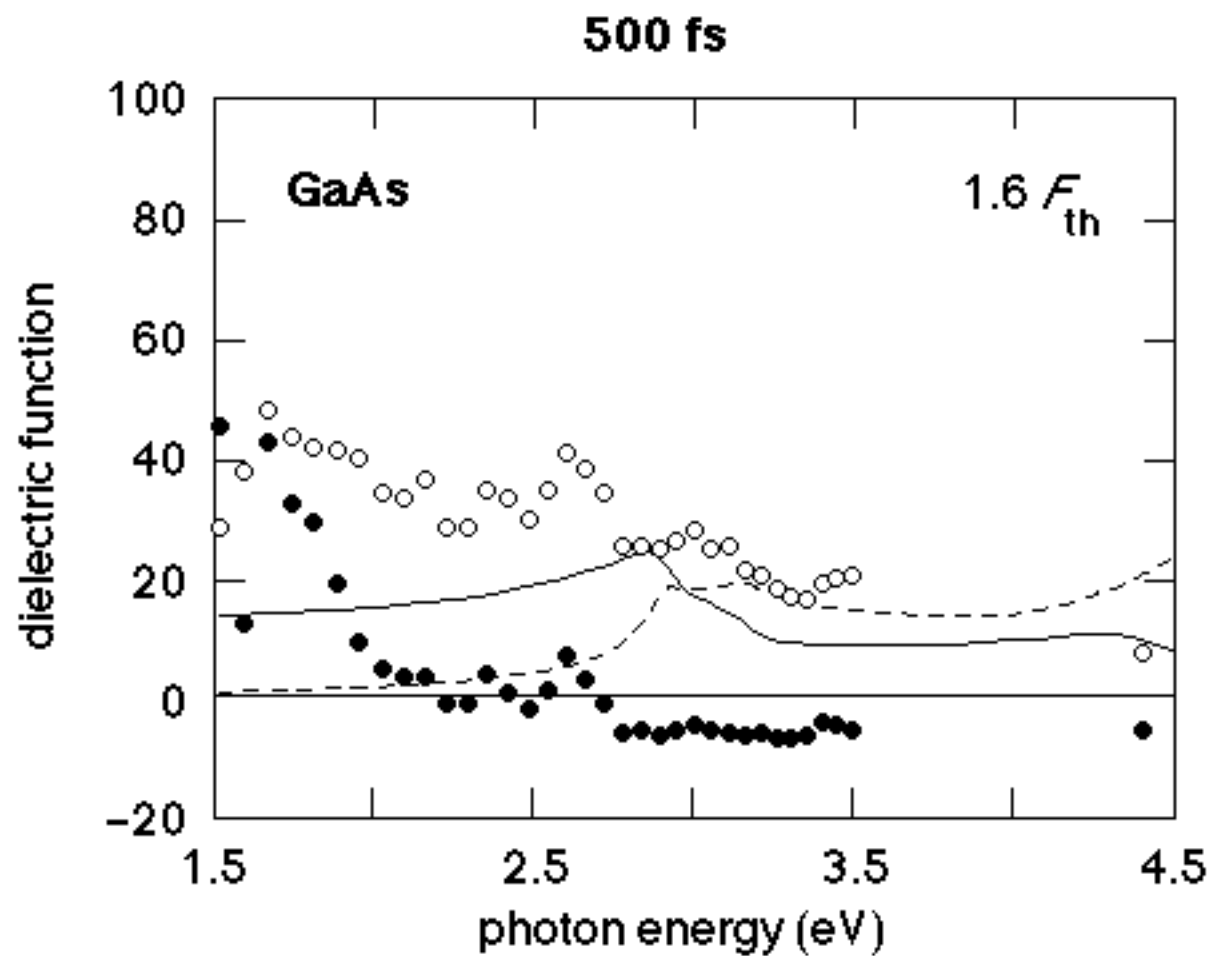

# BROADBAND DATA

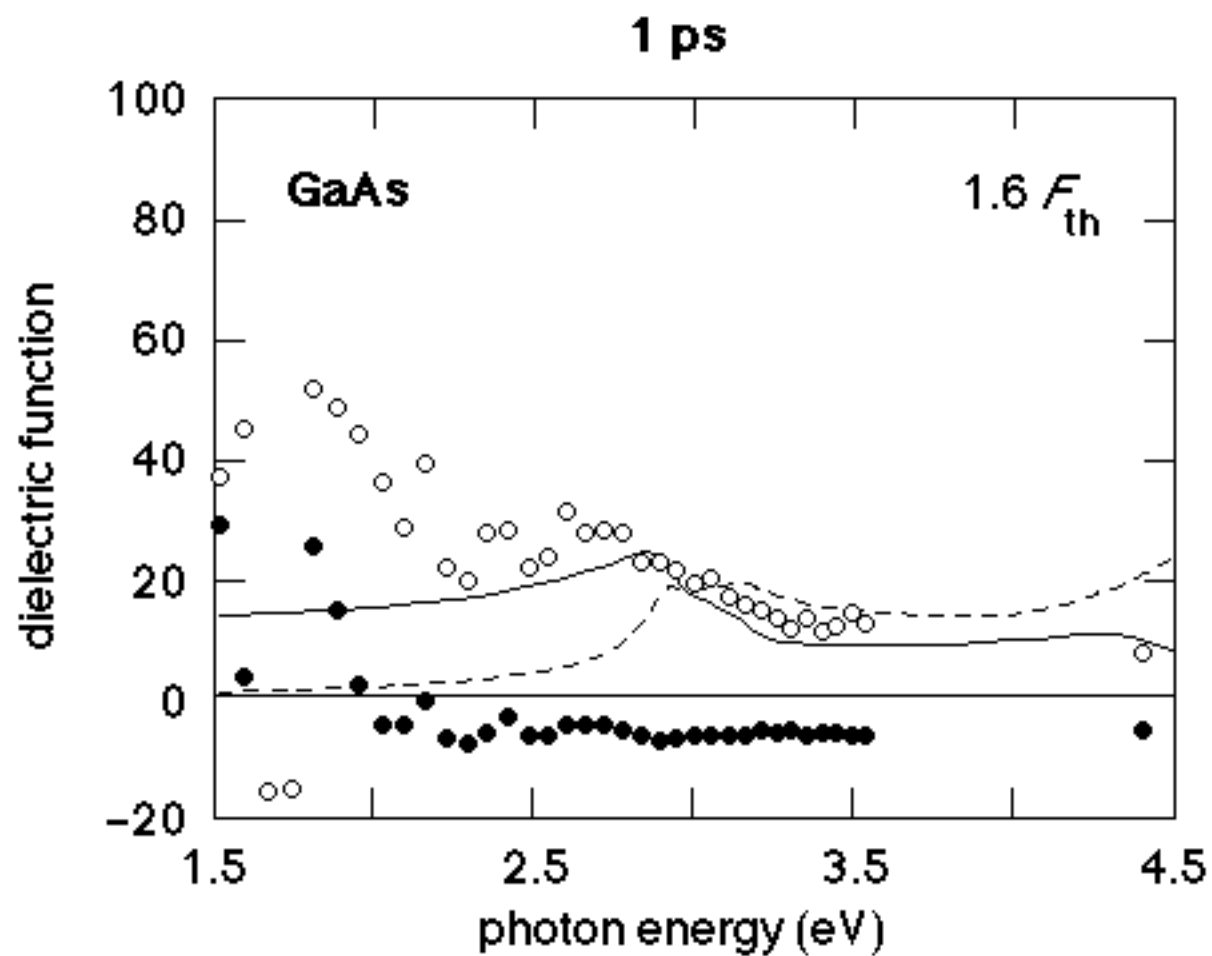



# BROADBAND DATA

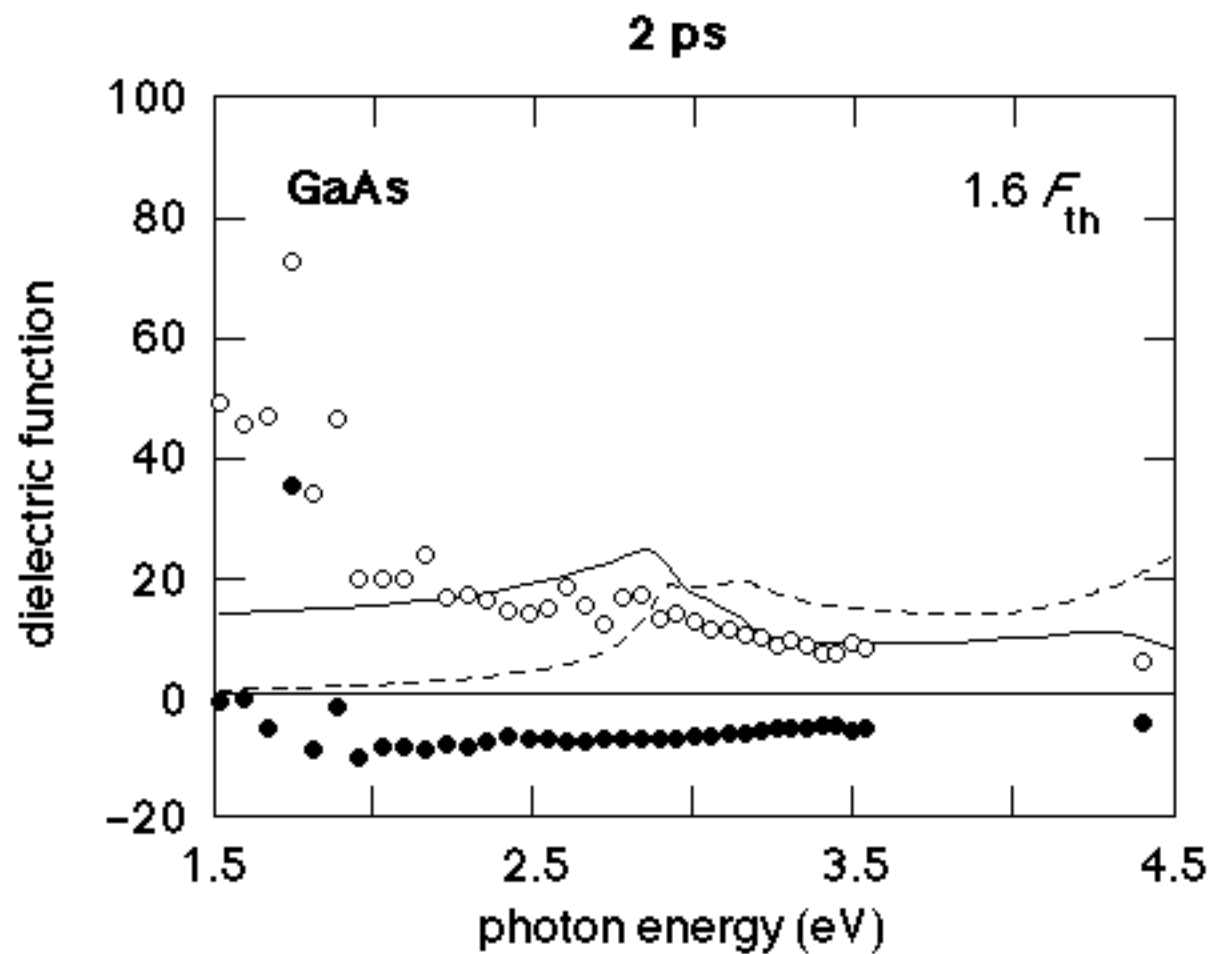

# BROADBAND DATA

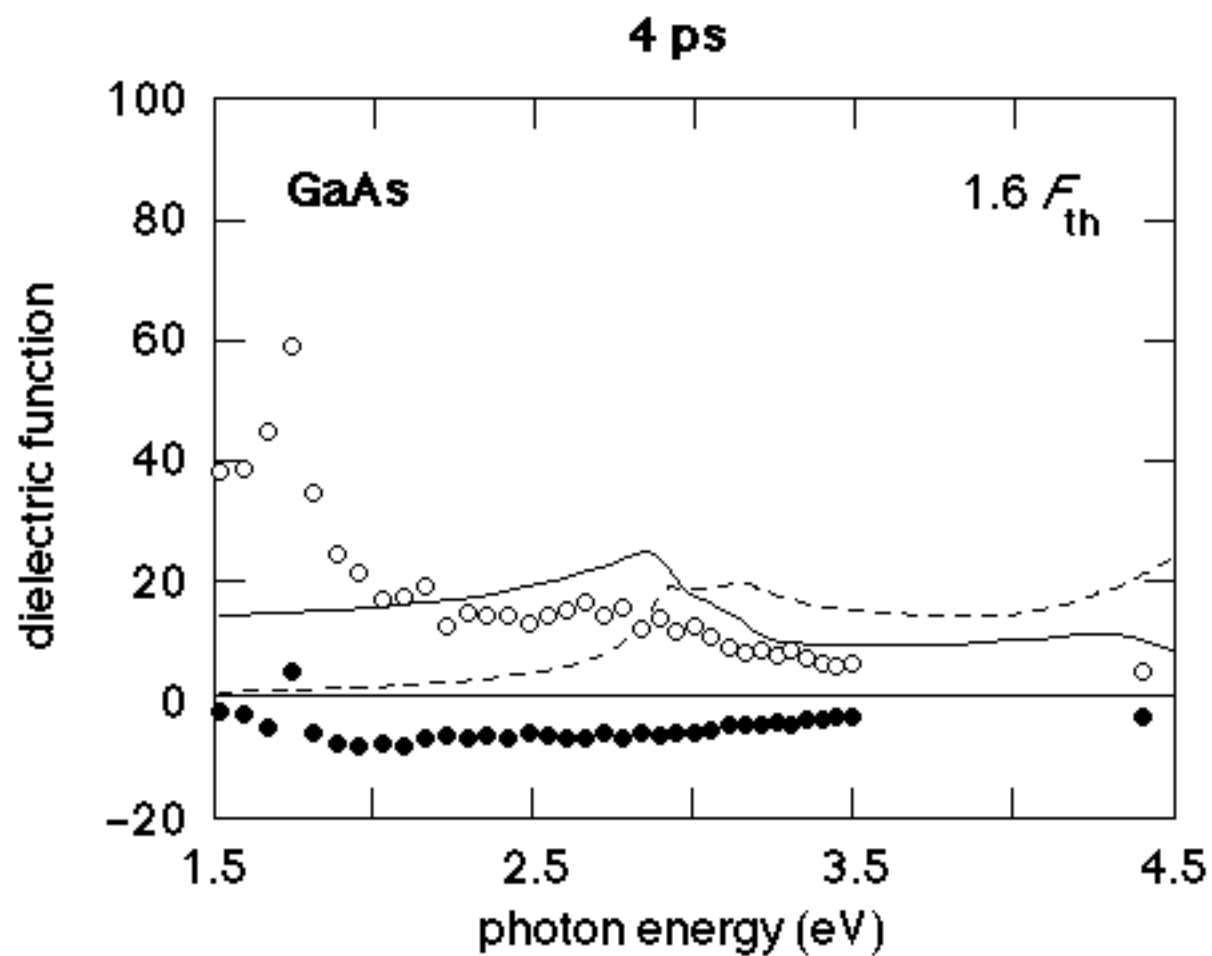

# BROADBAND DATA

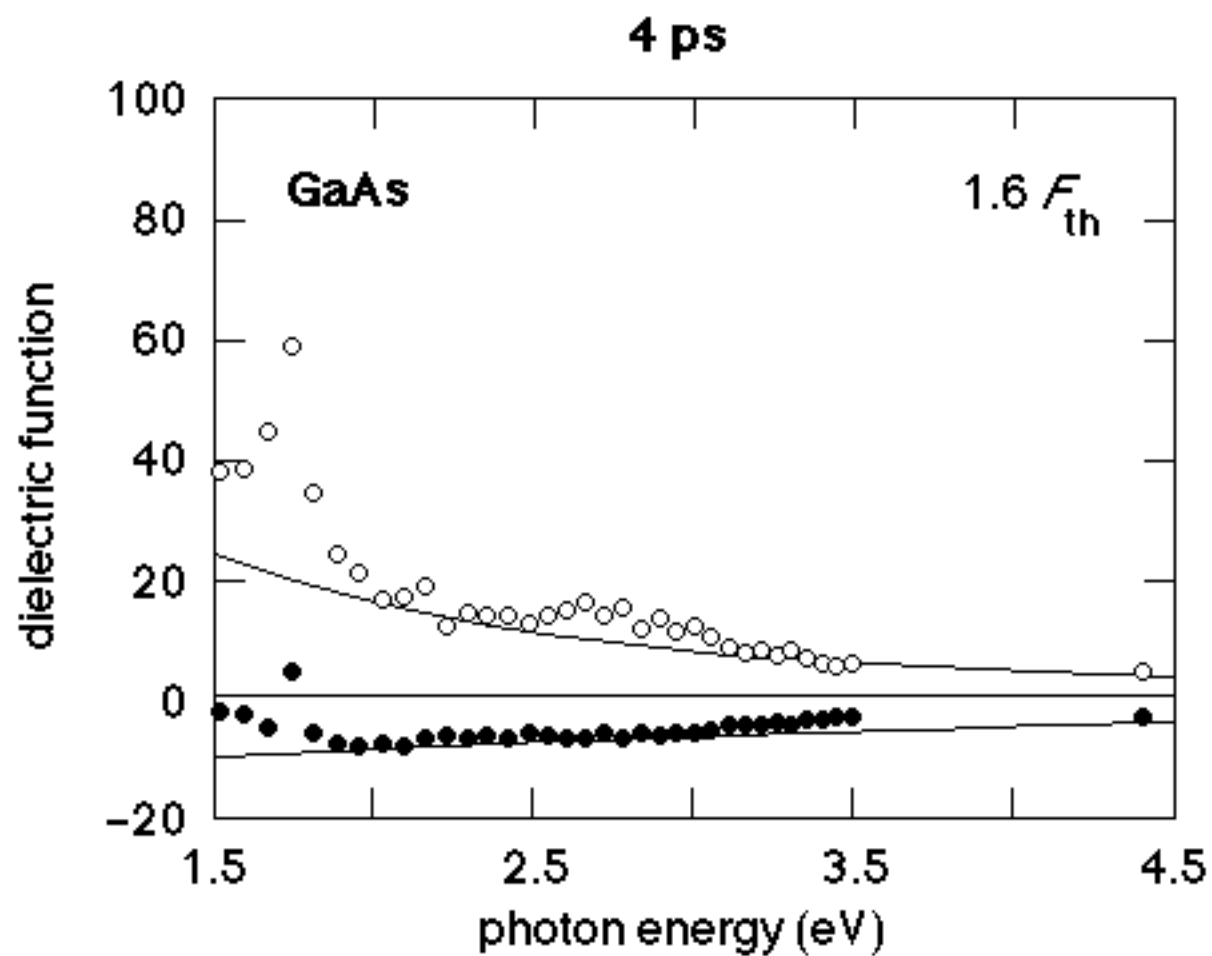

# ***BROADBAND DATA***

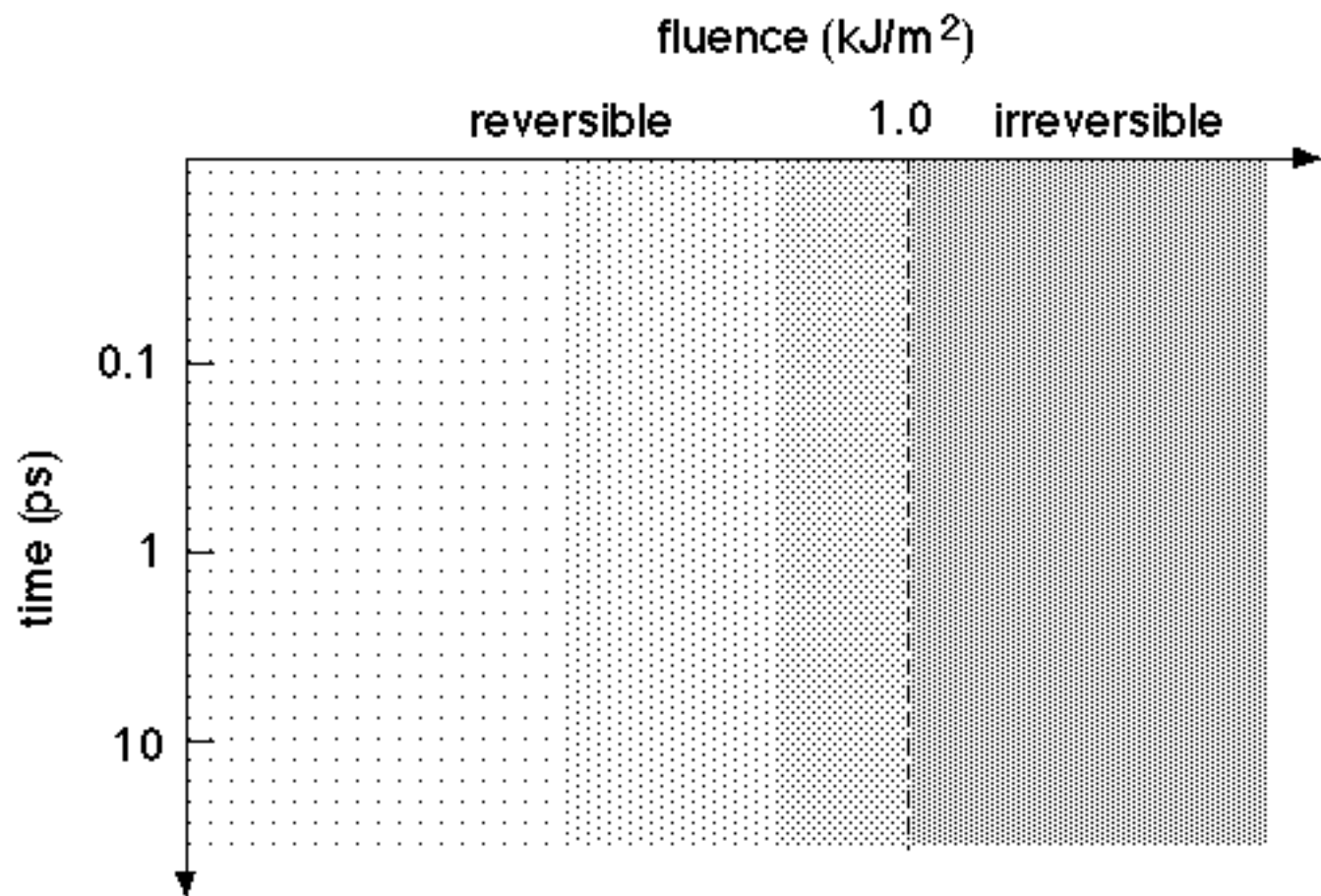

# ***BROADBAND DATA***

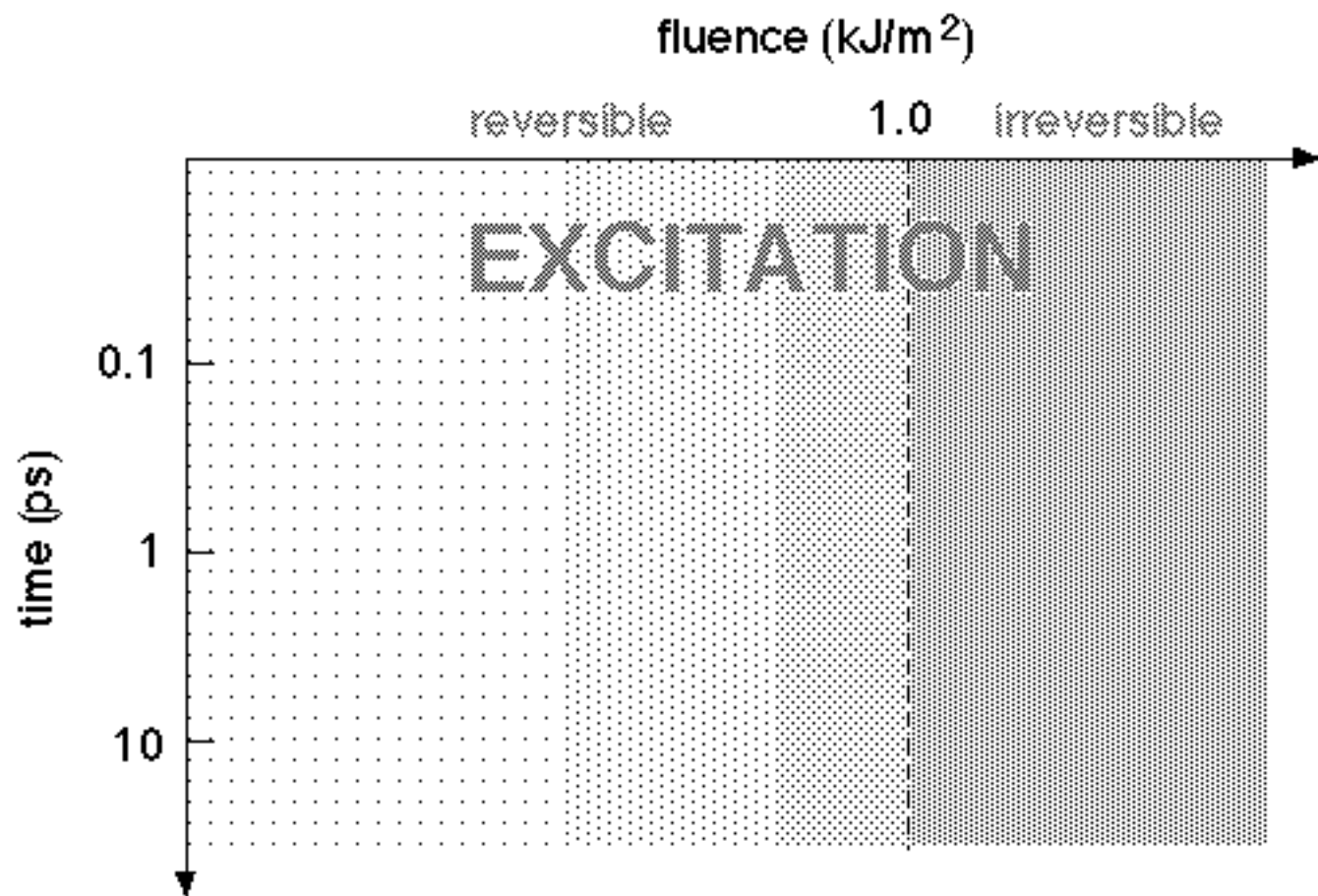

# ***BROADBAND DATA***

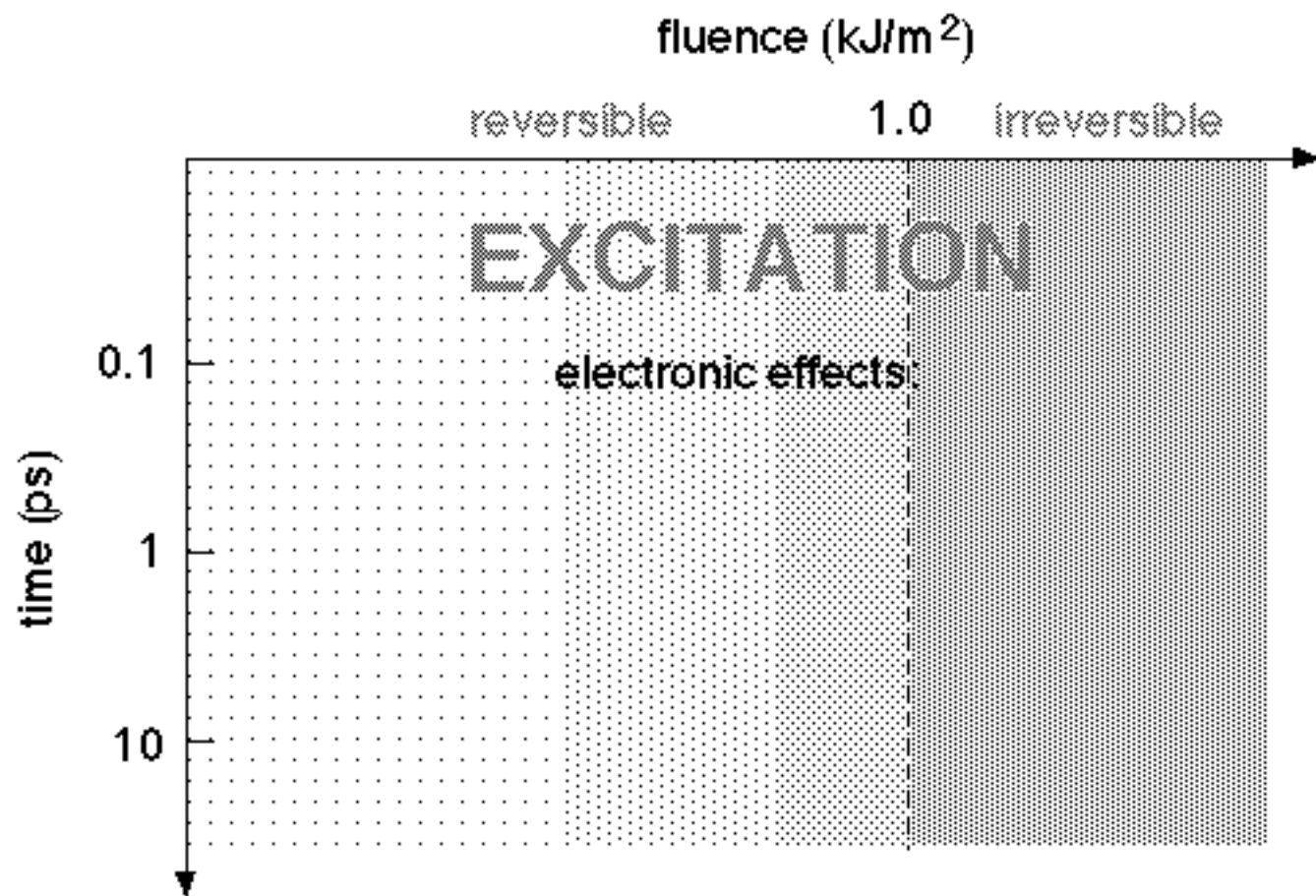

# BROADBAND DATA

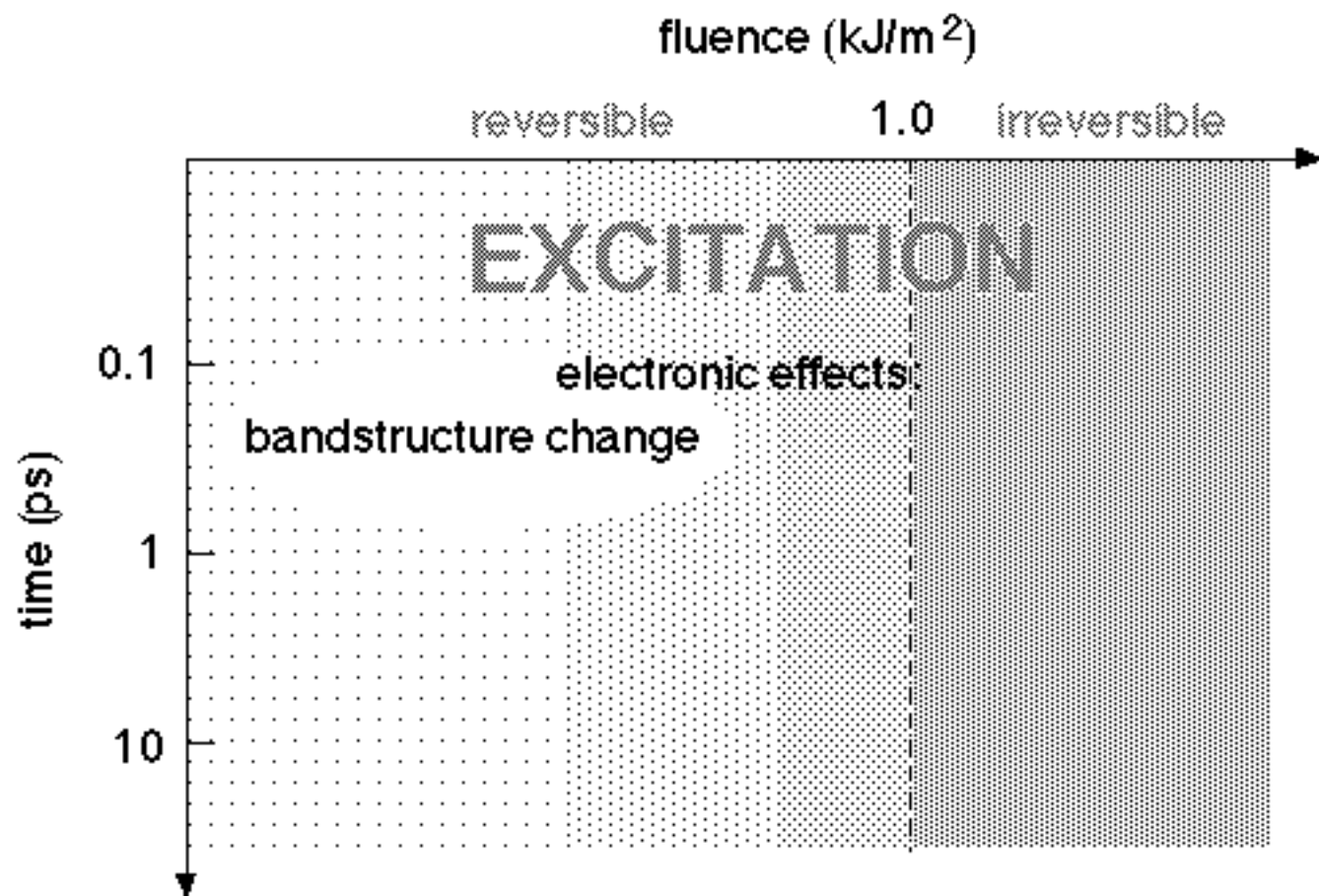

# ***BROADBAND DATA***

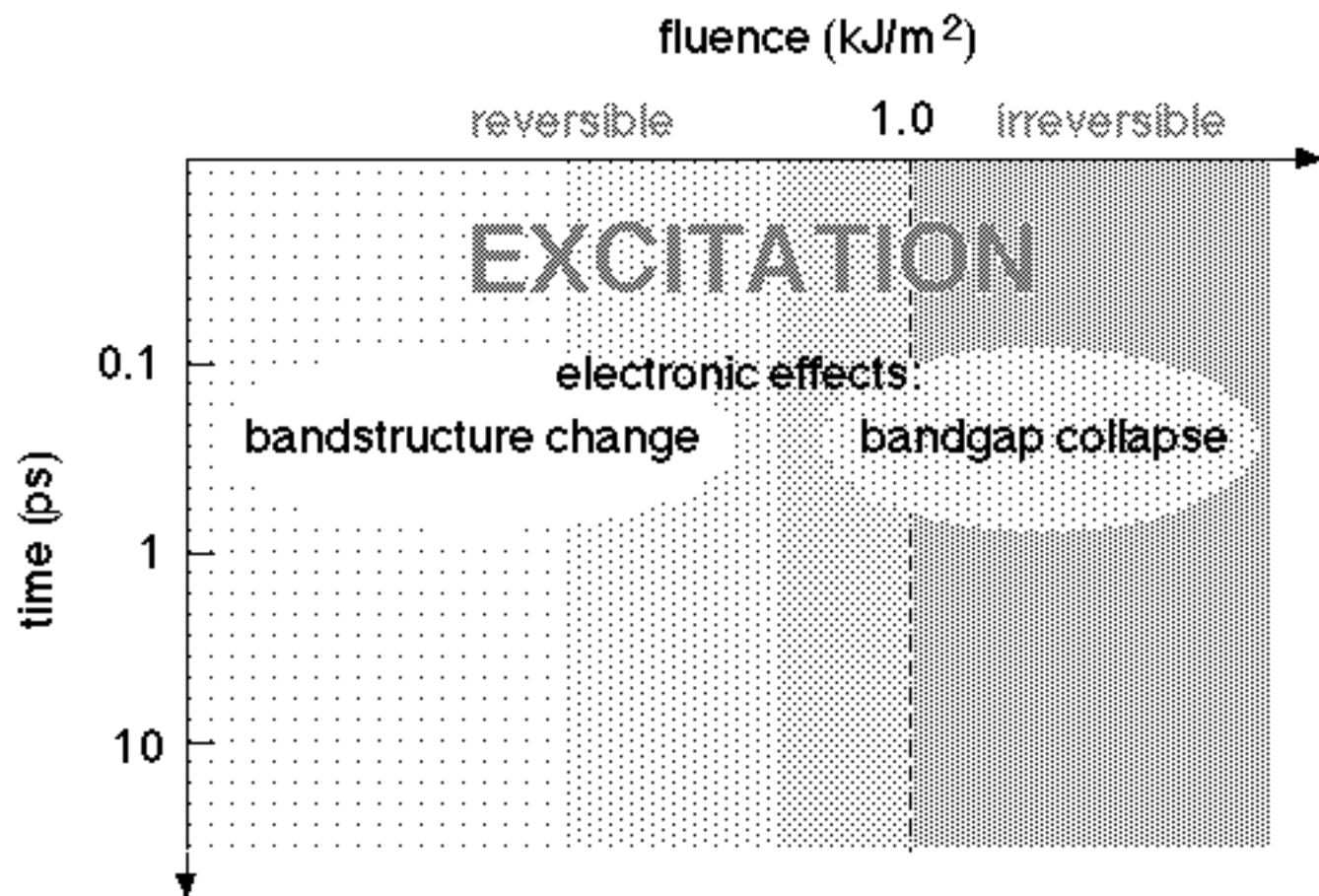



# BROADBAND DATA

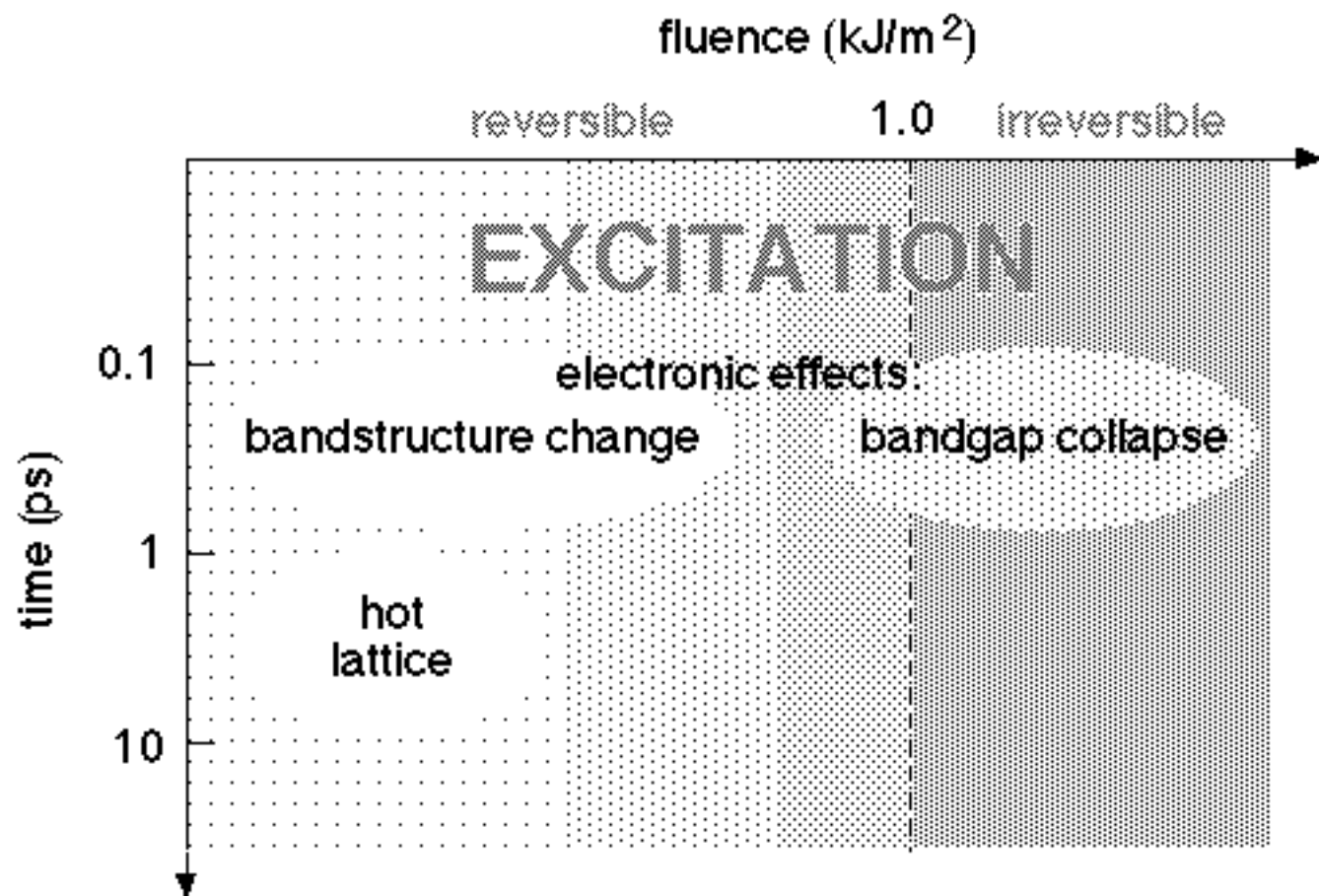

# BROADBAND DATA

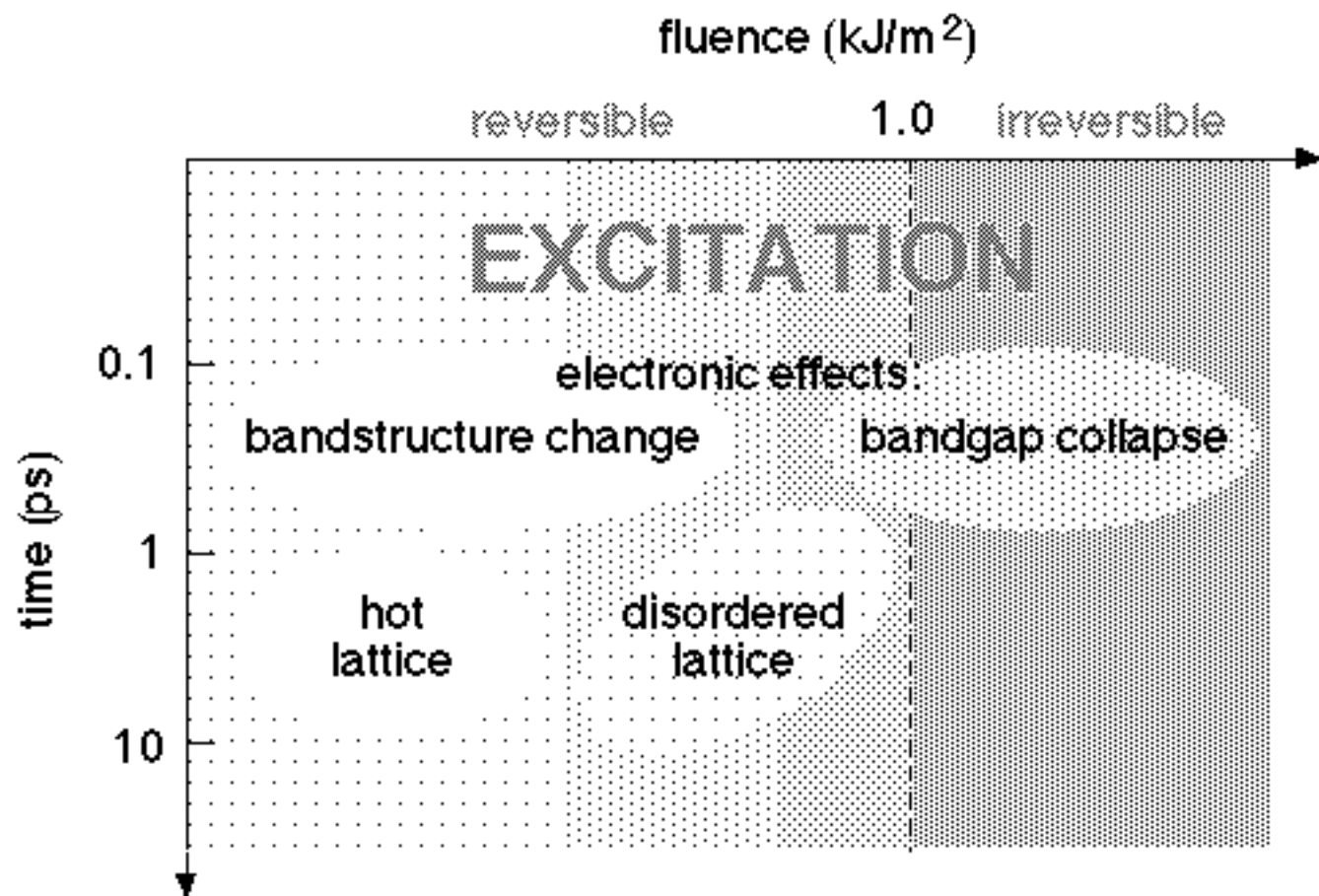

# BROADBAND DATA

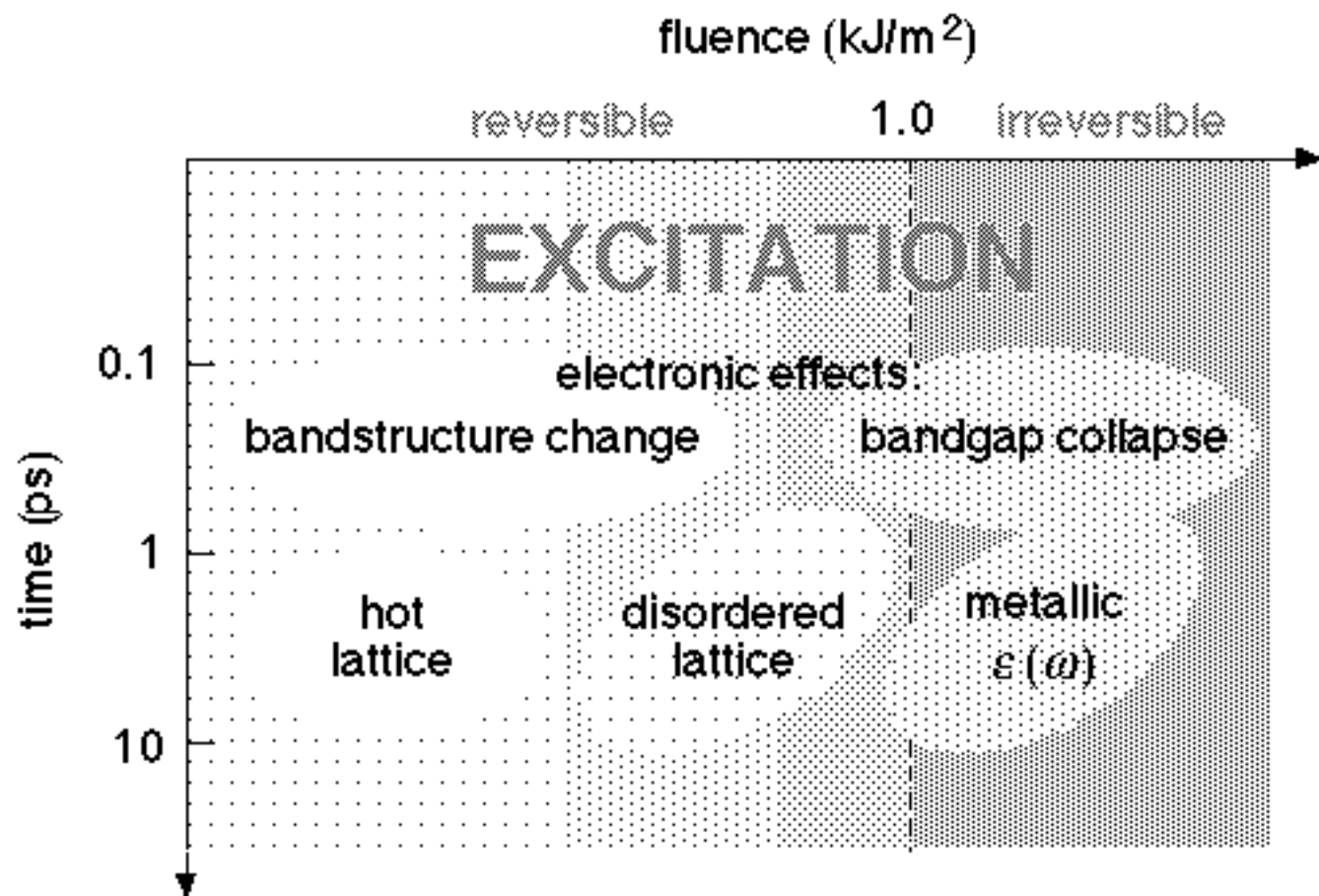

- ① Background
- ② Dielectric function
- ③ Nonlinear properties



## *CAUSE OF COLLAPSE*

What physical processes can change  $\epsilon(\omega)$ ?

- electronic effects: free carriers
- structural effects: atoms move

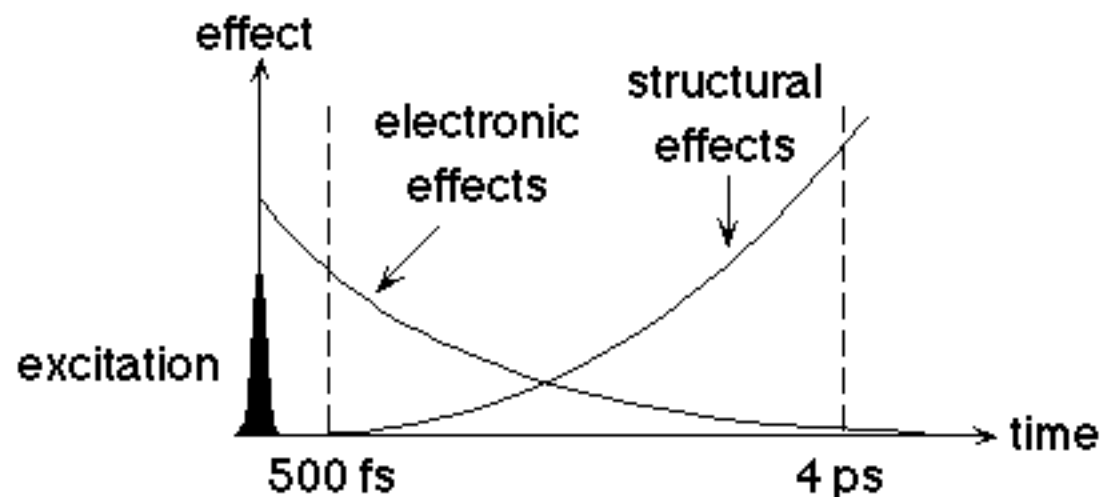

## *CAUSE OF COLLAPSE*

Electronic effects dominate at short times

- screening & many body effects
- direct free carrier effects (Drude model)

However,

changes in  $\epsilon(\omega)$  at short times do not fit a Drude model!



## *CAUSE OF COLLAPSE*

Is rapid structural change possible?

- excite 10% of valence electrons → lattice instability
- 10% change in bond length → semiconductor to metal transition

Time-scale for structural change reasonable:  
moving 10% of bond length in 1 ps requires 25 m/s



## ***NONLINEAR OPTICS***

Field strength at second harmonic:

$$E_r(2\omega) = -4\pi P^{(2)}(2\omega) g[\epsilon(\omega), \epsilon(2\omega), \theta_i]$$





## ***NONLINEAR OPTICS***

Field strength at second harmonic:

$$E_r(2\omega) = -4\pi P^{(2)}(2\omega) g[\epsilon(\omega), \epsilon(2\omega), \theta_i]$$

where:

$$P^{(2)}(2\omega) = 2\chi^{(2)} E_i^2(\omega) f[\epsilon(\omega), \theta_i]$$

so:



## NONLINEAR OPTICS

Field strength at second harmonic:

$$E_r(2\omega) = -4\pi P^{(2)}(2\omega) g[\epsilon(\omega), \epsilon(2\omega), \theta_i]$$

where:

$$P^{(2)}(2\omega) = 2\chi^{(2)} E_i^2(\omega) f[\epsilon(\omega), \theta_i]$$

so:

$$|\chi^{(2)}|^2 = \frac{E_r^2(2\omega)}{E_i^2(\omega) G[\epsilon(\omega), \epsilon(2\omega), \theta_i]}$$



## SECOND HARMONIC DATA

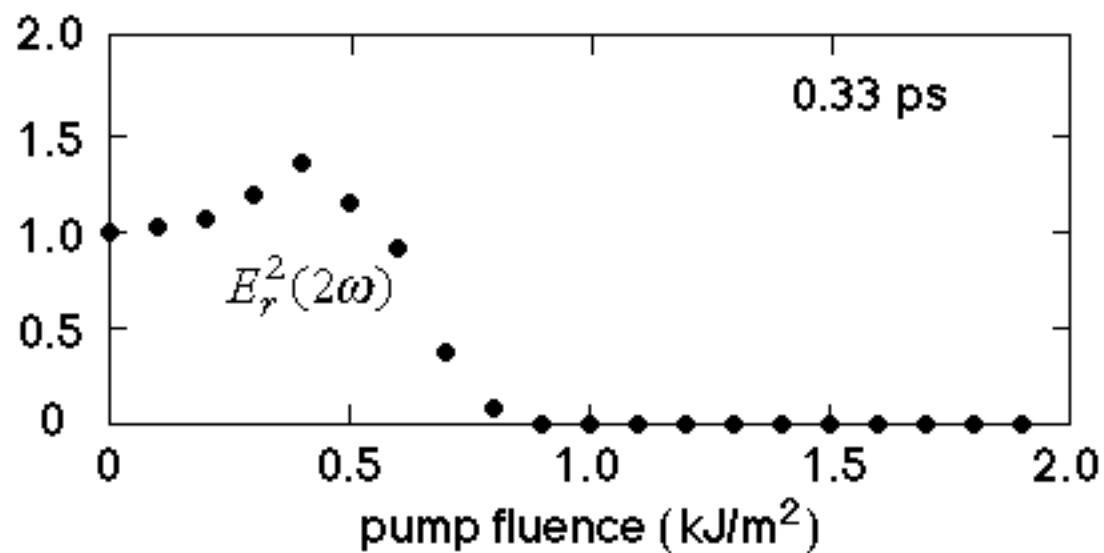

## SECOND HARMONIC DATA

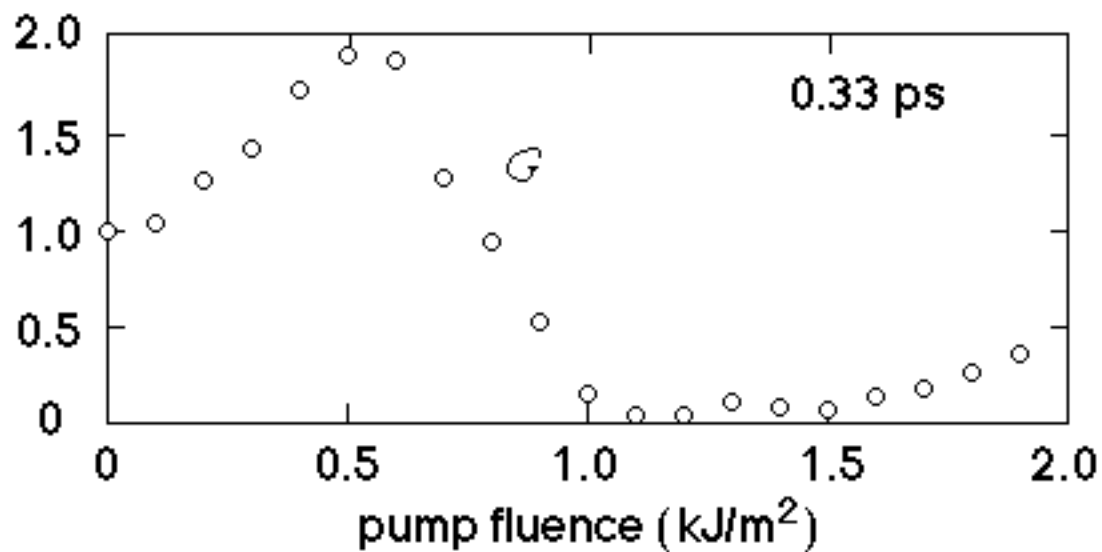

## SECOND HARMONIC DATA

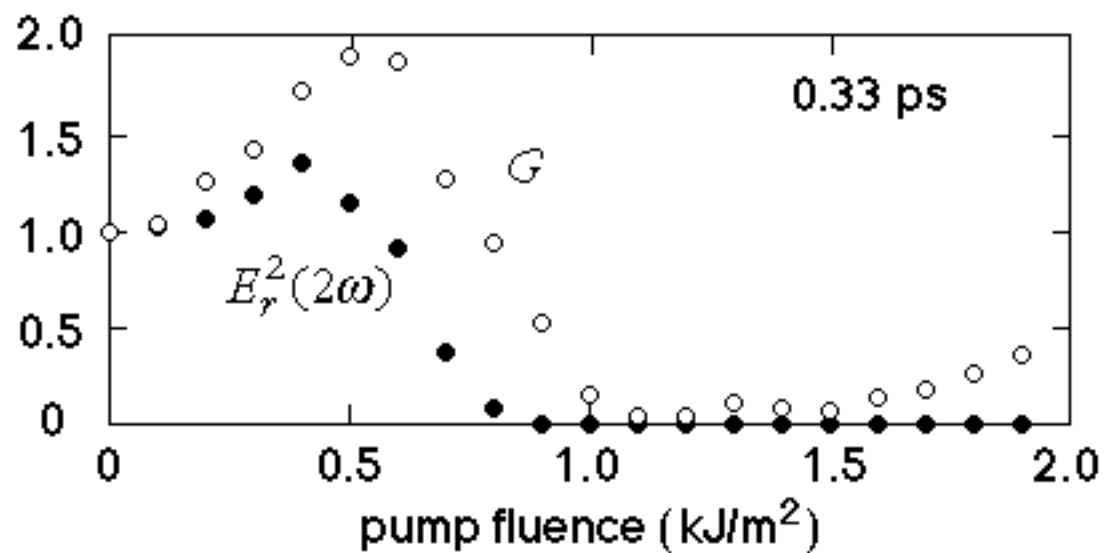

## SECOND HARMONIC DATA

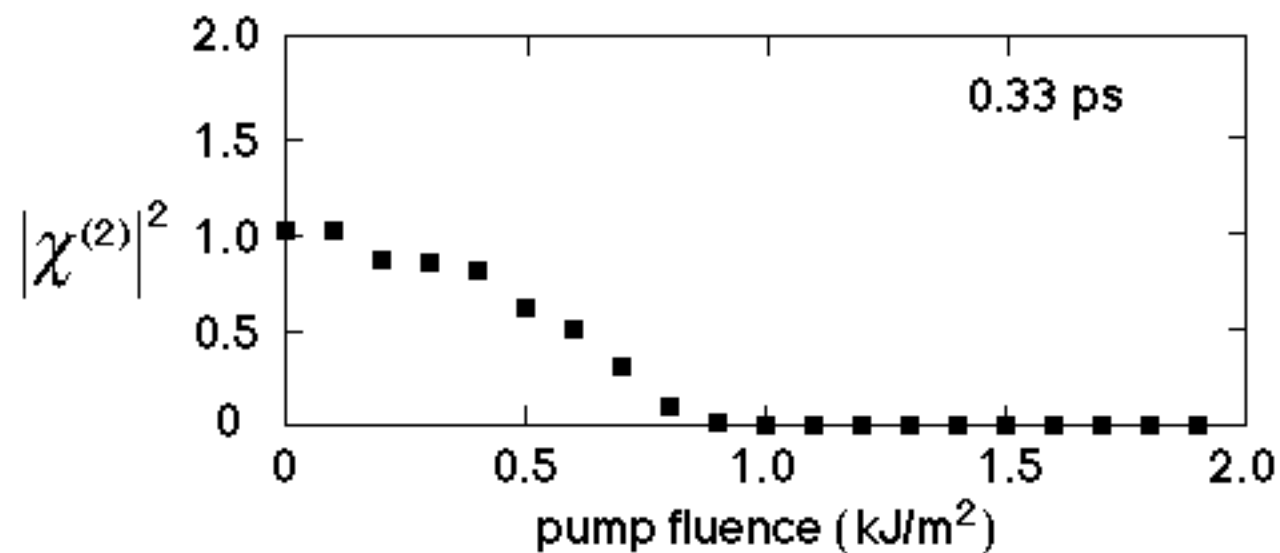

## SECOND HARMONIC DATA

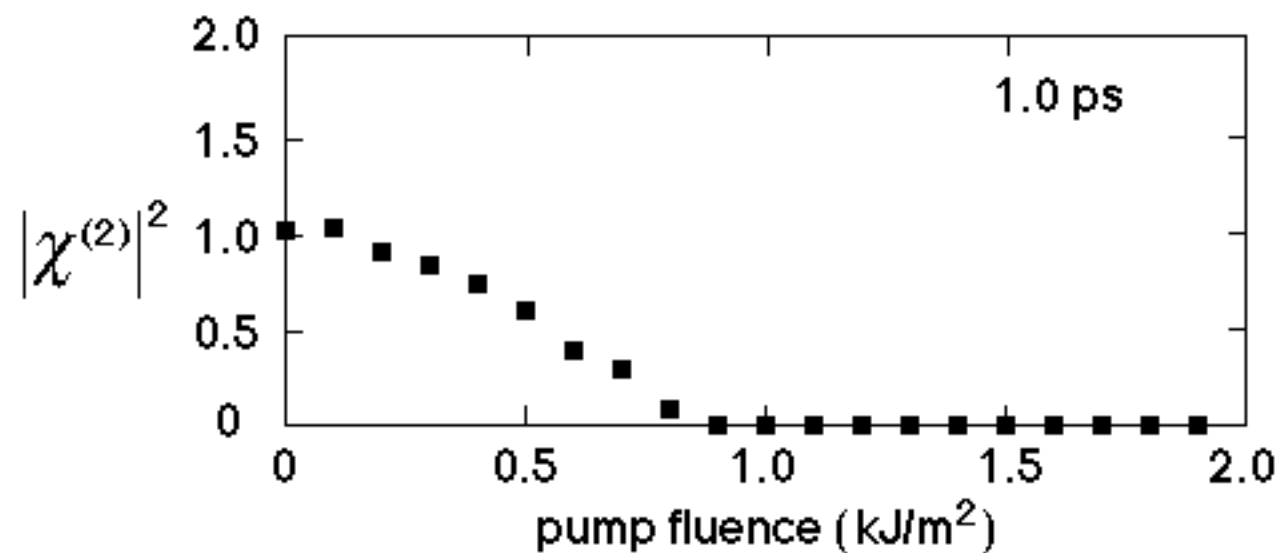

## SECOND HARMONIC DATA

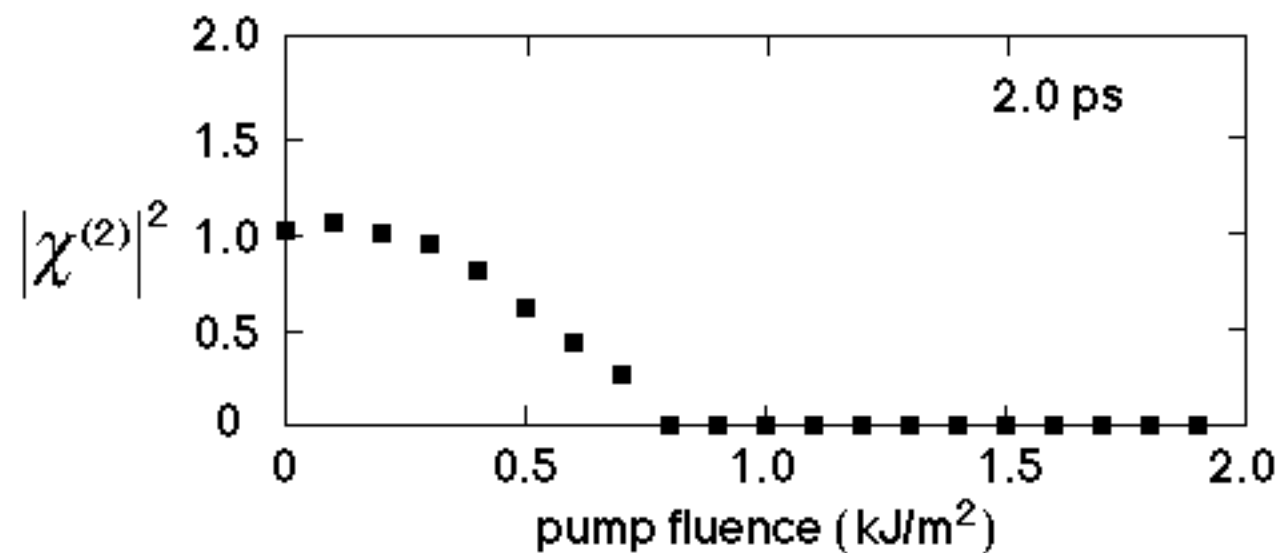



## SECOND HARMONIC DATA

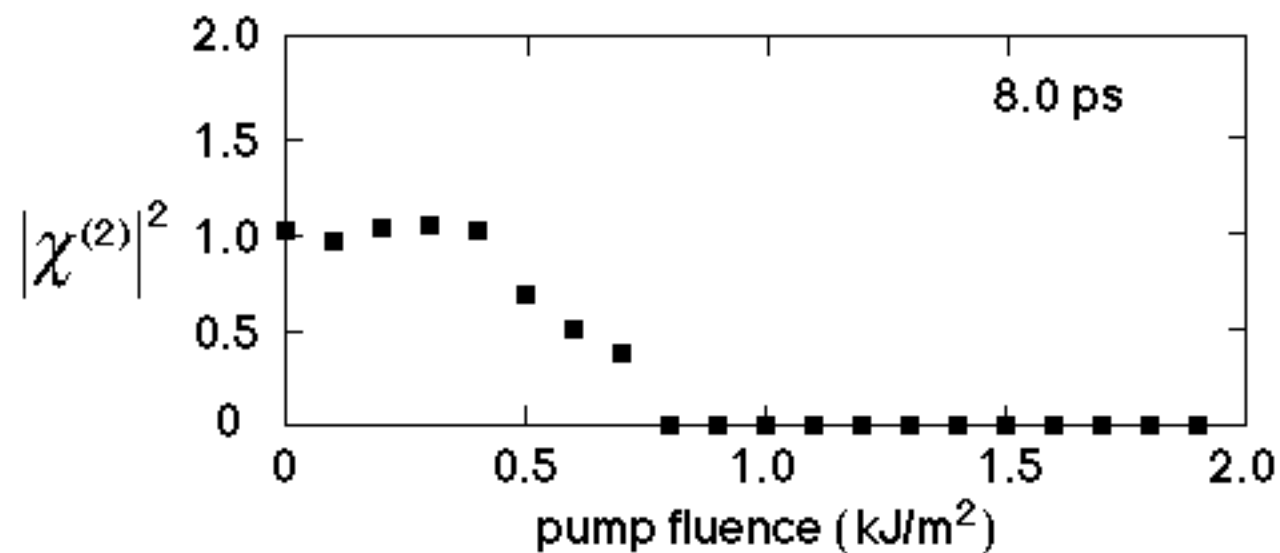

## SECOND HARMONIC DATA

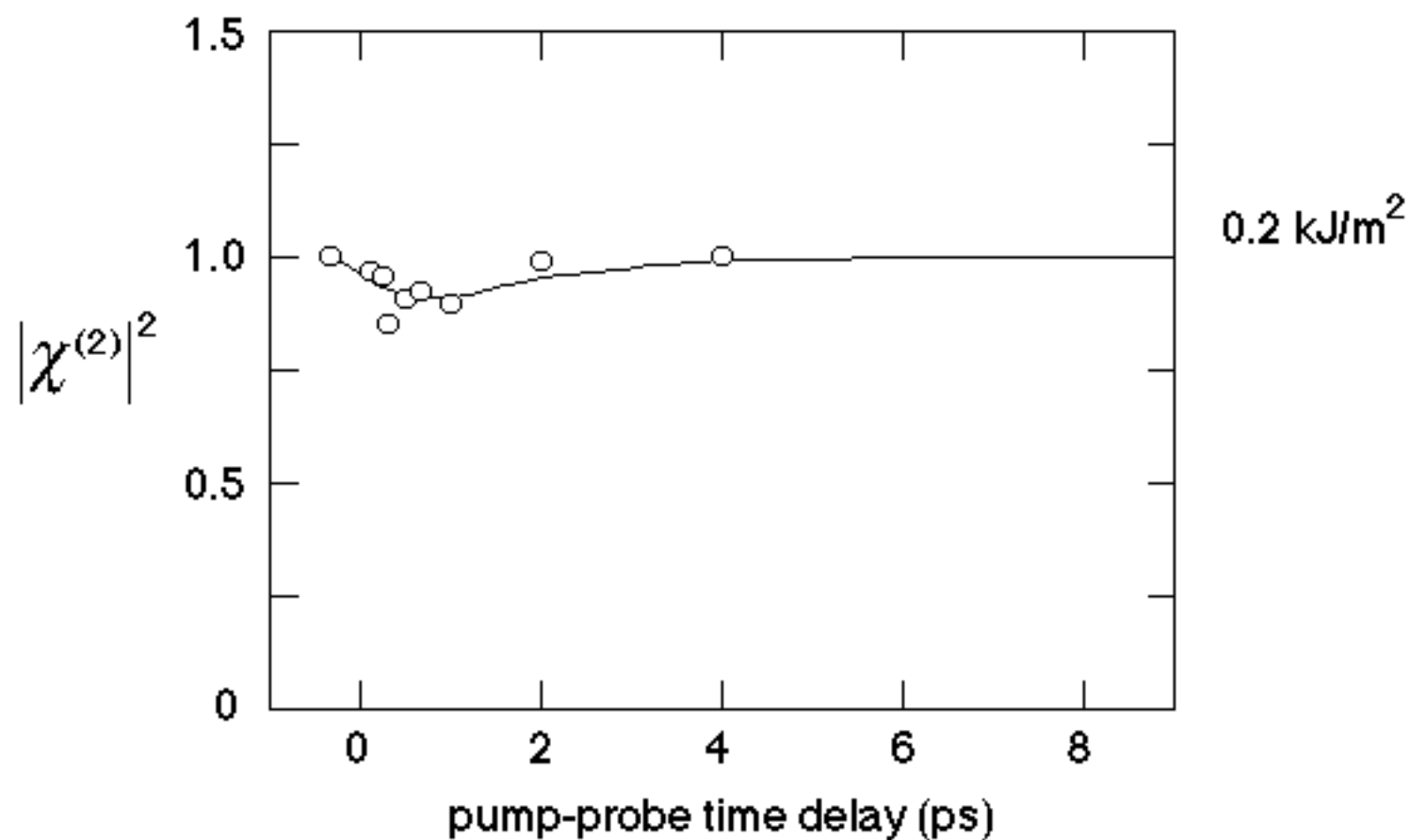

# SECOND HARMONIC DATA

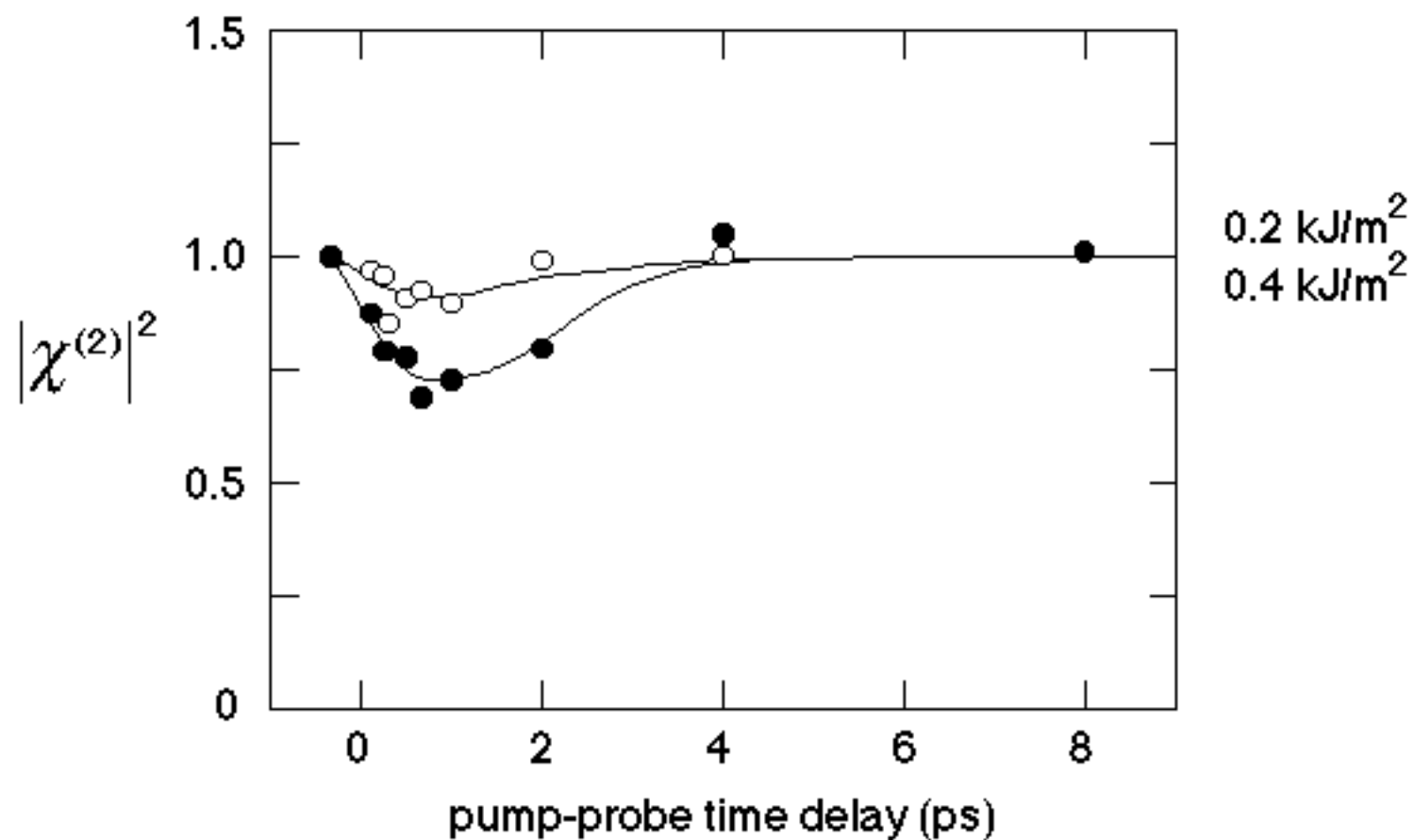

# SECOND HARMONIC DATA

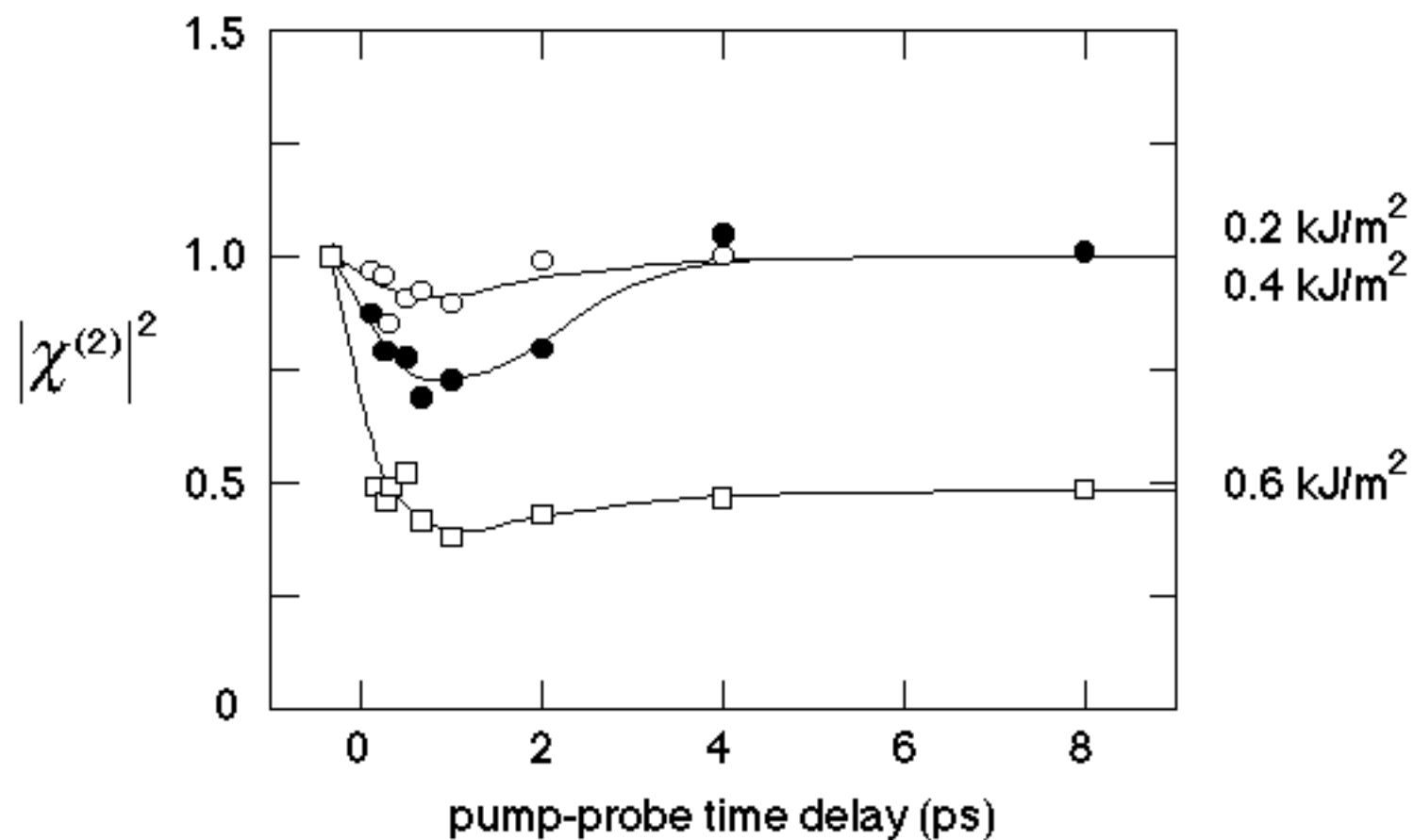

# SECOND HARMONIC DATA

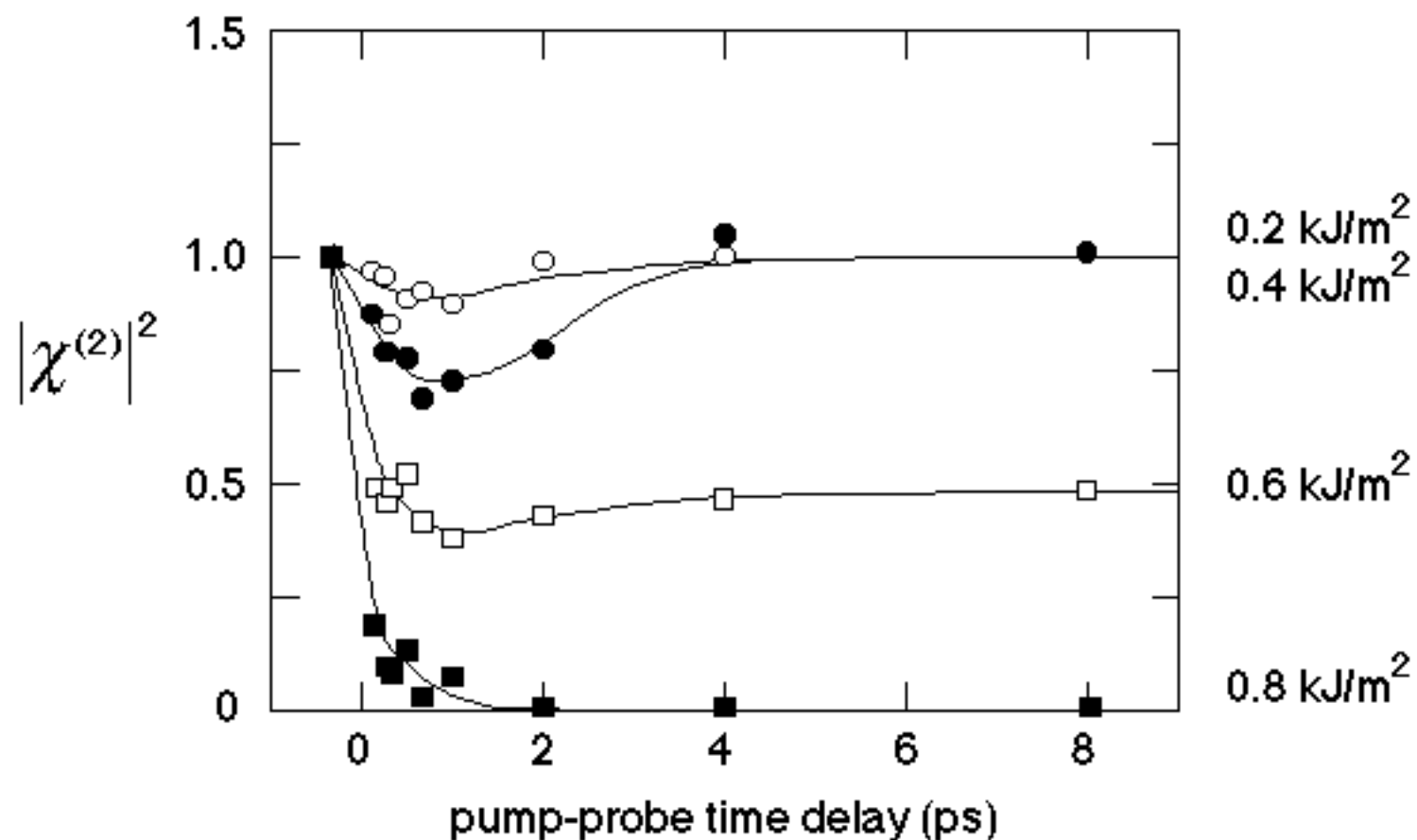

# SECOND HARMONIC DATA

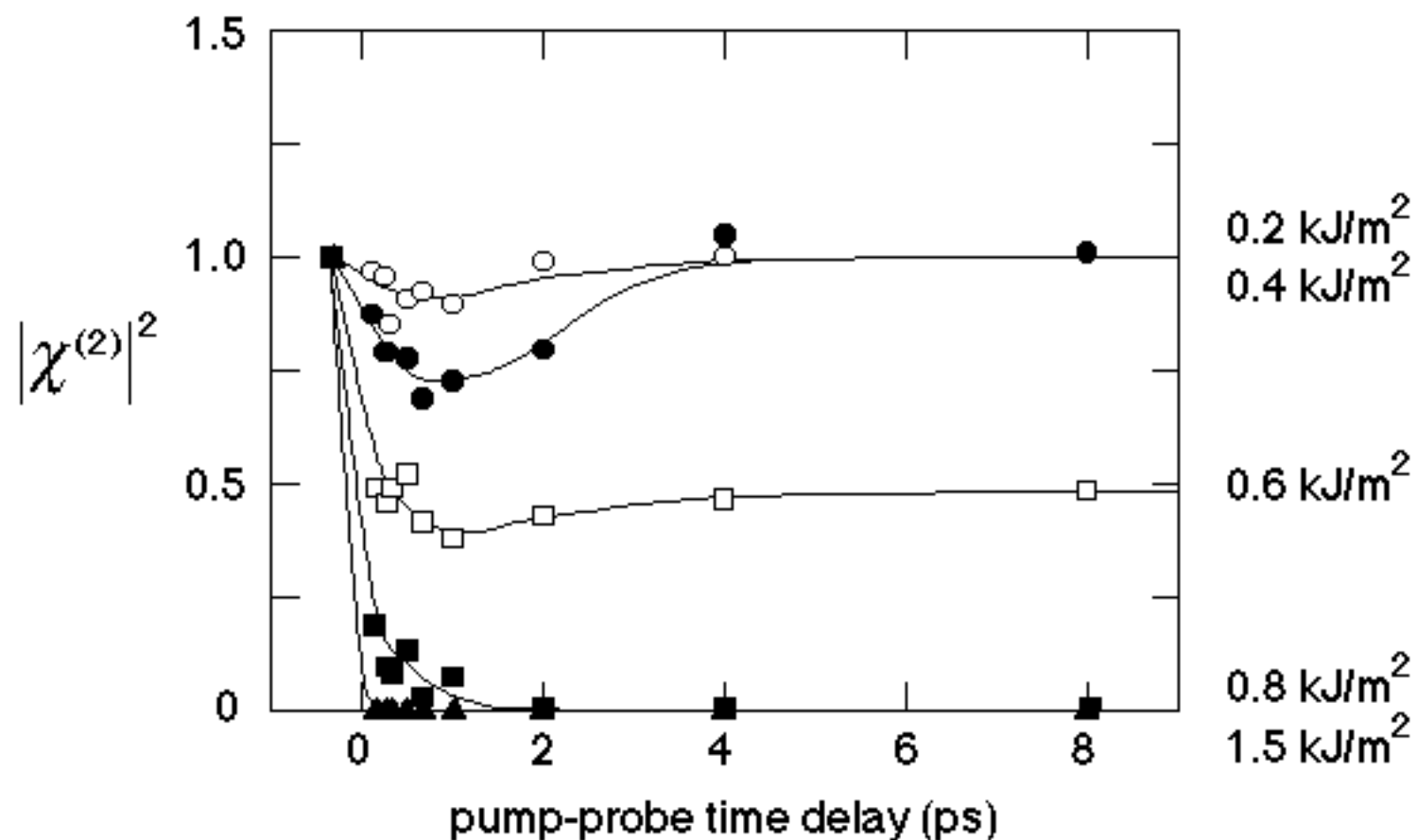

# EFFECT OF CHANGES IN $\epsilon$

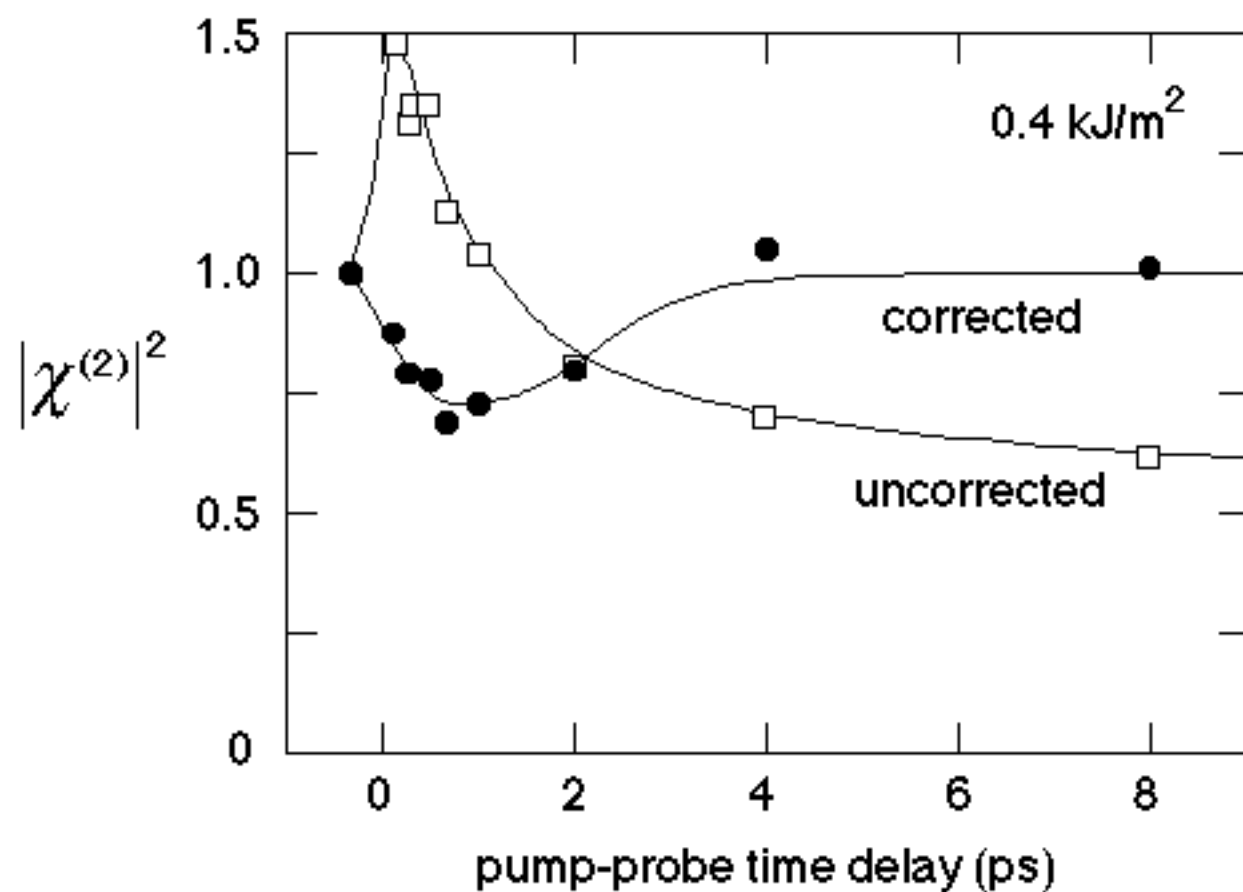

## *NONLINEAR WORK*

- $\chi^{(2)}$  sensitive to loss of long-range order
- long-range order disappears even below threshold
- structural change due to destabilization of covalent bonds





- ① Background
- ② Dielectric function
- ③ Nonlinear properties



- ▶ strong electronic excitation can drive a structural transition
- ▶ femtosecond lasers allow us to see the dynamics of the transition
- ▶ interesting reversible regime



## SOME QUESTIONS

- ▶ how hot does the plasma inside the material get?
- ▶ is only long-range order lost, or also short-range order?
- ▶ how can we study the atomic-scale physics?



## Acknowledgments

Prof. Bloembergen  
Prof. Ehrenreich  
Prof. Kaxiras  
Prof. Aziz

ONR N00014-89-J1023  
NSF DMR 89-20490

<http://mazor-www.harvard.edu>

