



PHASE TRANSFORMATIONS INDUCED BY FEMTOSECOND LASER PULSES

Eric Mazur

Paul Callan

Albert Kim

Gordon Conference

Proctor Academy

7 June 1998

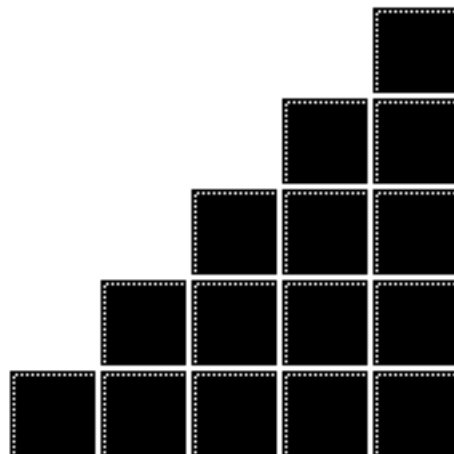

INTRODUCTION

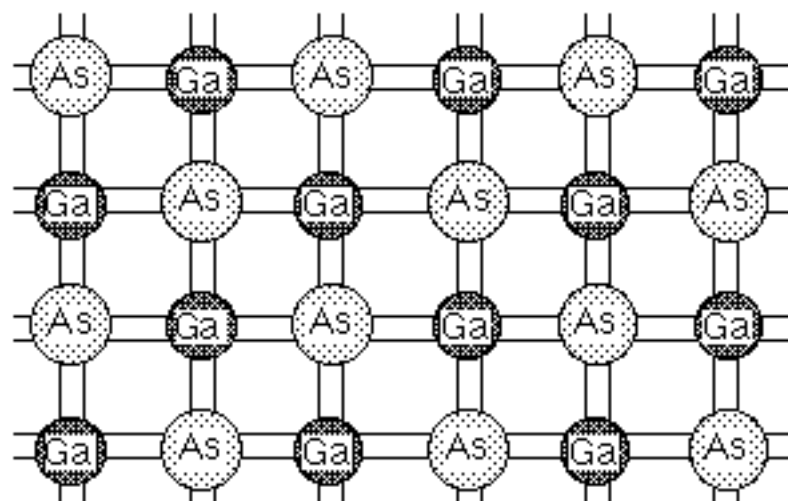

how do femtosecond pulses alter a solid?



INTRODUCTION

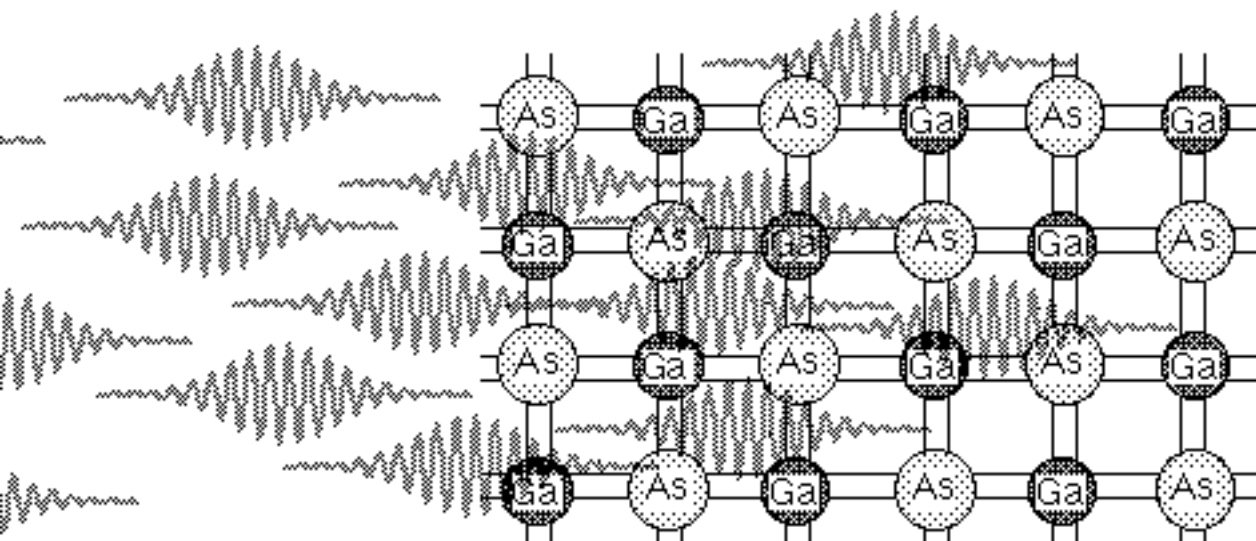

photons excite valence electrons...



INTRODUCTION

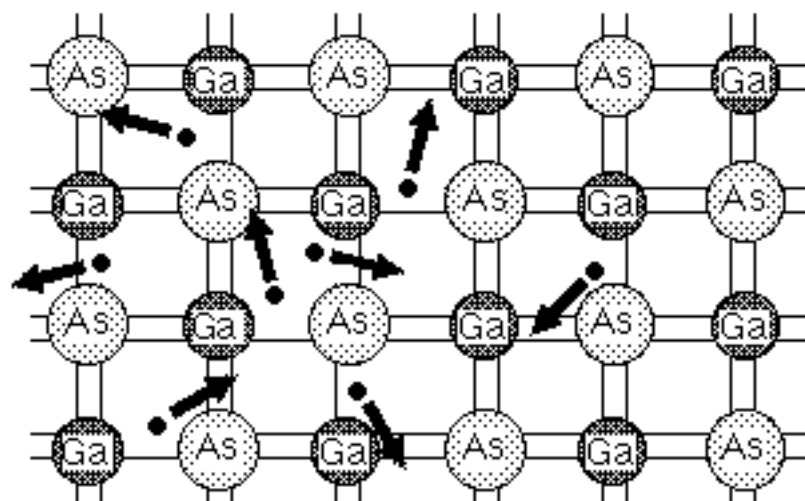

...and create free electrons...



INTRODUCTION

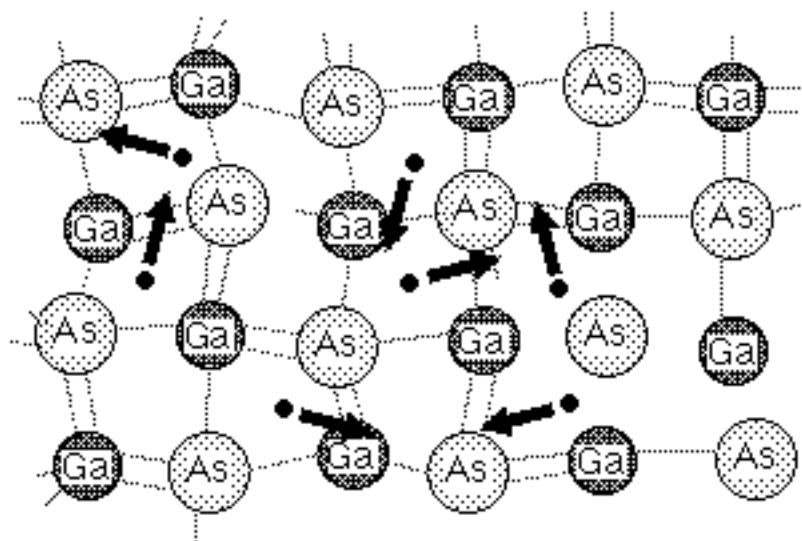

... causing electronic & structural changes...



INTRODUCTION

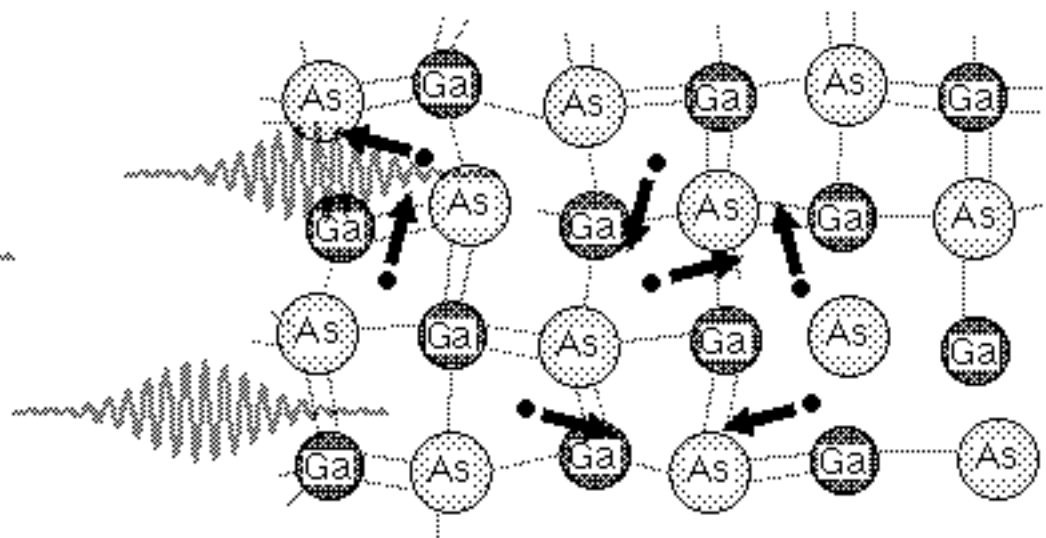

... which we measure with another pulse...



INTRODUCTION

single photon excitation

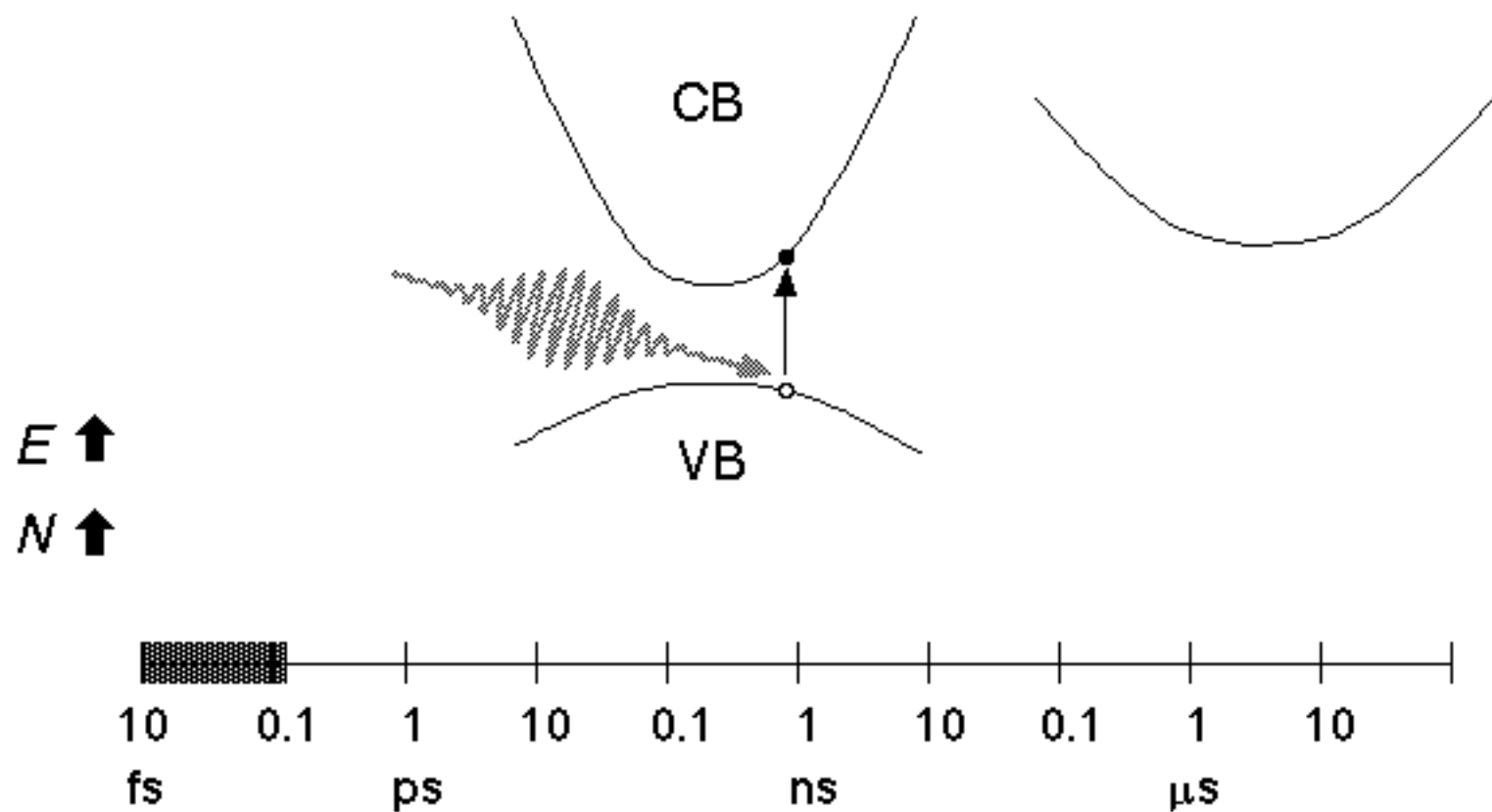

INTRODUCTION

multi photon excitation

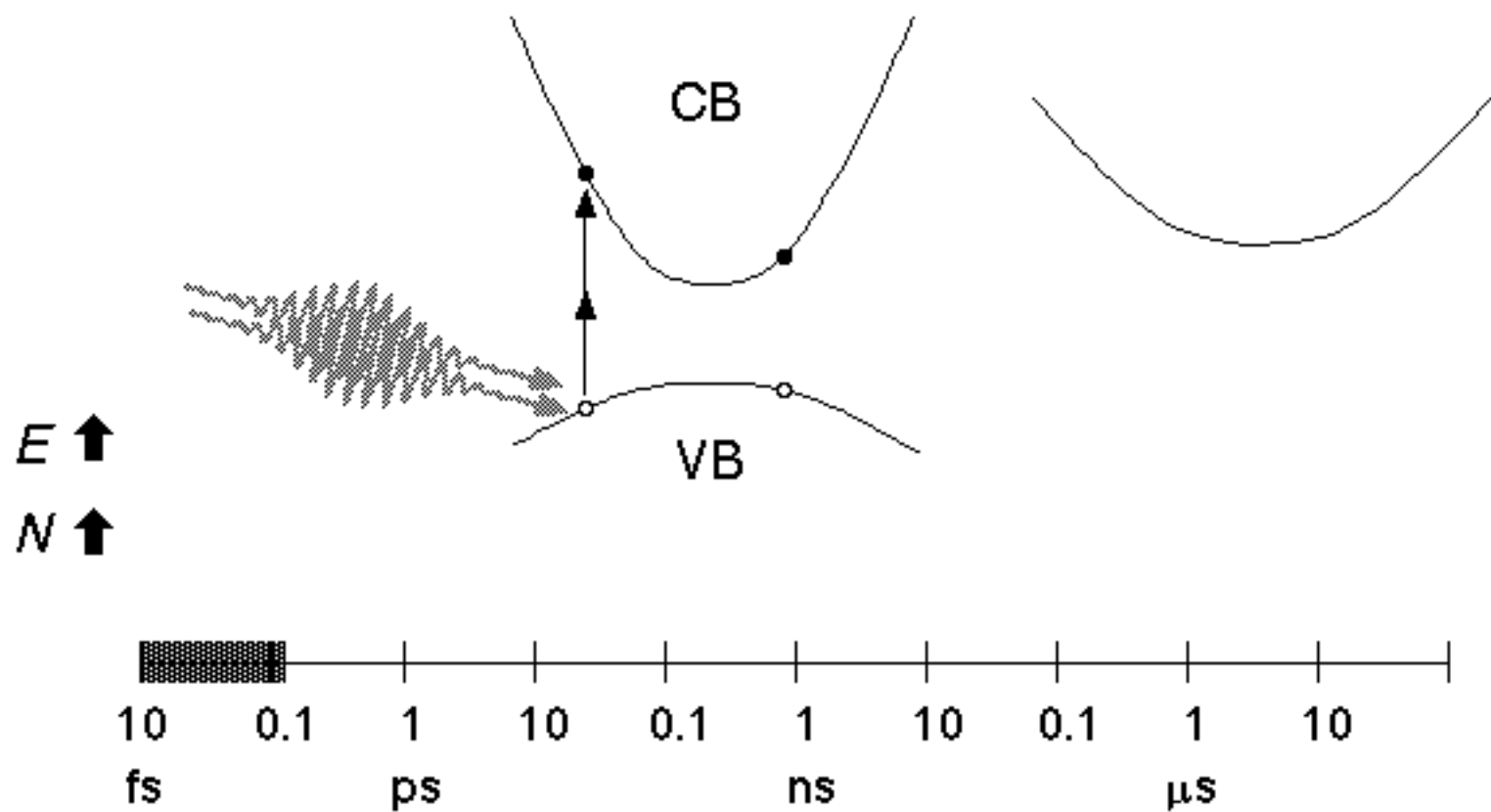

INTRODUCTION

free carrier absorption

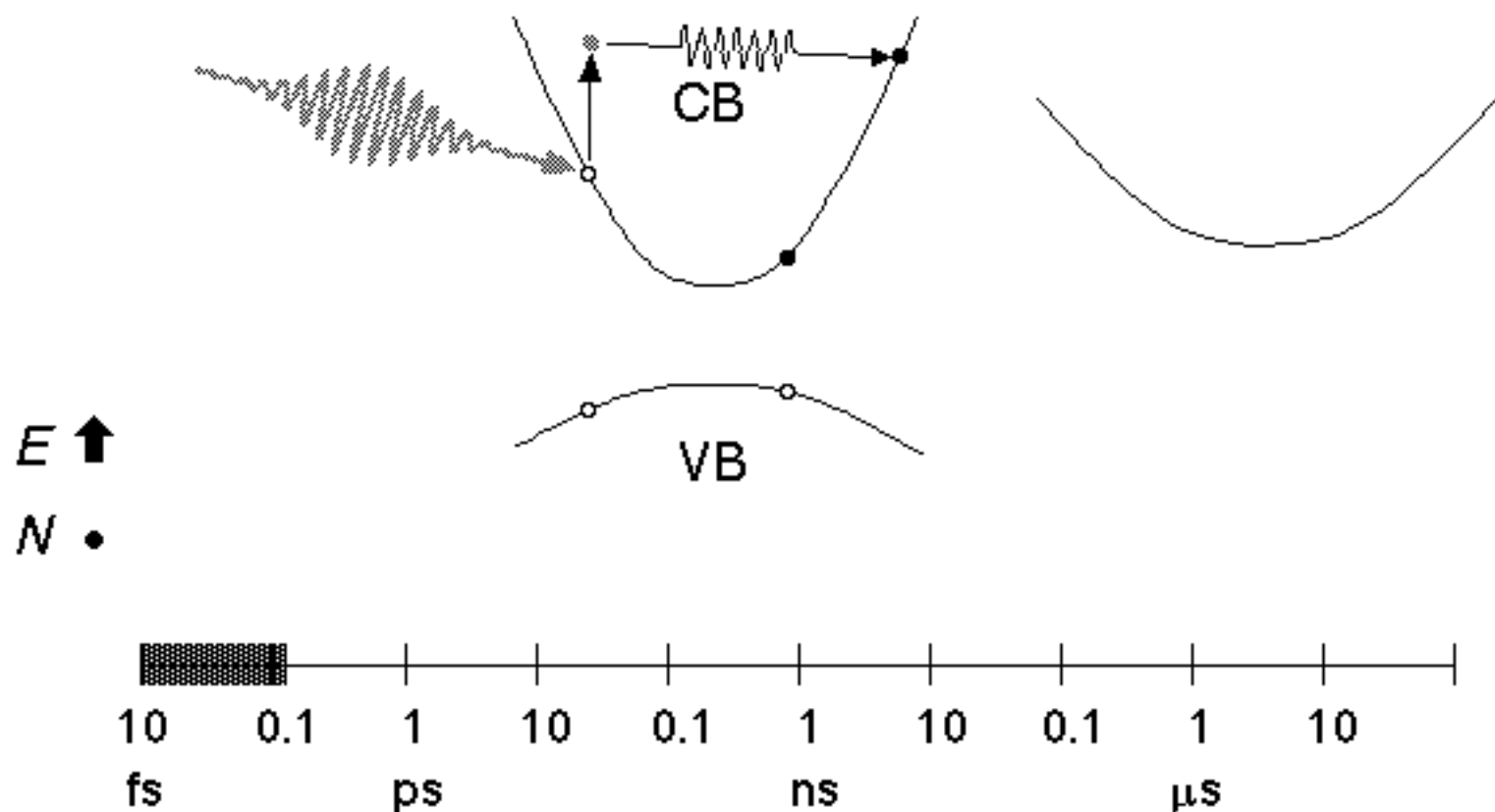

INTRODUCTION

impact ionization

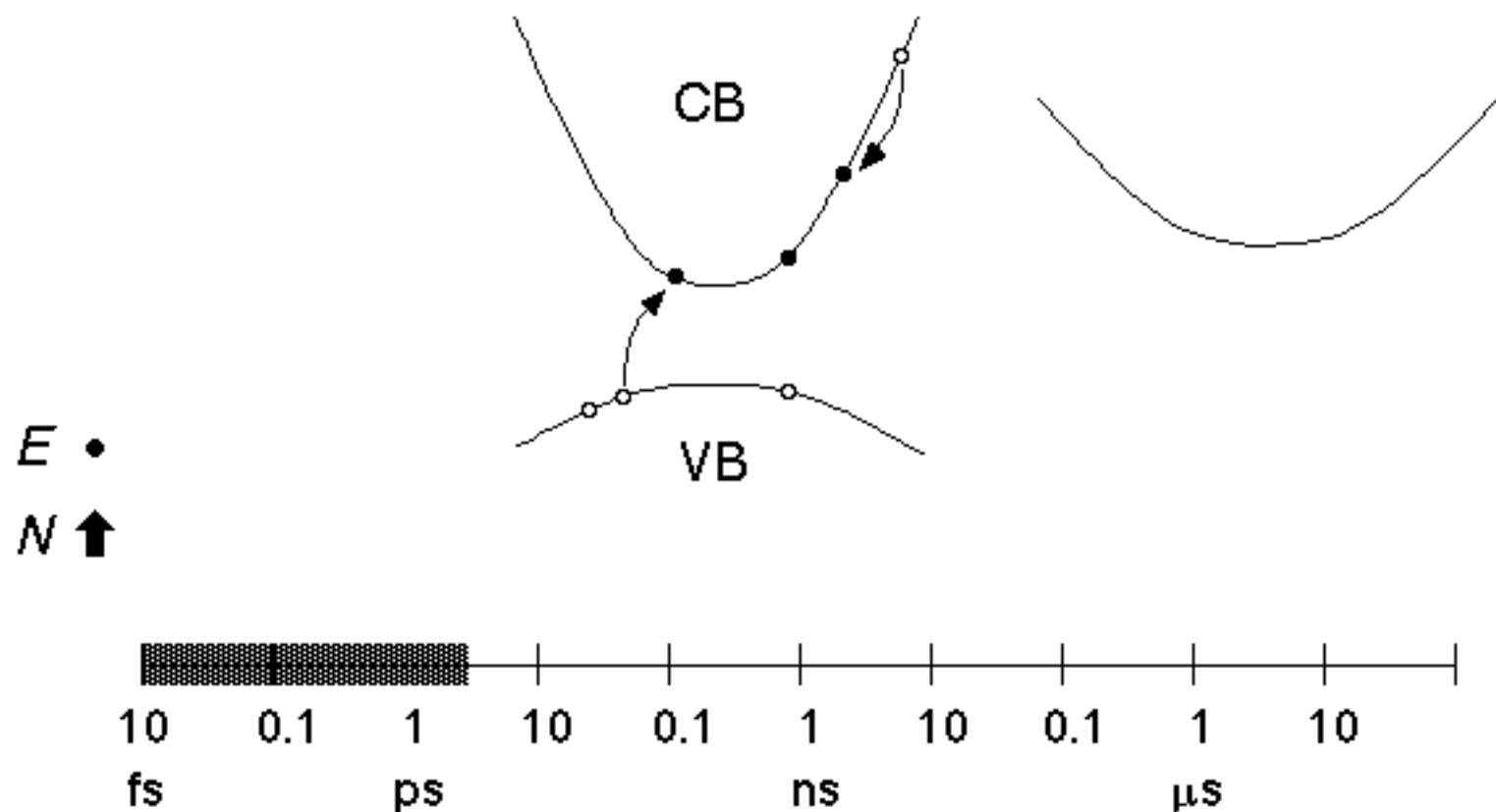

INTRODUCTION

carrier-carrier scattering

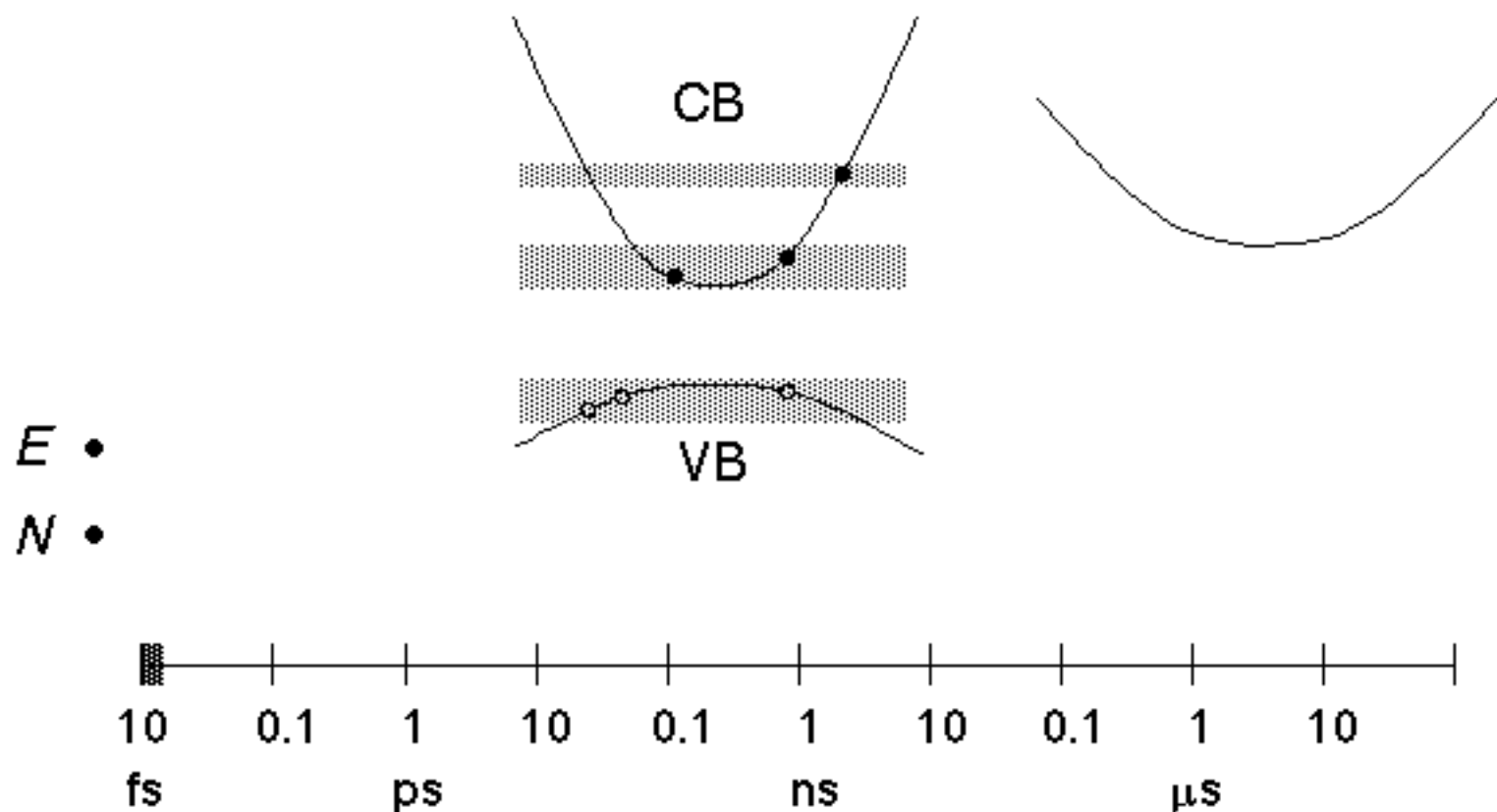

INTRODUCTION

carrier-carrier scattering

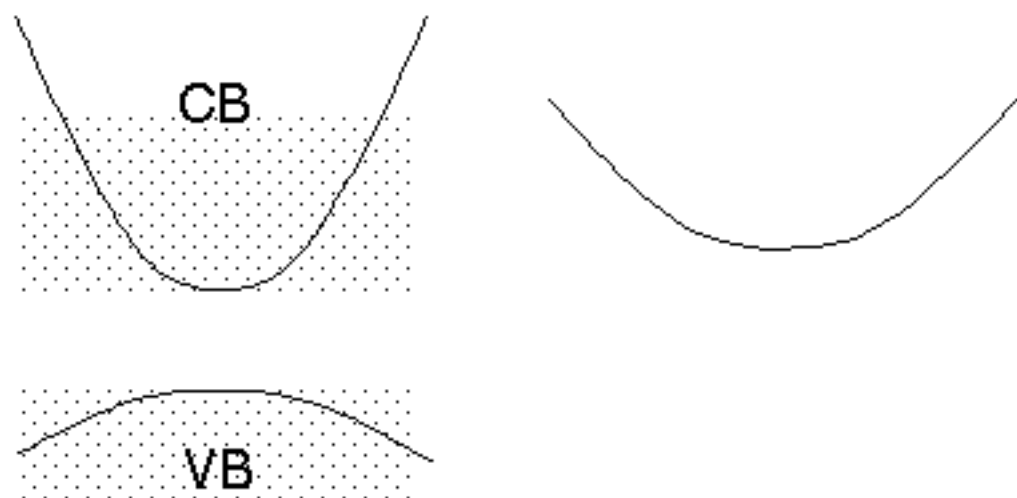

E •

N •

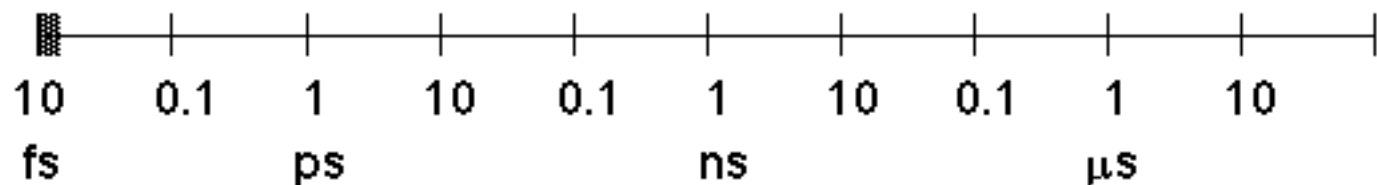

INTRODUCTION

carrier-phonon scattering

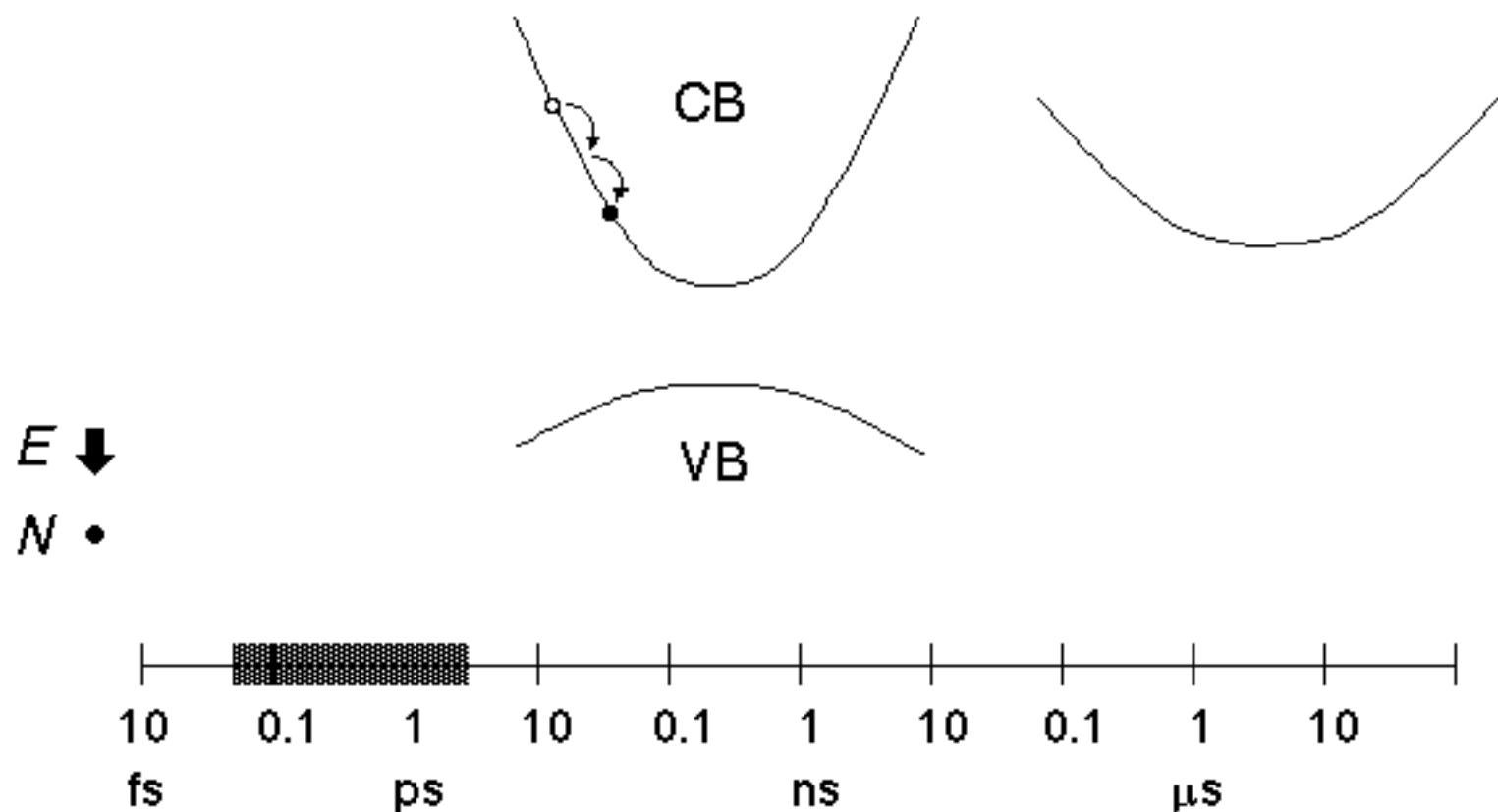

INTRODUCTION

carrier-phonon scattering

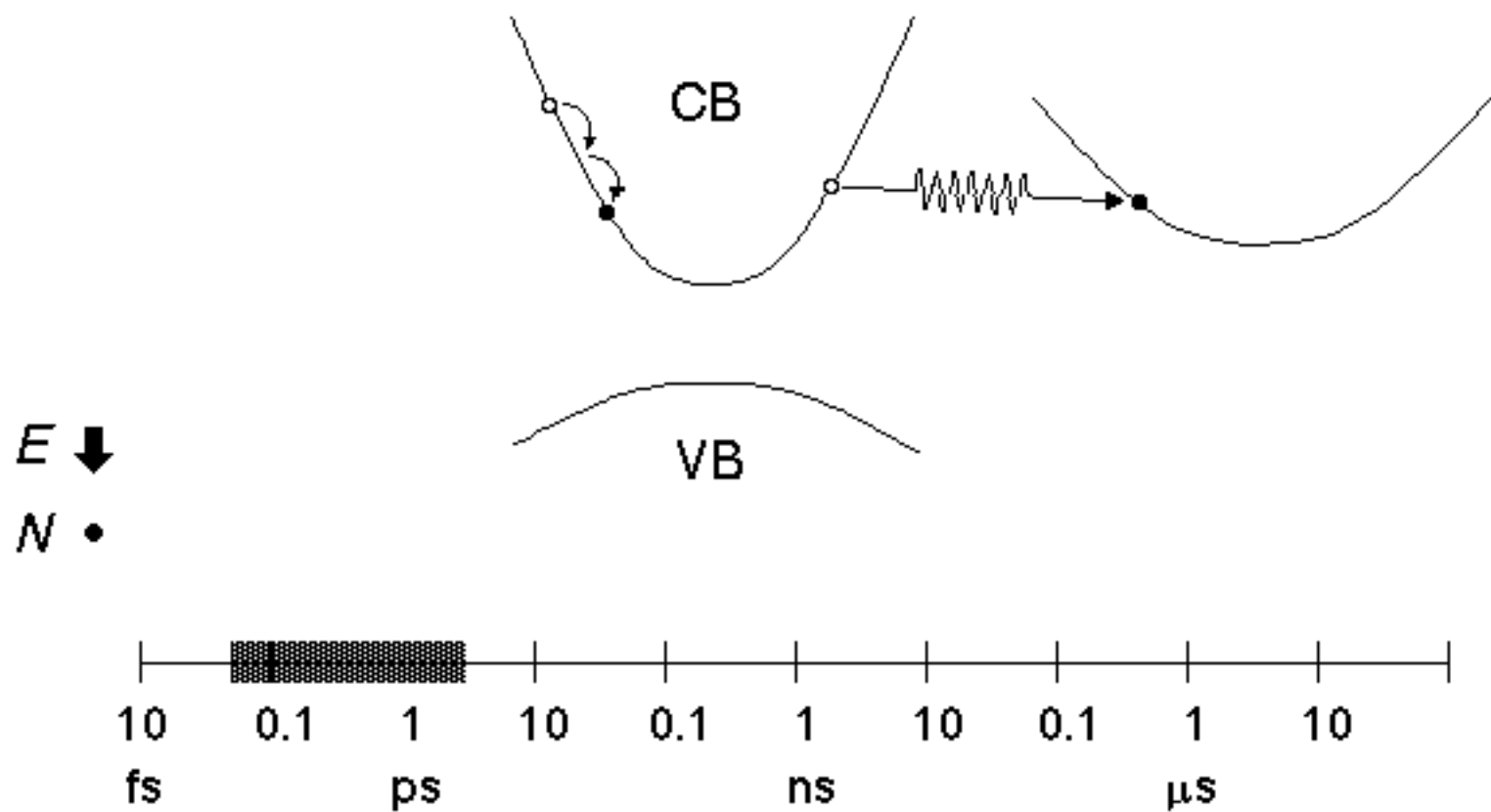

INTRODUCTION

Auger recombination

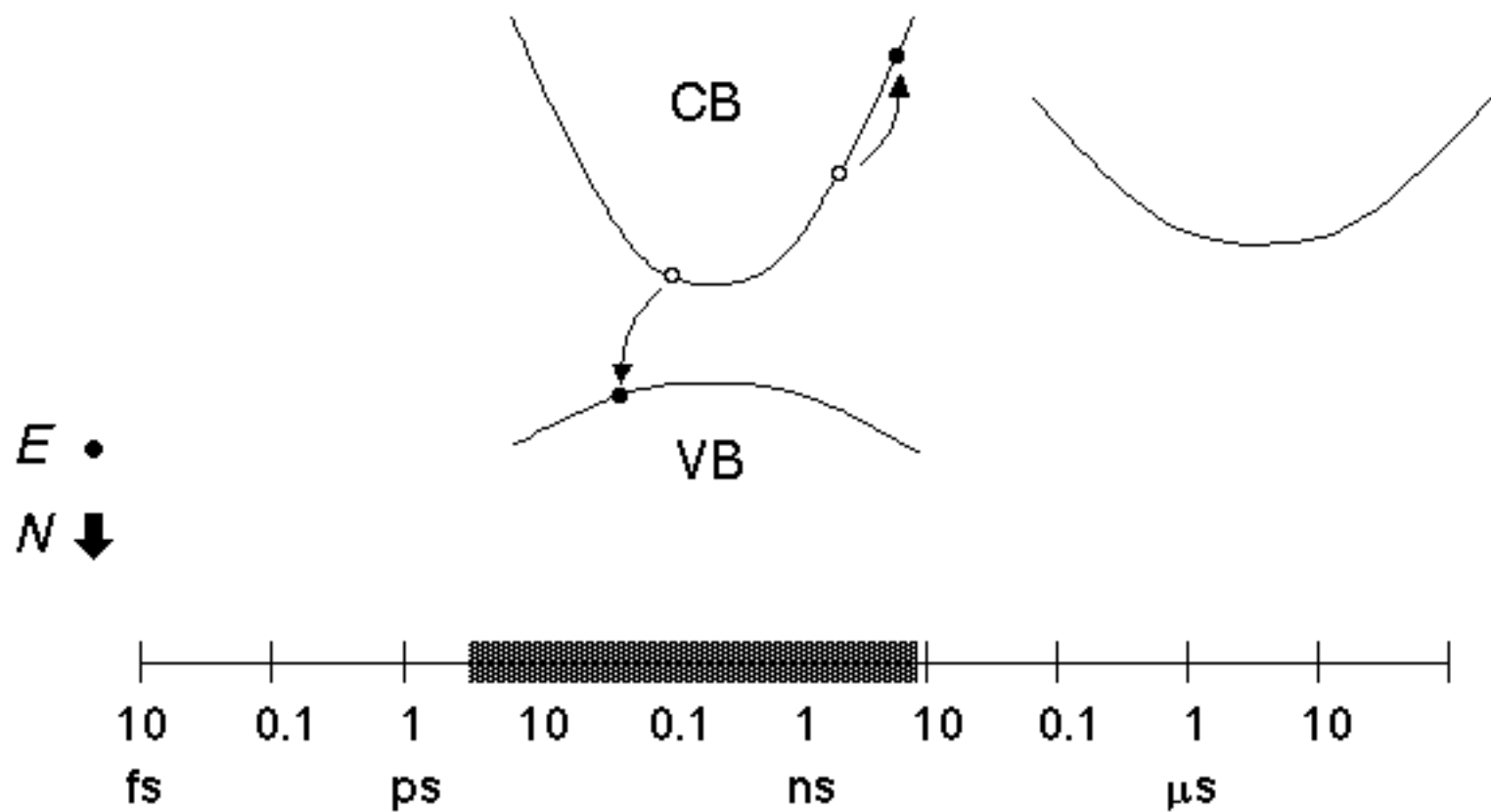

INTRODUCTION

radiative recombination

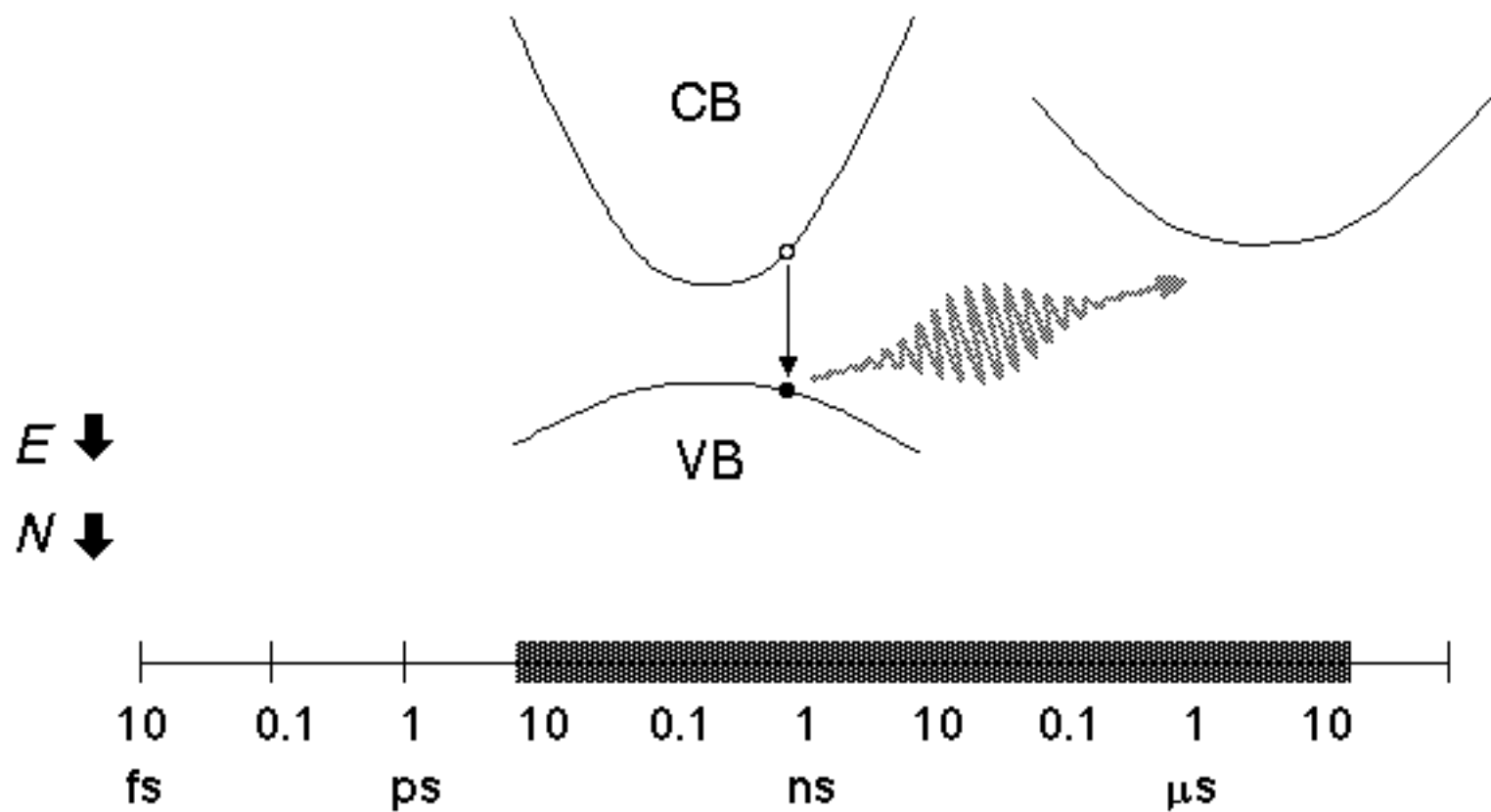

INTRODUCTION

carrier diffusion

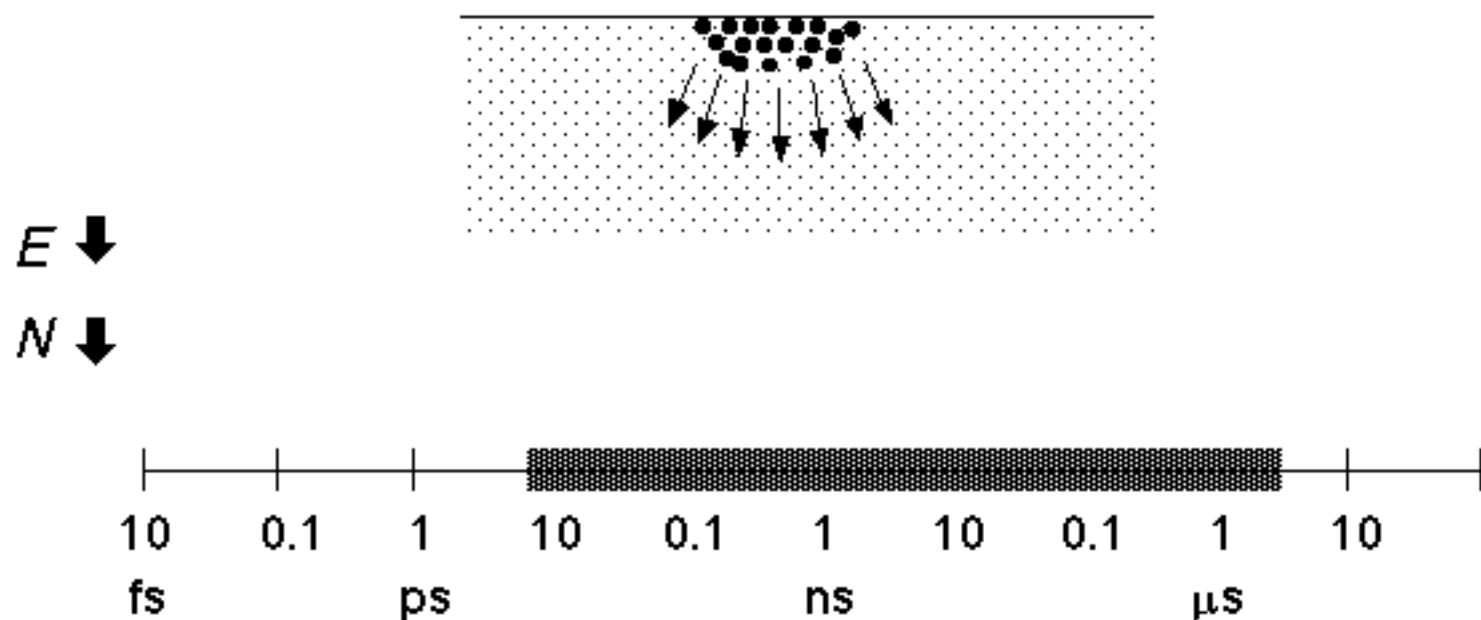

INTRODUCTION

thermal diffusion

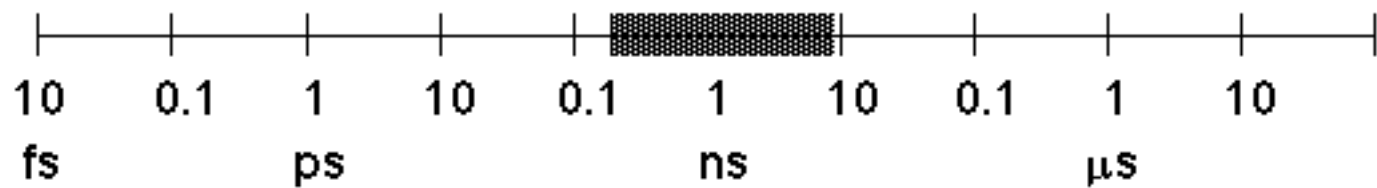
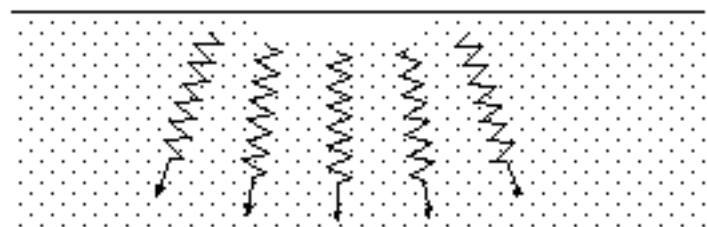

INTRODUCTION

ablation & evaporation

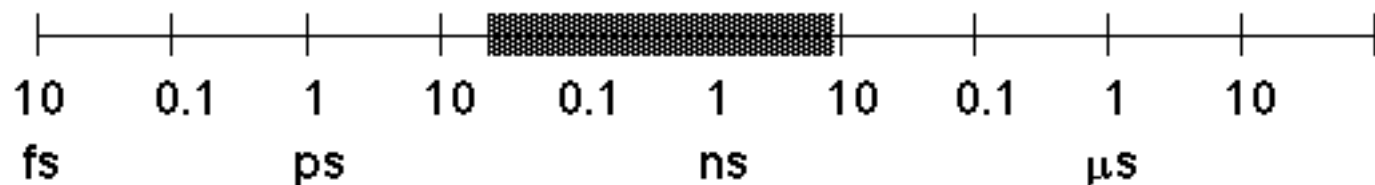
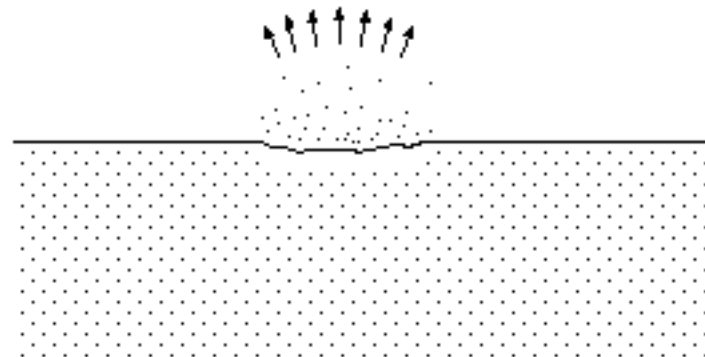

INTRODUCTION

resolidification

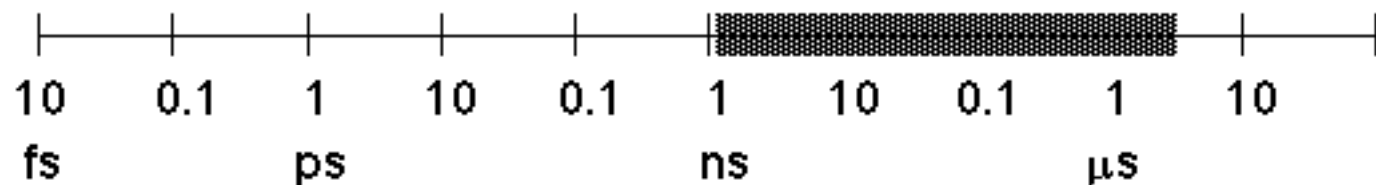

INTRODUCTION

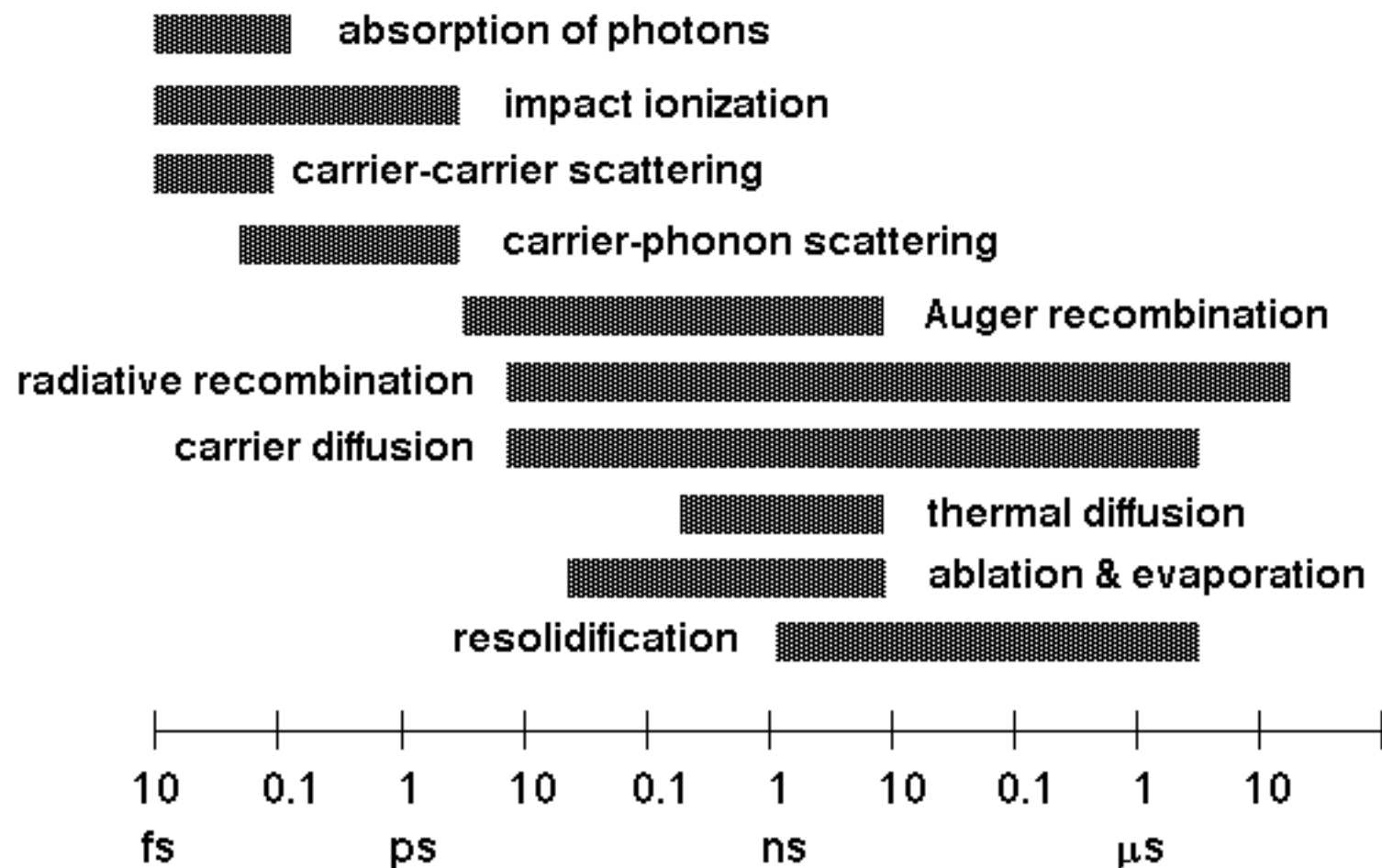

INTRODUCTION

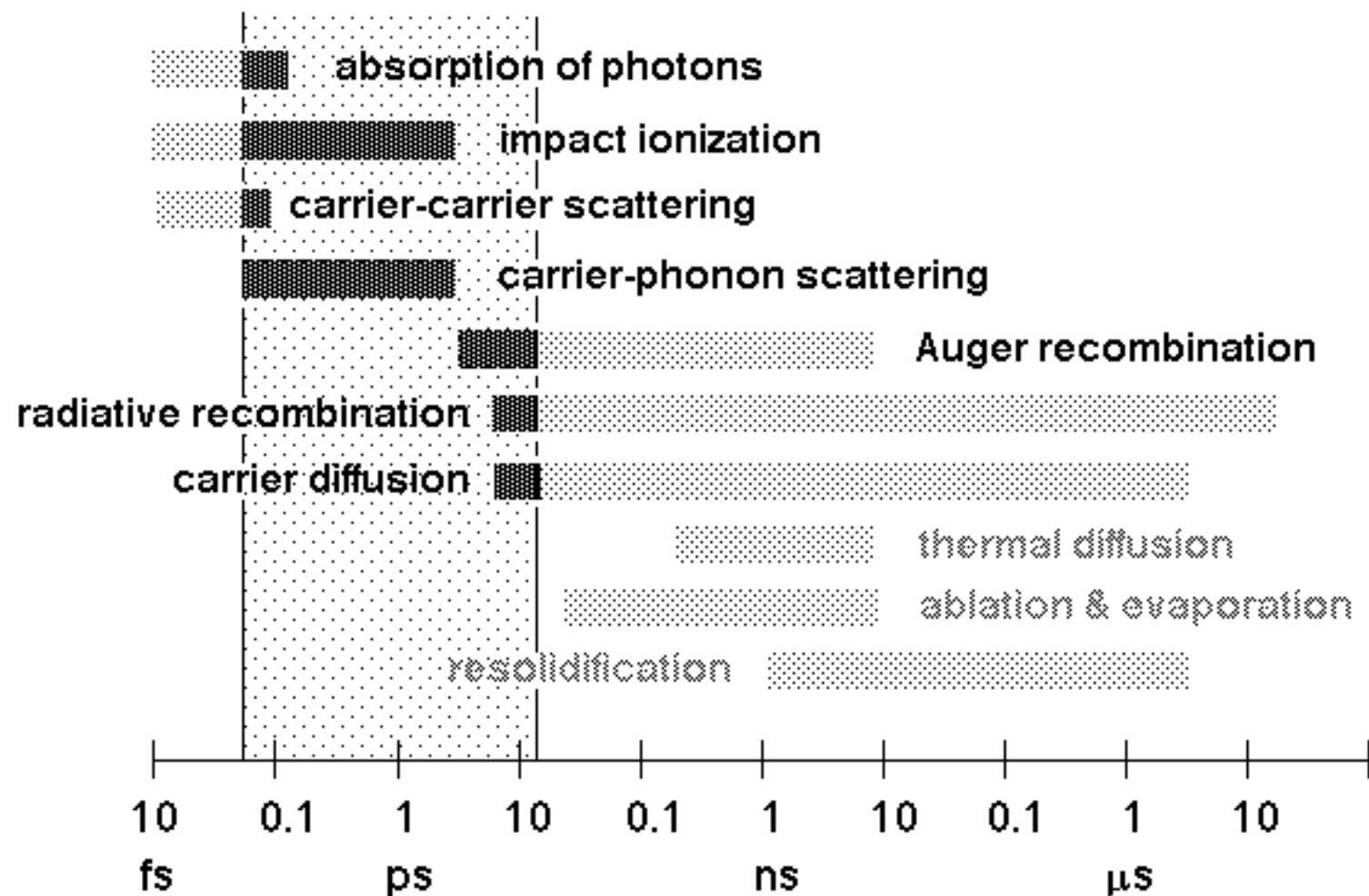

INTRODUCTION

structure

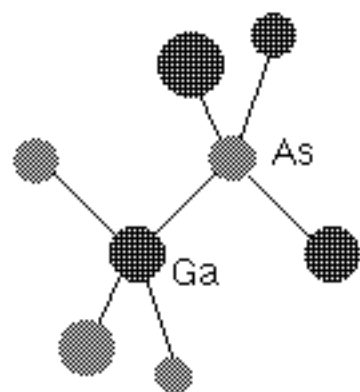

INTRODUCTION

structure

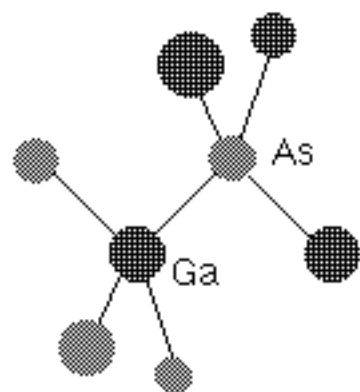

INTRODUCTION

structure

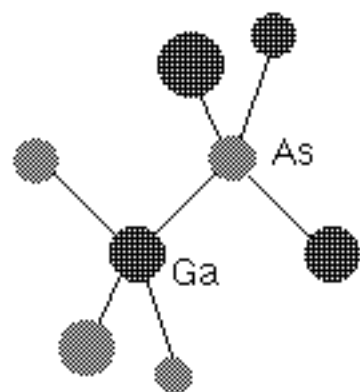

bandstructure

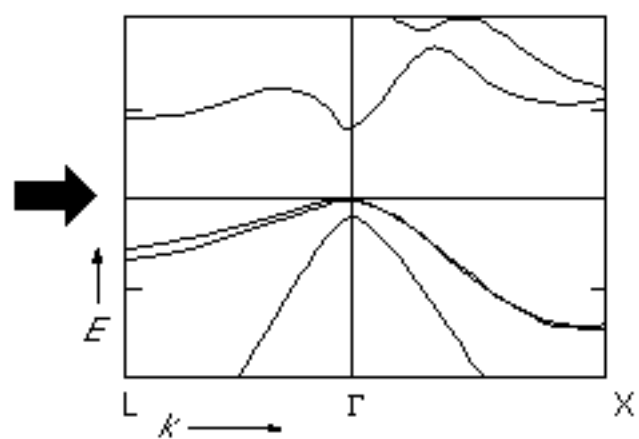

INTRODUCTION

structure

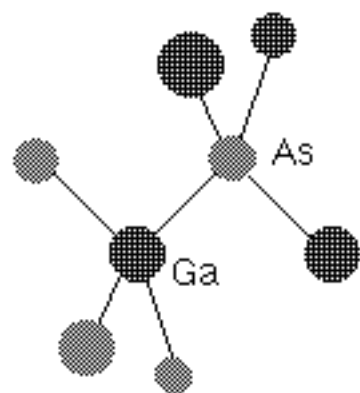

bandstructure

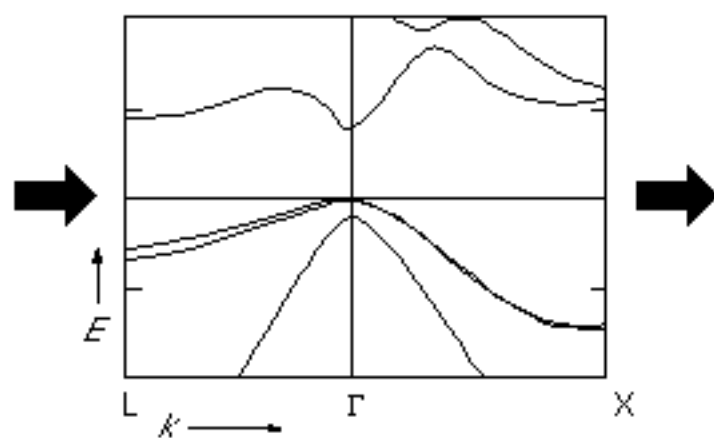

INTRODUCTION

structure

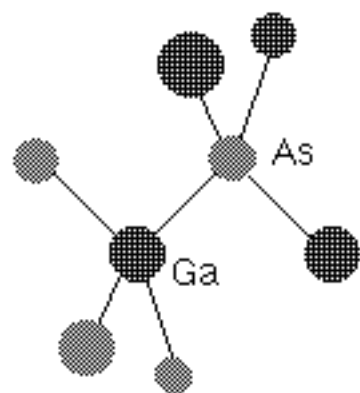

bandstructure

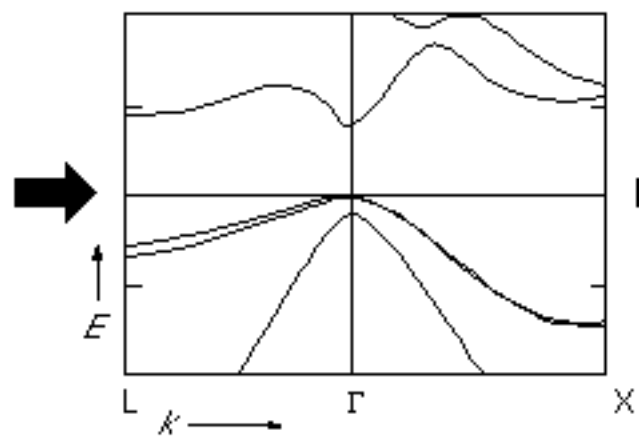

dielectric function

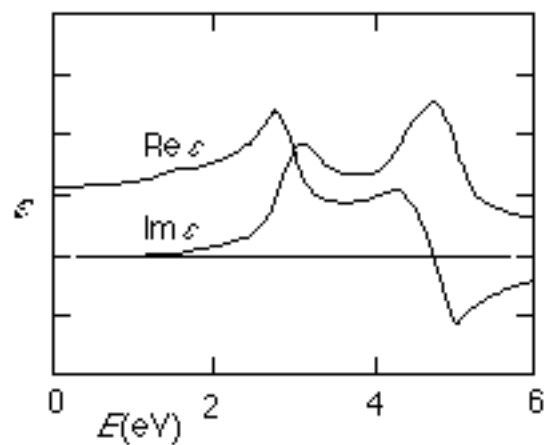

INTRODUCTION

structure

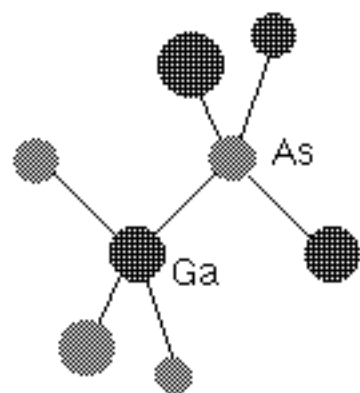

bandstructure

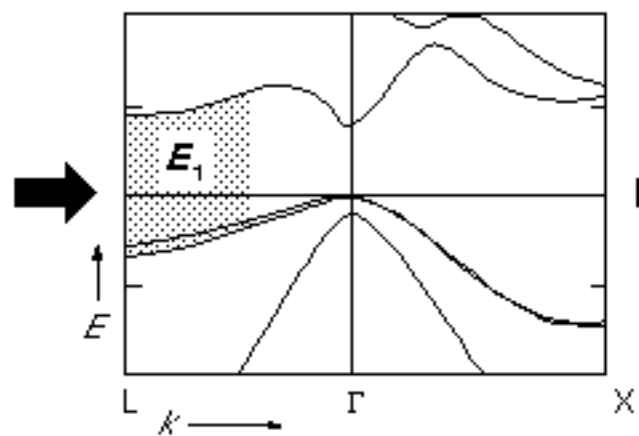

dielectric function

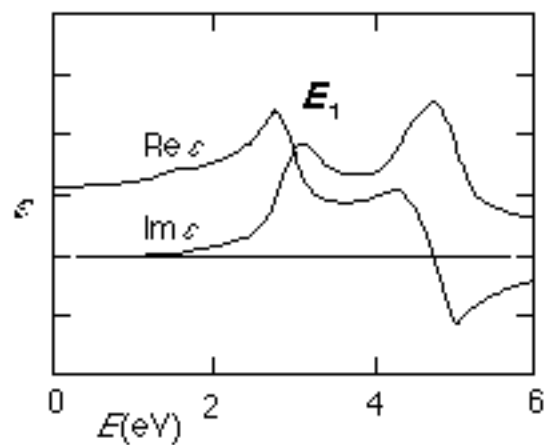

INTRODUCTION

structure

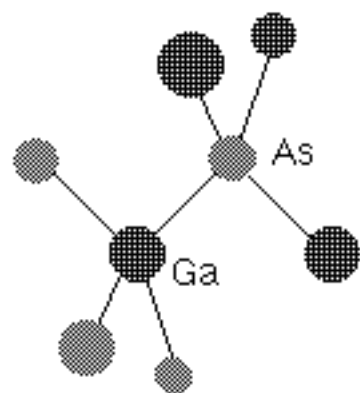

bandstructure

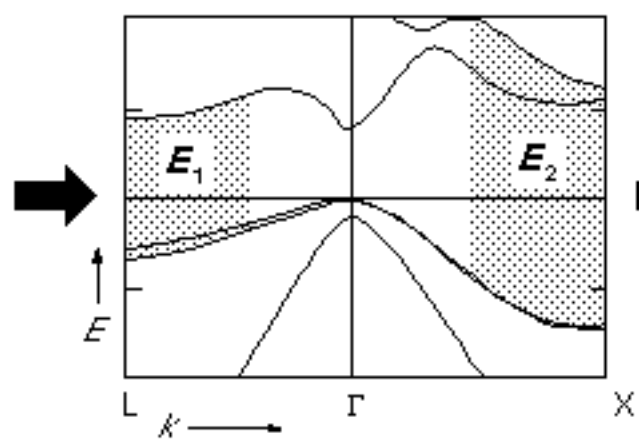

dielectric function

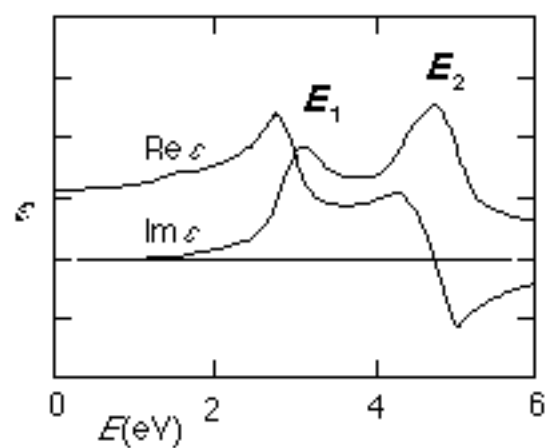

INTRODUCTION

structure

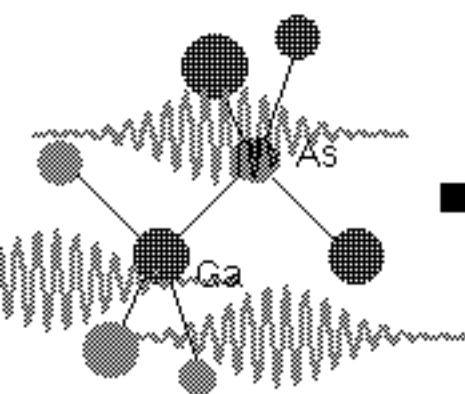

70 fs, 10^{16} W/m²

bandstructure

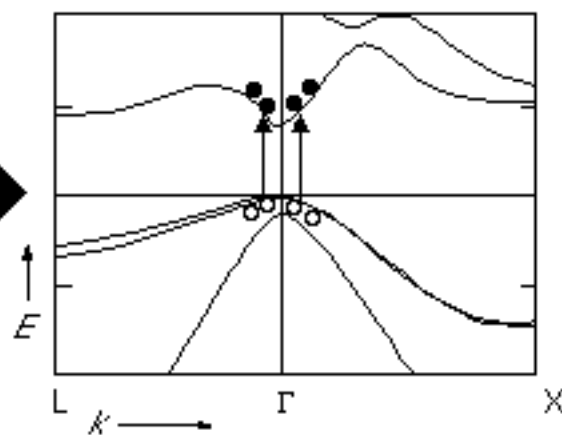

$10^{20} - 10^{22}$ cm⁻³

dielectric function

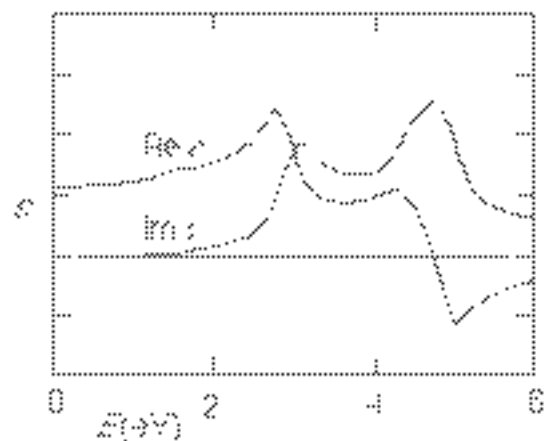

INTRODUCTION

structure

bandstructure

dielectric function

?

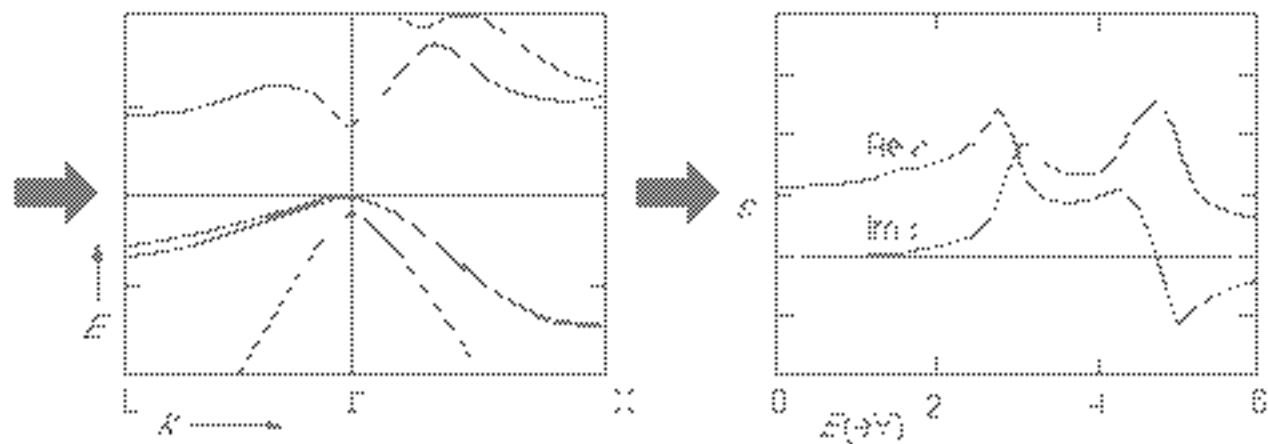

INTRODUCTION

structure

bandstructure

dielectric function

?

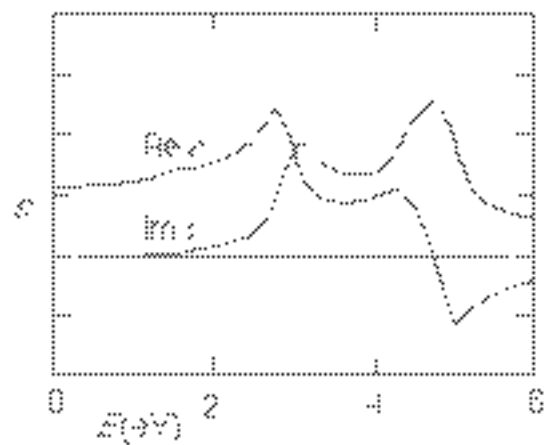
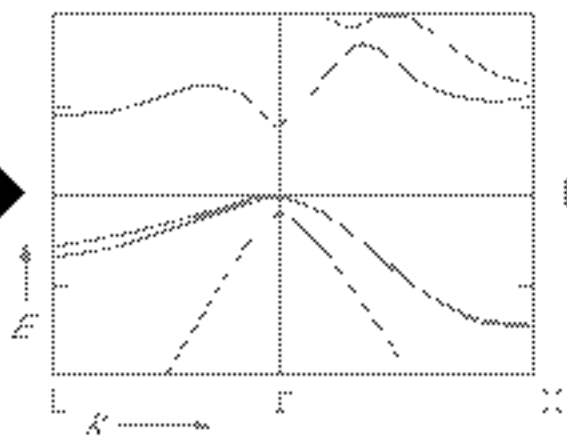

INTRODUCTION

structure

?



bandstructure

?



dielectric function

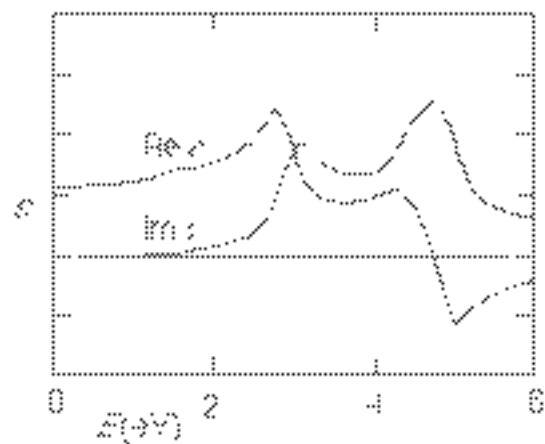
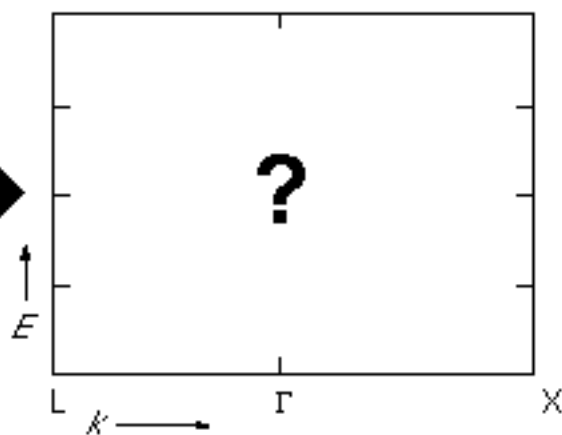

INTRODUCTION

structure

?



bandstructure

?



dielectric function

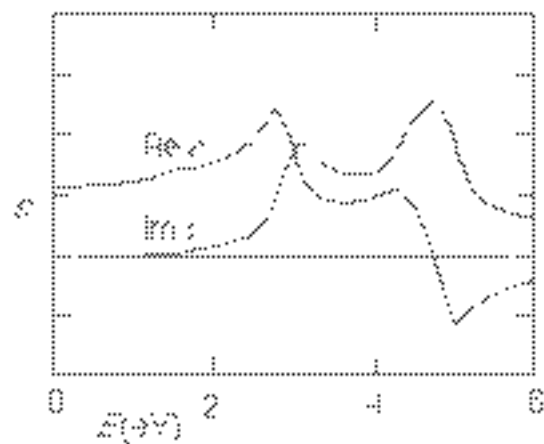
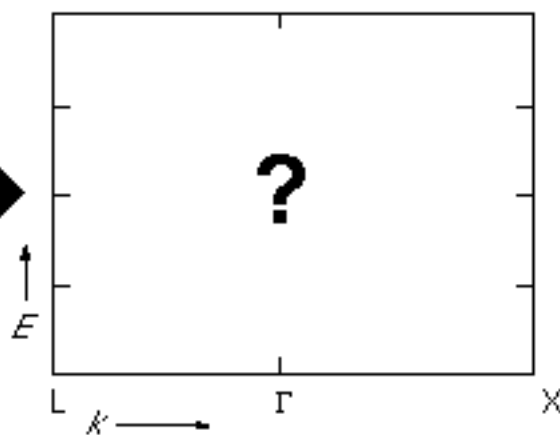

INTRODUCTION

structure

?



bandstructure

?



dielectric function

?

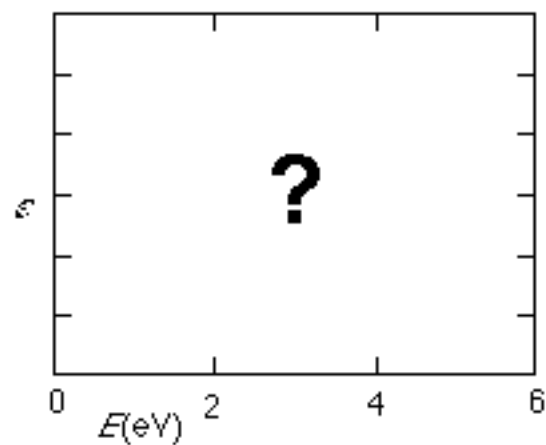
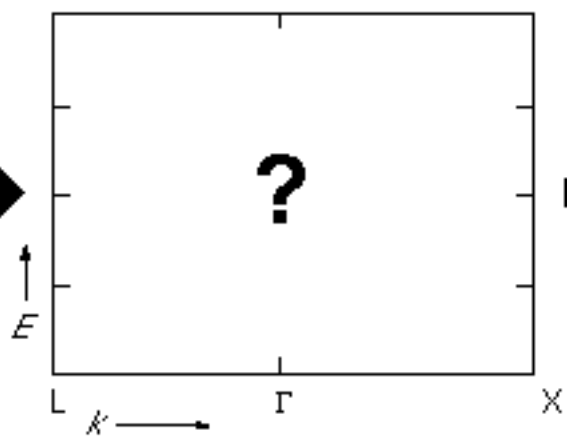

INTRODUCTION

structure

?

bandstructure

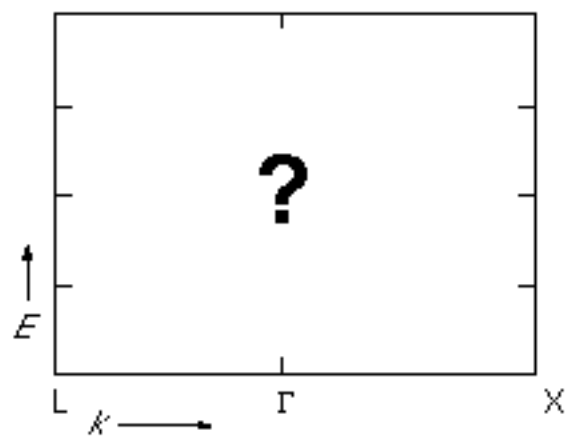

dielectric function

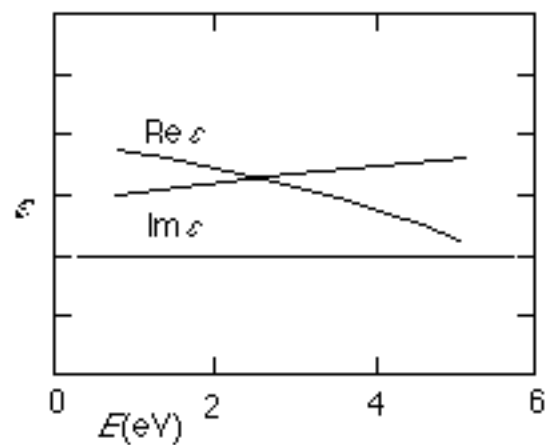

INTRODUCTION

structure

bandstructure

dielectric function

?

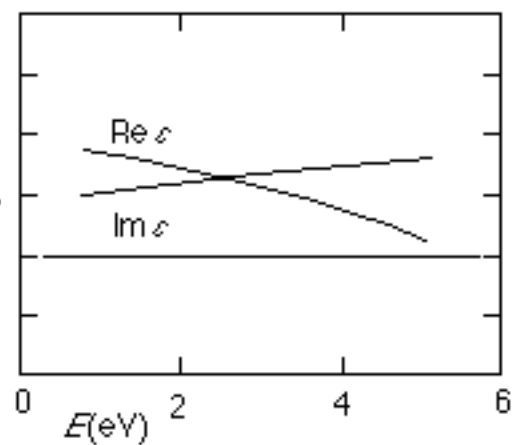
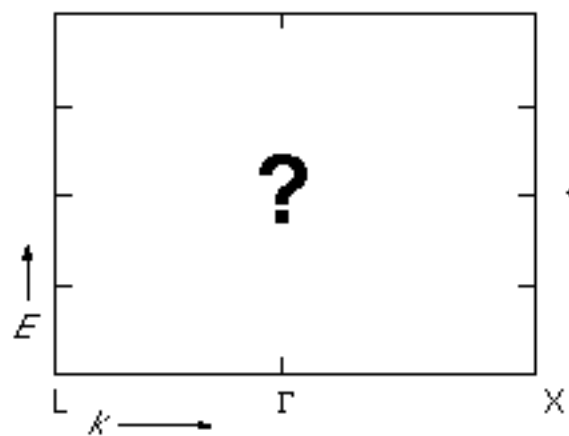

INTRODUCTION

structure

bandstructure

dielectric function

?

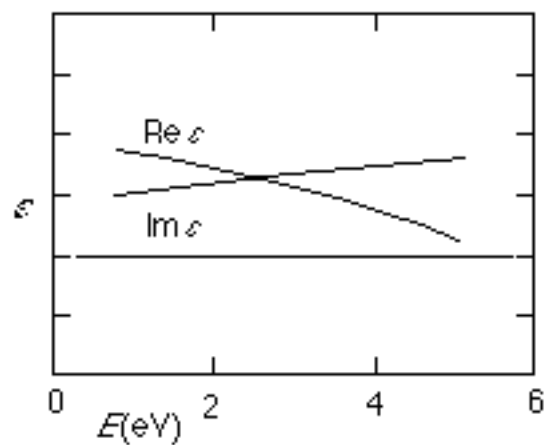
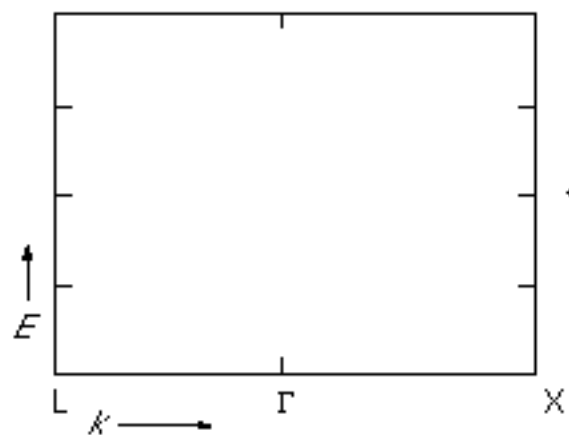

INTRODUCTION

structure

bandstructure

dielectric function

?

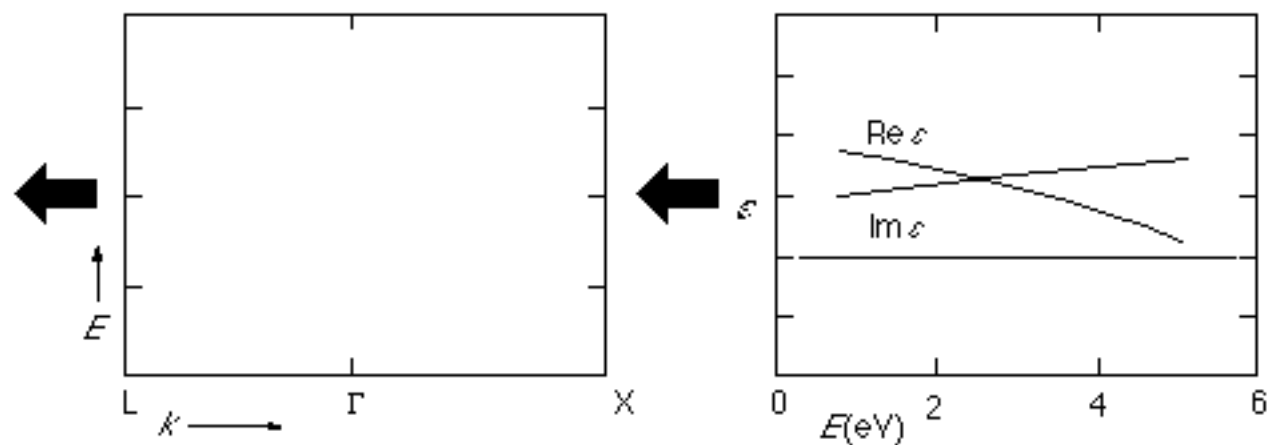

INTRODUCTION

structure

bandstructure

dielectric function

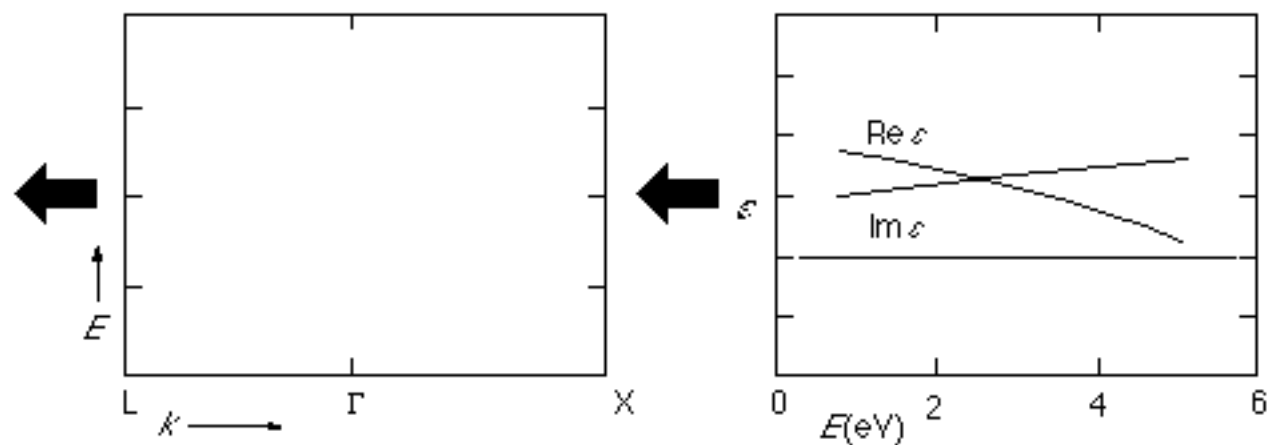

DIELECTRIC FUNCTION

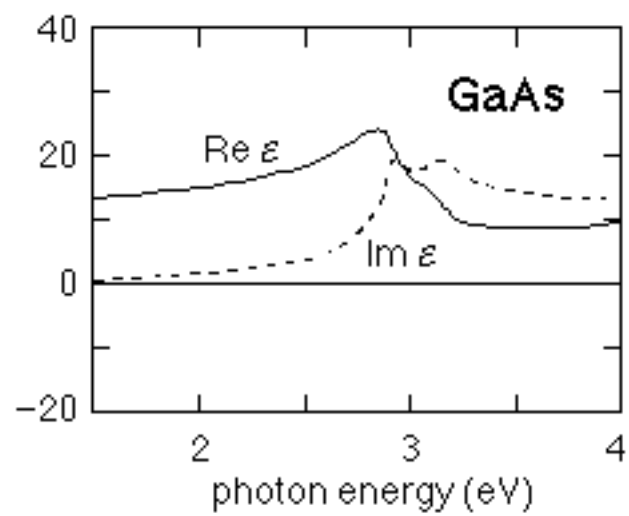

DIELECTRIC FUNCTION

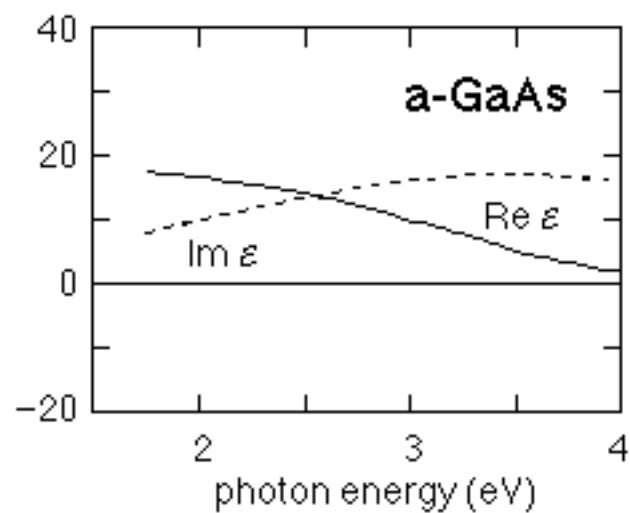
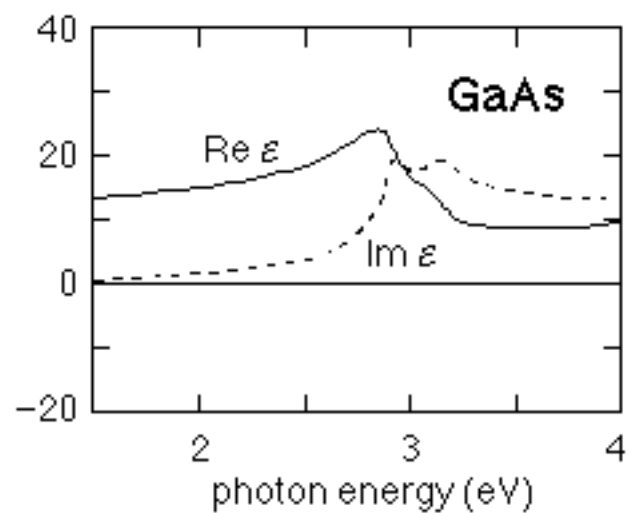

DIELECTRIC FUNCTION

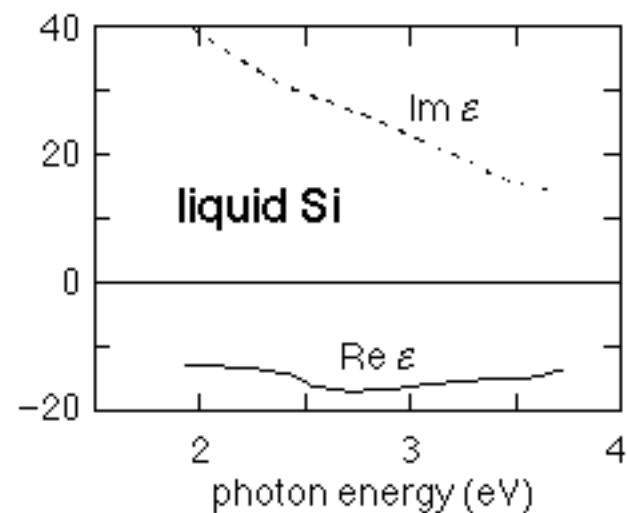
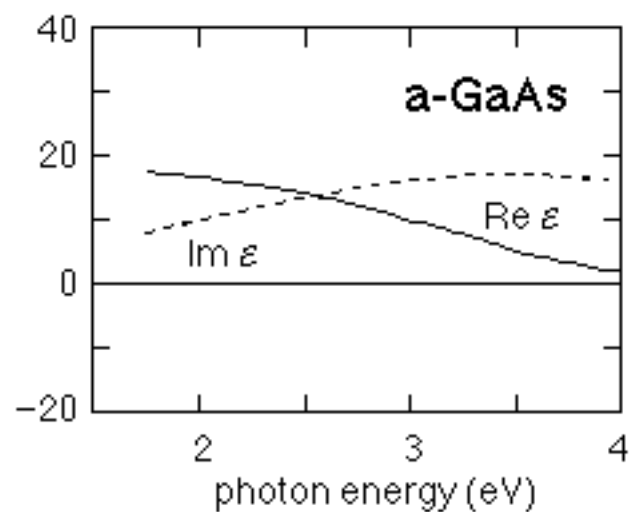
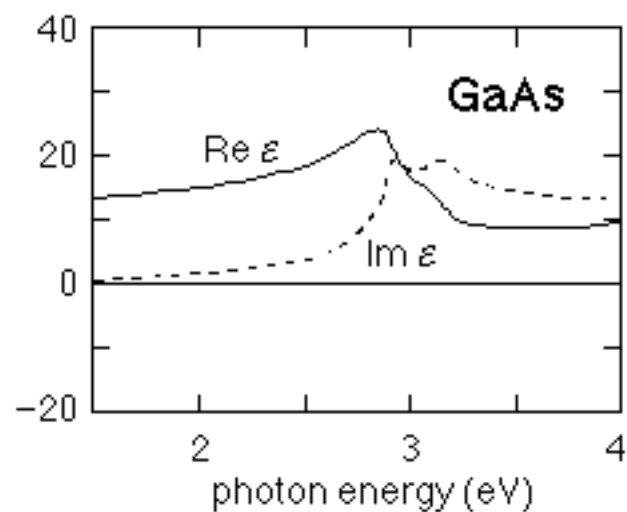

DIELECTRIC FUNCTION

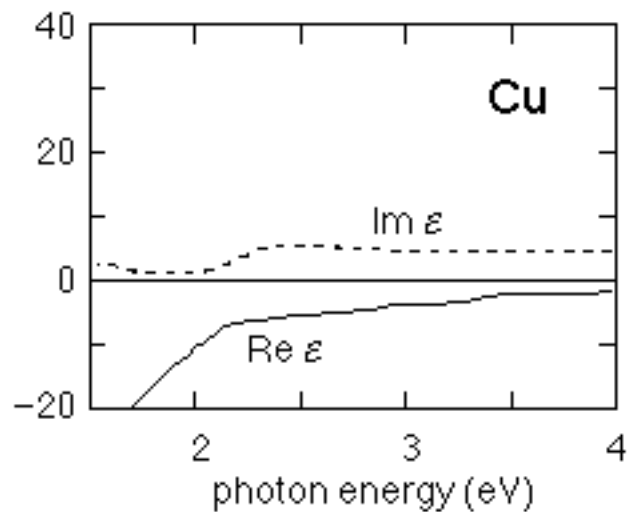
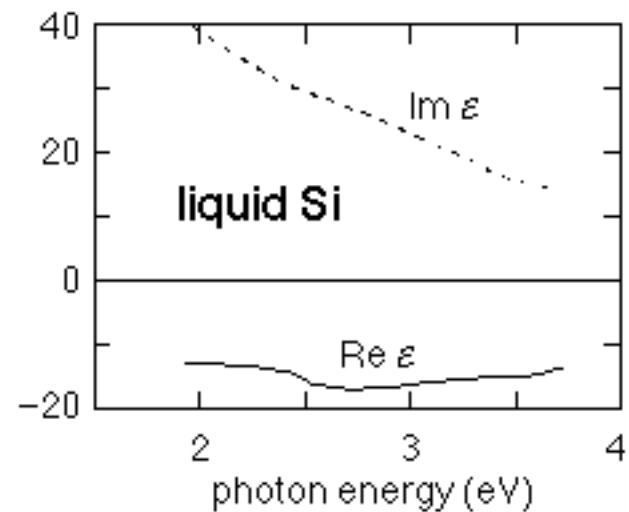
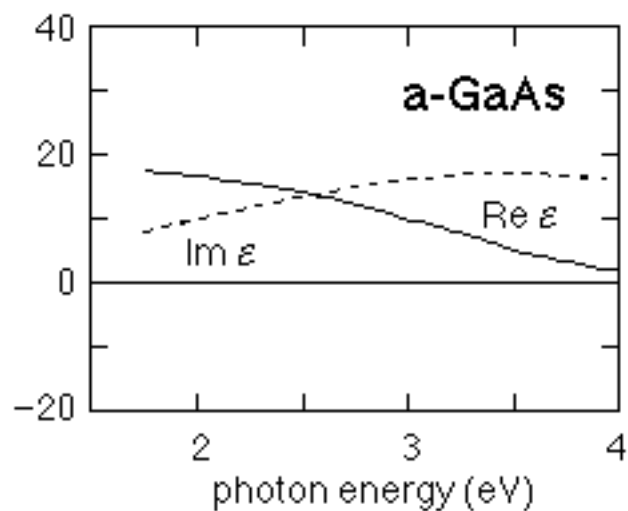
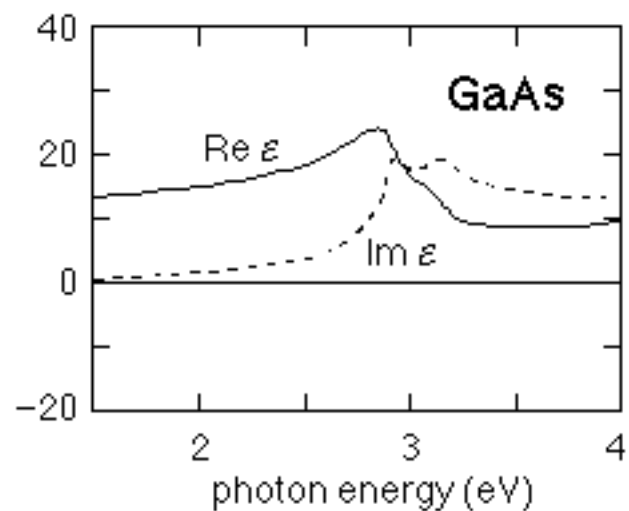

- ① Method
- ② Results
- ③ Discussion



PUMP & PROBE MEASUREMENT

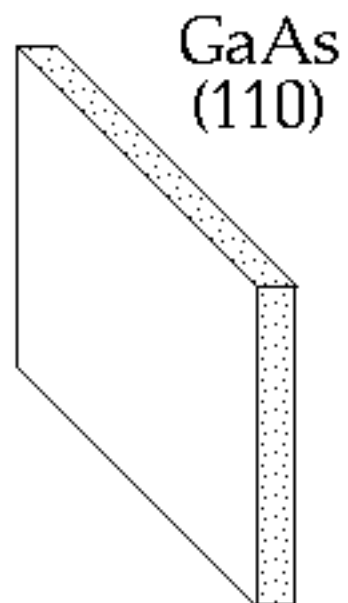

PUMP & PROBE MEASUREMENT

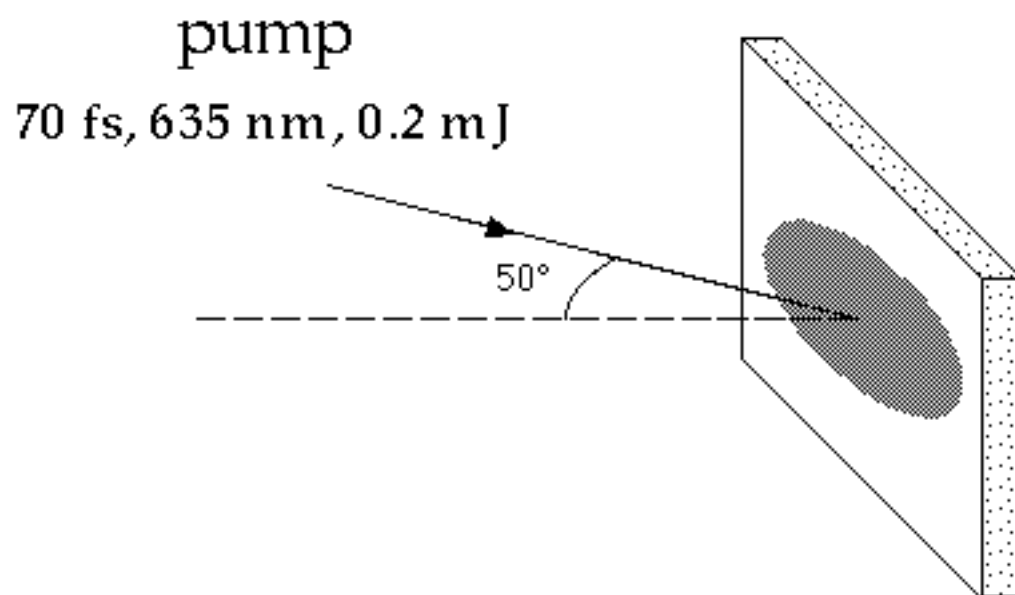

PUMP & PROBE MEASUREMENT

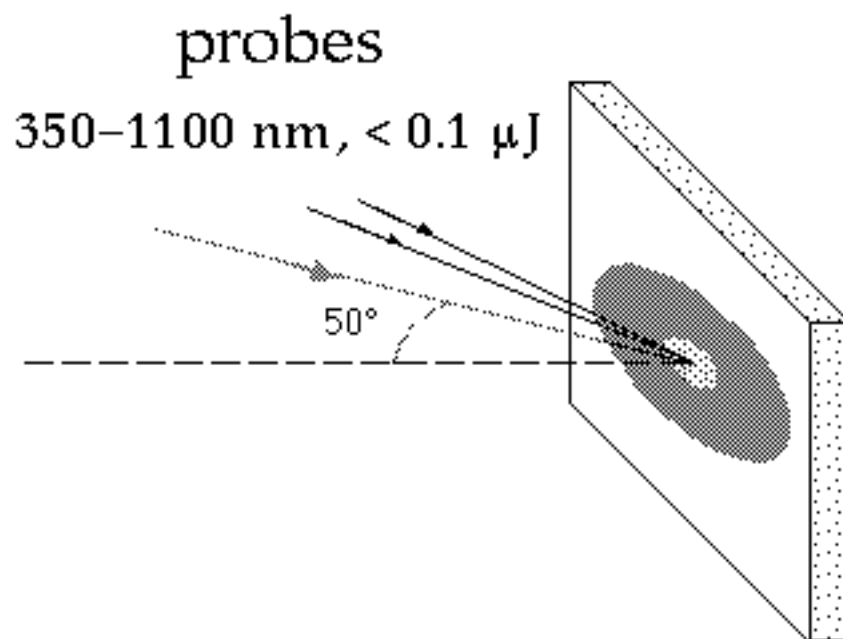

PUMP & PROBE MEASUREMENT

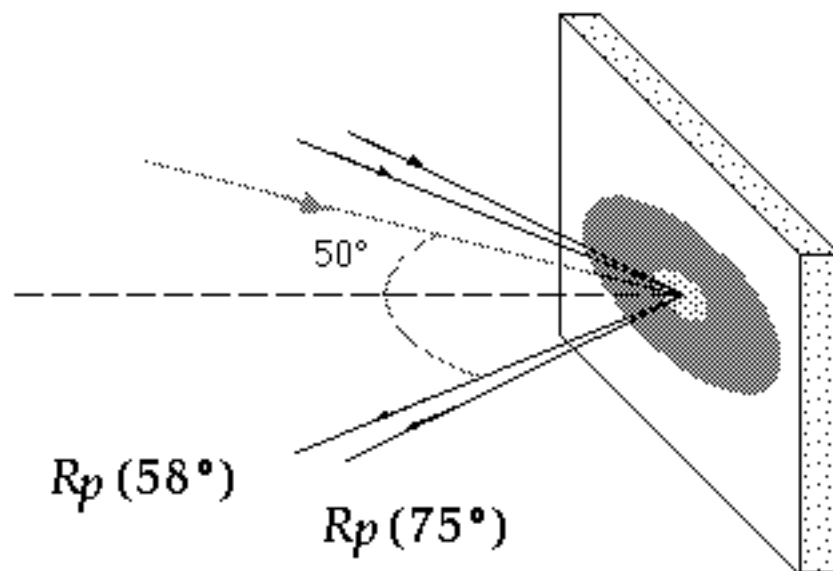

PUMP & PROBE MEASUREMENT

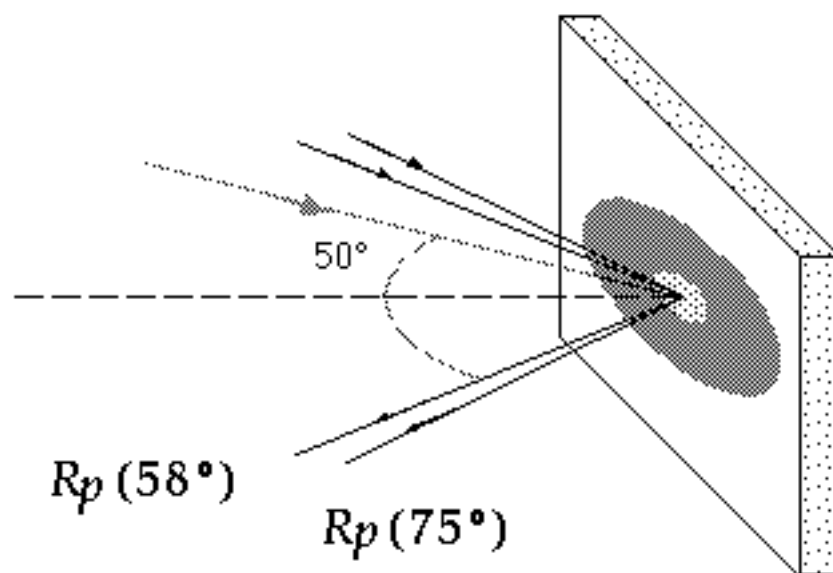

Fresnel
equations



PUMP & PROBE MEASUREMENT

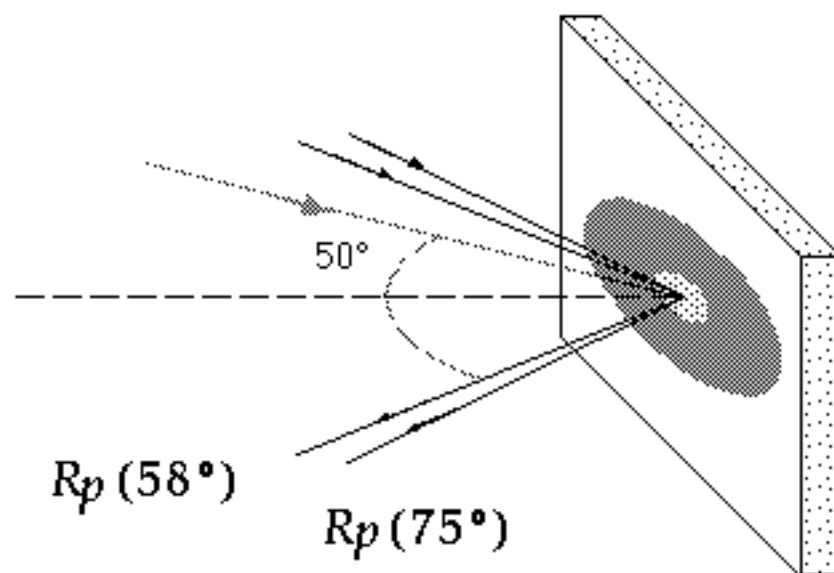

↓
Fresnel
equations



$\text{Re } \epsilon(\omega), \text{Im } \epsilon(\omega)$



SETUP

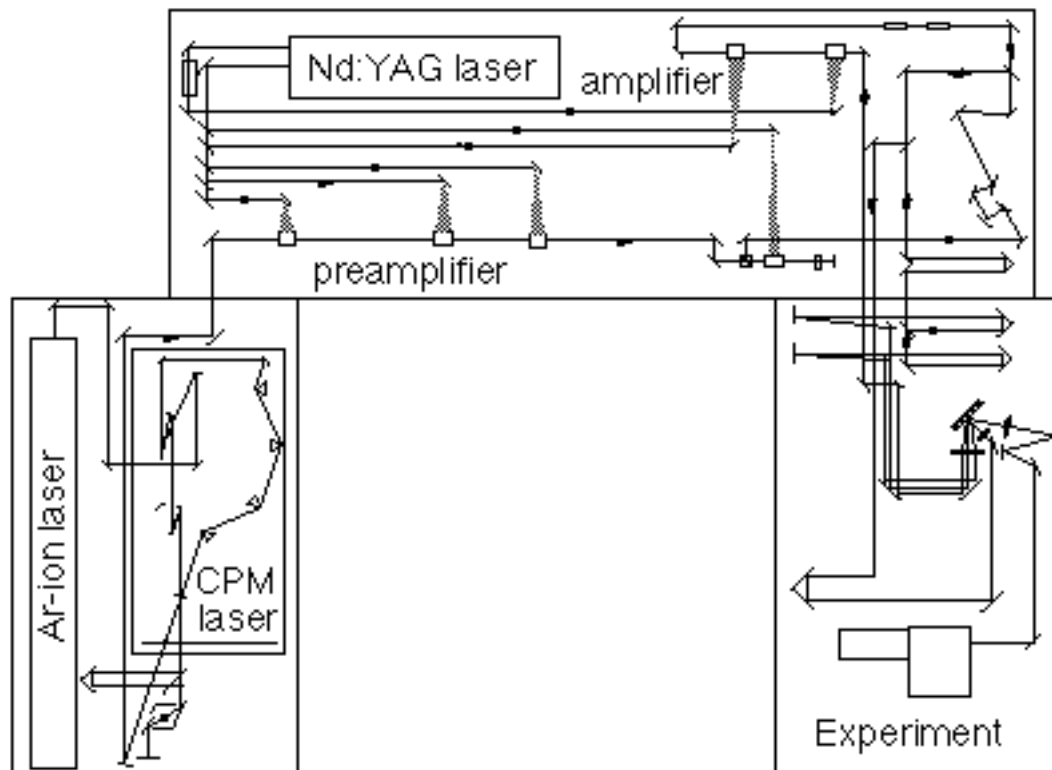

- ① Method
- ② Results
- ③ Discussion



WHAT IS HAPPENING?

structure

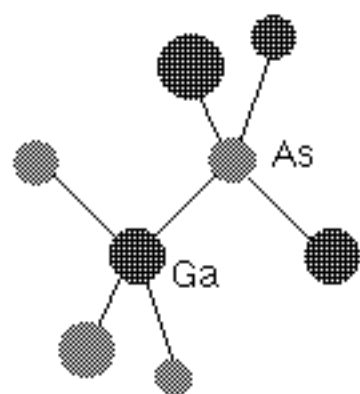

bandstructure

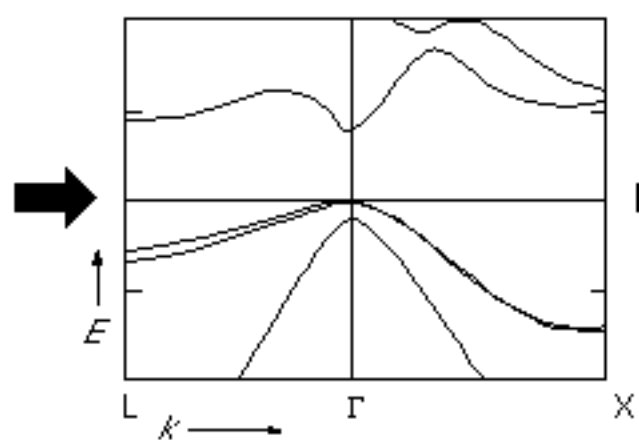

dielectric function

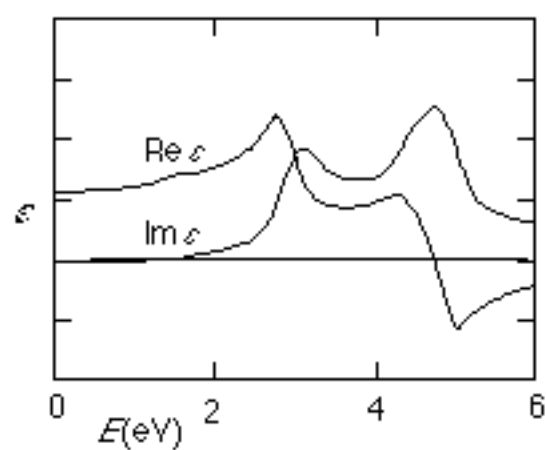

SECOND HARMONIC DATA

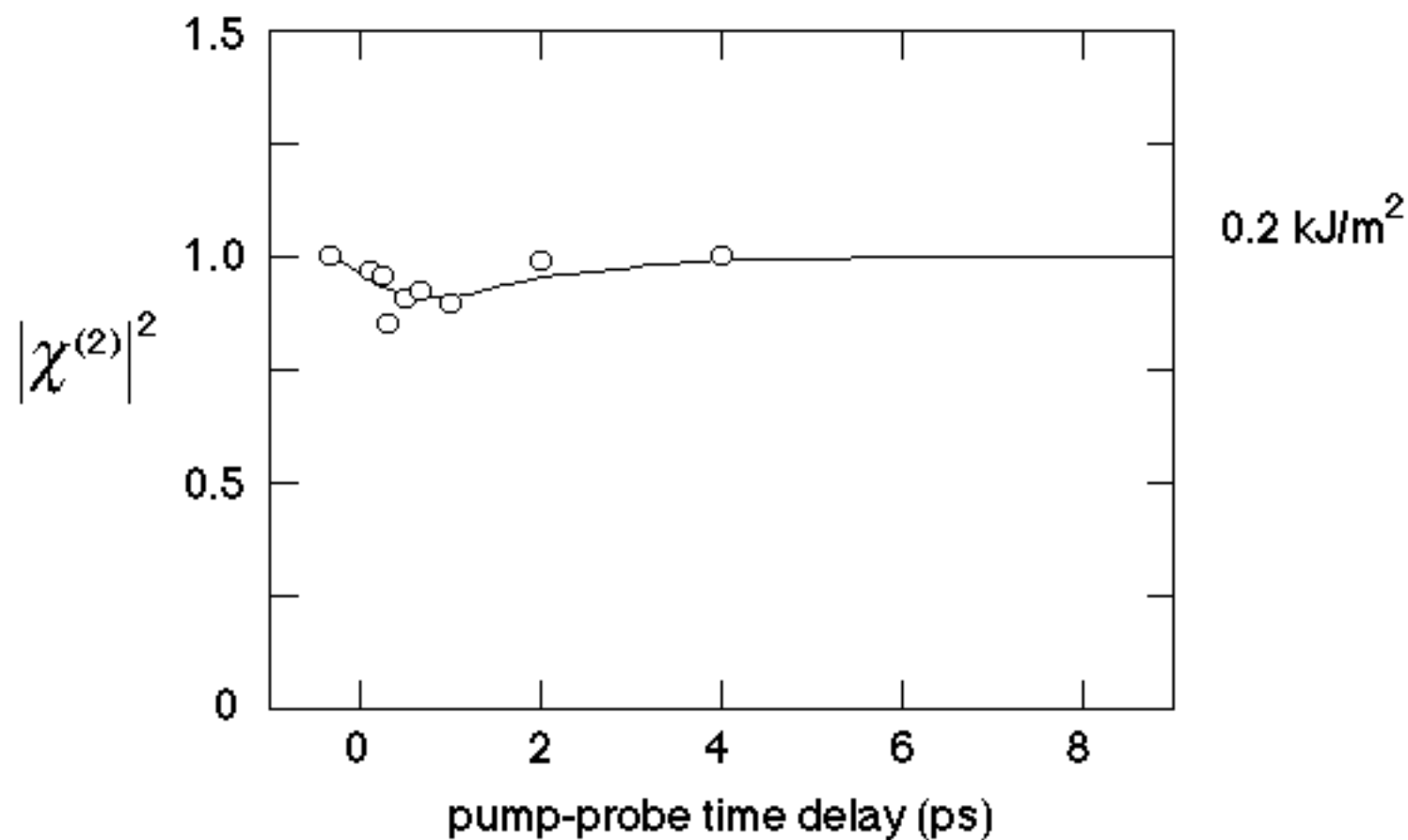

SECOND HARMONIC DATA

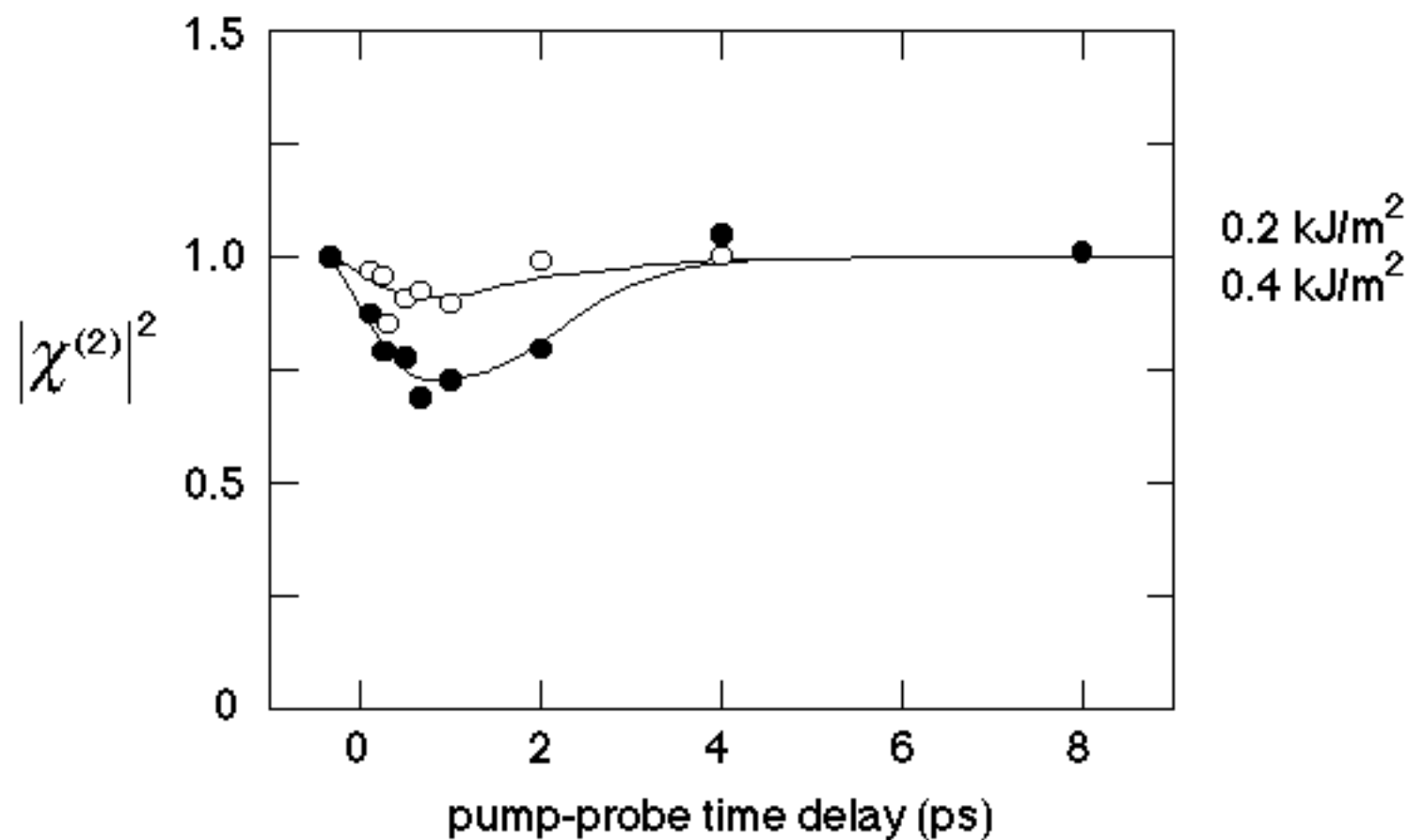

SECOND HARMONIC DATA

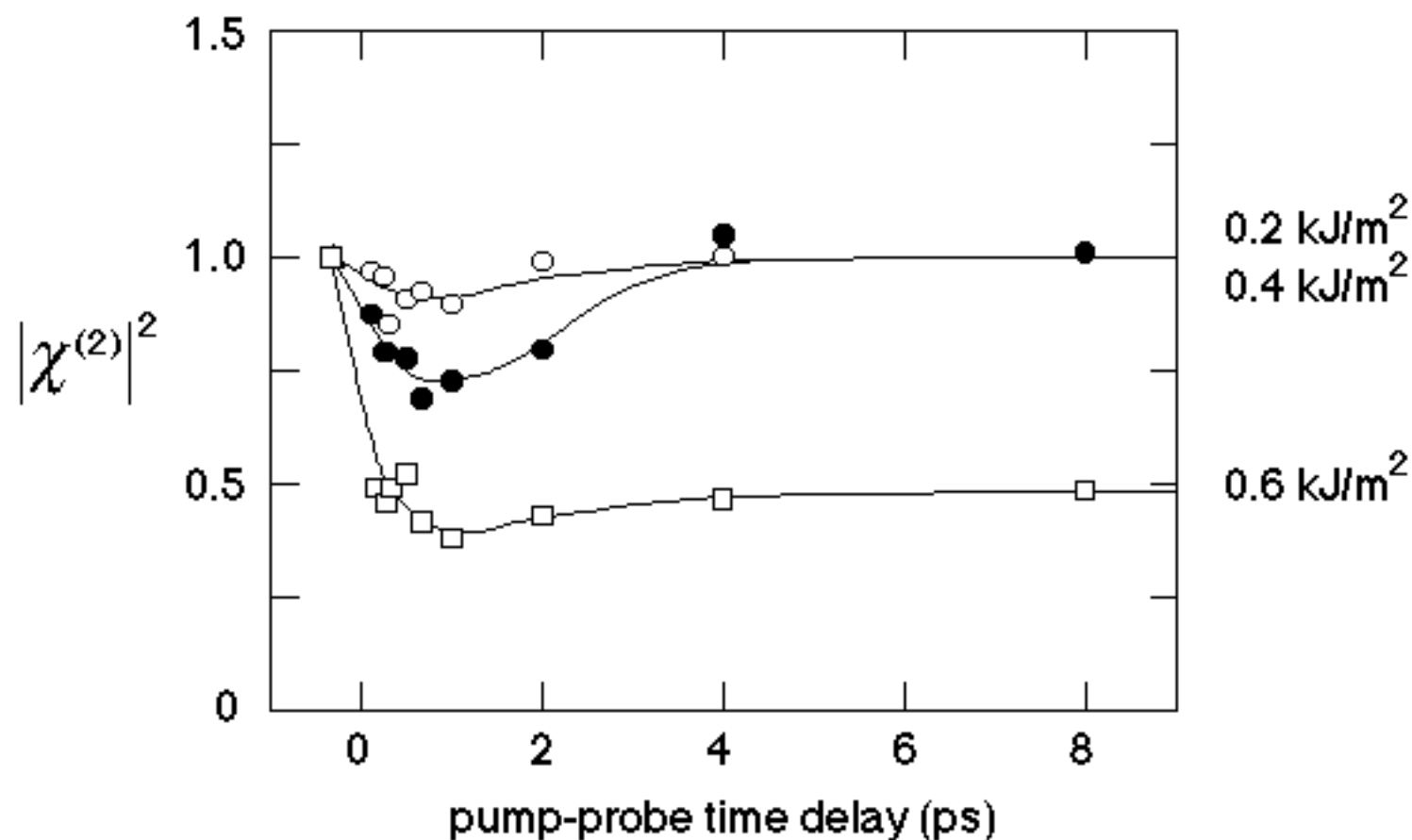

SECOND HARMONIC DATA

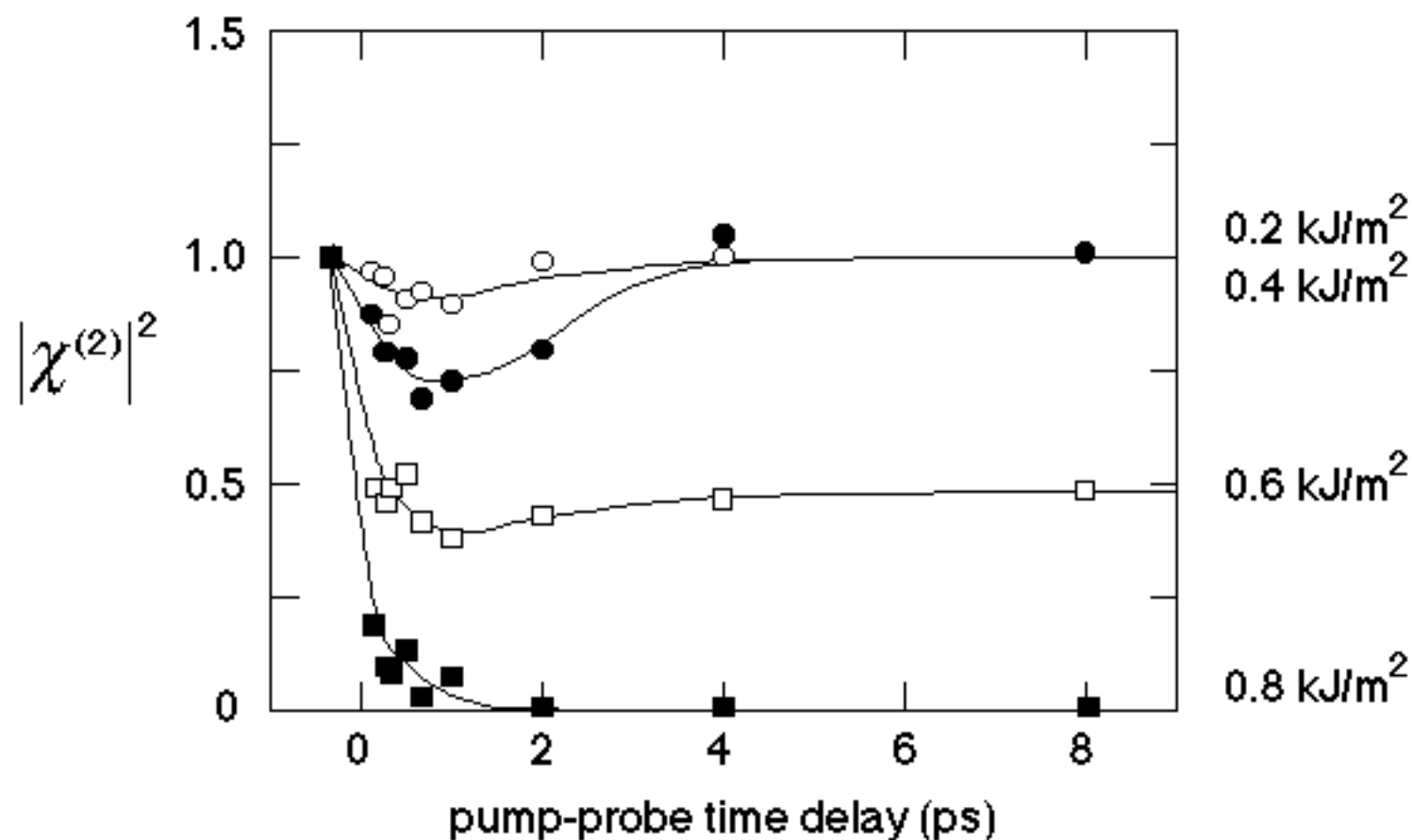

SECOND HARMONIC DATA

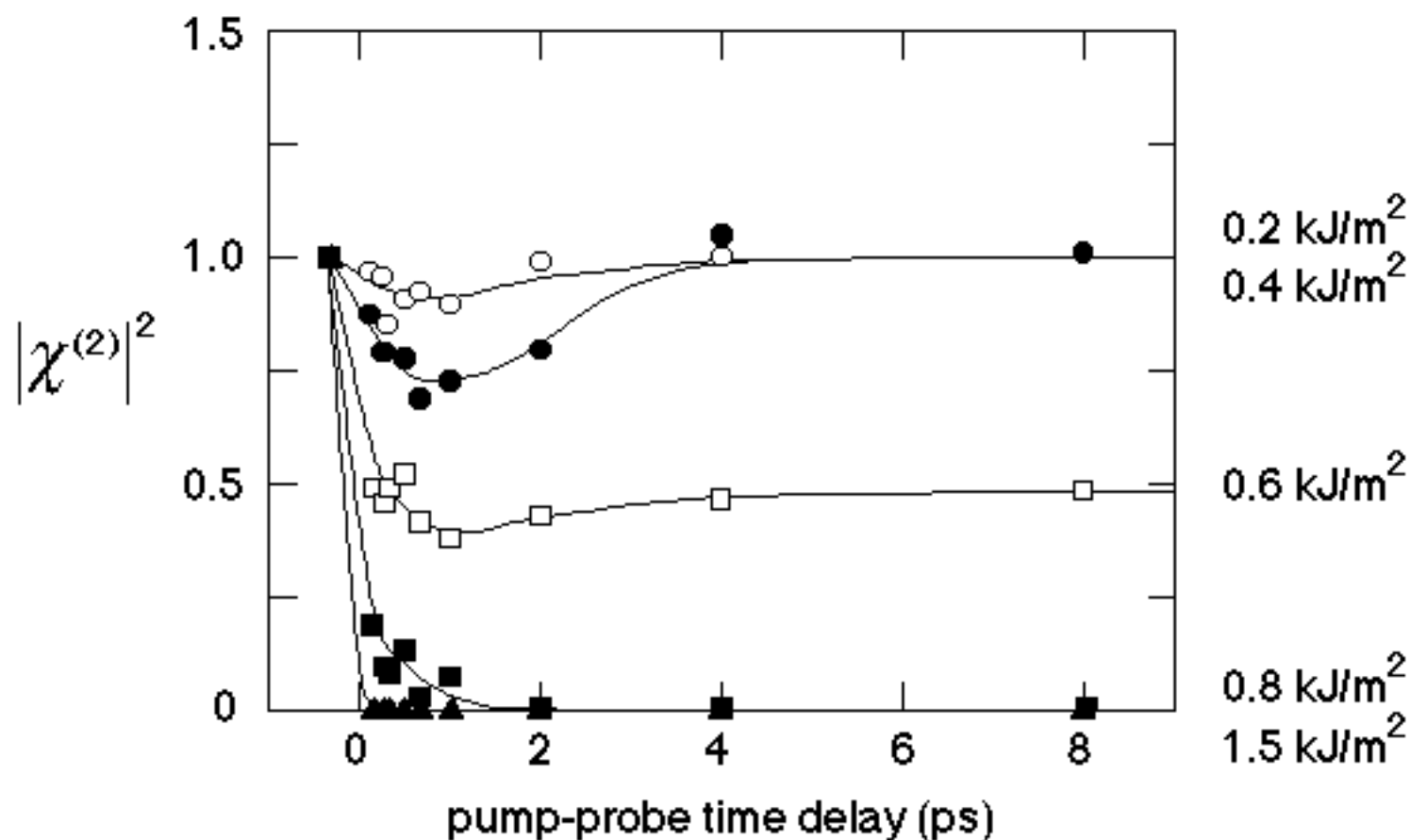

PRELIMINARY RESULTS *Si*

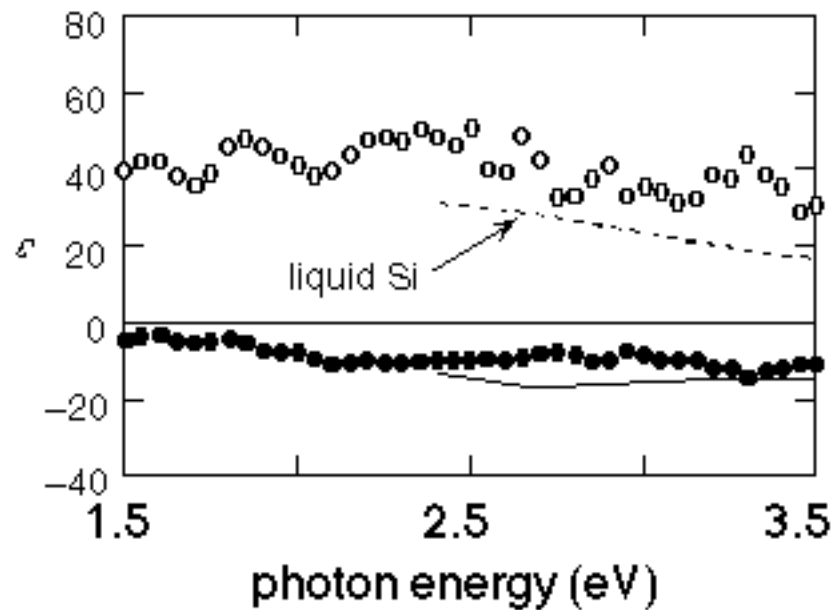
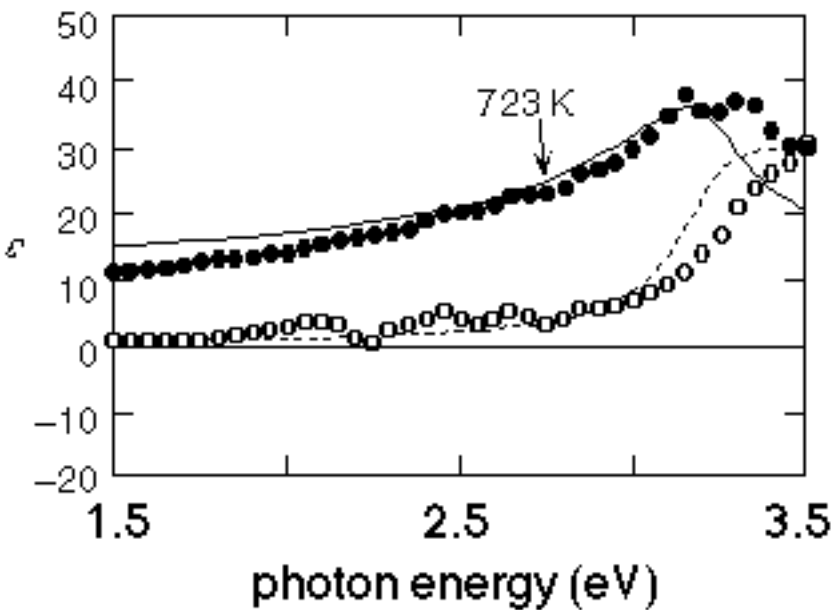

LOW FLUENCE DATA

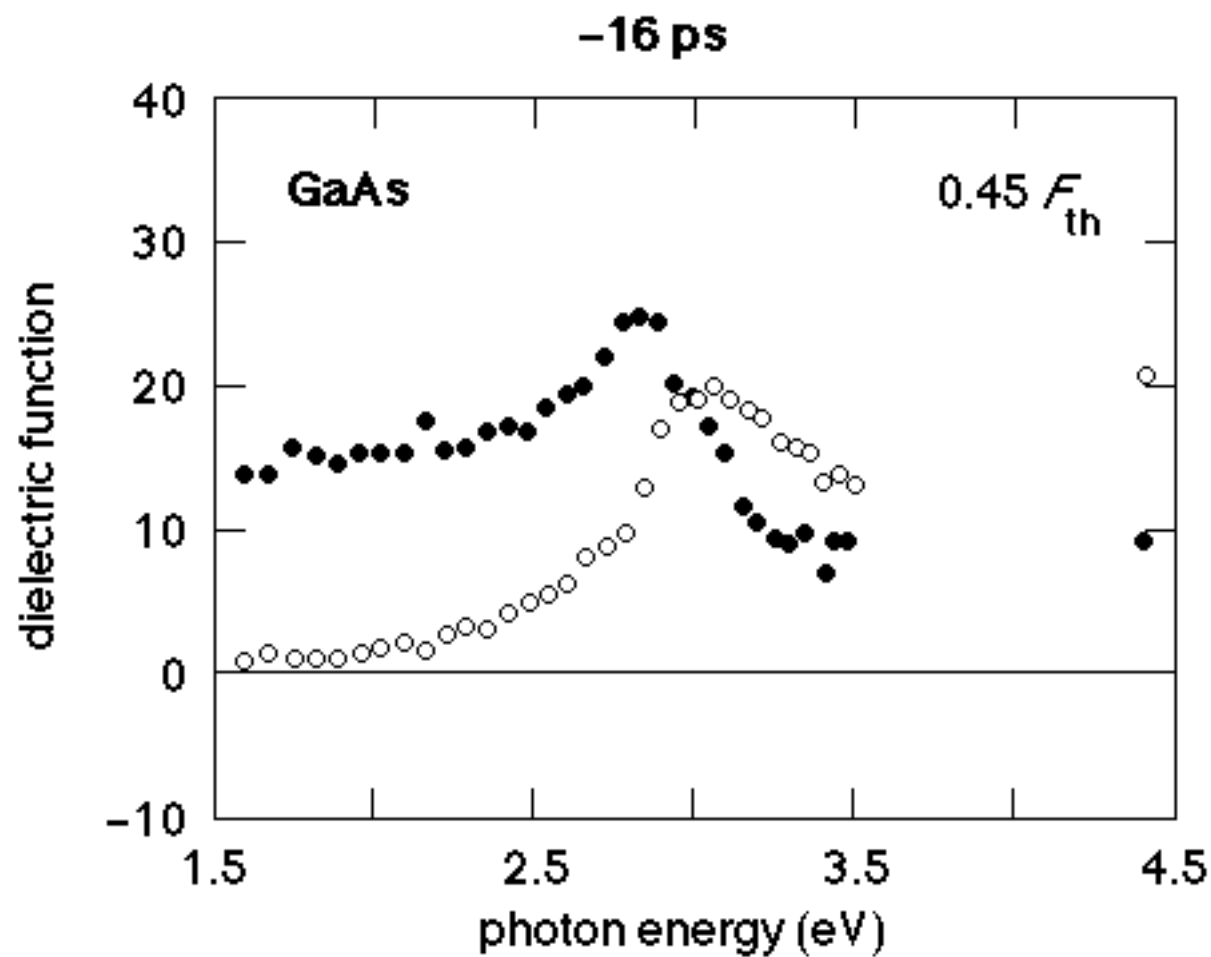

LOW FLUENCE DATA

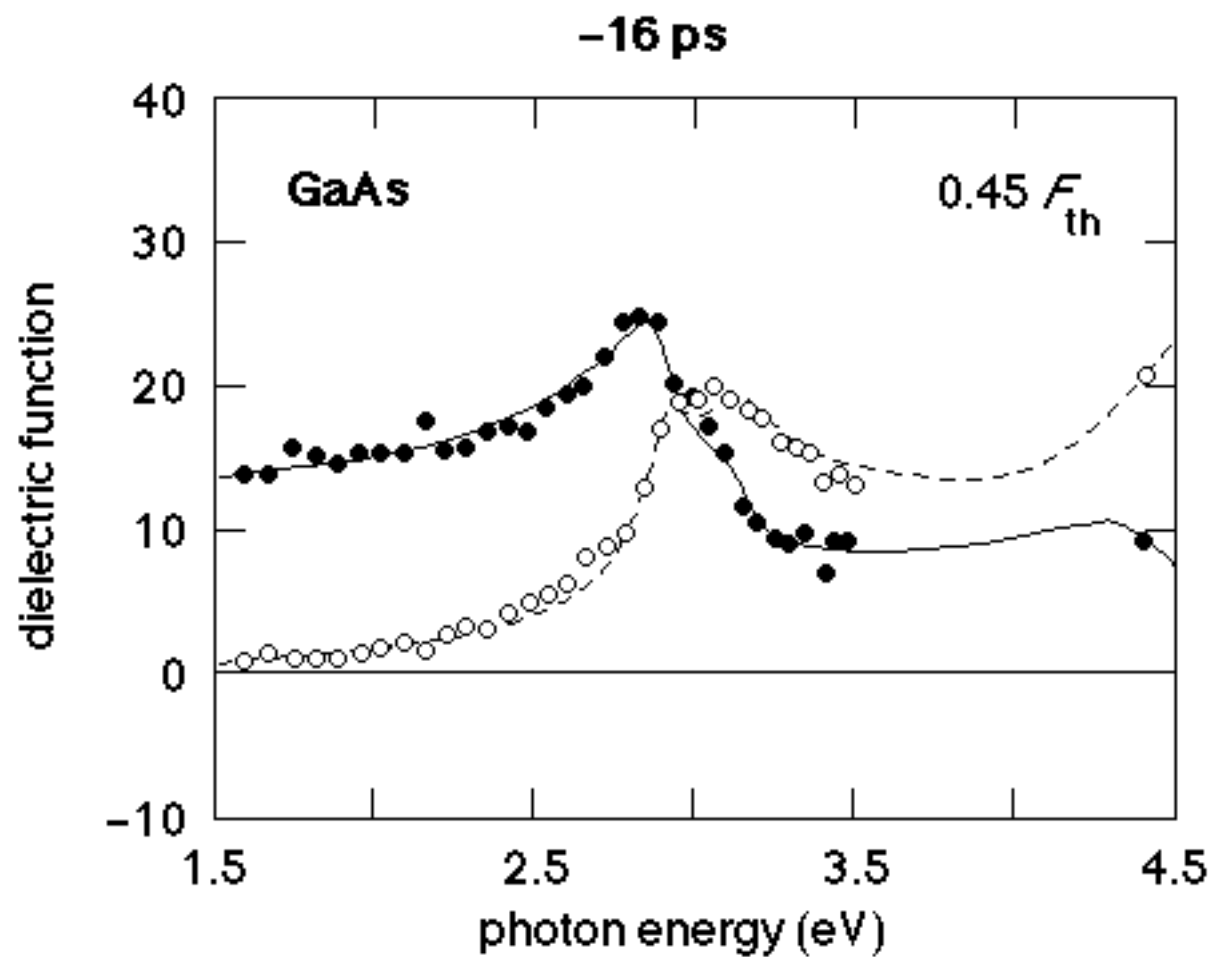

LOW FLUENCE DATA

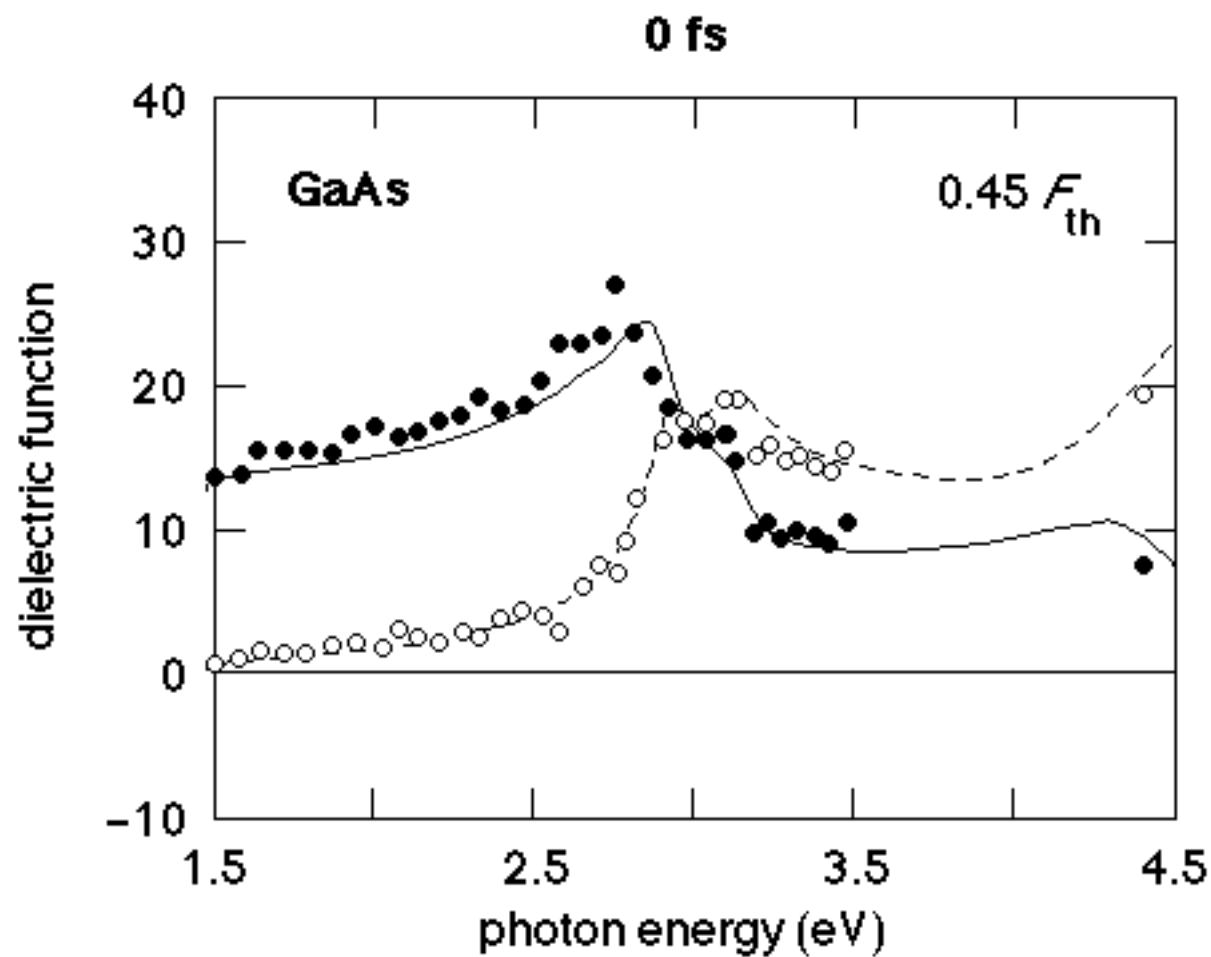

LOW FLUENCE DATA

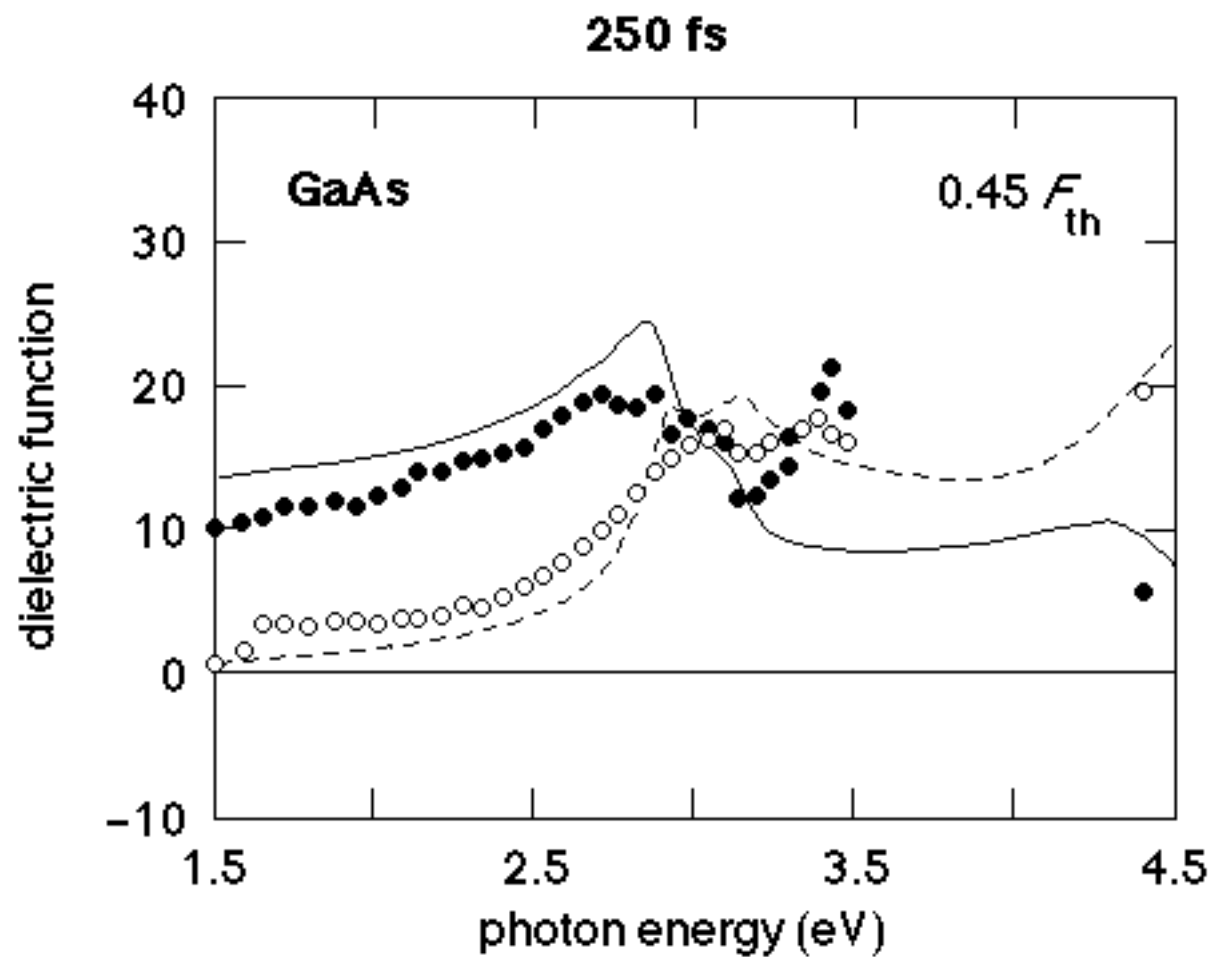

LOW FLUENCE DATA

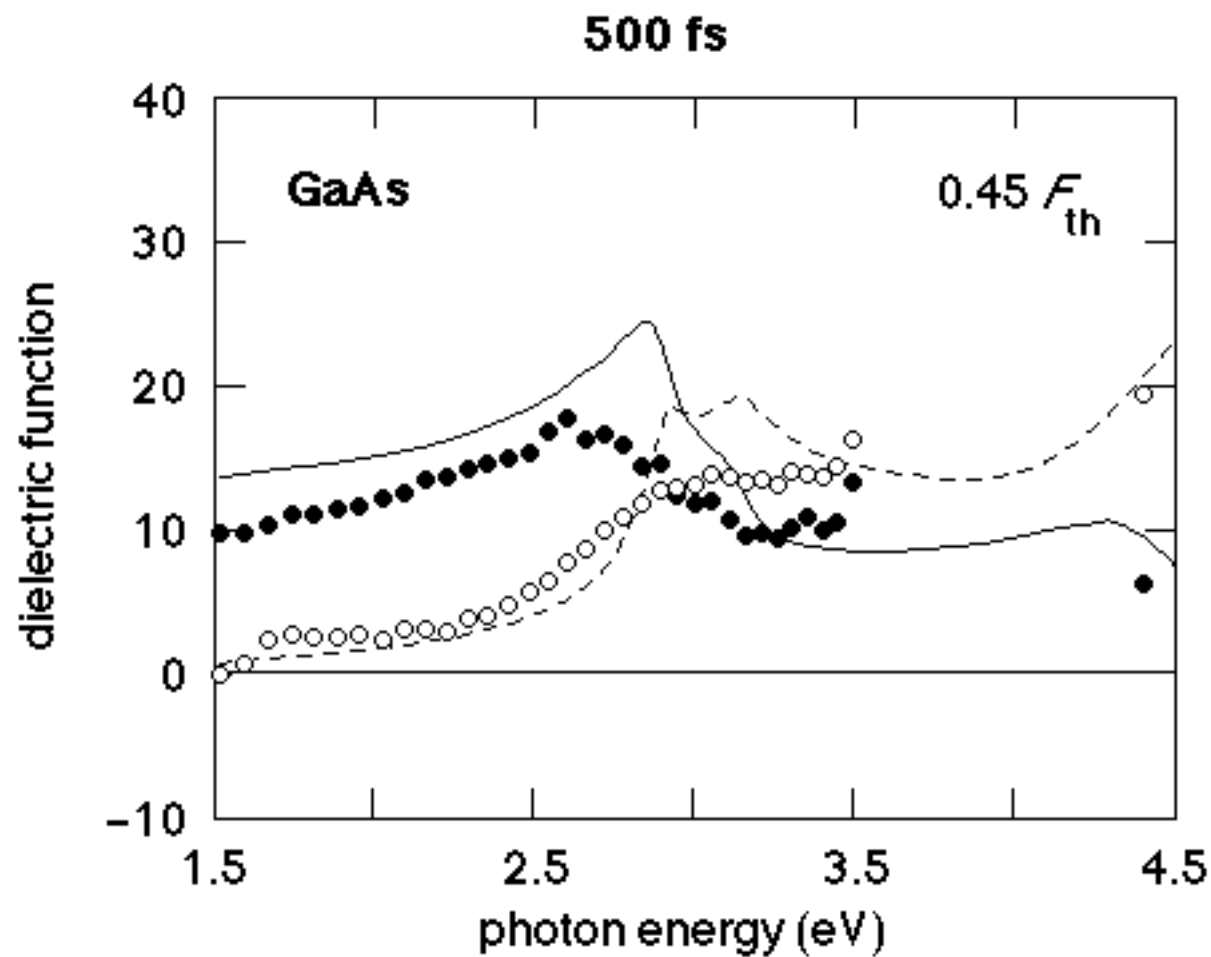

LOW FLUENCE DATA

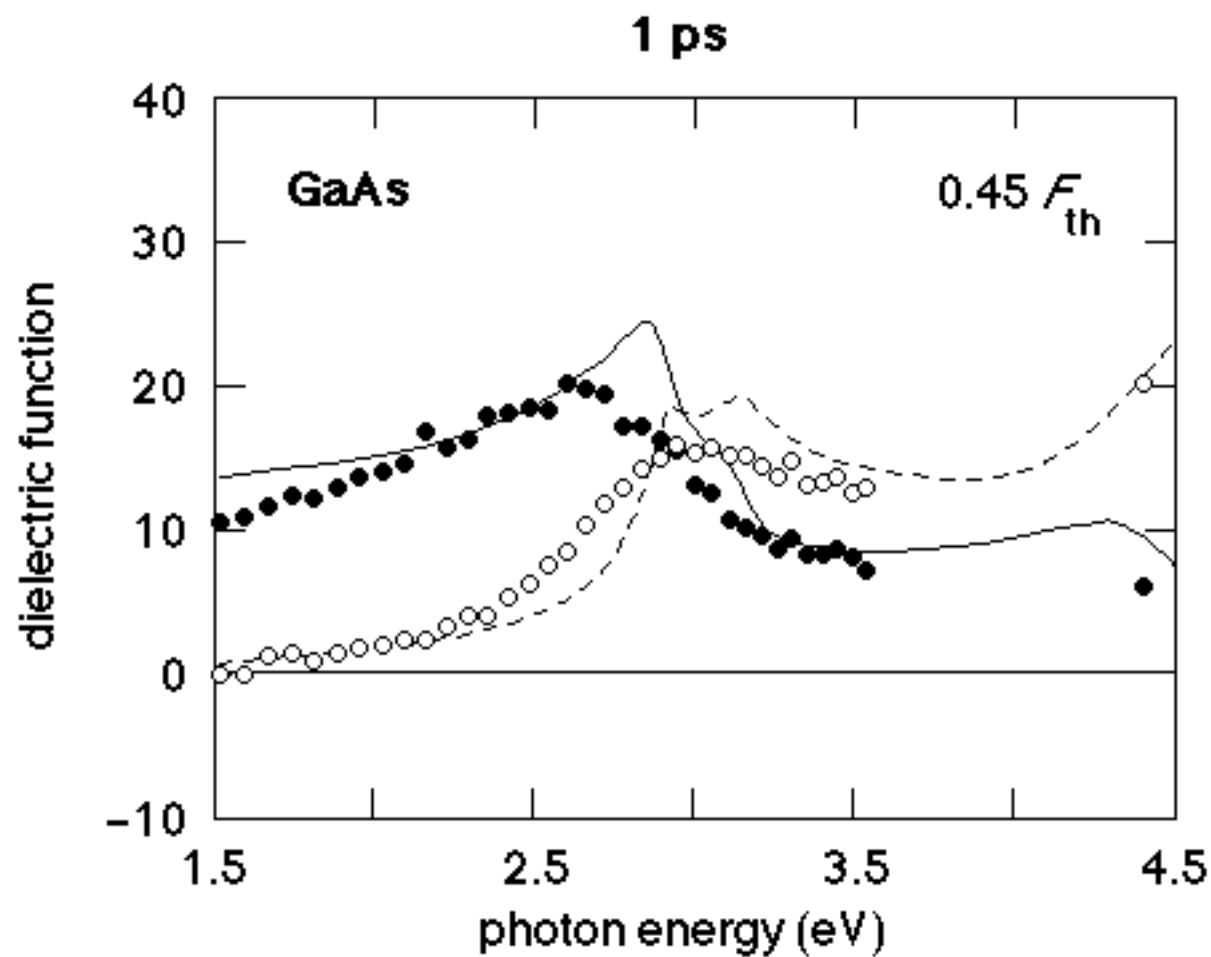

LOW FLUENCE DATA

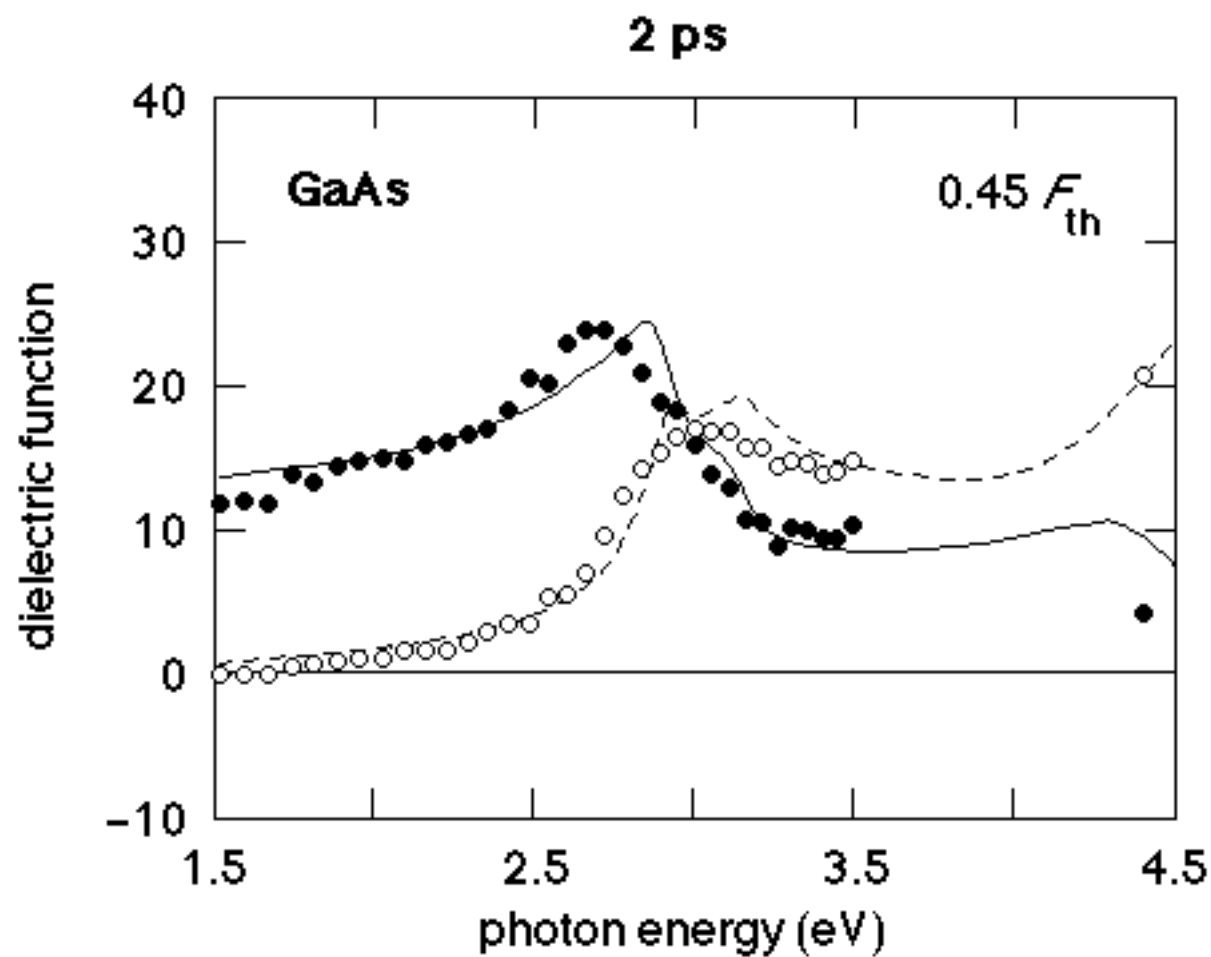

LOW FLUENCE DATA

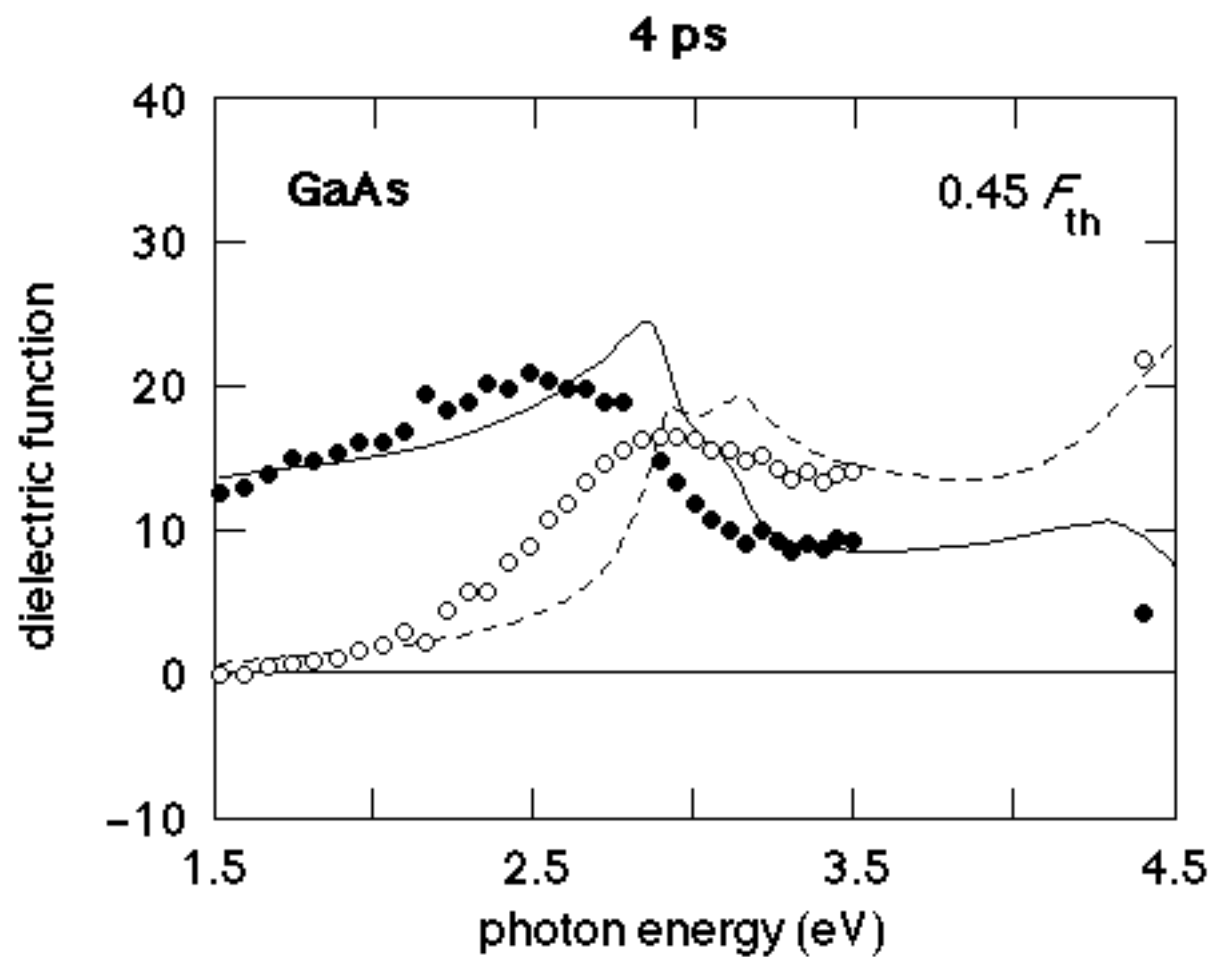

LOW FLUENCE DATA

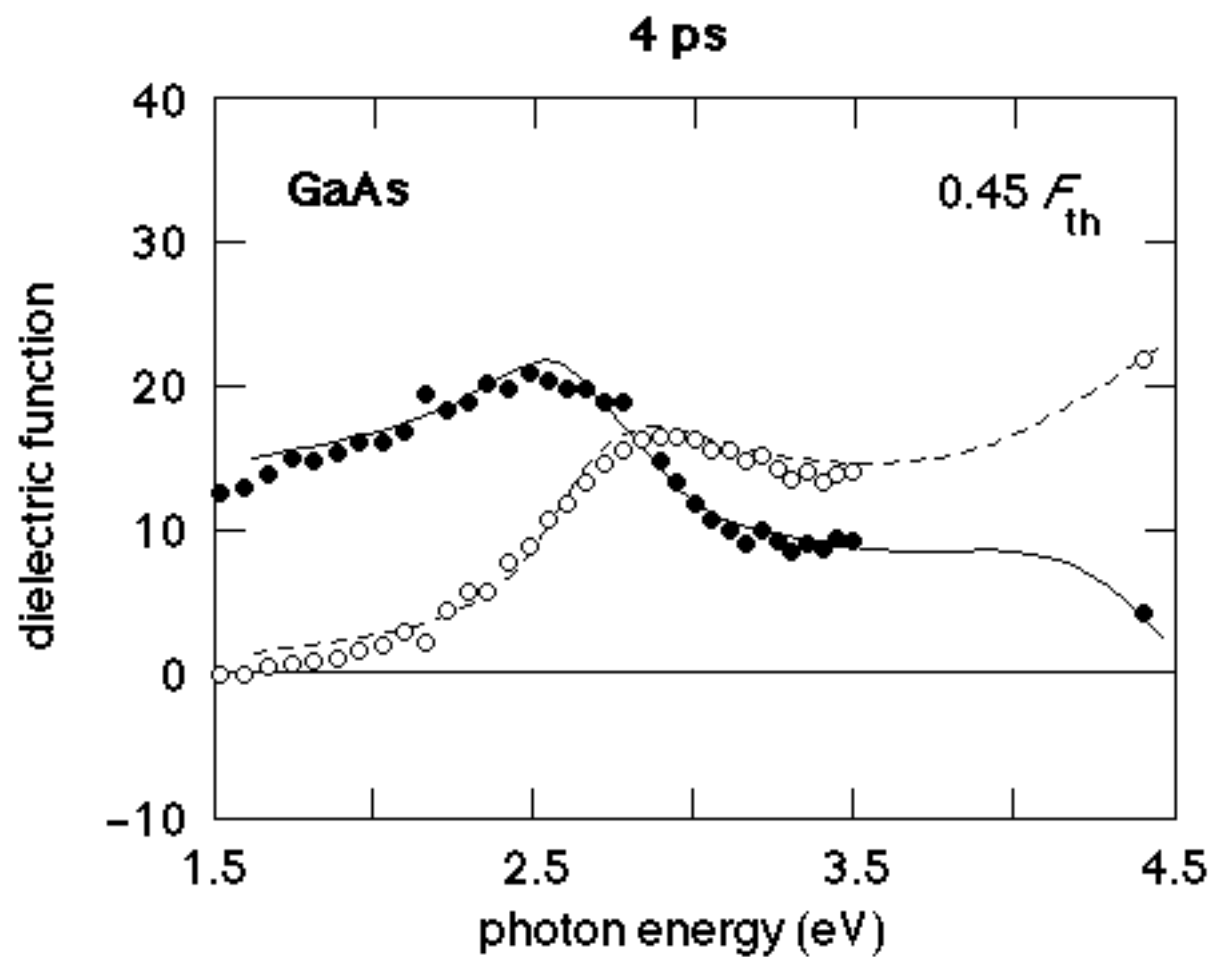

LOW FLUENCE DATA

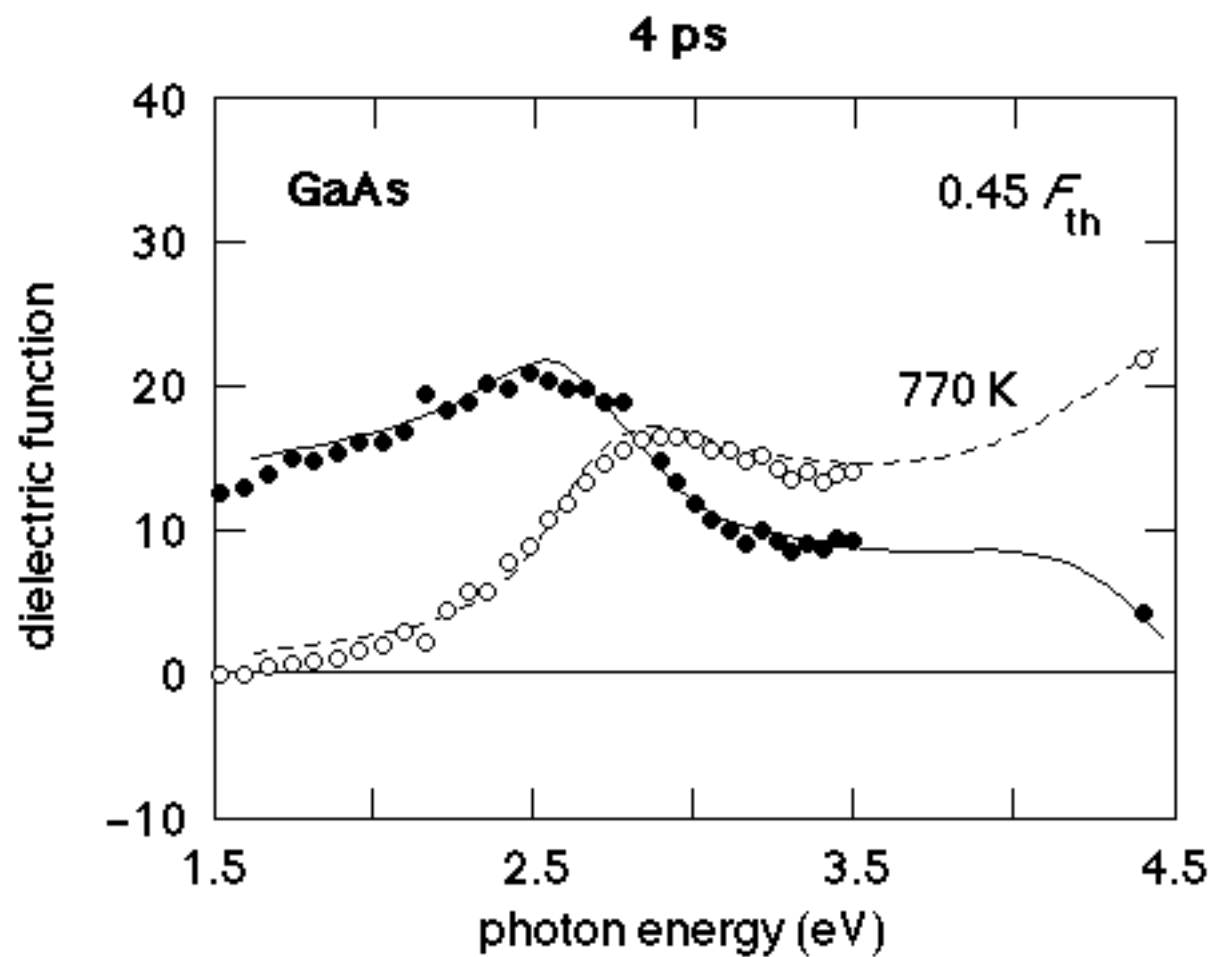

TEMPERATURE

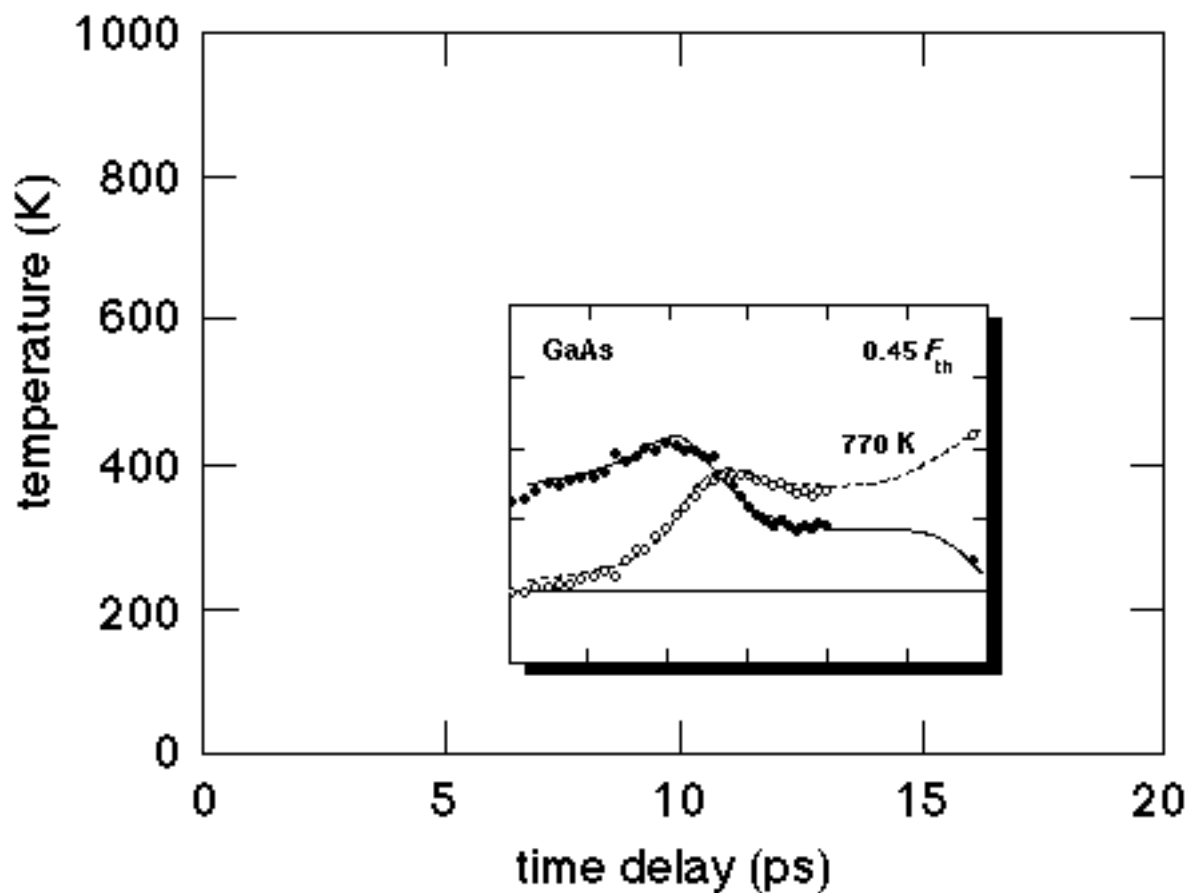

TEMPERATURE

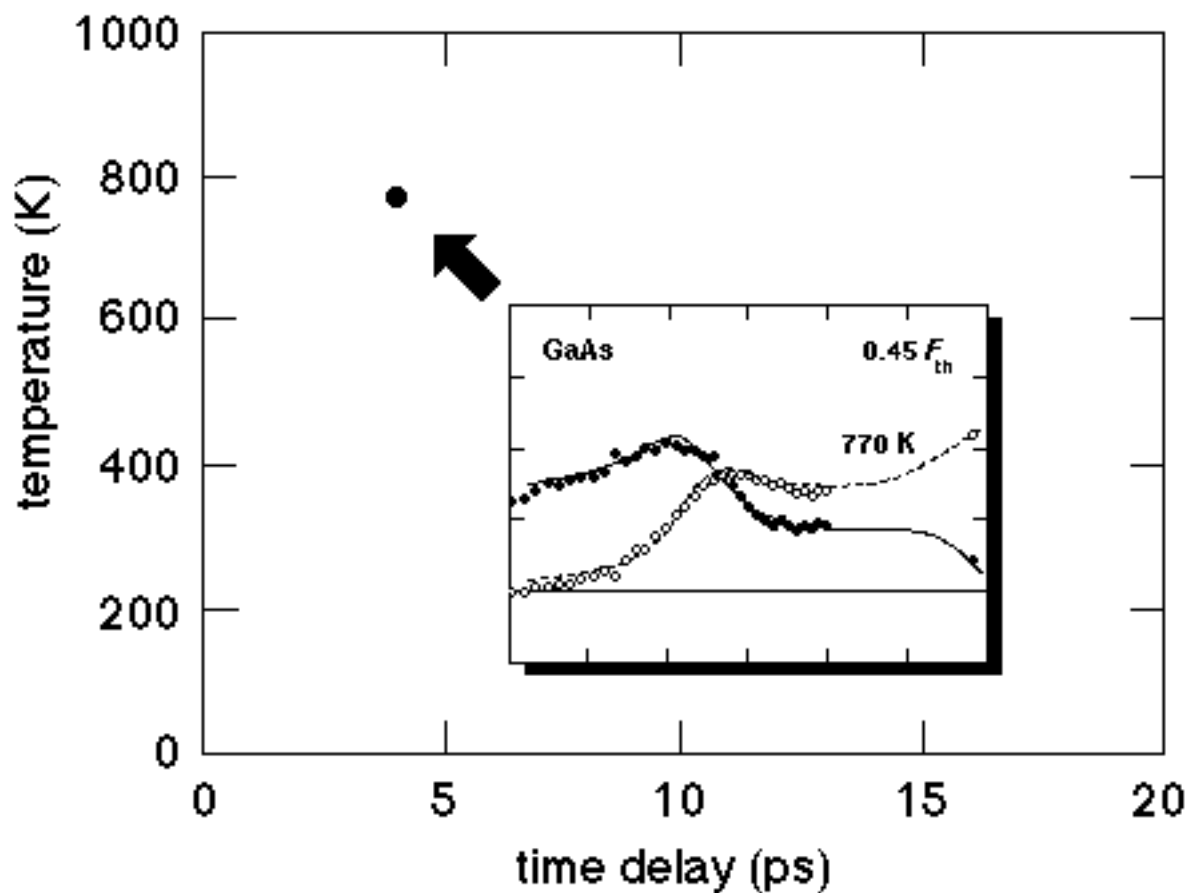

TEMPERATURE

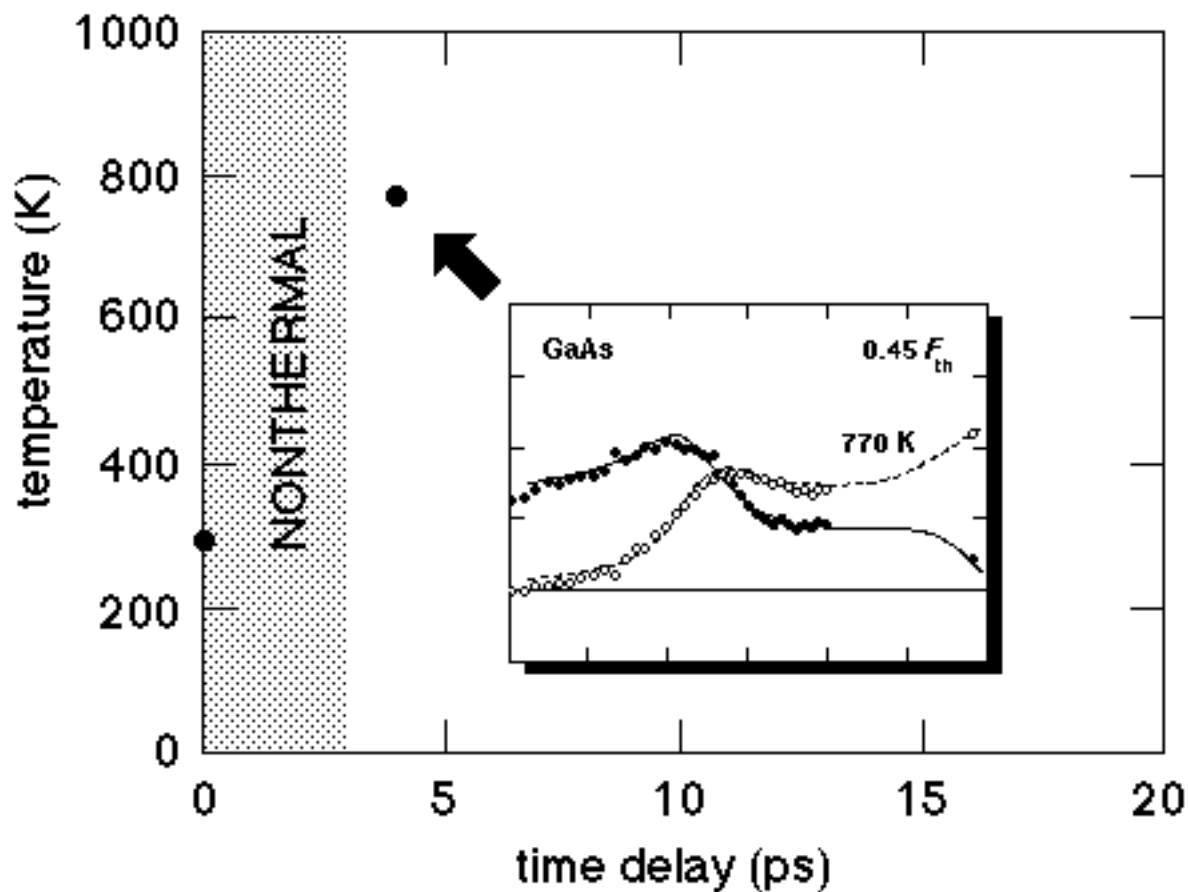

TEMPERATURE

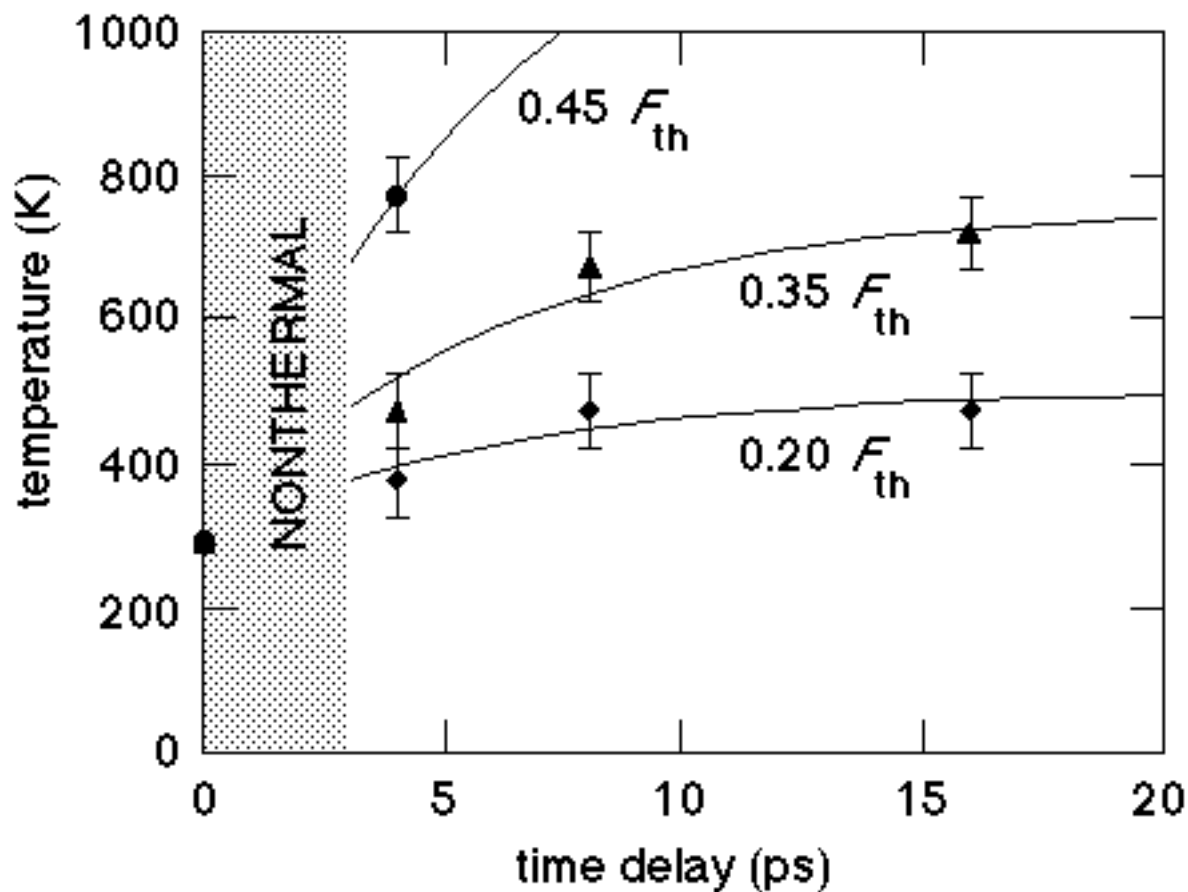

MEDIUM FLUENCE DATA

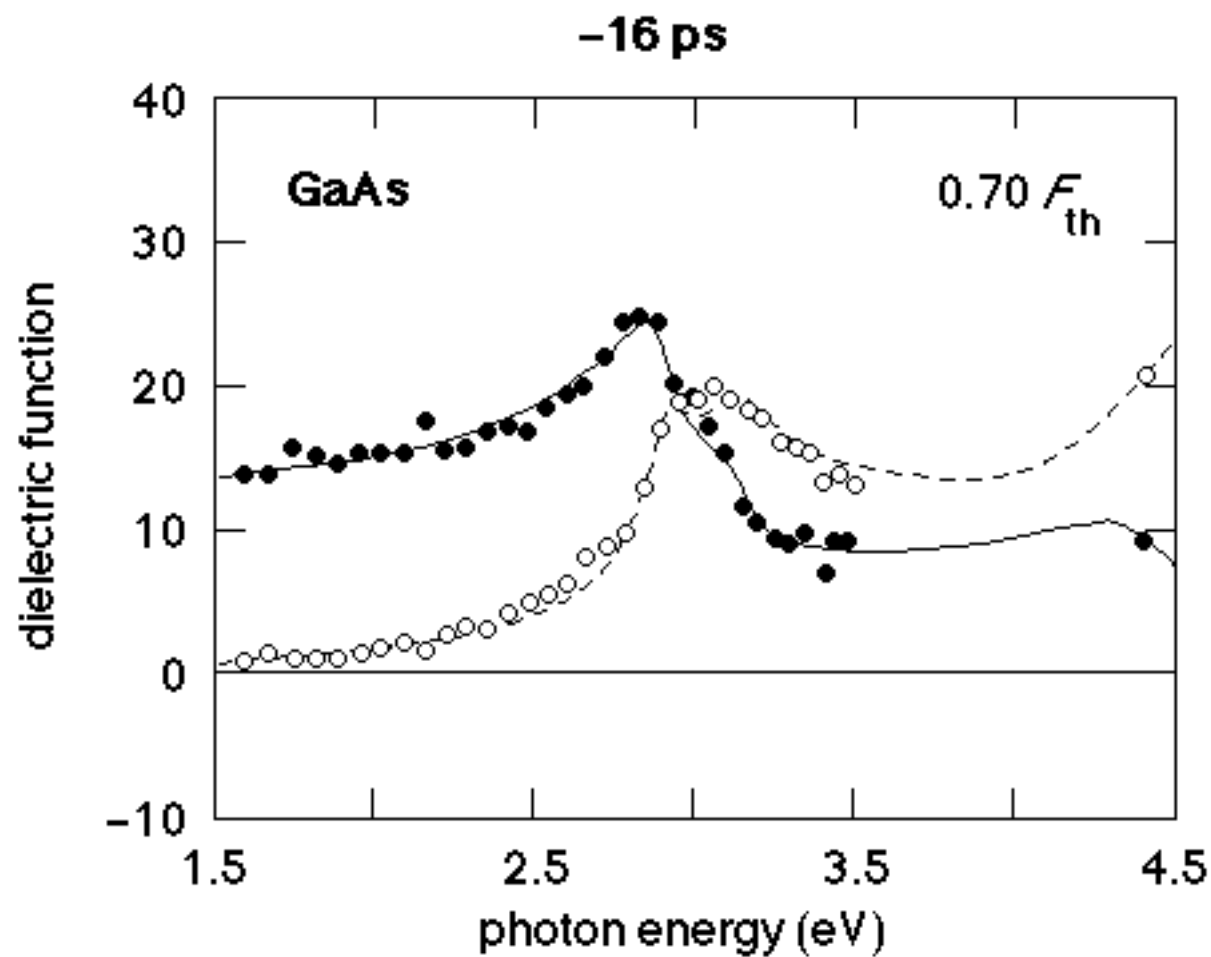

MEDIUM FLUENCE DATA

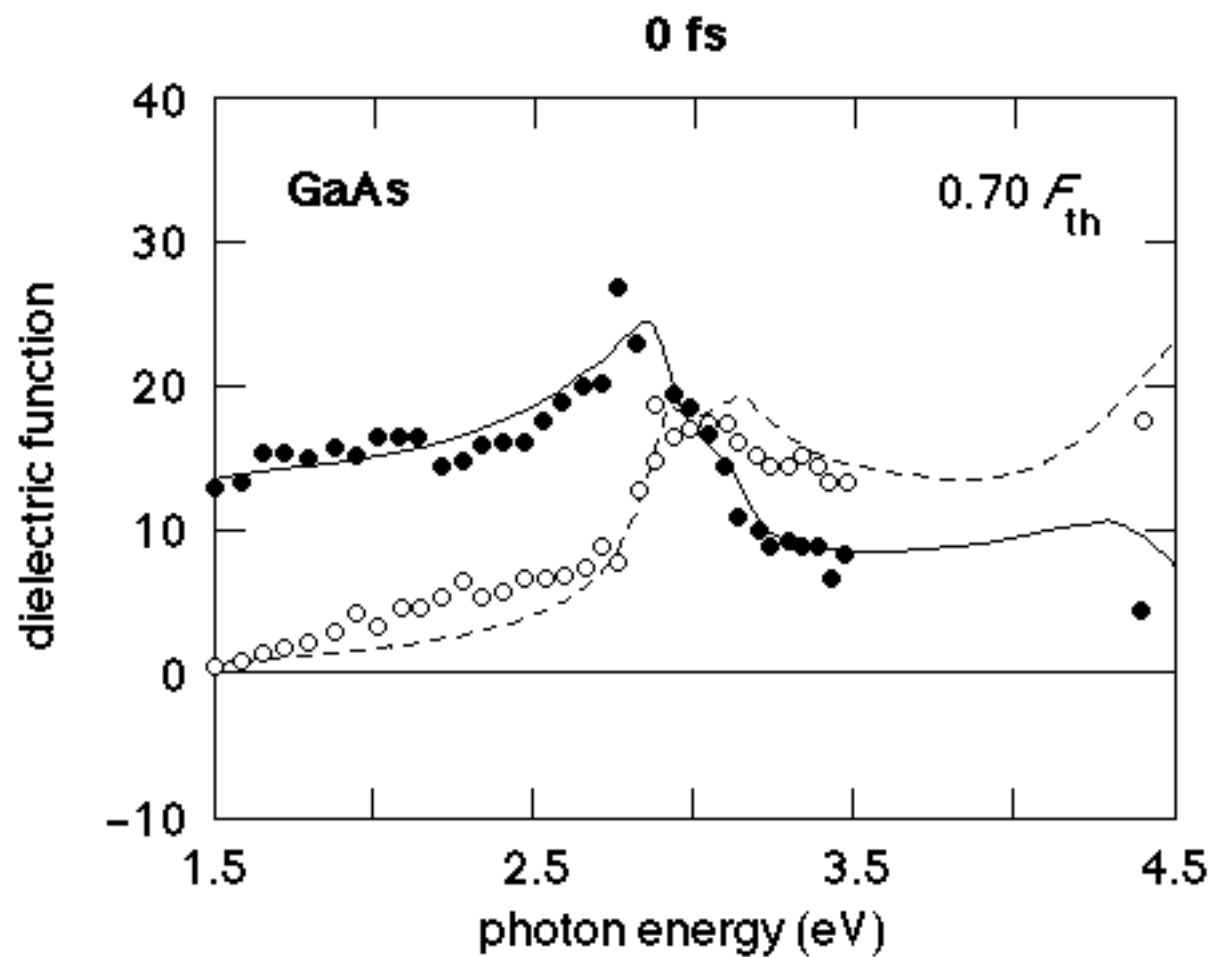

MEDIUM FLUENCE DATA

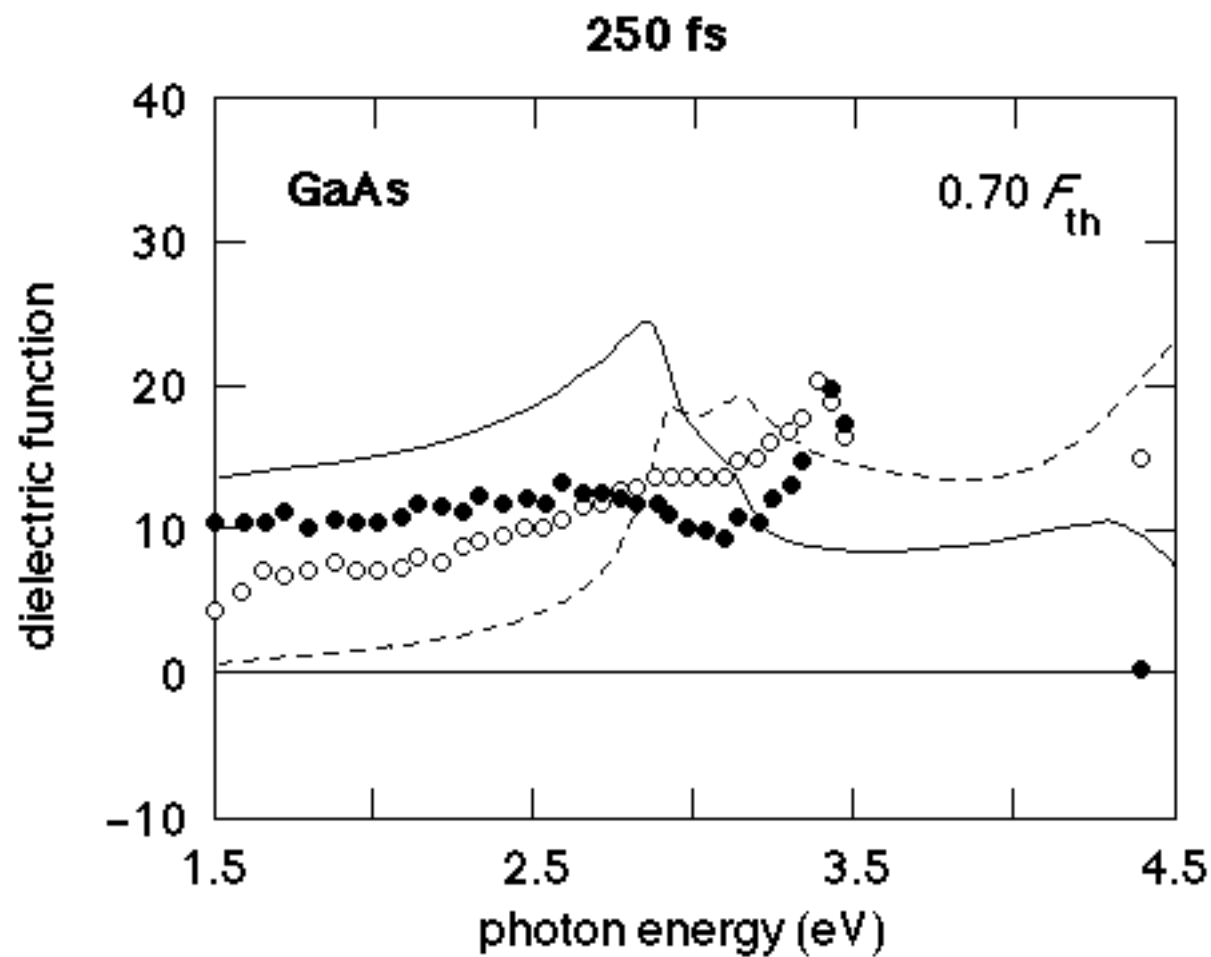

MEDIUM FLUENCE DATA

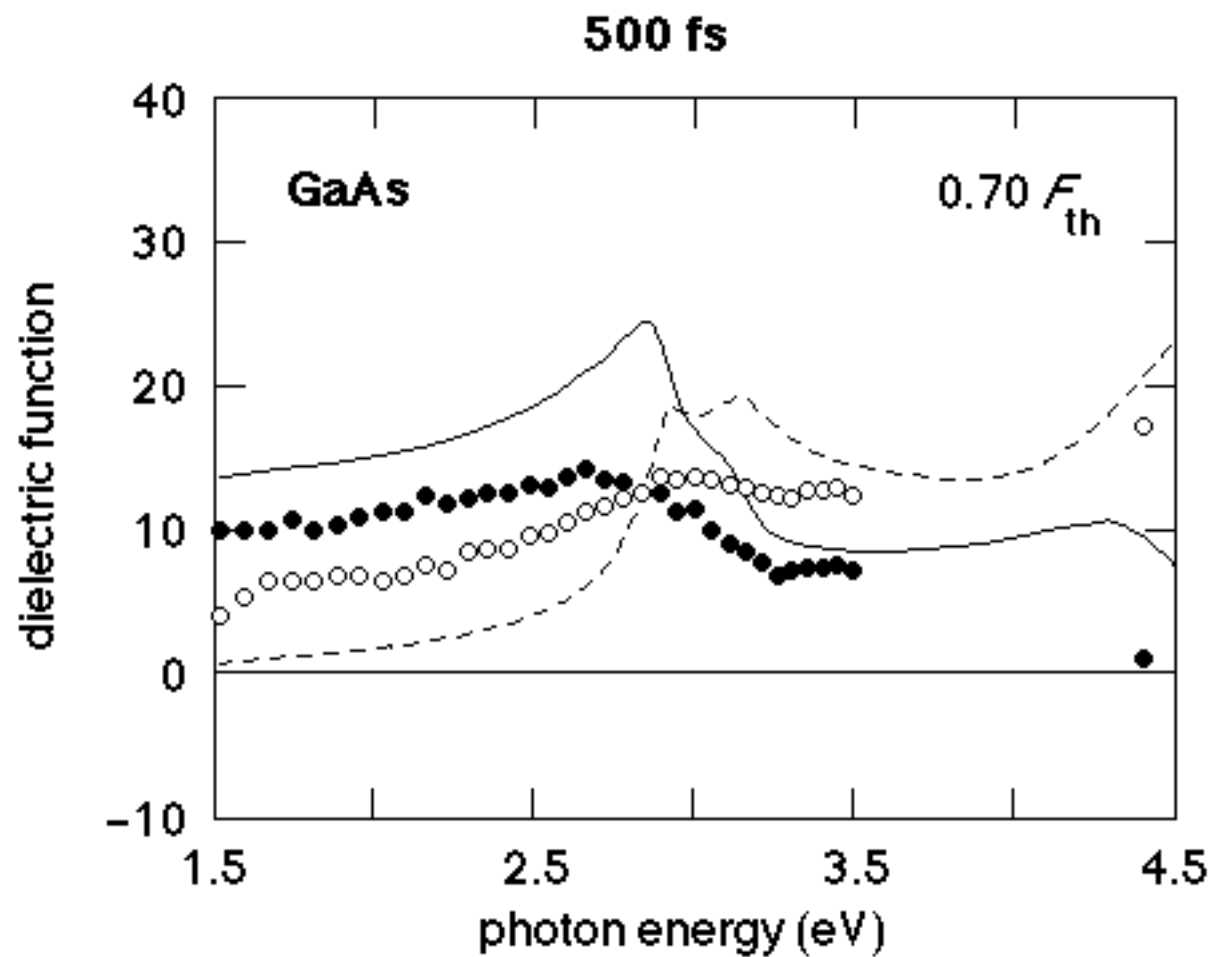

MEDIUM FLUENCE DATA

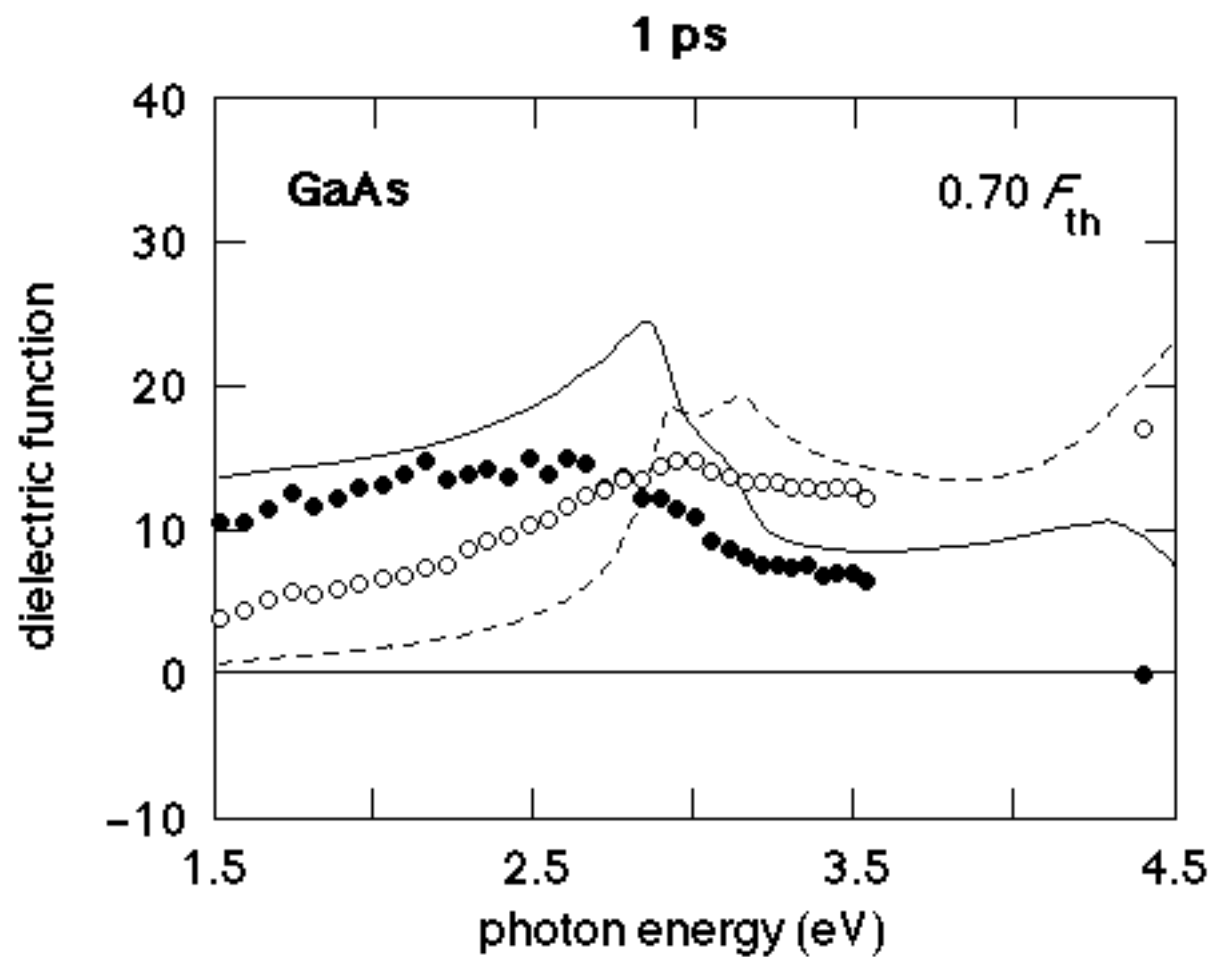

MEDIUM FLUENCE DATA

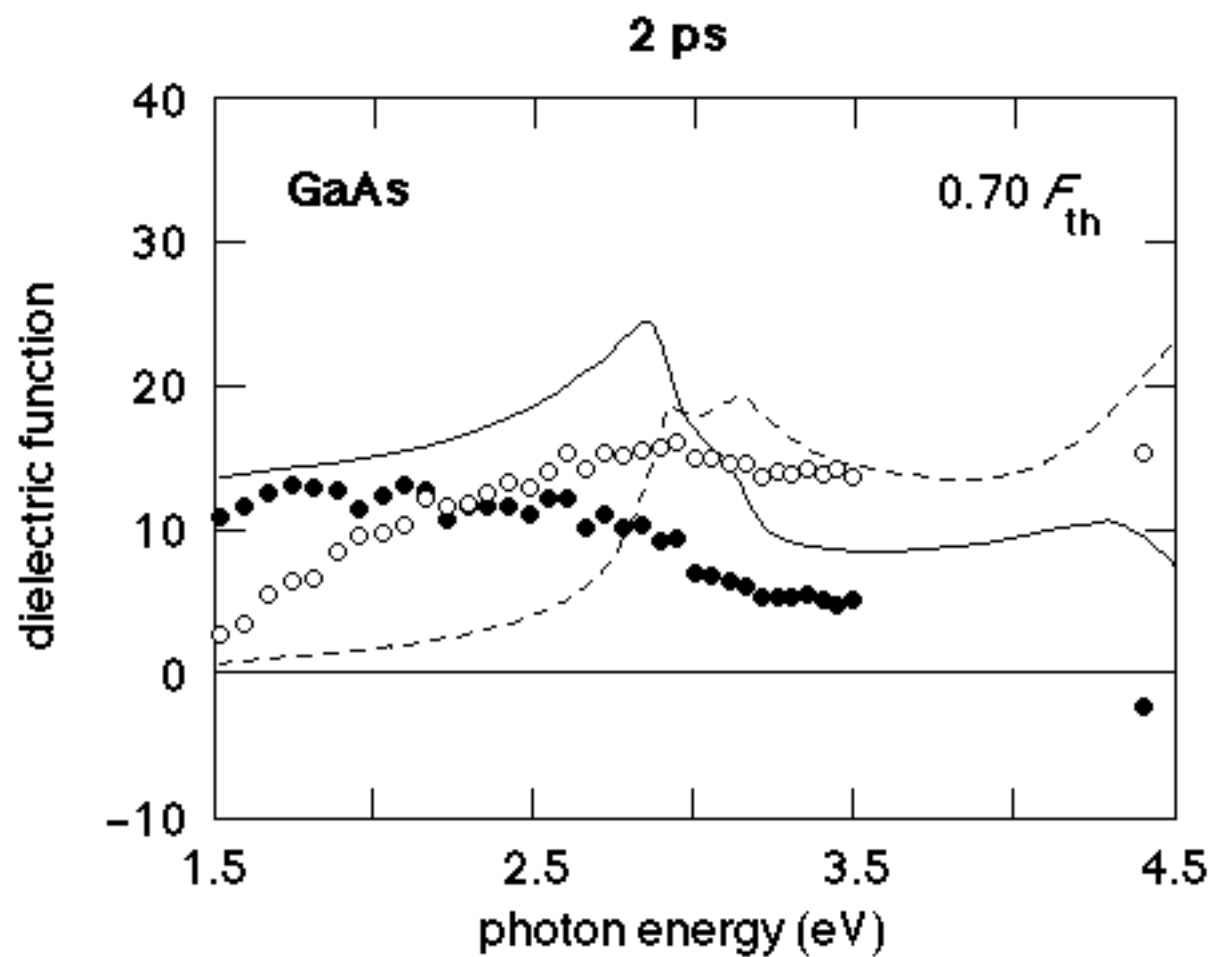

MEDIUM FLUENCE DATA

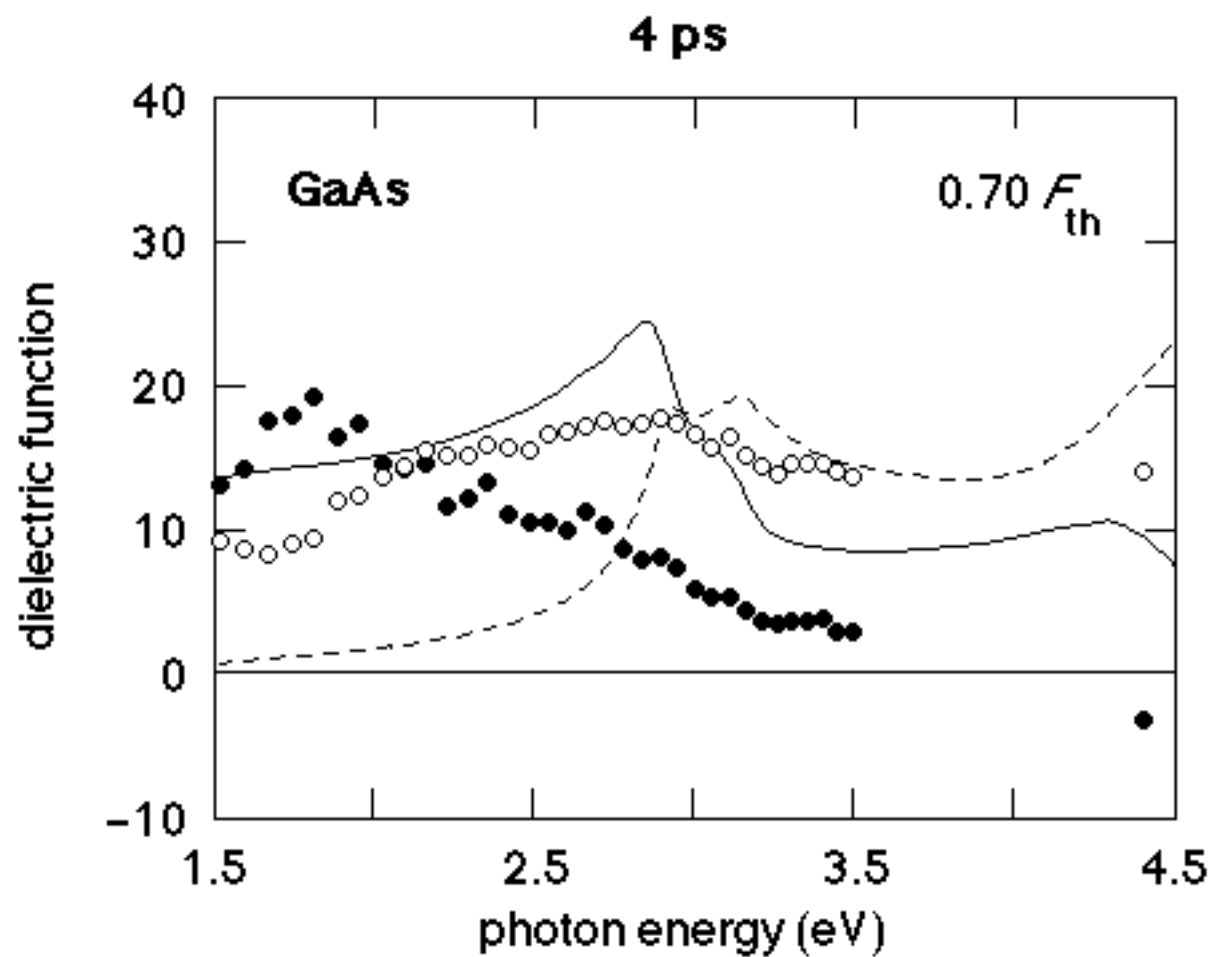

MEDIUM FLUENCE DATA

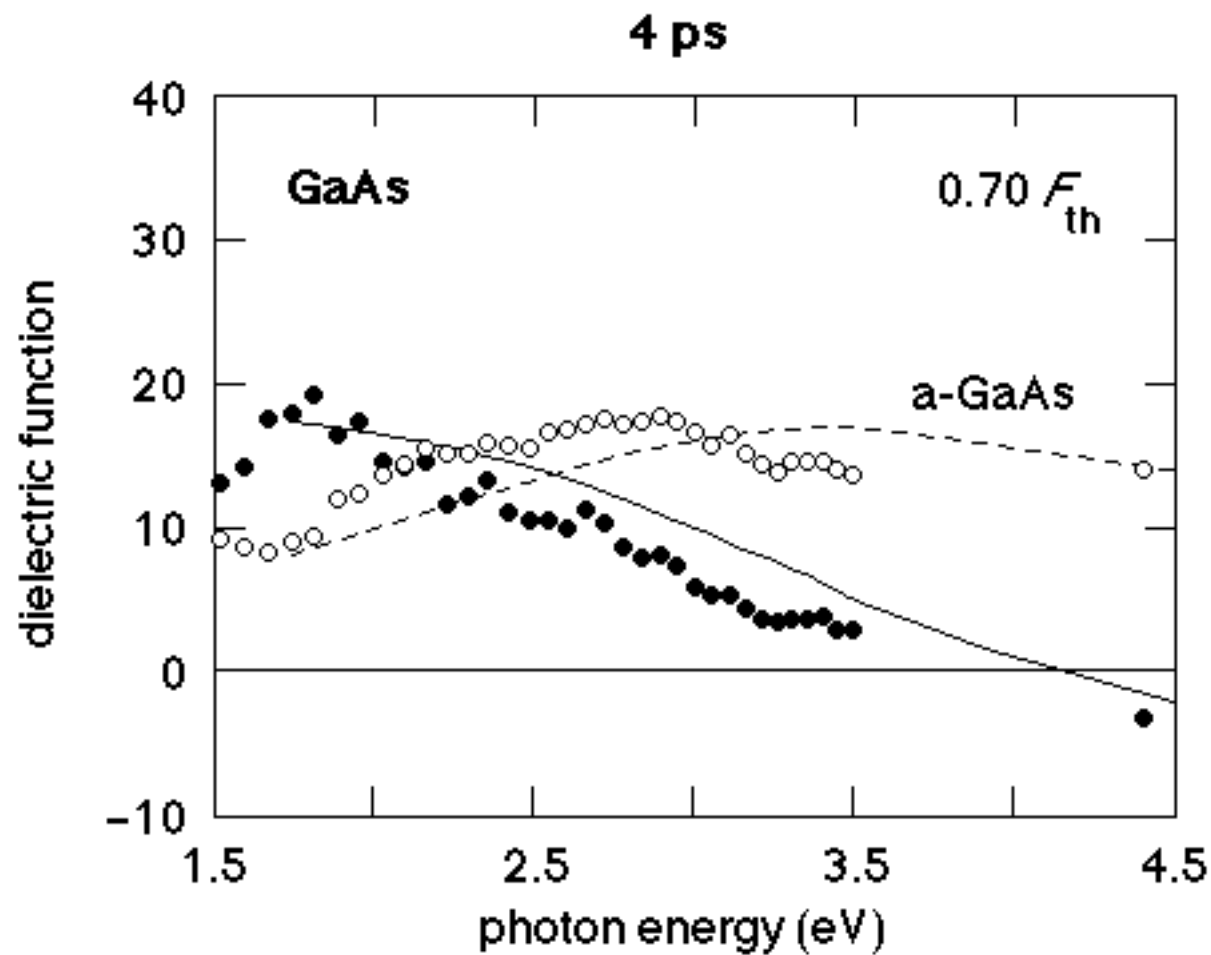

HIGH FLUENCE DATA

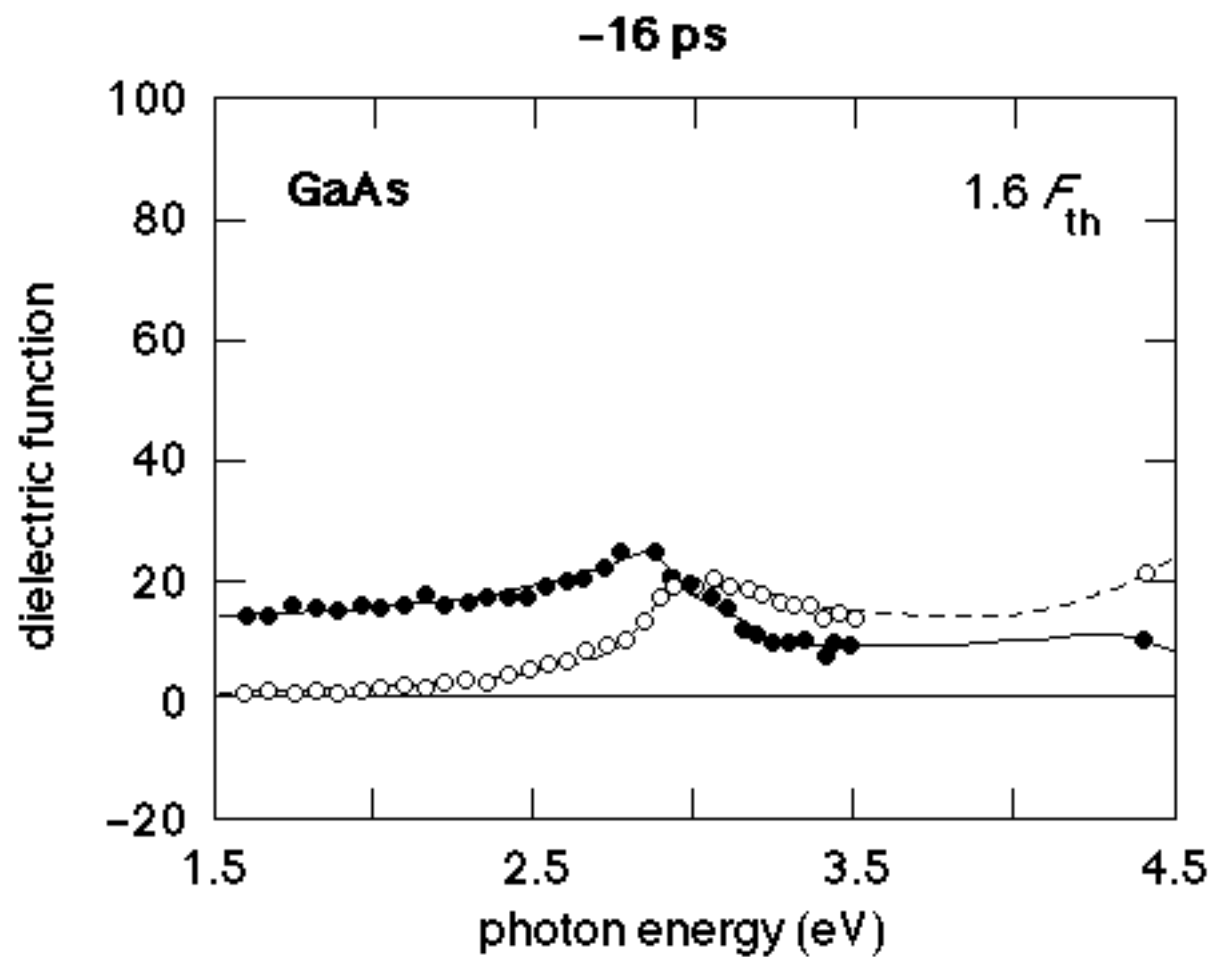

HIGH FLUENCE DATA

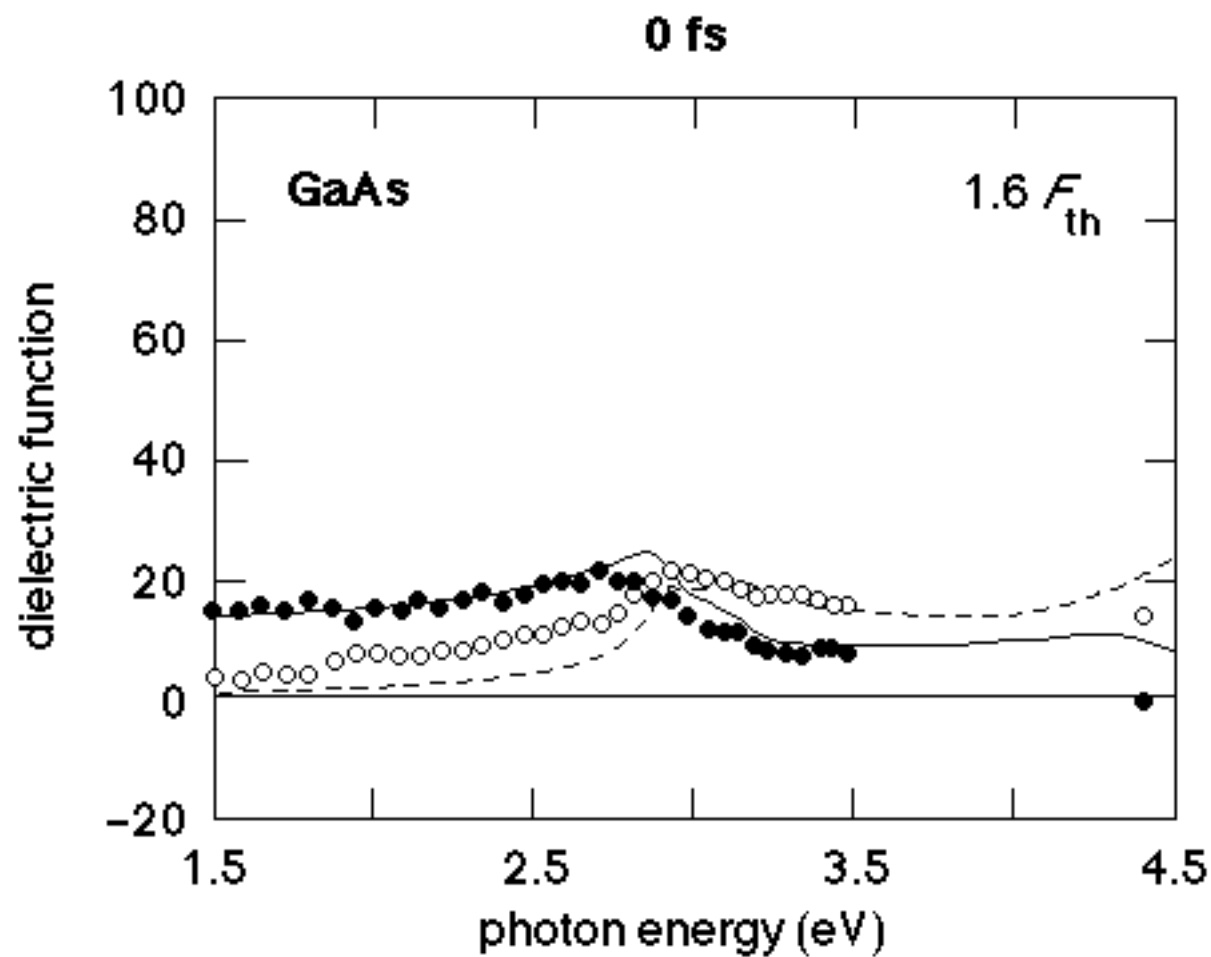

HIGH FLUENCE DATA

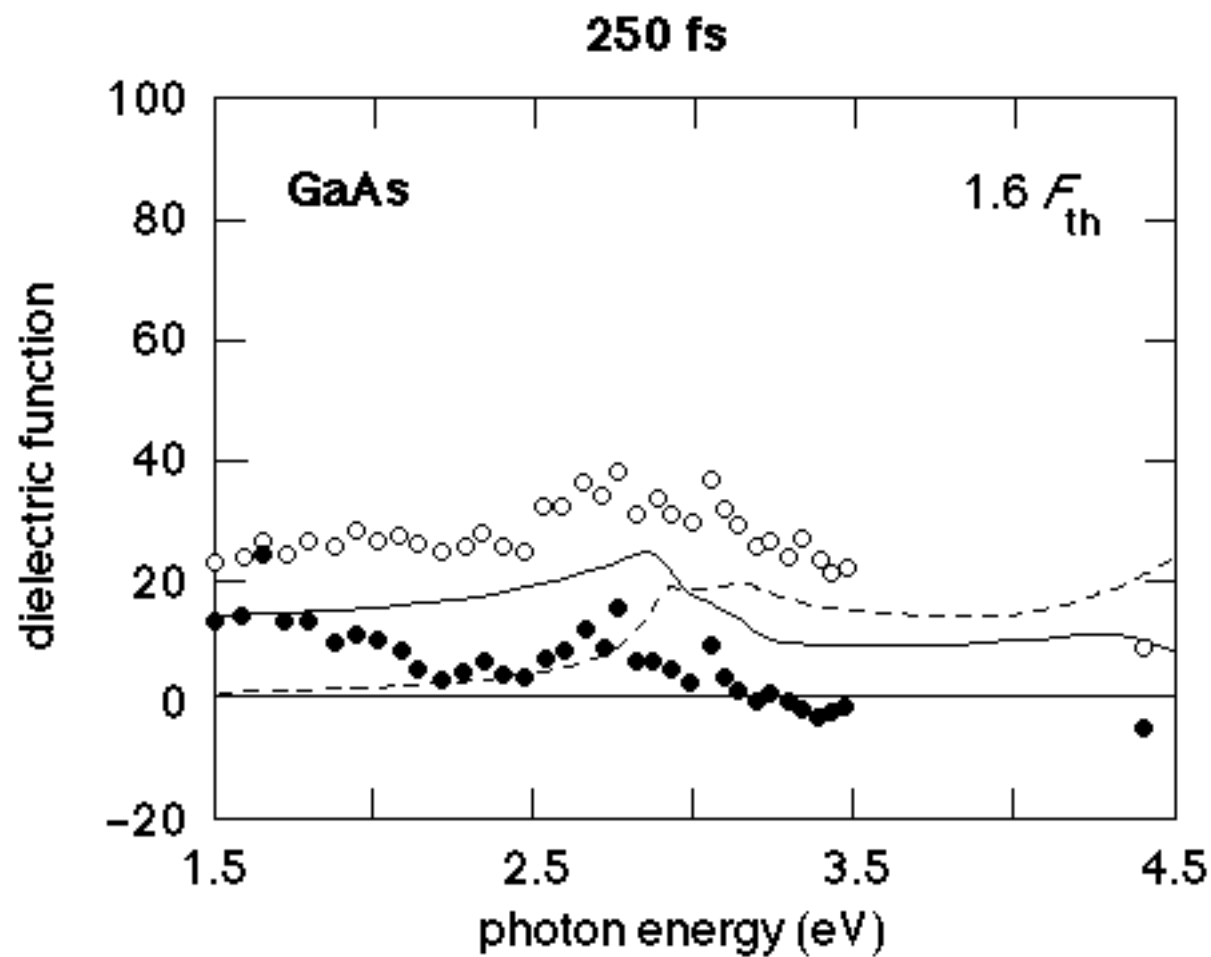

HIGH FLUENCE DATA

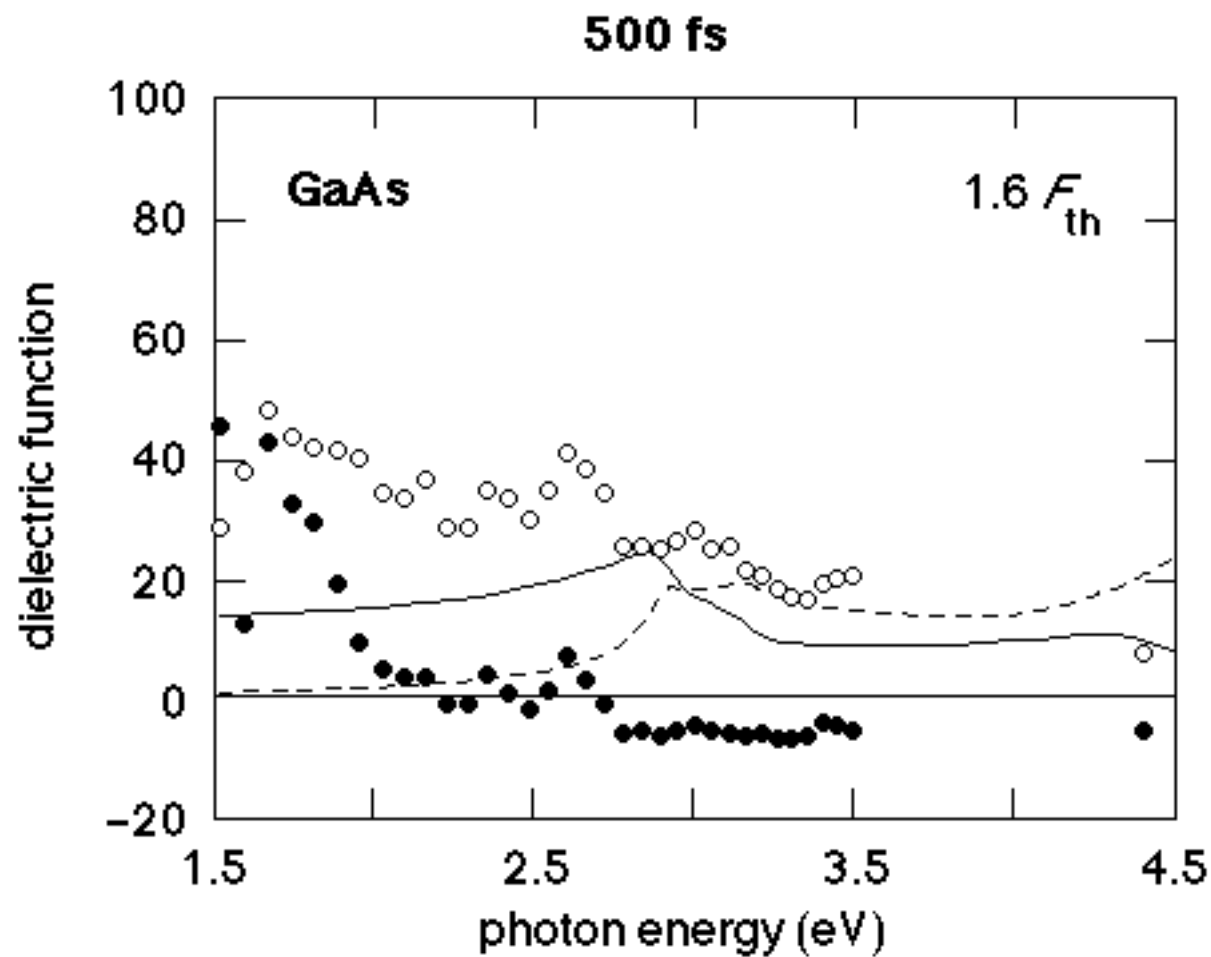

HIGH FLUENCE DATA

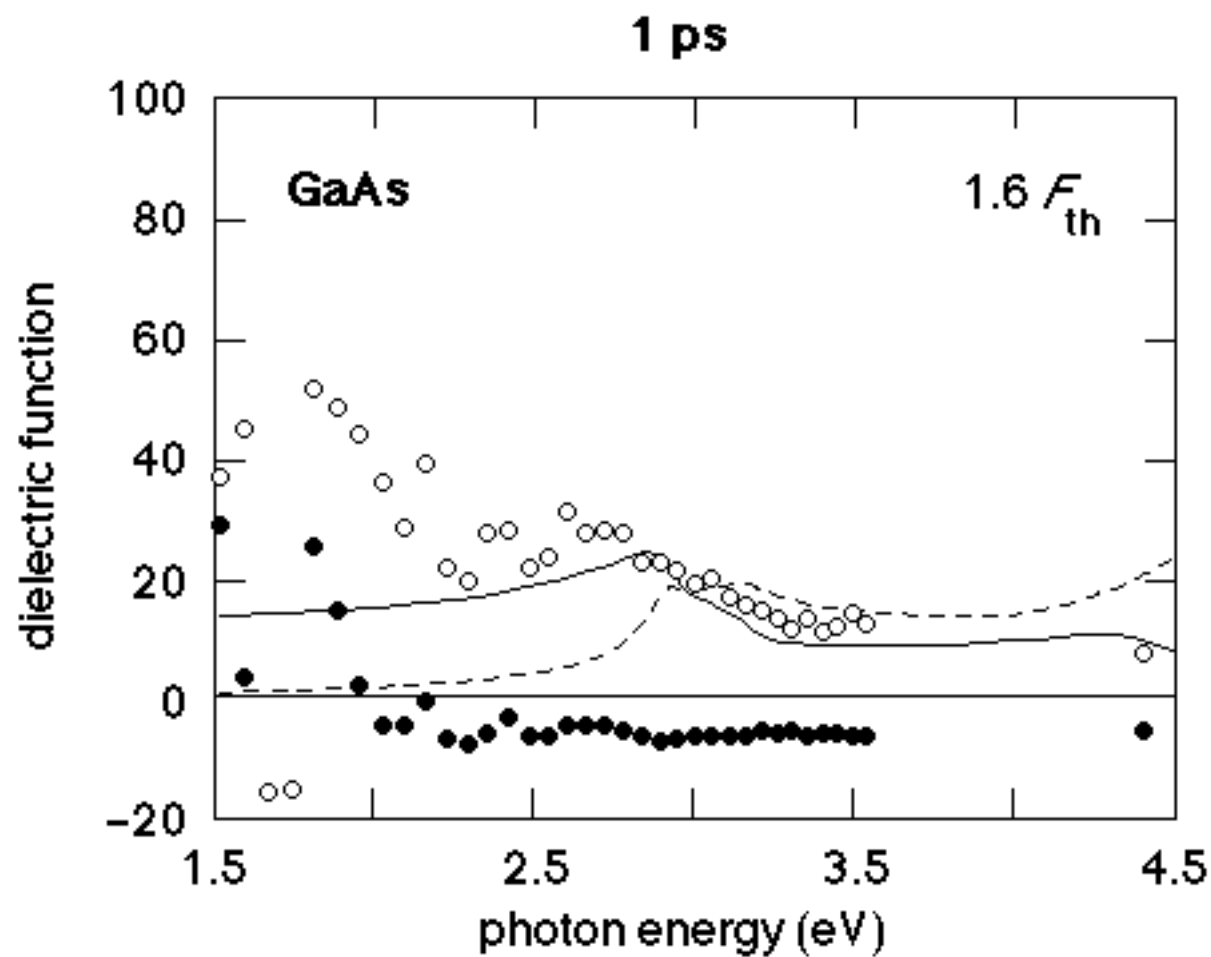

HIGH FLUENCE DATA

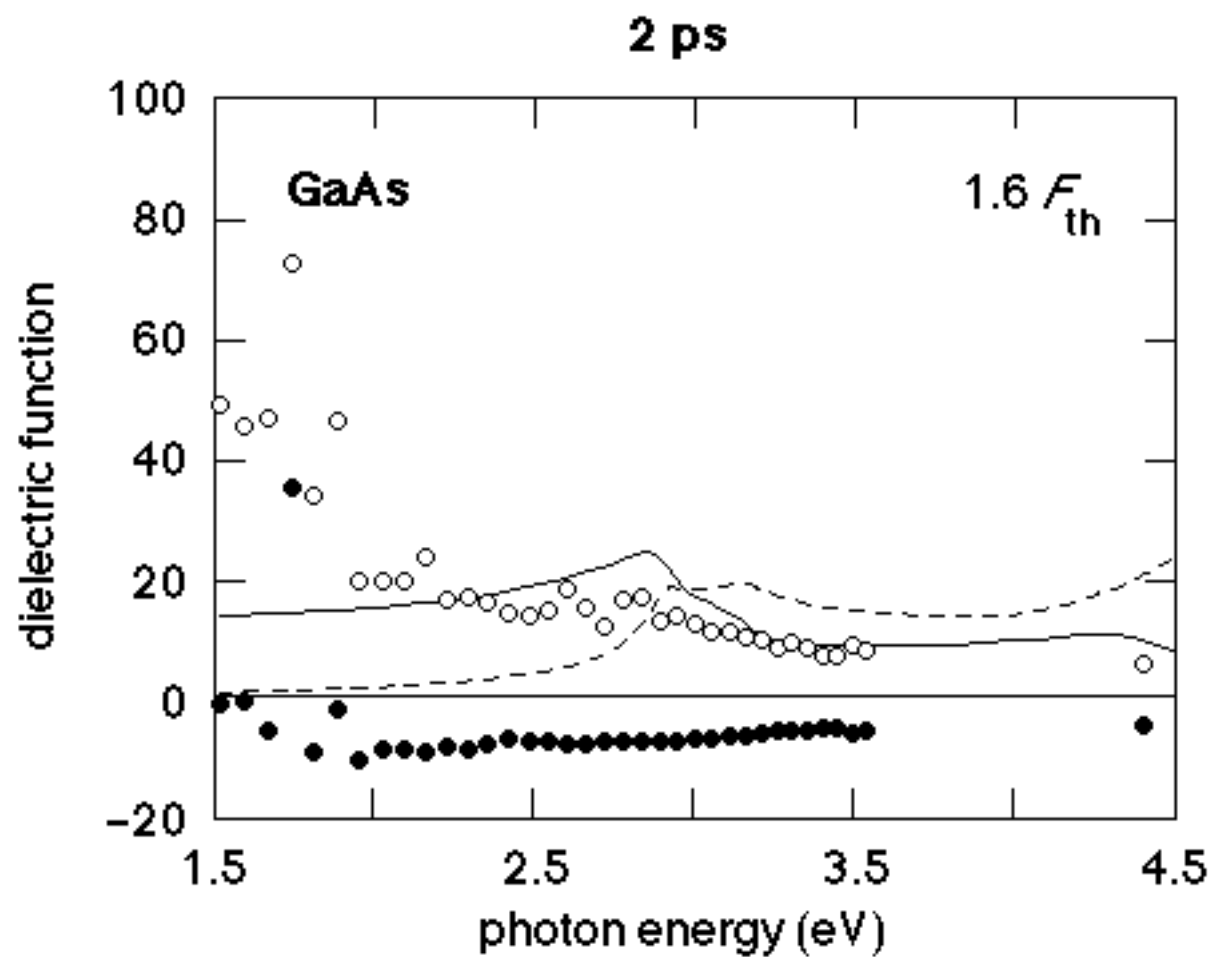

HIGH FLUENCE DATA

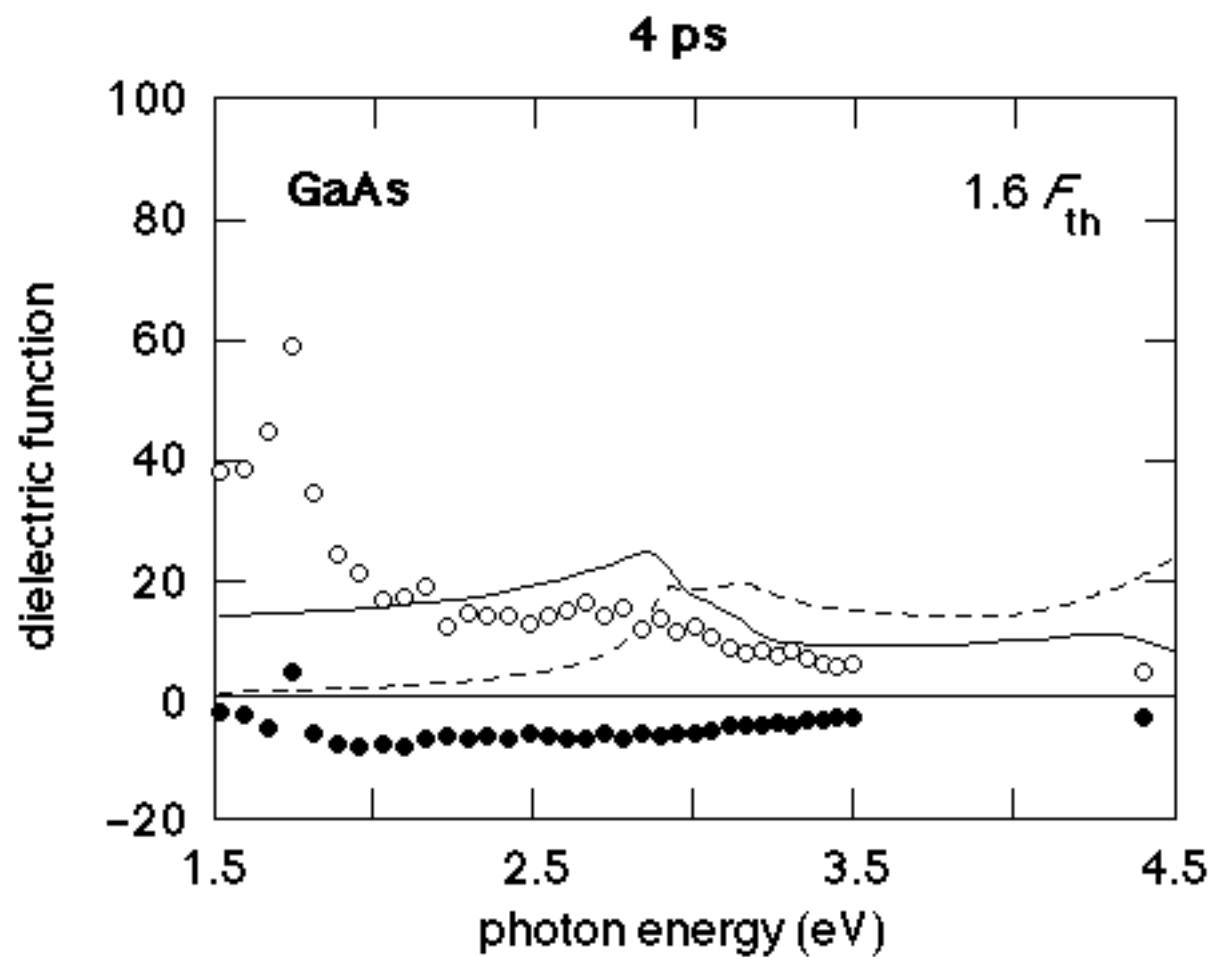

HIGH FLUENCE DATA

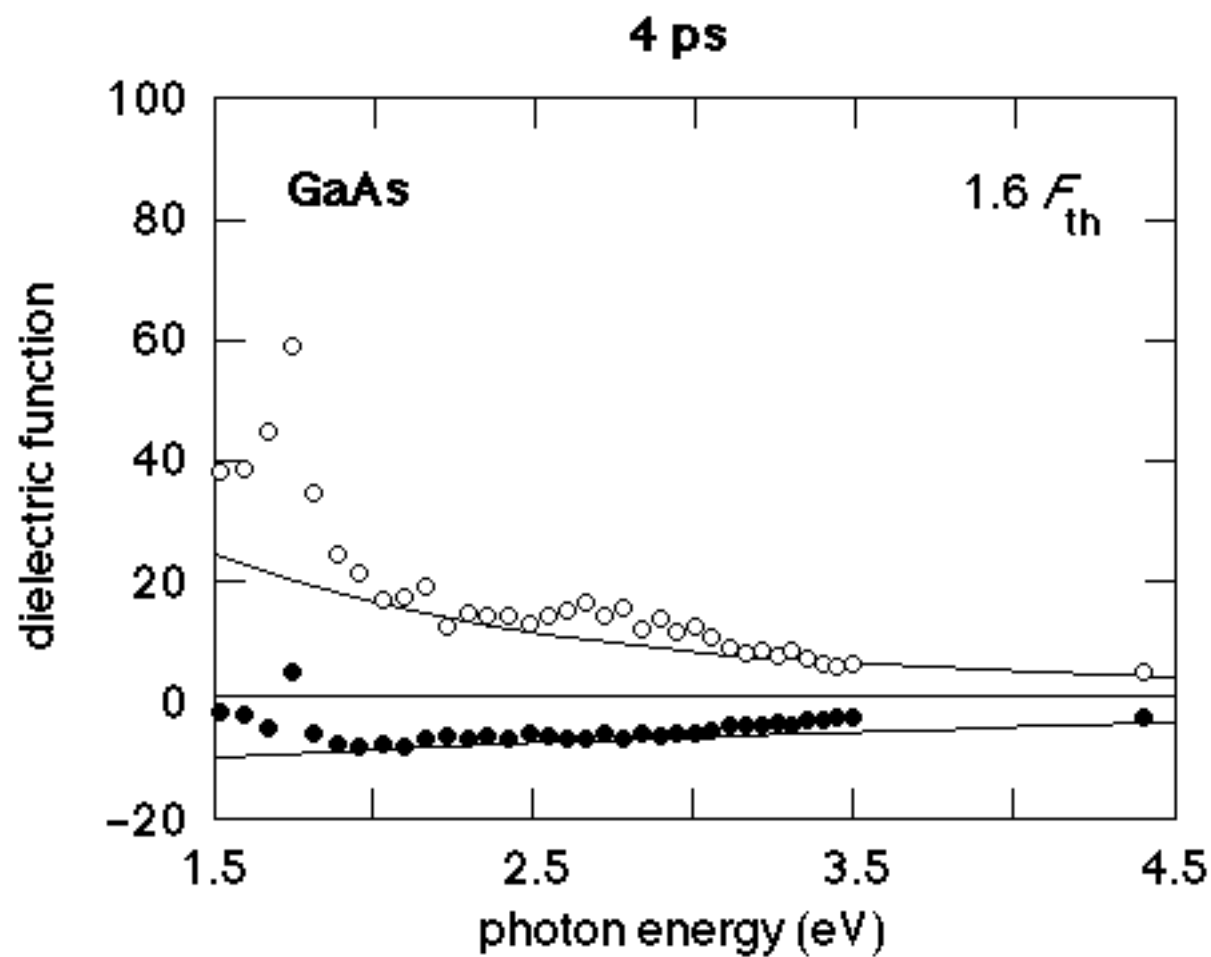

CARRIER DENSITY

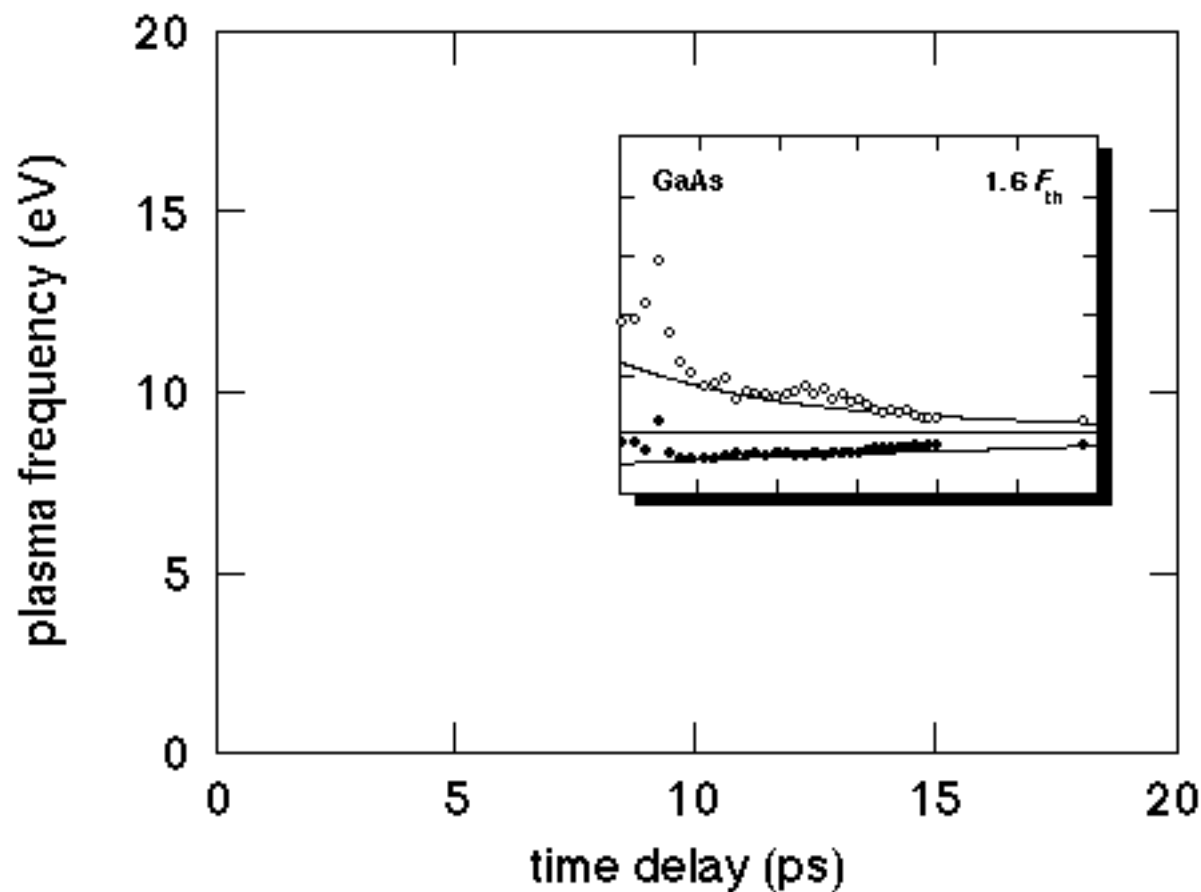

CARRIER DENSITY

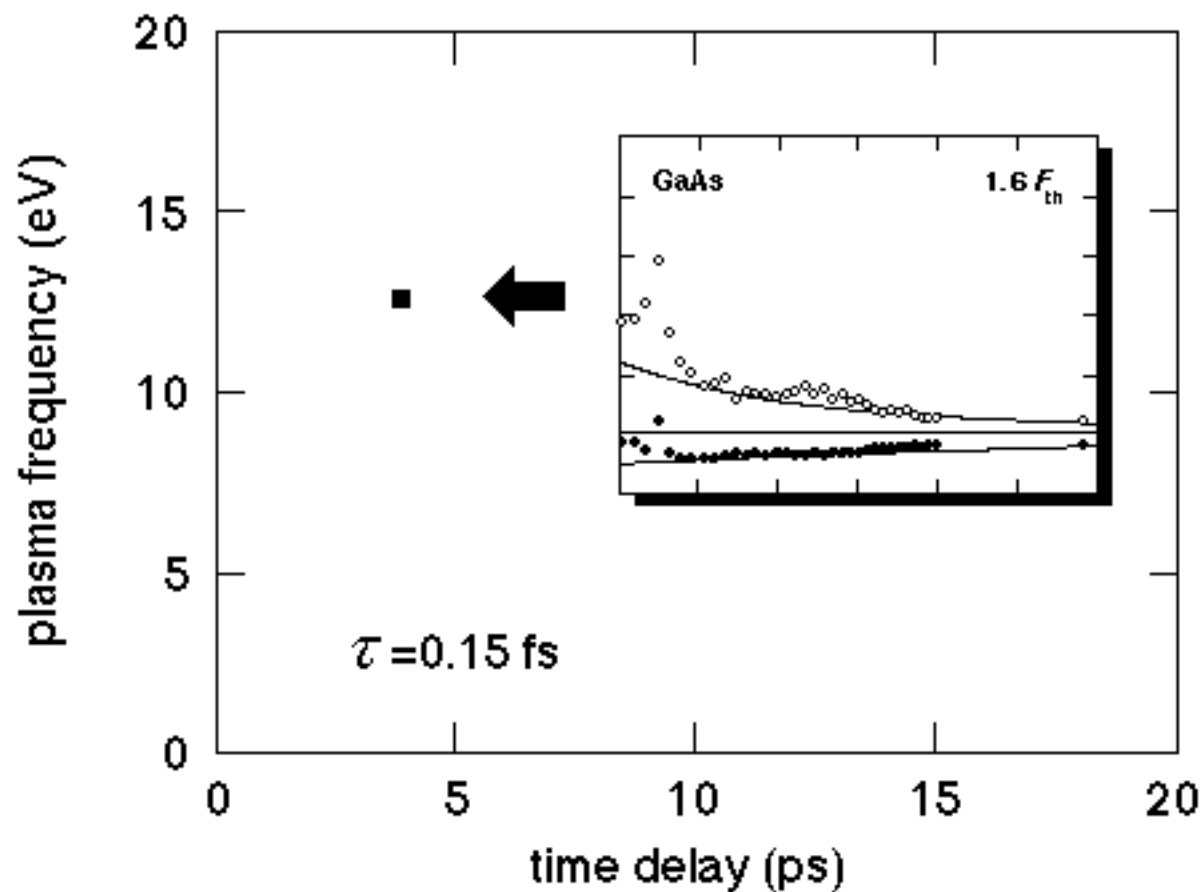

CARRIER DENSITY

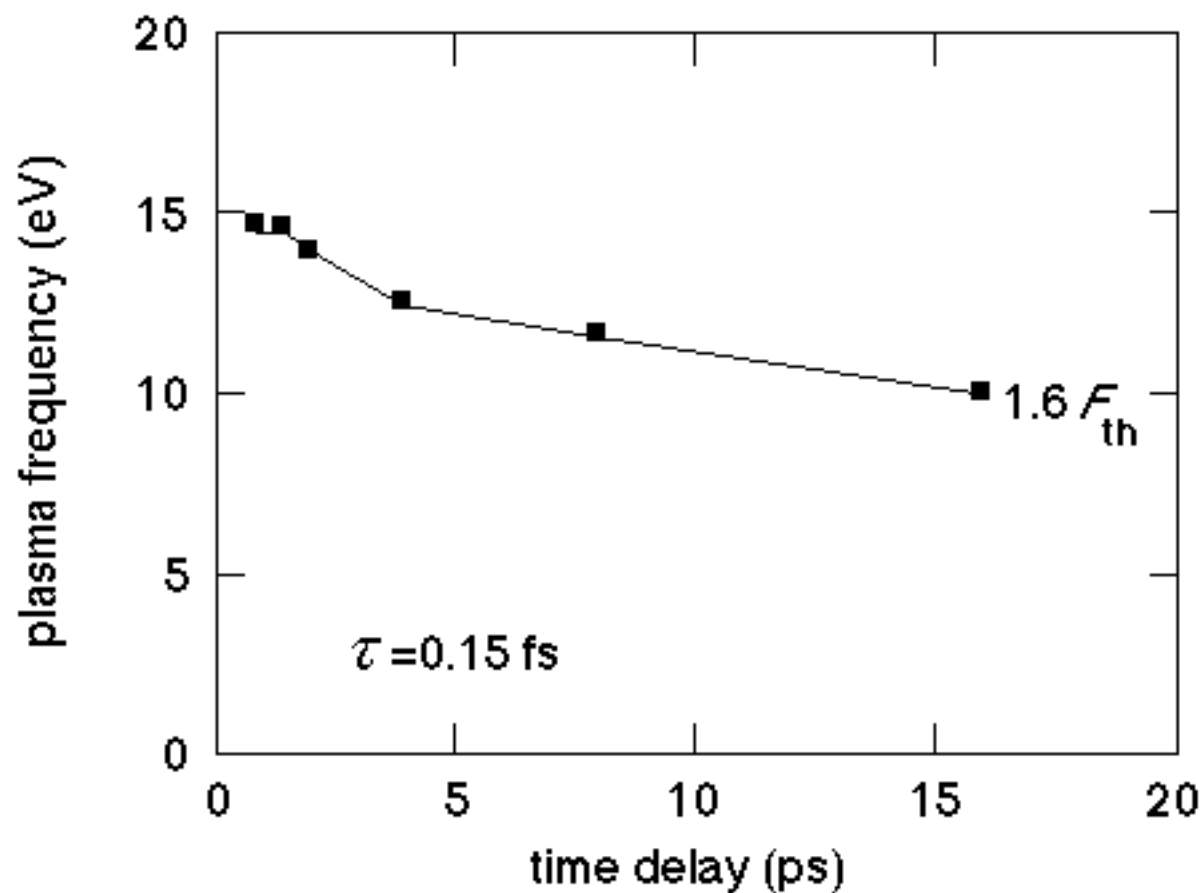

CARRIER DENSITY

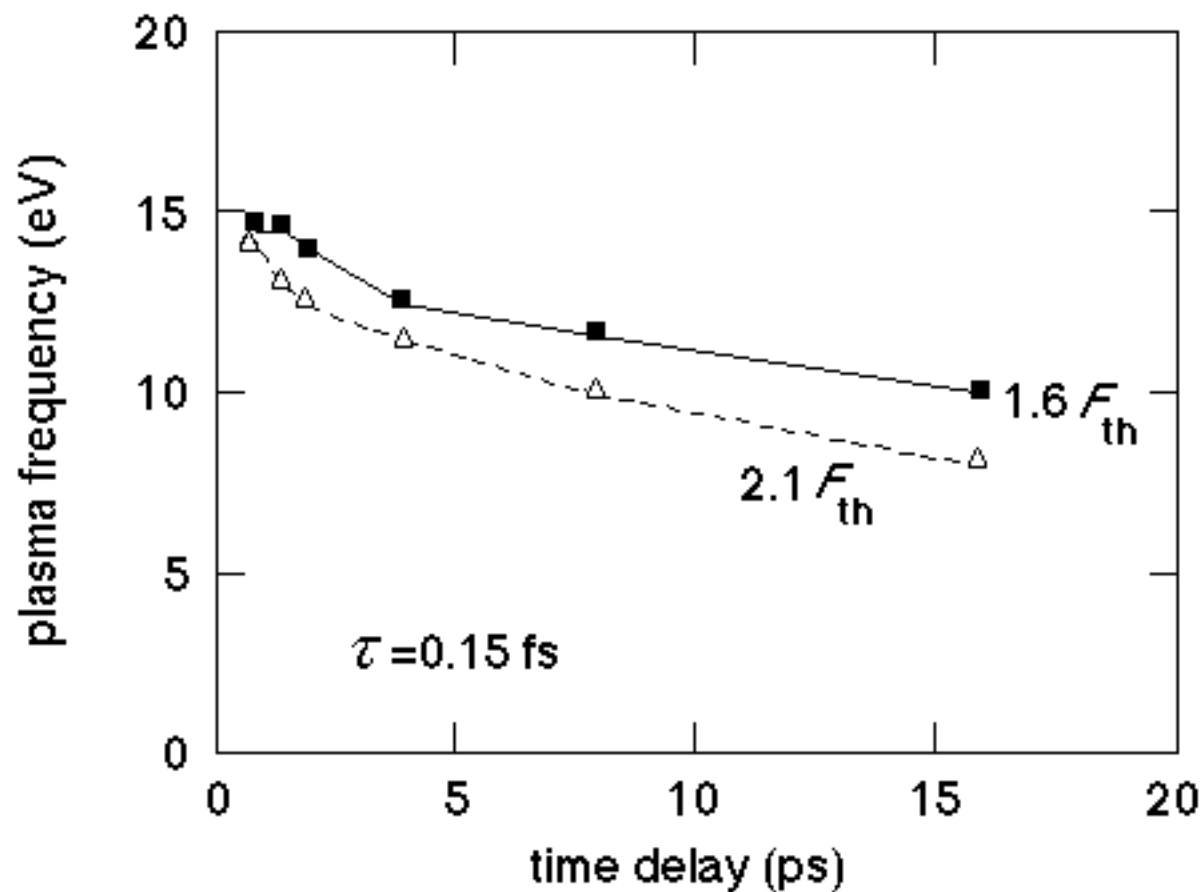

CARRIER DENSITY

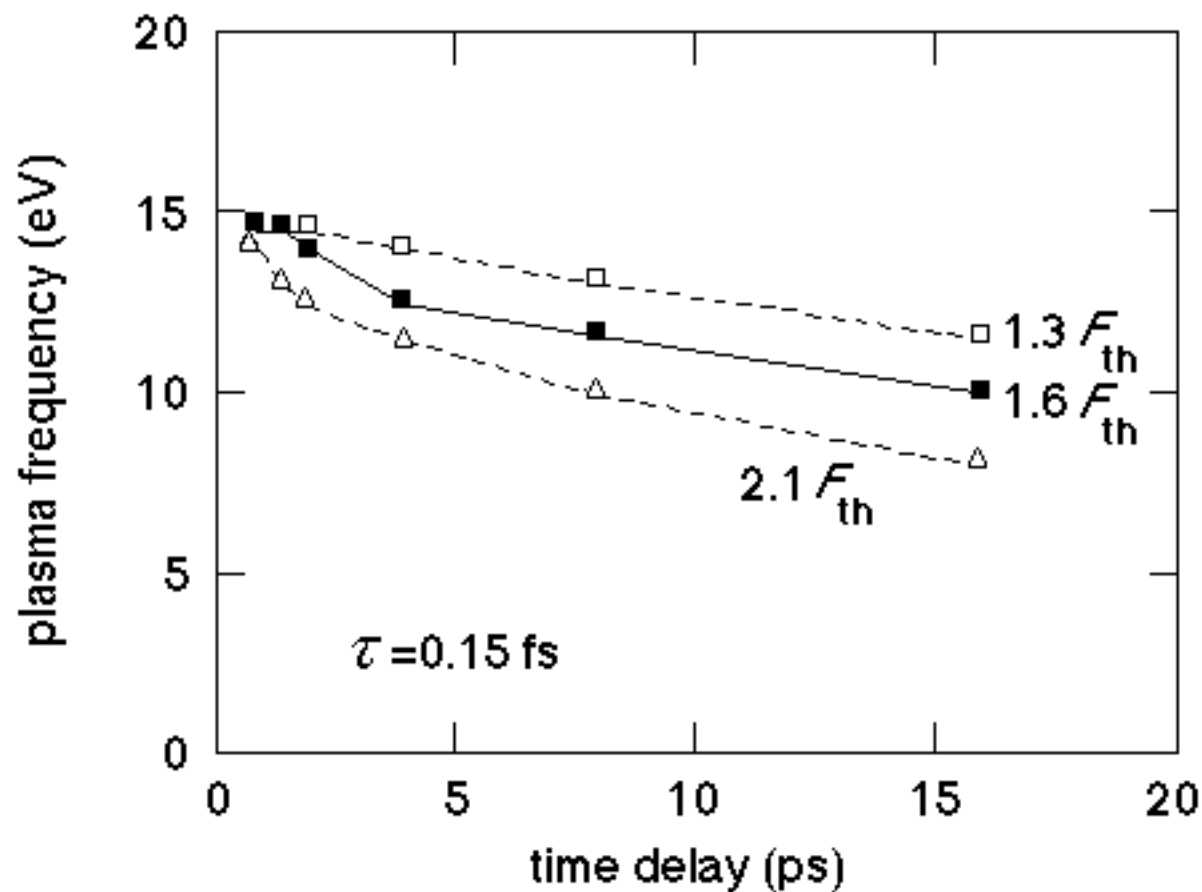

CARRIER DENSITY

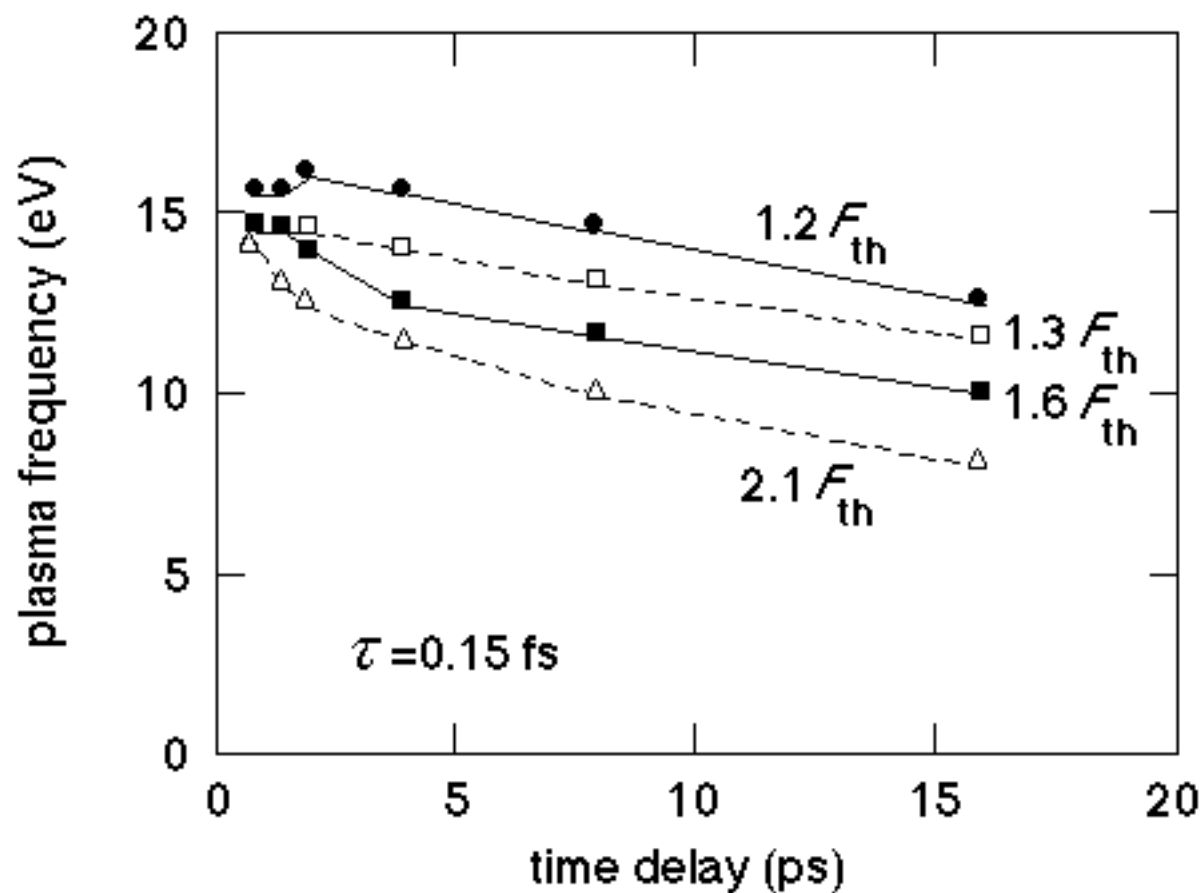

CARRIER DENSITY

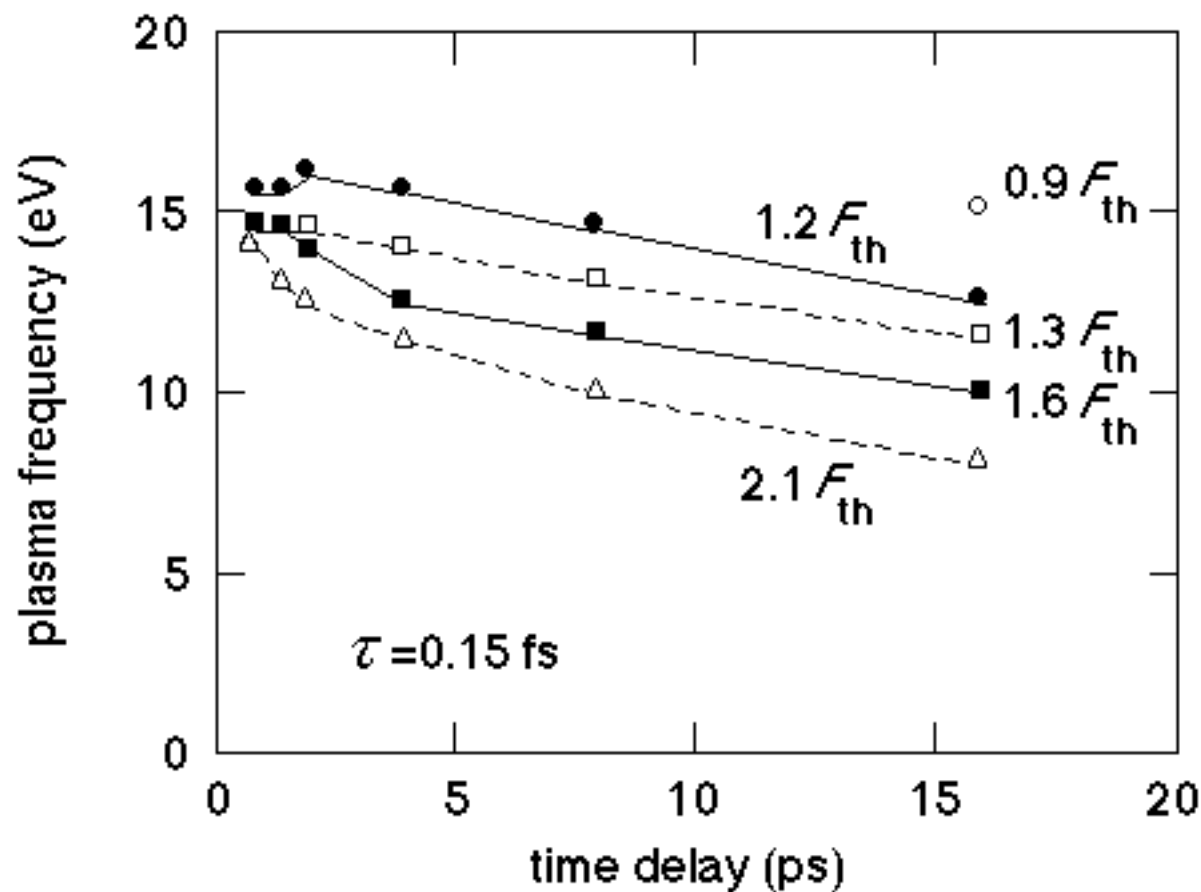

- ① Method
- ② Results
- ③ Discussion



DISCUSSION

structure

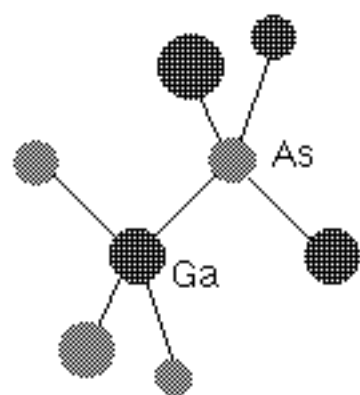

bandstructure

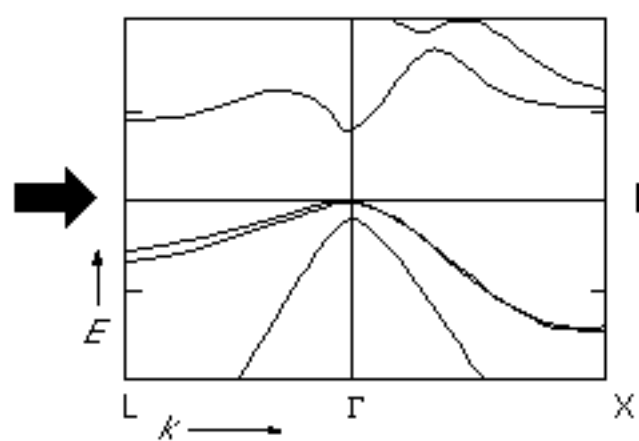

dielectric function

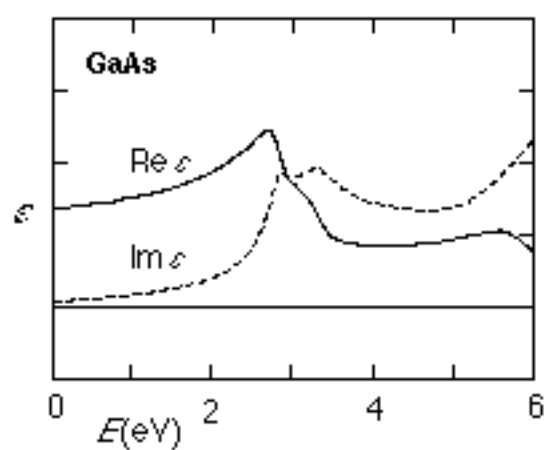

SHORT TIME SCALE (≈ 0.5 ps)

structure

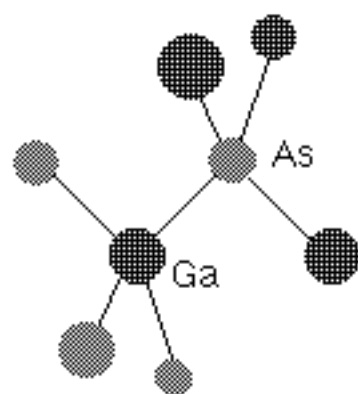

bandstructure

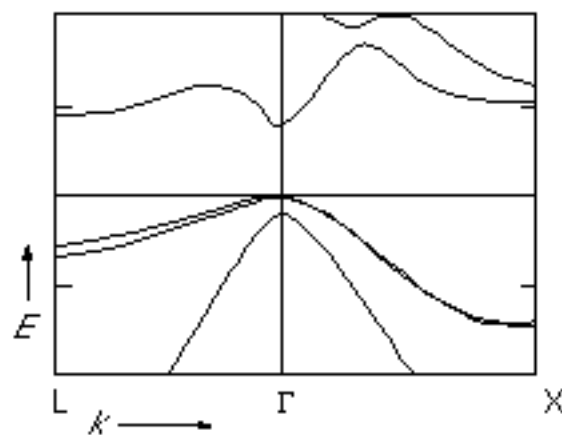

dielectric function

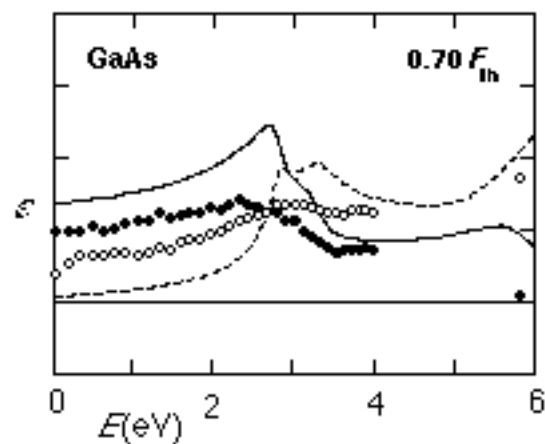

SHORT TIME SCALE (≈ 0.5 ps)

structure

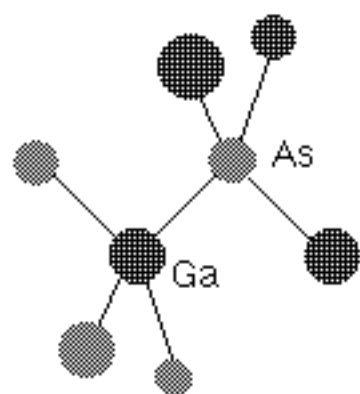

bandstructure

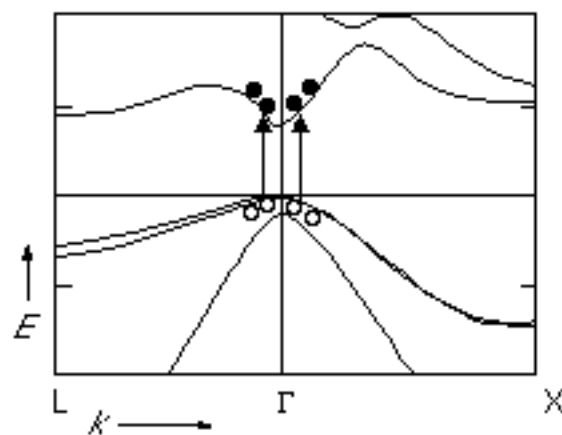

dielectric function

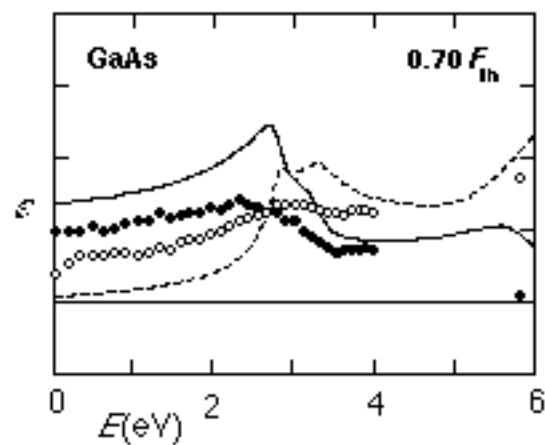

SHORT TIME SCALE (≈ 0.5 ps)

structure

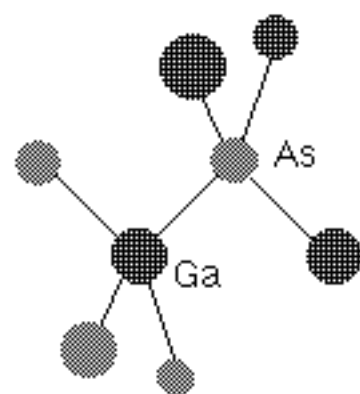

bandstructure

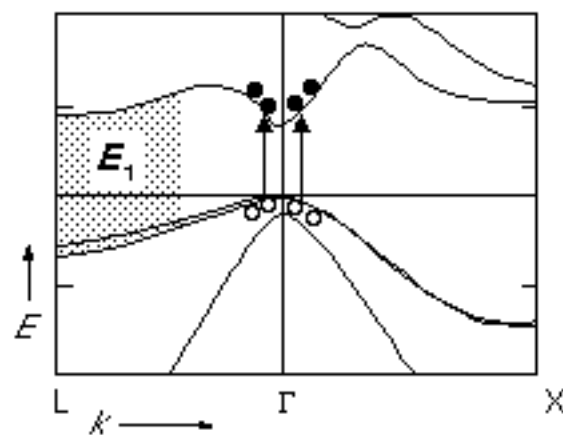

dielectric function

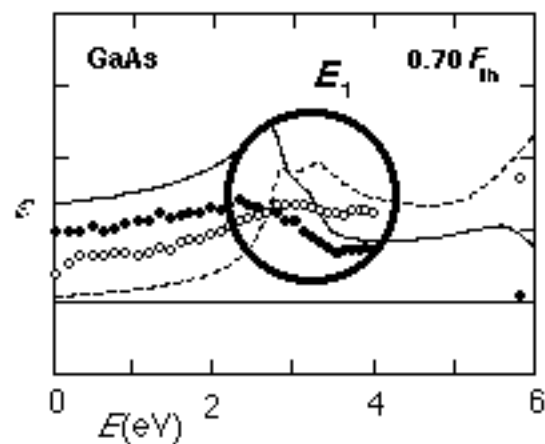

SHORT TIME SCALE (≈ 0.5 ps)

structure

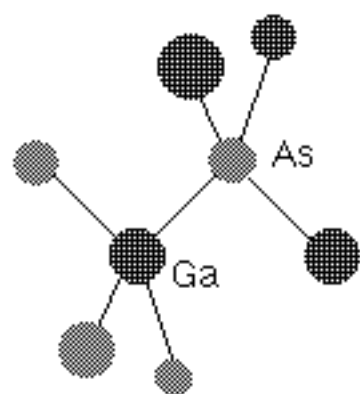

bandstructure

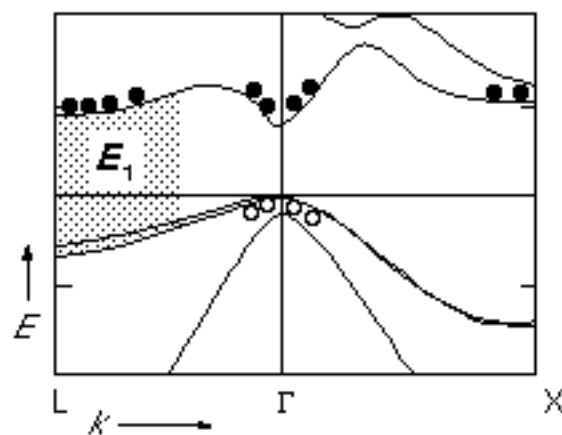

dielectric function

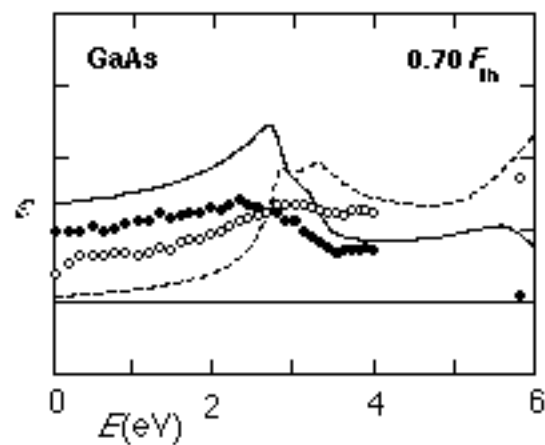

SHORT TIME SCALE (≈ 0.5 ps)

structure

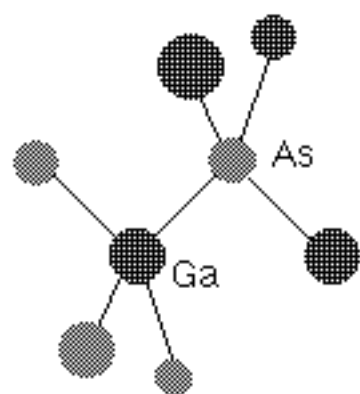

bandstructure

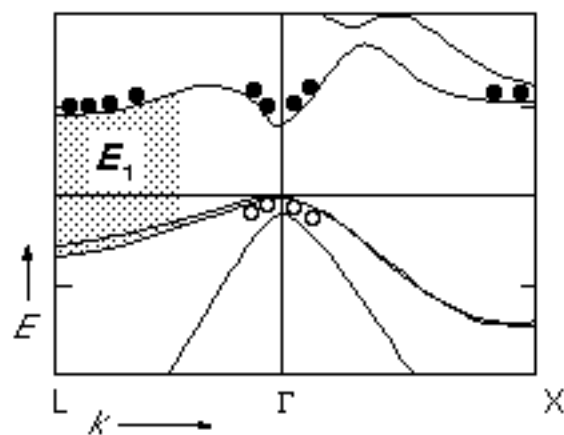

dielectric function

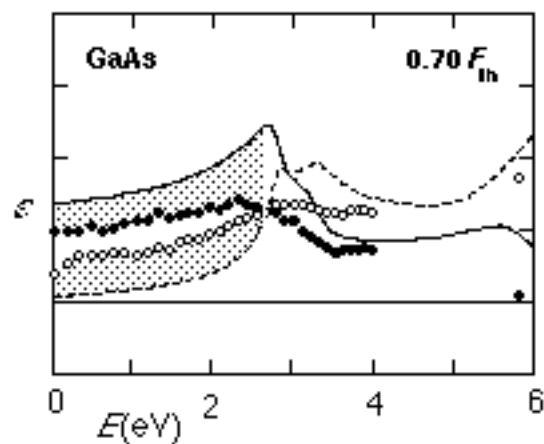

SHORT TIME SCALE (≈ 0.5 ps)

structure

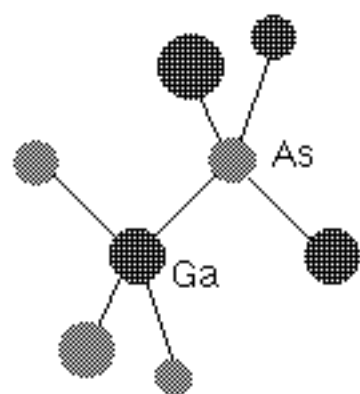

bandstructure

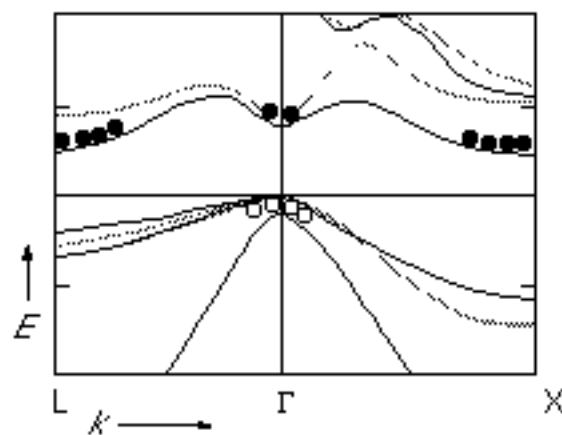

dielectric function

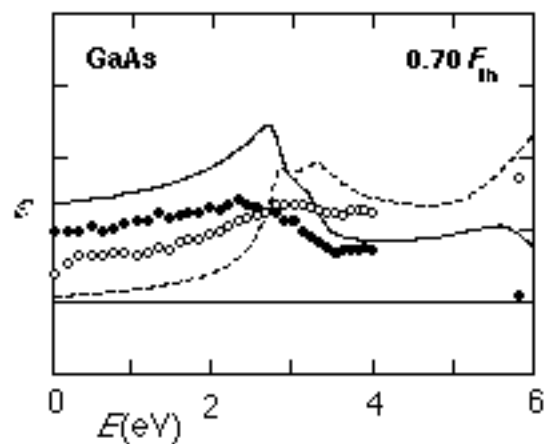

SHORT TIME SCALE (≈ 0.5 ps)

structure

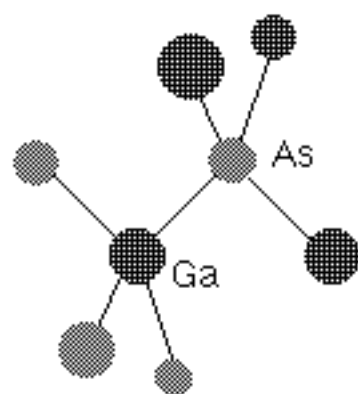

bandstructure

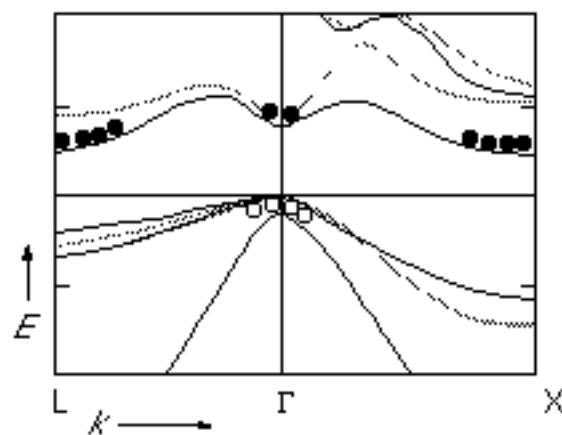

dielectric function

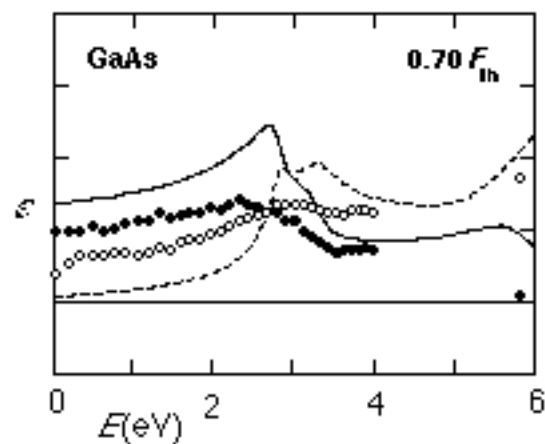

► electronic effects dominate at short time scales...



SHORT TIME SCALE (≈ 0.5 ps)

structure

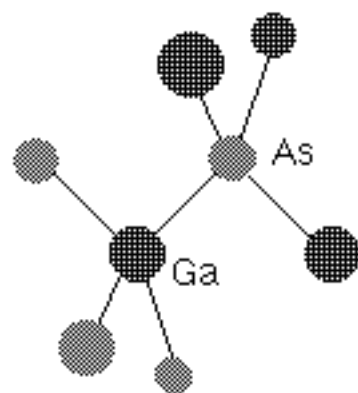

bandstructure

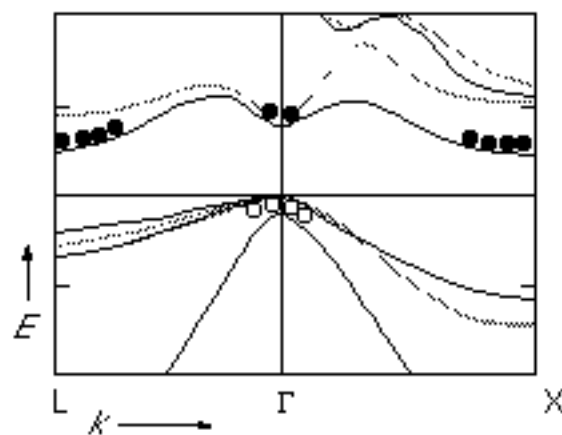

dielectric function

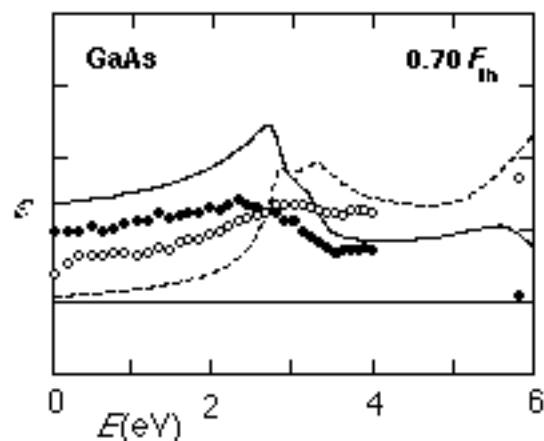

► ...but they are not as simple as we used to think



LOW FLUENCE, LONG TIME SCALE

structure

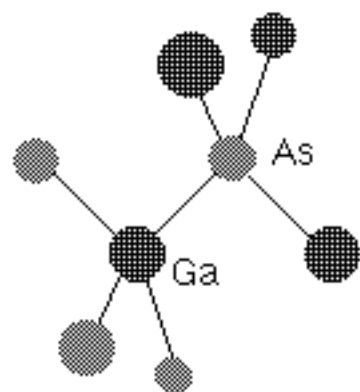

bandstructure

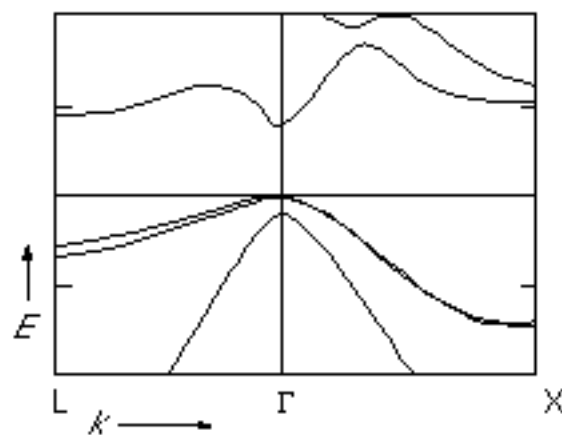

dielectric function

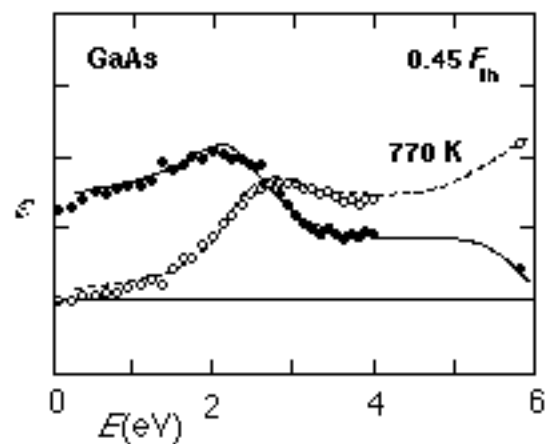

LOW FLUENCE, LONG TIME SCALE

structure

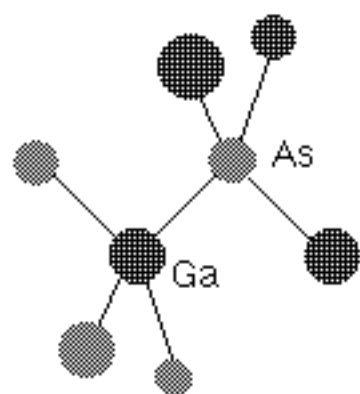

bandstructure

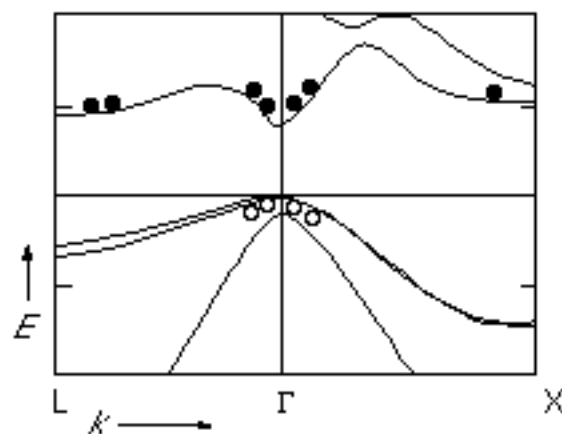

dielectric function

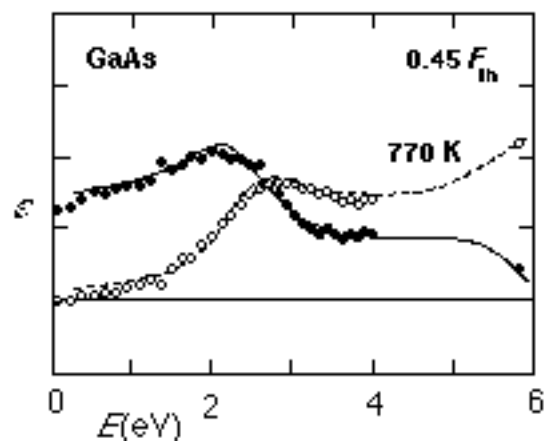

carrier density down, electronic effects subsided...



LOW FLUENCE, LONG TIME SCALE

structure

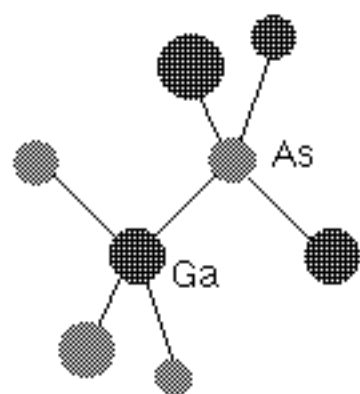

bandstructure

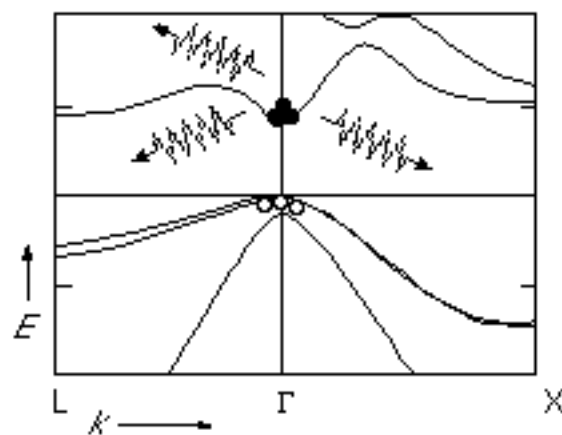

dielectric function

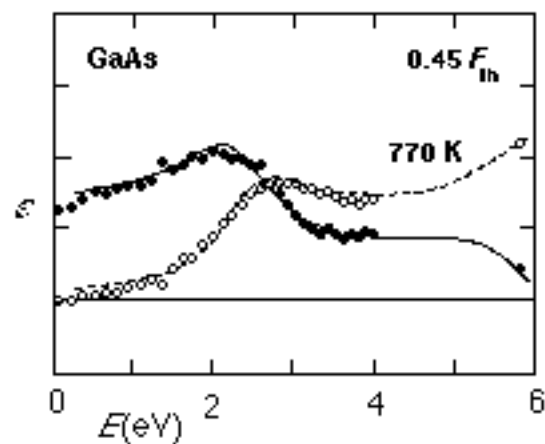

...and lattice heats due to carrier relaxation



LOW FLUENCE, LONG TIME SCALE

structure

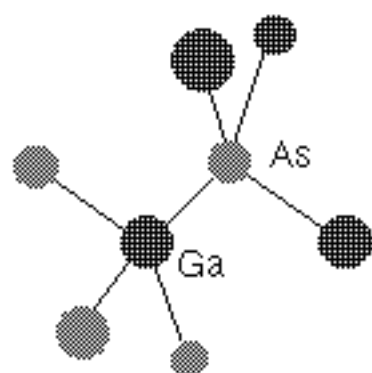

bandstructure

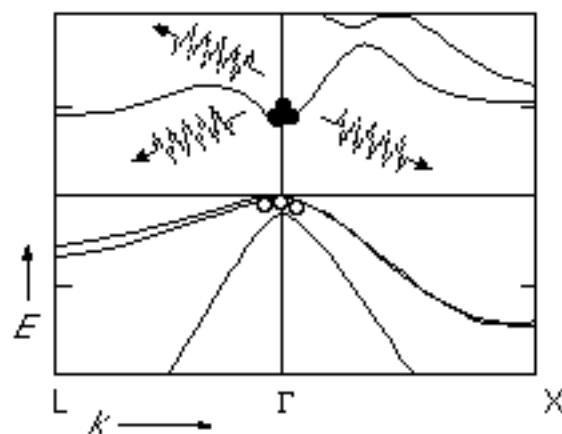

dielectric function

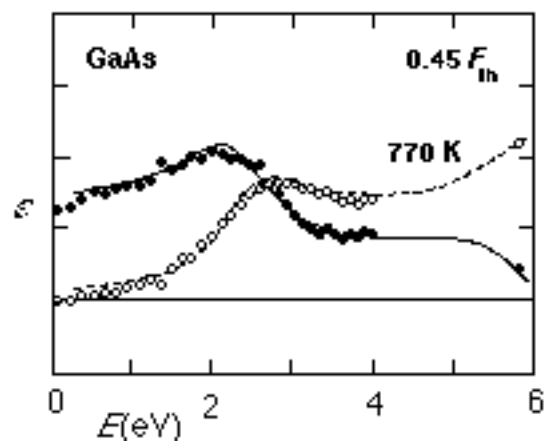

...and lattice heats due to carrier relaxation



LOW FLUENCE, LONG TIME SCALE

structure

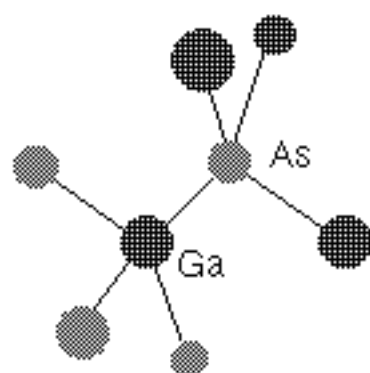

bandstructure

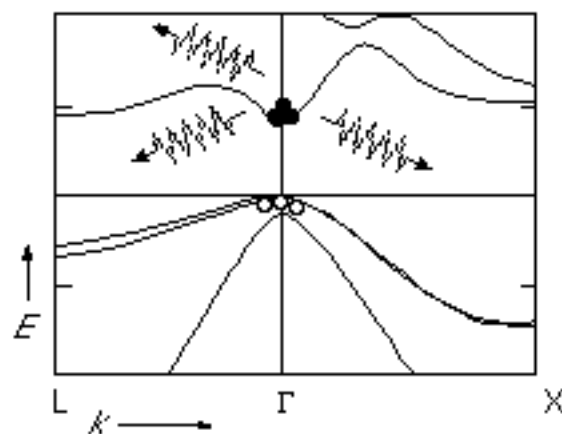

dielectric function

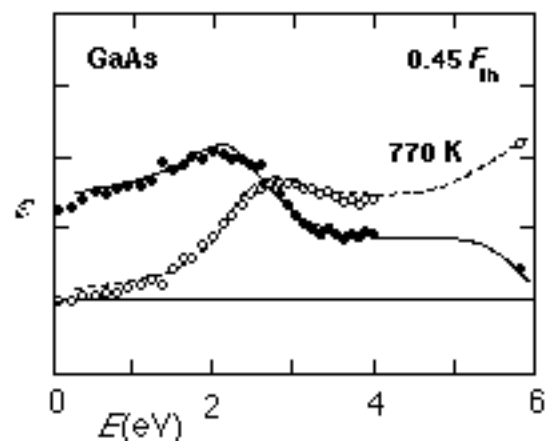

But... why do electronic effects disappear after 2 ps while lattice heats in 7 ps?



LOW FLUENCE, LONG TIME SCALE

Auger recombination

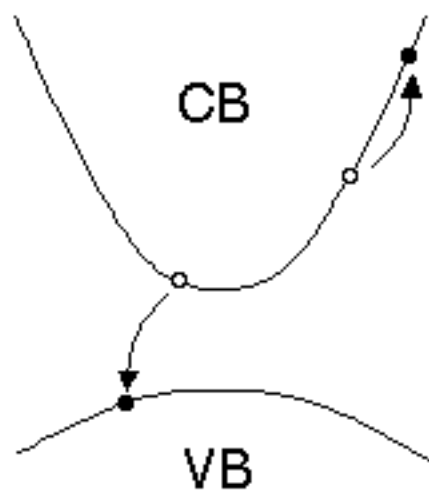

Auger lowers N without changing E in 2–4 ps...



LOW FLUENCE, LONG TIME SCALE

carrier-phonon scattering

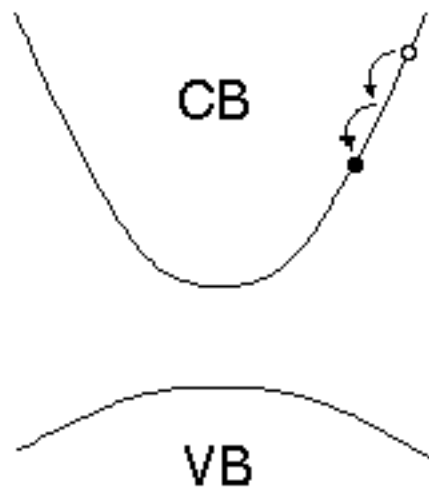

... and highly excited electrons cool to lattice in 7 ps



HIGH FLUENCE, LONG TIME SCALE

structure

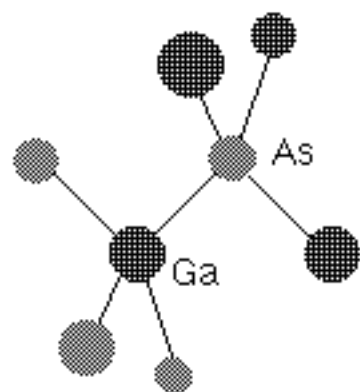

bandstructure

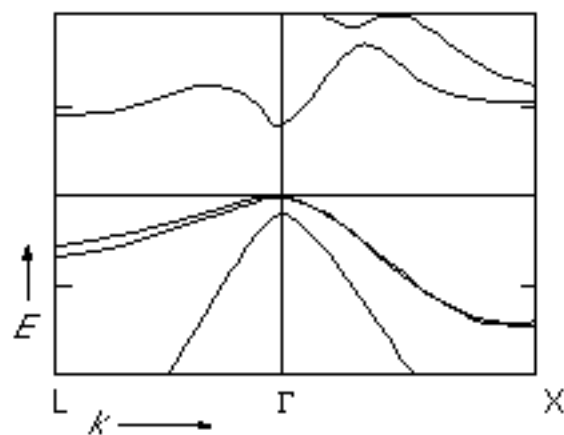

dielectric function

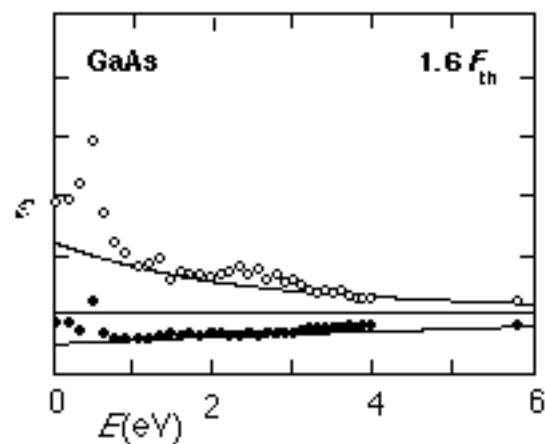

HIGH FLUENCE, LONG TIME SCALE

structure

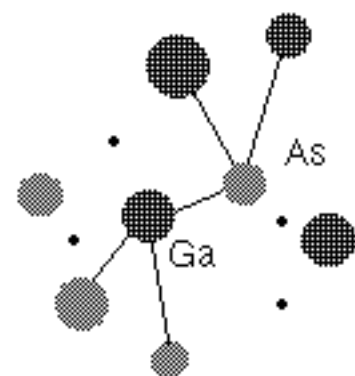

bandstructure

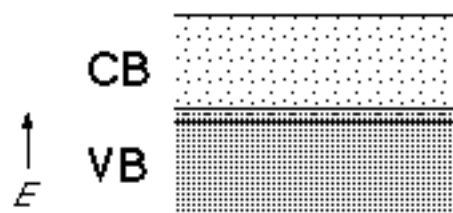

dielectric function

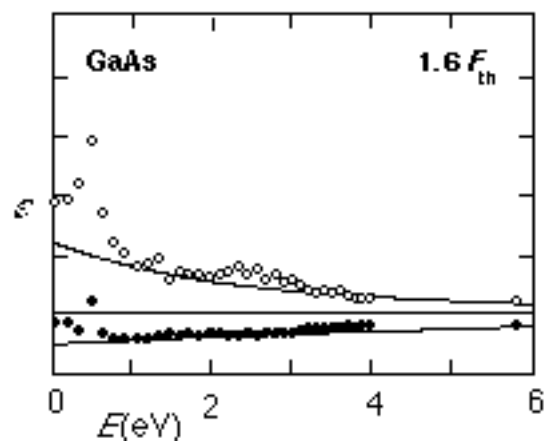

gradual drop in gap \rightarrow not electronic effect



OVERVIEW

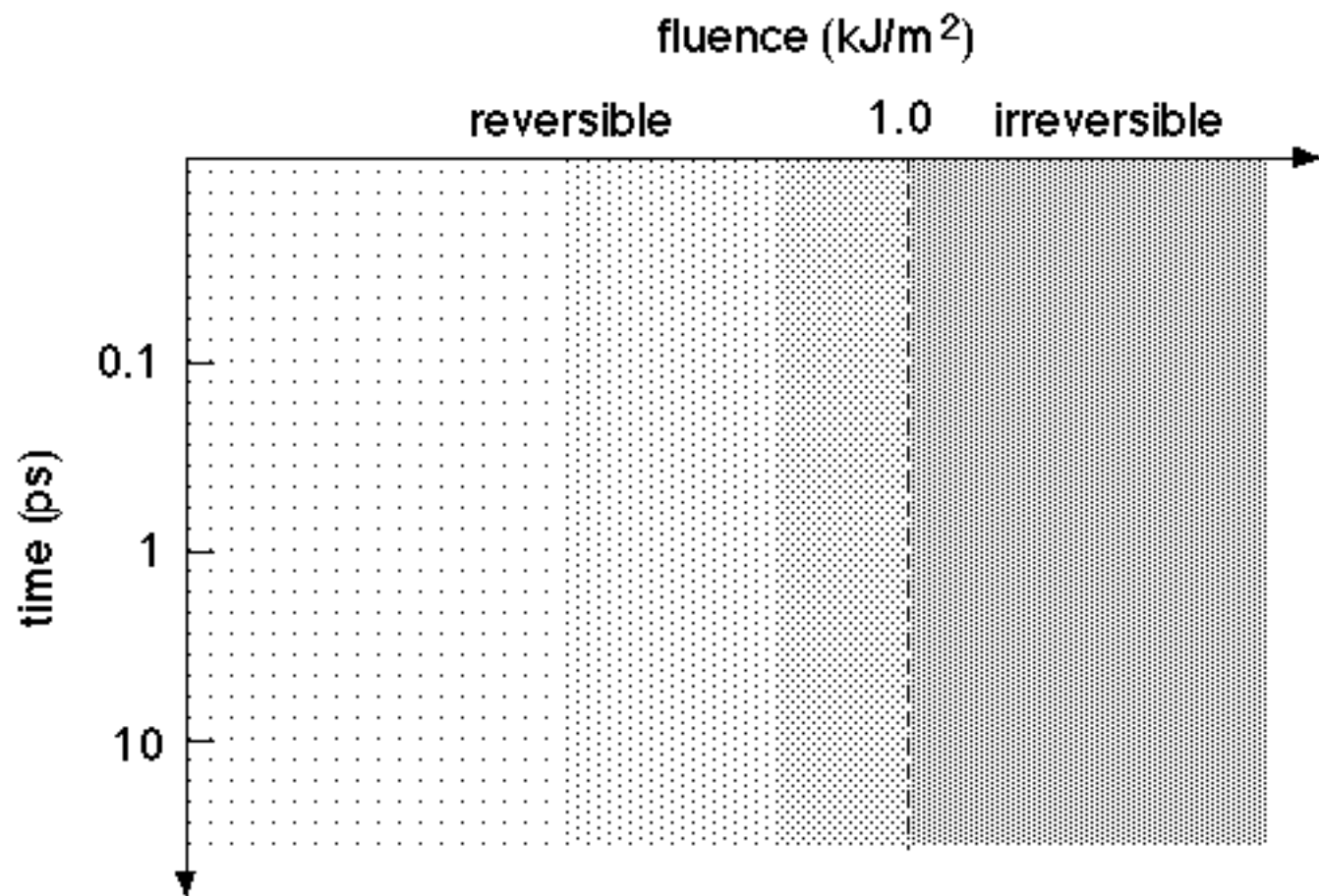

OVERVIEW

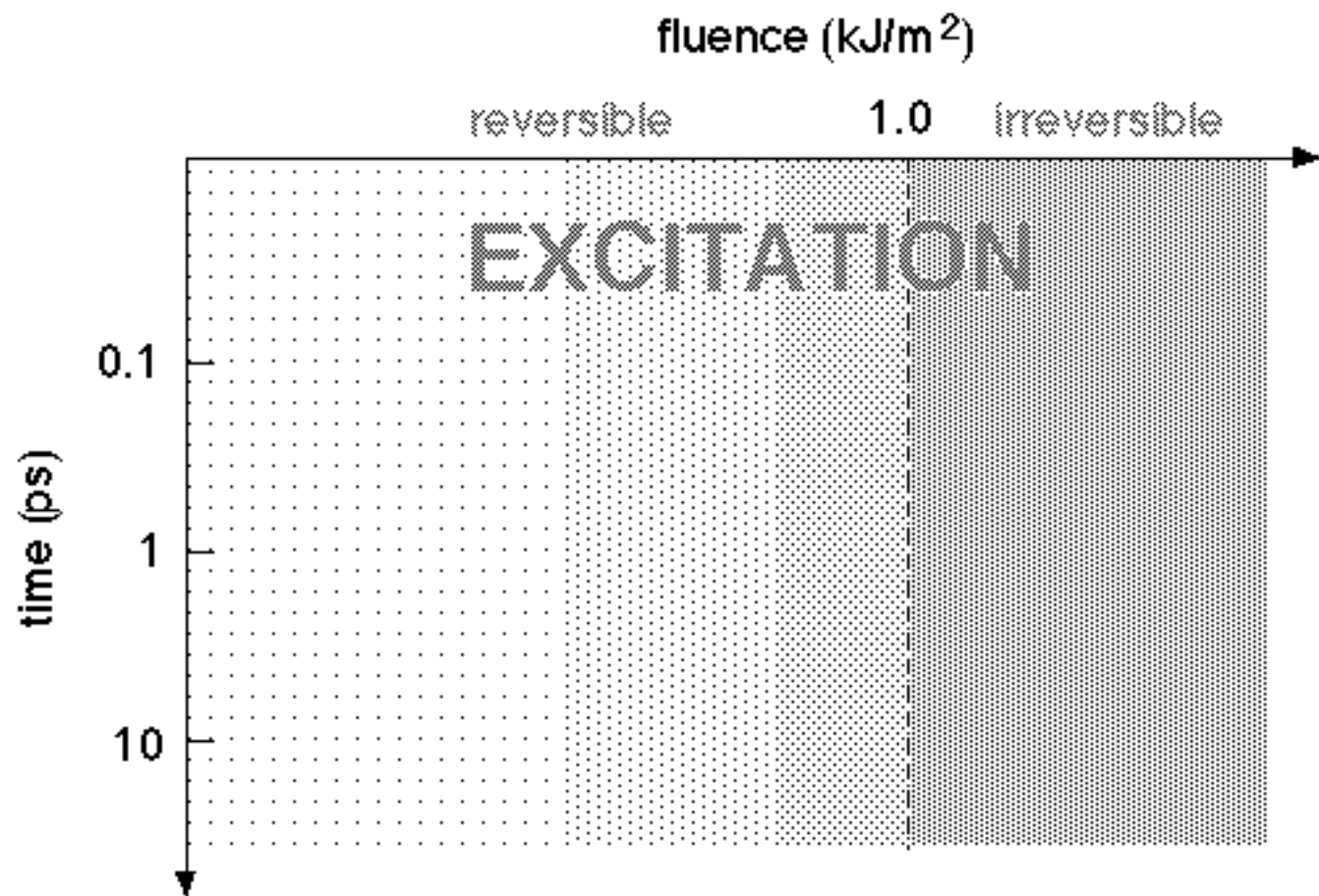

OVERVIEW

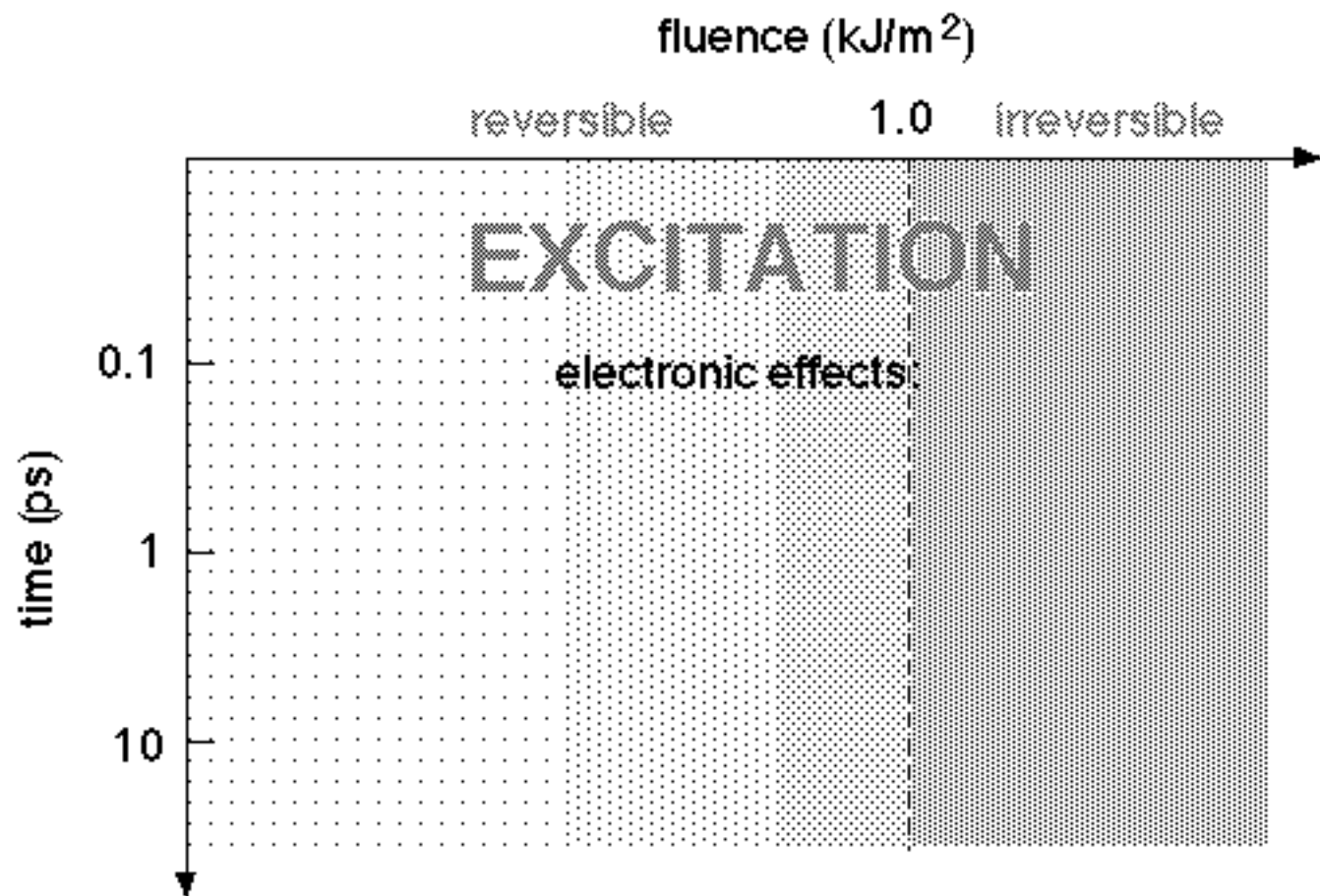

OVERVIEW

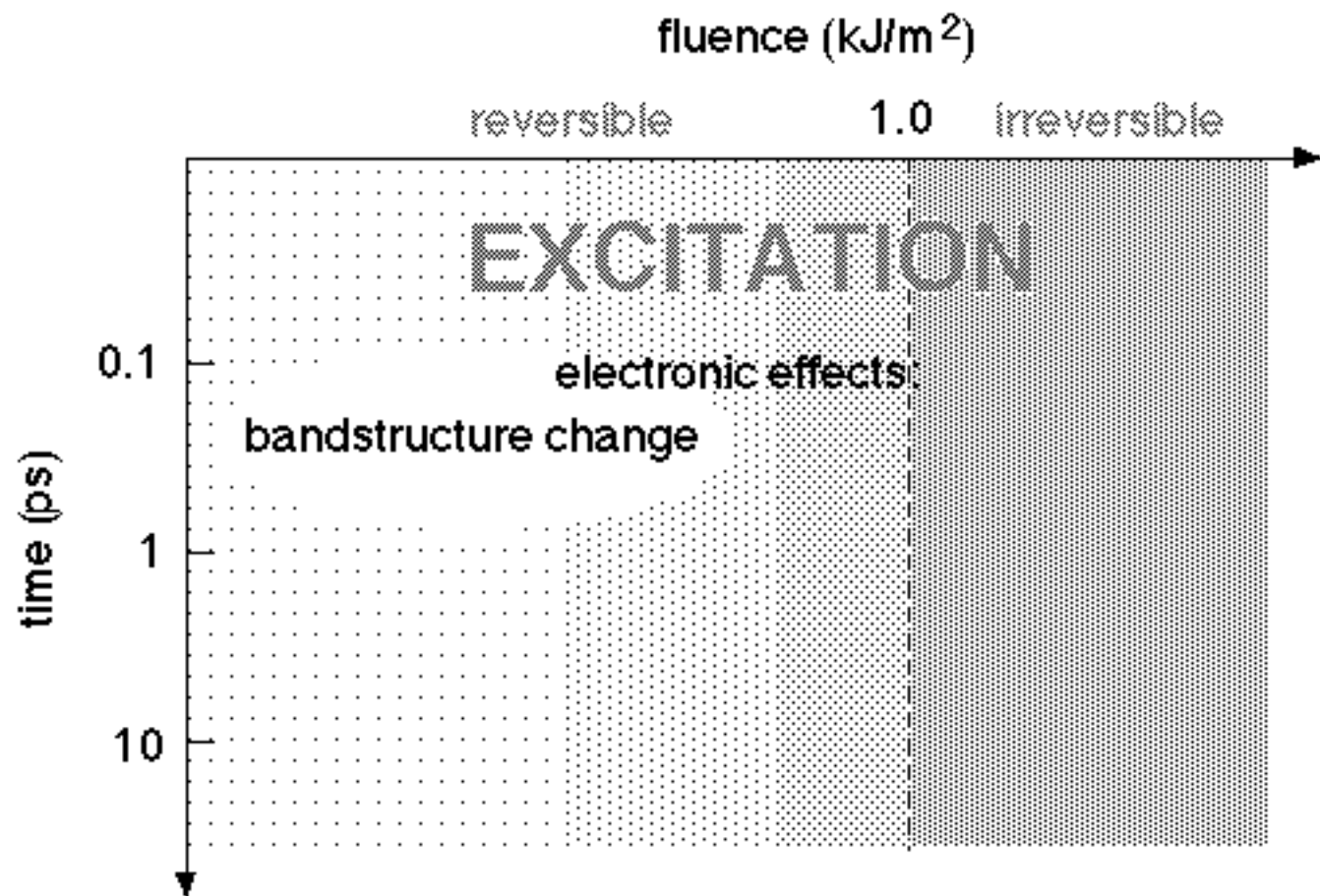

OVERVIEW

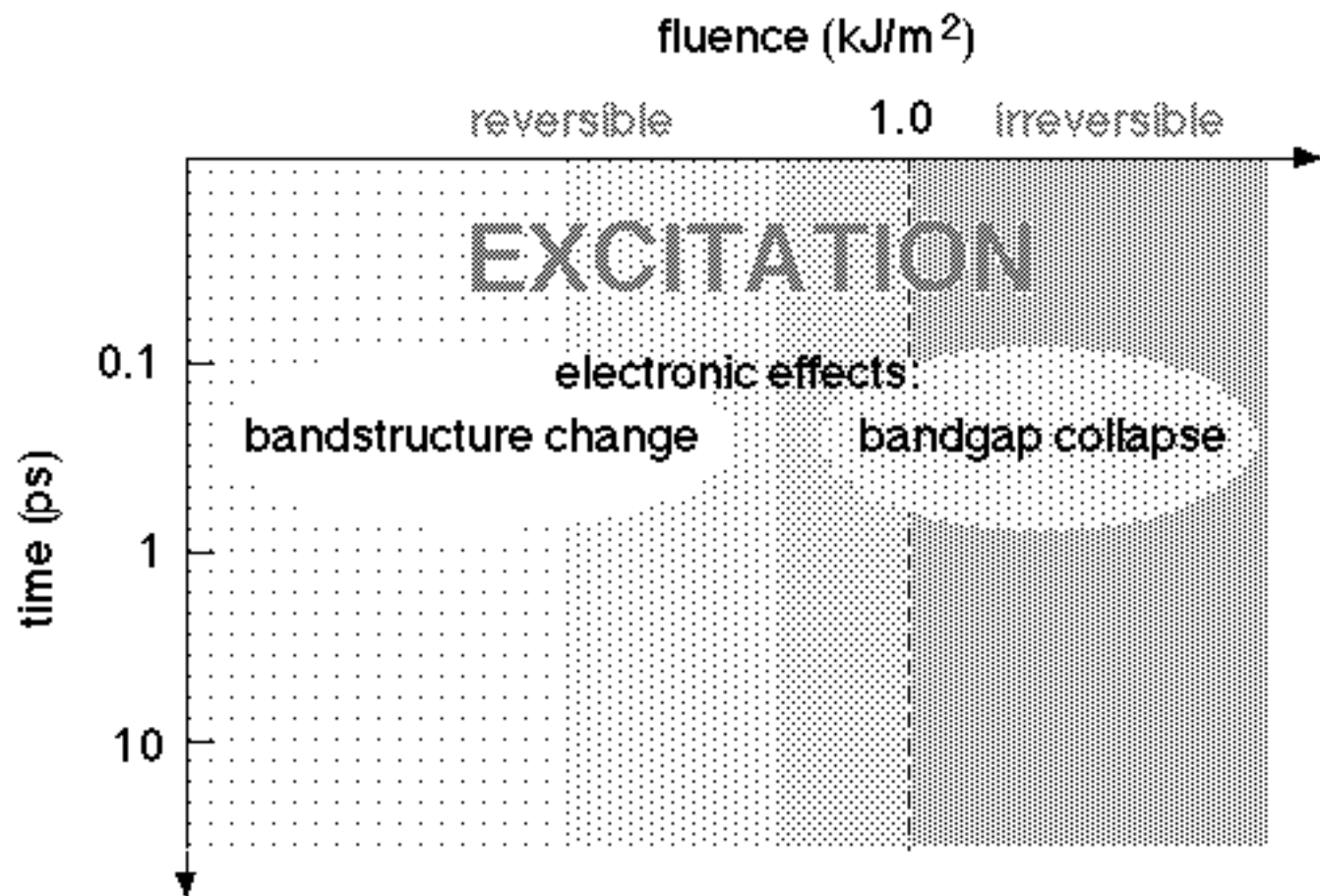

OVERVIEW

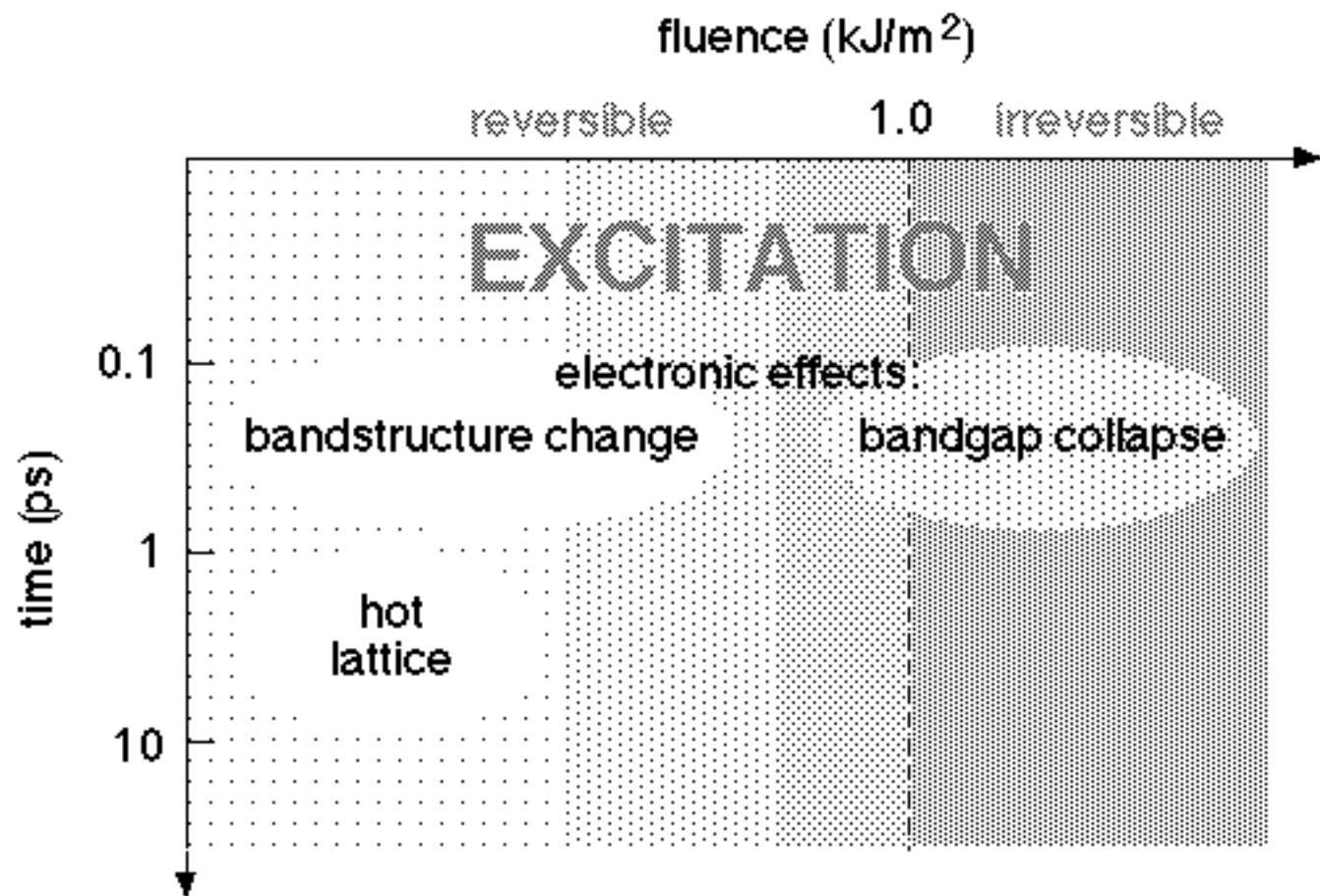

OVERVIEW

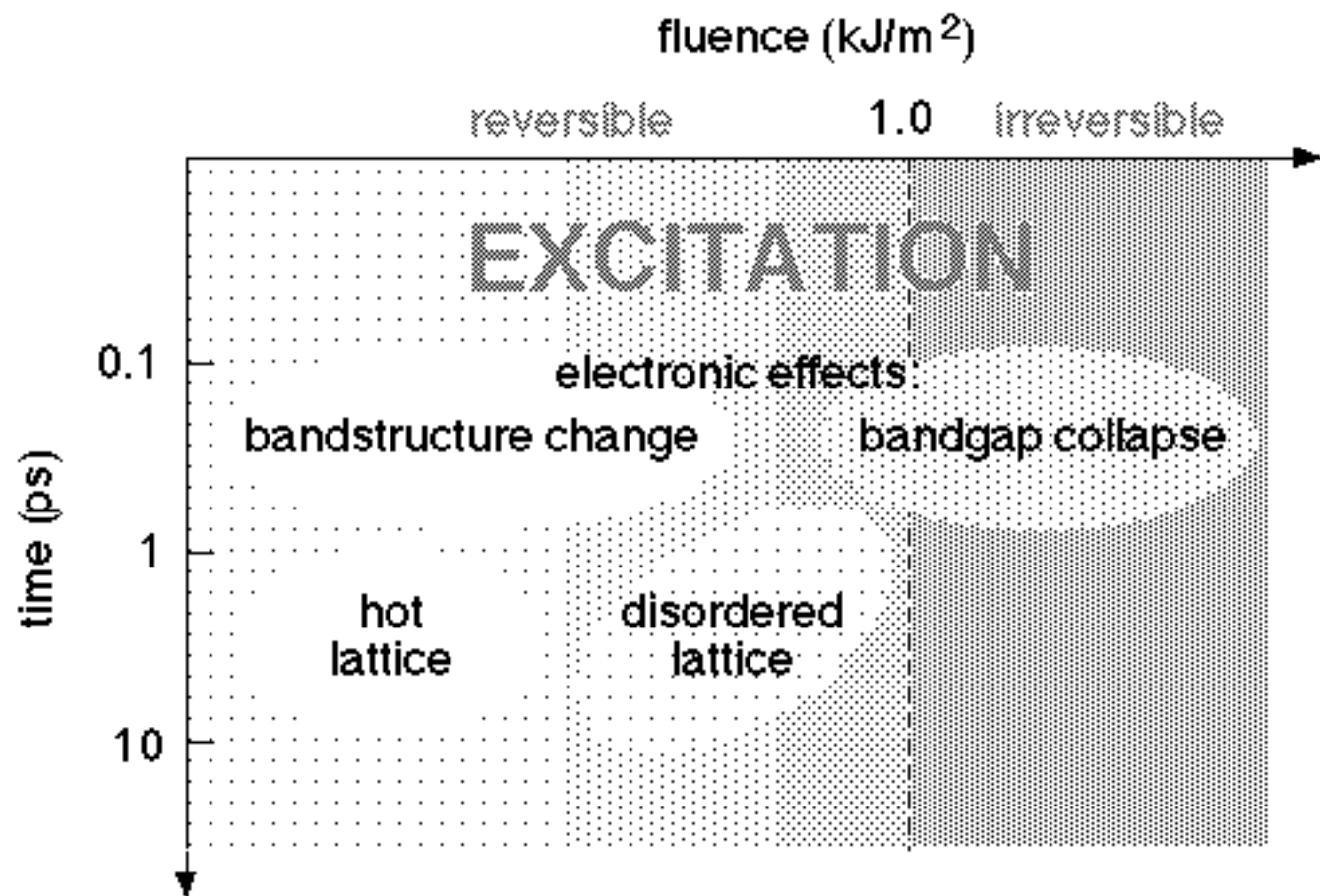

OVERVIEW

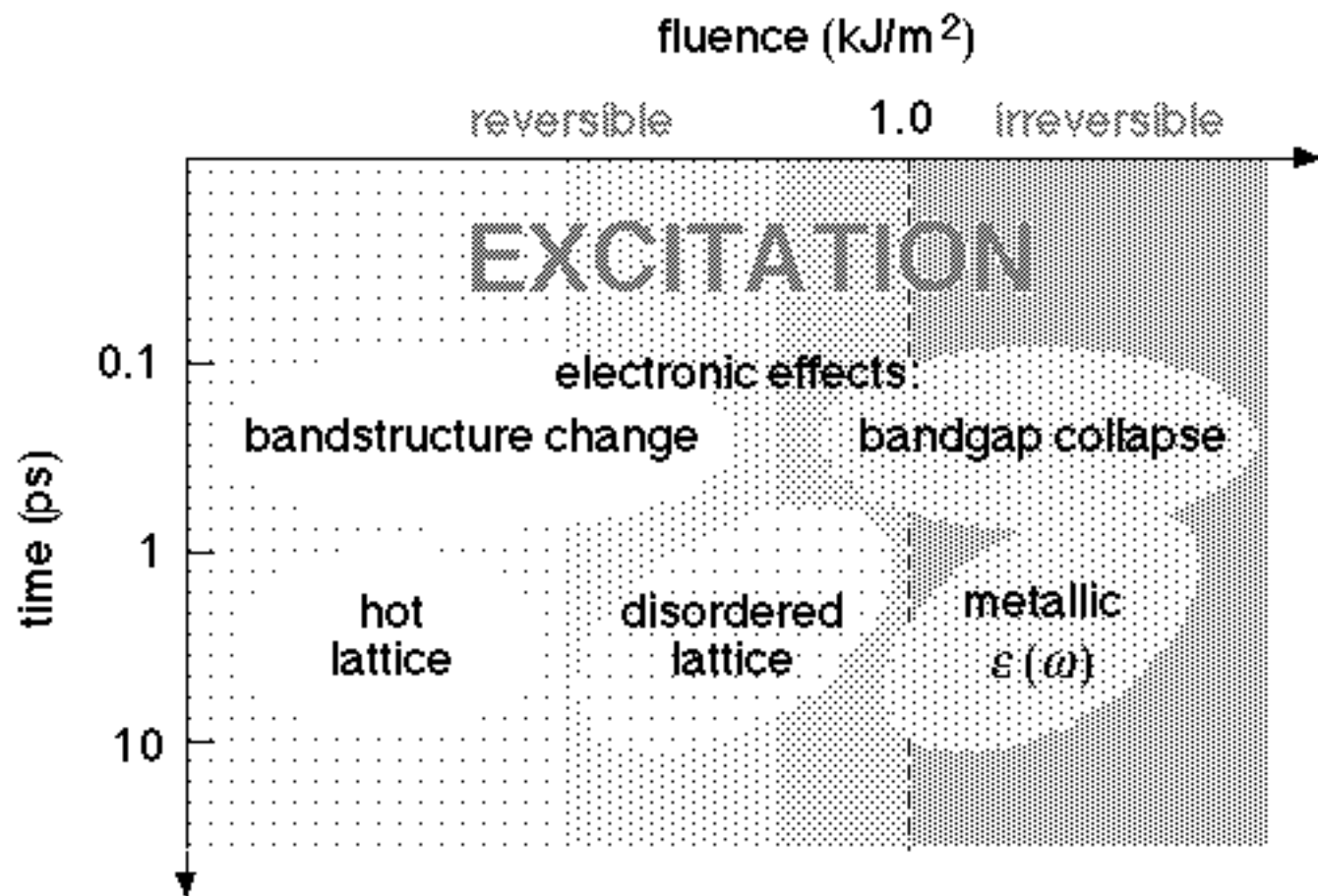

- ▶ measurement of $\epsilon(\omega)$ identifies ultrafast phase changes
- ▶ initial response is electronic, via band structure and electron occupation changes
- ▶ structural effects dominate after a few ps
- ▶ interesting reversible regime



- ▶ strong electronic excitation can drive a structural transition
- ▶ femtosecond lasers allow us to see the dynamics of the transition



Acknowledgments

Prof. Bloembergen
Prof. Ehrenreich
Prof. Kaxiras
Prof. Klingshirn

ONR, NSF

<http://mazor-www.harvard.edu>

