

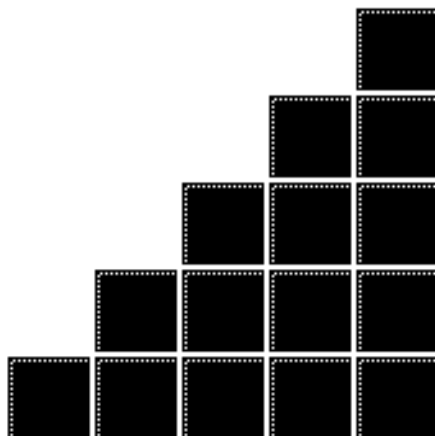

WHY WASTE TIME? TURN YOUR LECTURES INTO DISCUSSIONS!

*Eric Mazur
Harvard University*

*AAPT New Faculty Workshop
College Park, MD
13 November 1998*



① Problem

② Cause

③ Remedy

PROBLEM? WHAT PROBLEM?

Traditional science education ineffective...

- lack of understanding
- frustration
- lack of basic knowledge



LACK OF UNDERSTANDING



LACK OF UNDERSTANDING

Well, "hot" is a relative term...

You see, given temperatures rise, regardless of mass.

Yeah, Galileo observed rising temperatures will decrease with the exposure of an endothermic source.

Endothermic?

True transparence will persist until this one irresistible calorie interacts, thus altering the system.



FRUSTRATION



FRUSTRATION

“I took four years of science and four years of math...

A waste of my time,
a waste of the teacher's time,
and a waste of space...

You know,
I took *physics*.
For *what?*”

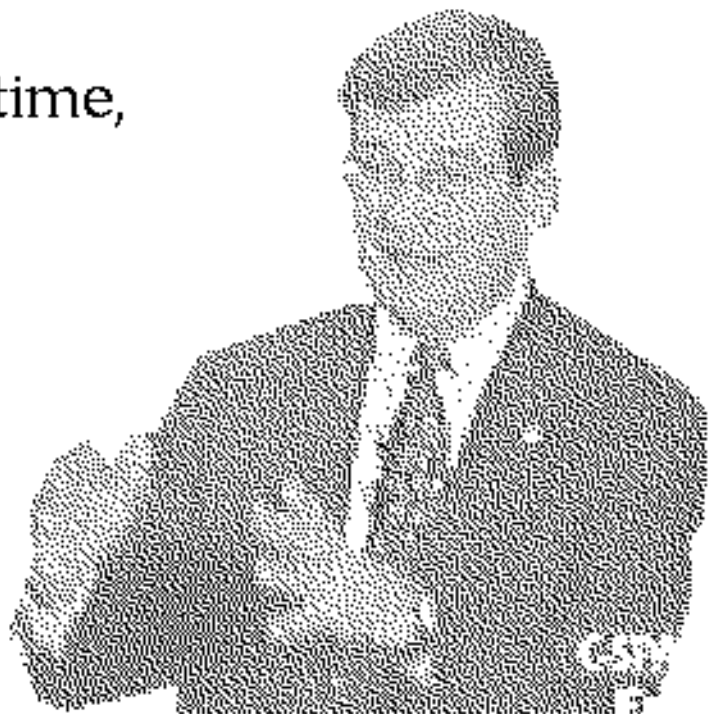

FRUSTRATION



LACK OF BASIC KNOWLEDGE



① Problem

② Cause

③ Remedy

THE CAUSE

1. Lectures focus on transfer of information...

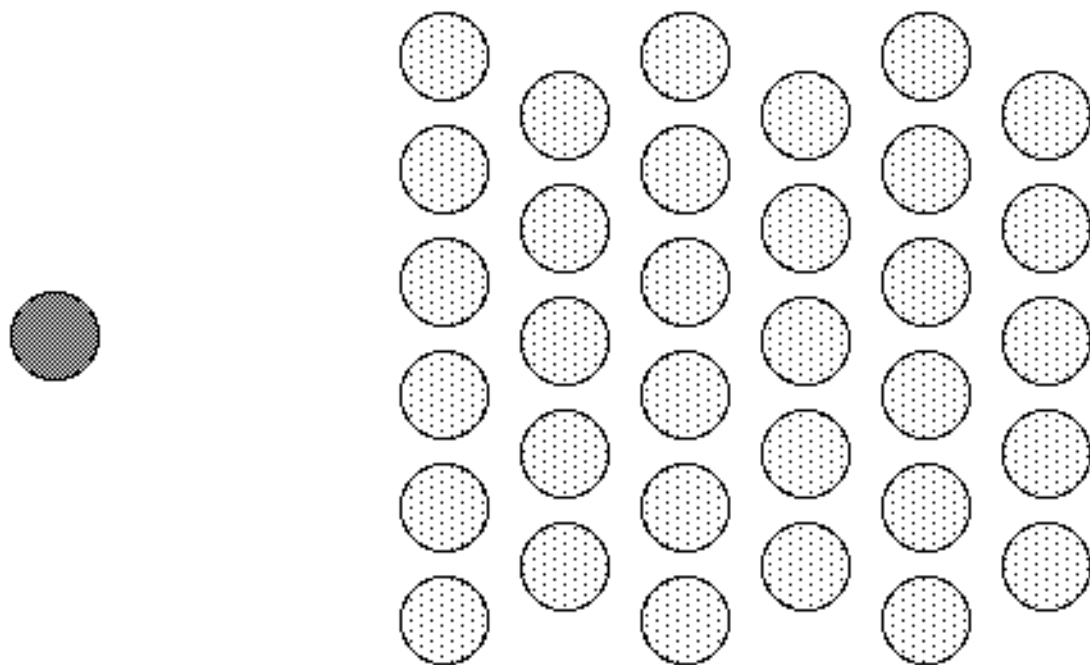

THE CAUSE

... but the information doesn't sink in!

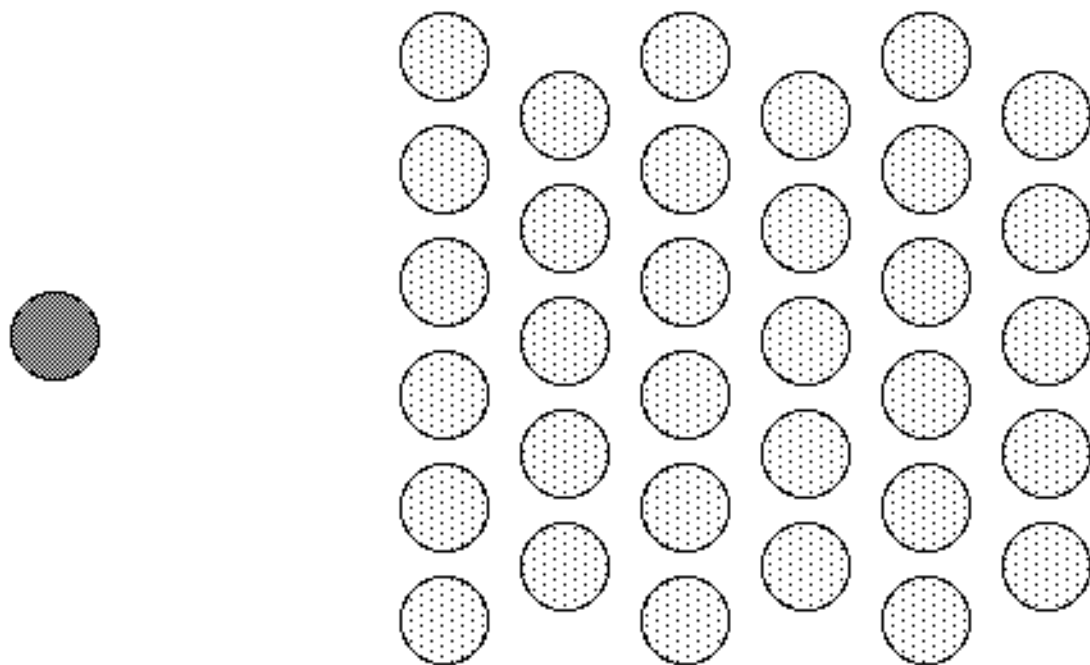

THE CAUSE

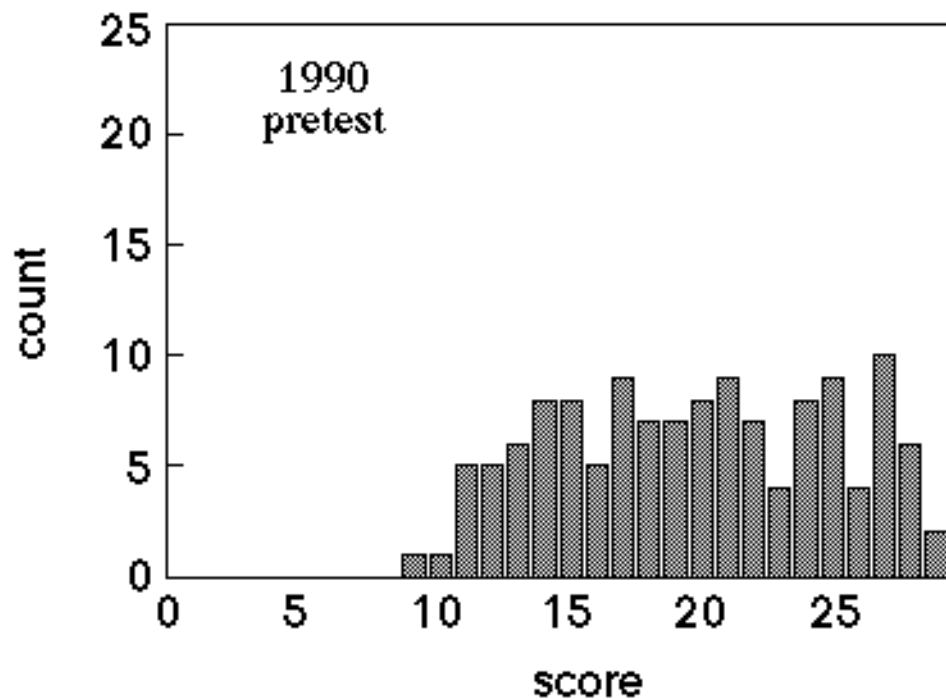

THE CAUSE

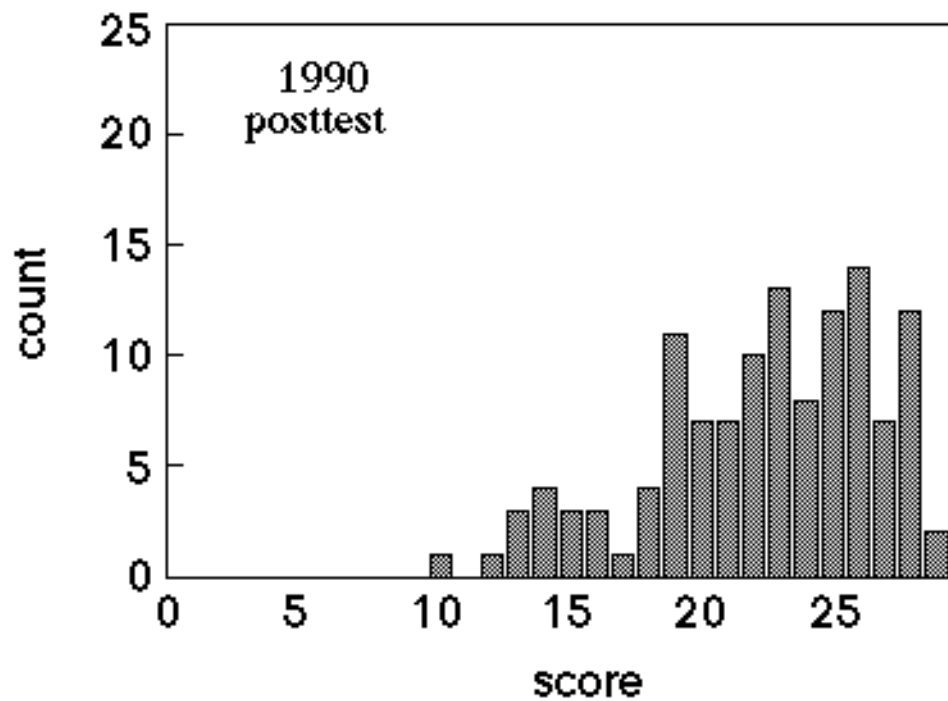

THE CAUSE

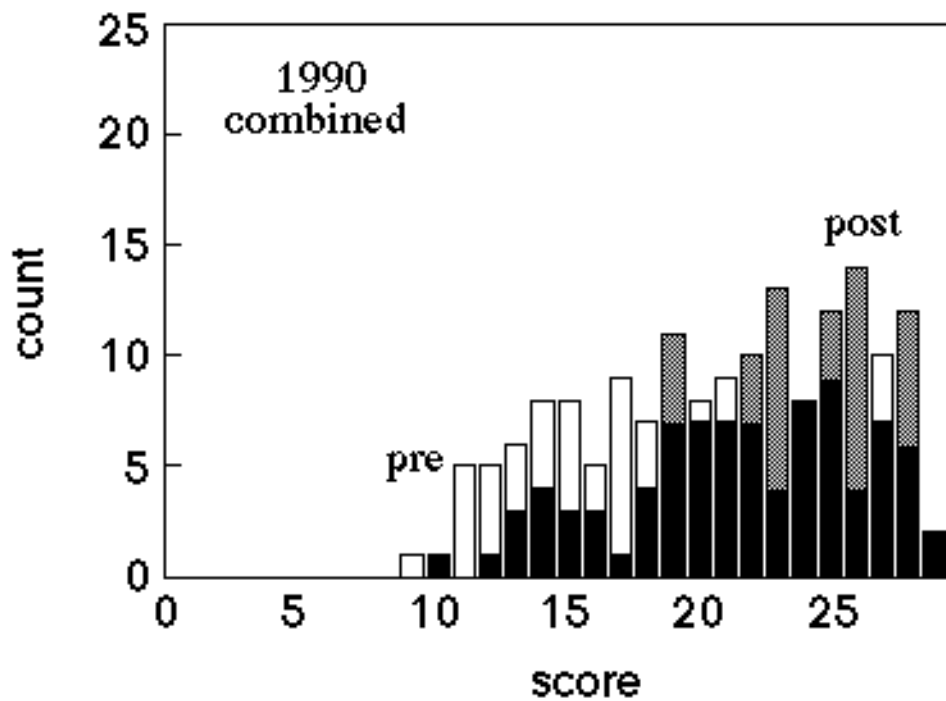

THE CAUSE

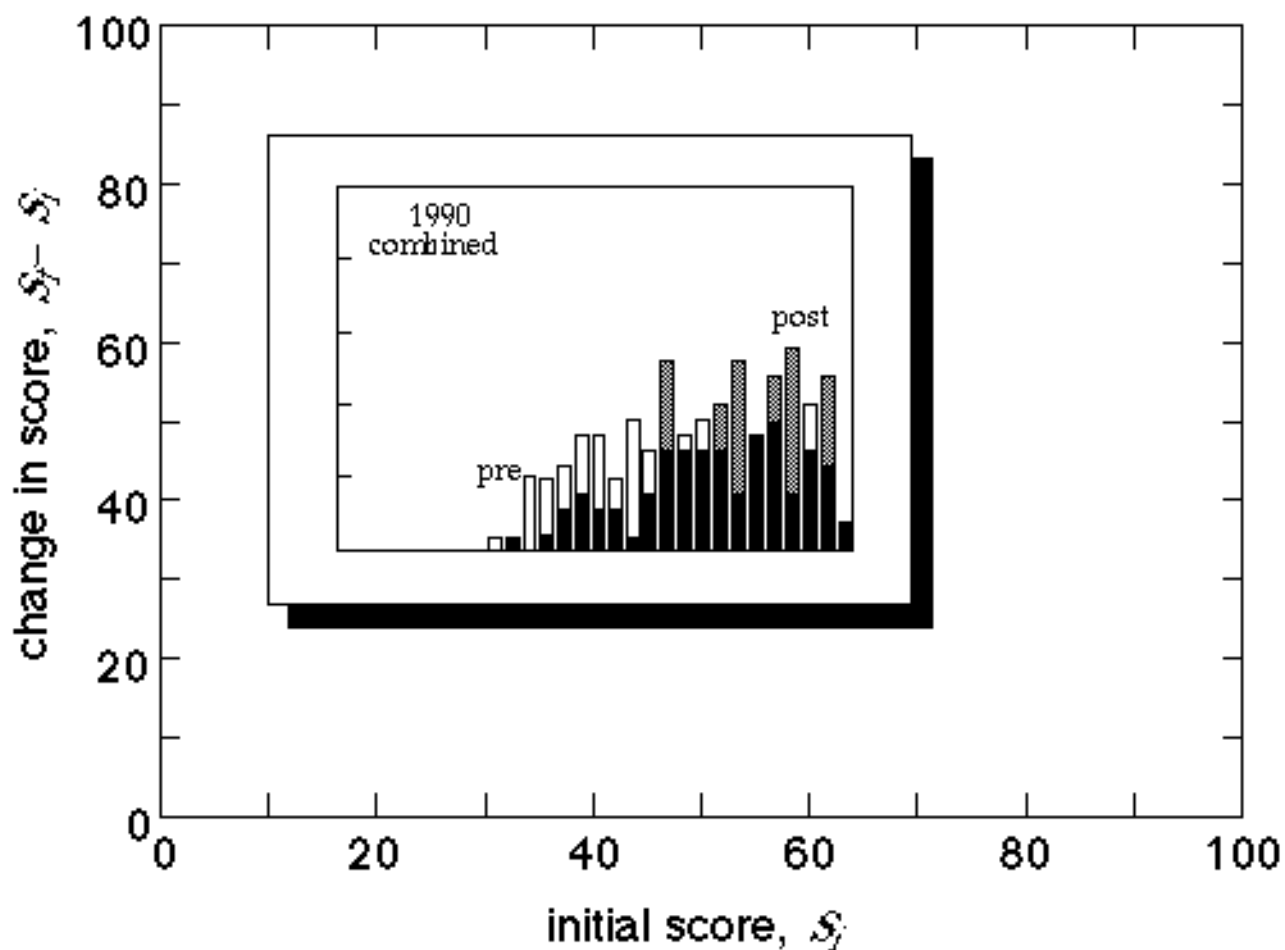

THE CAUSE

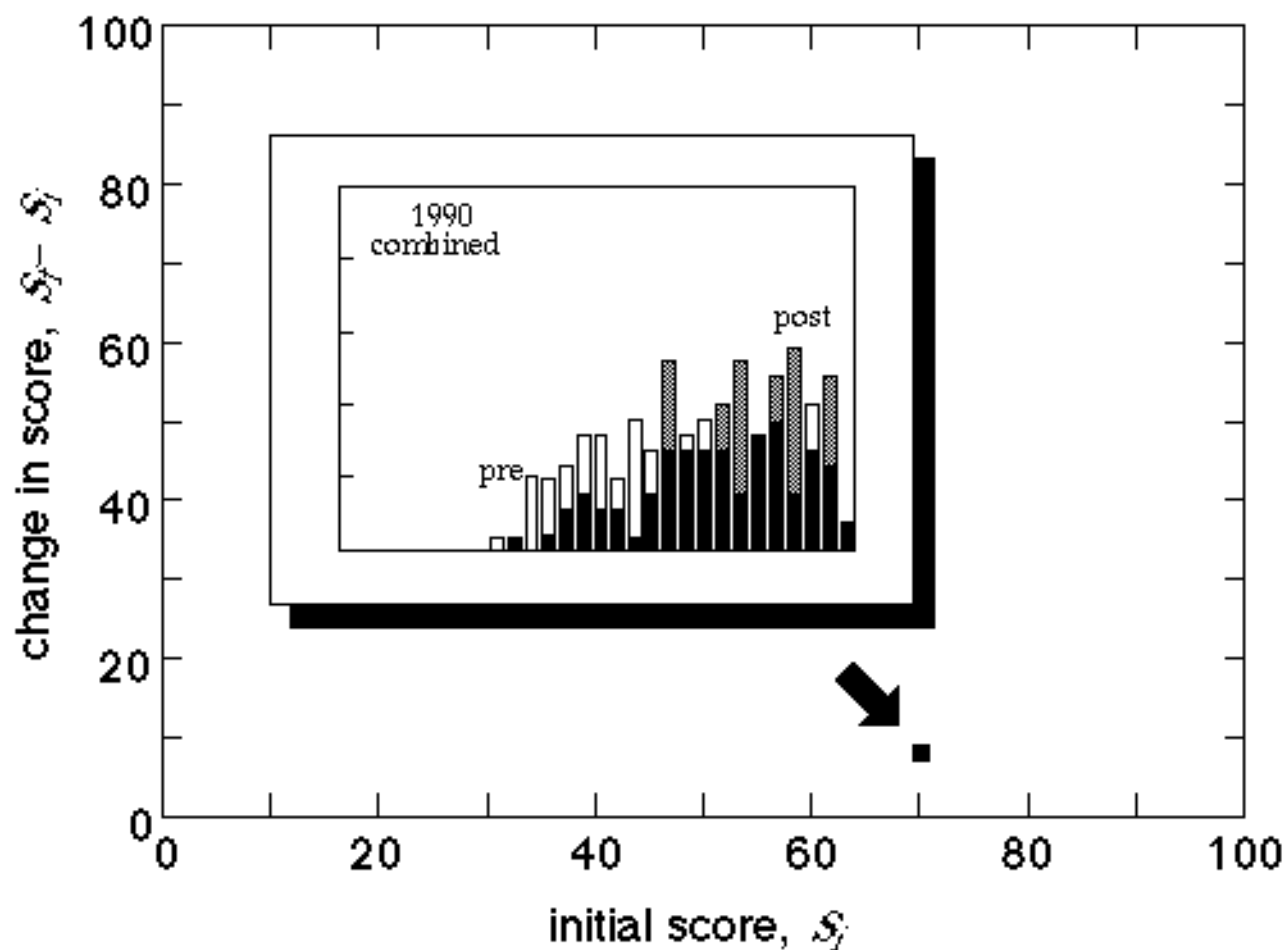

THE CAUSE

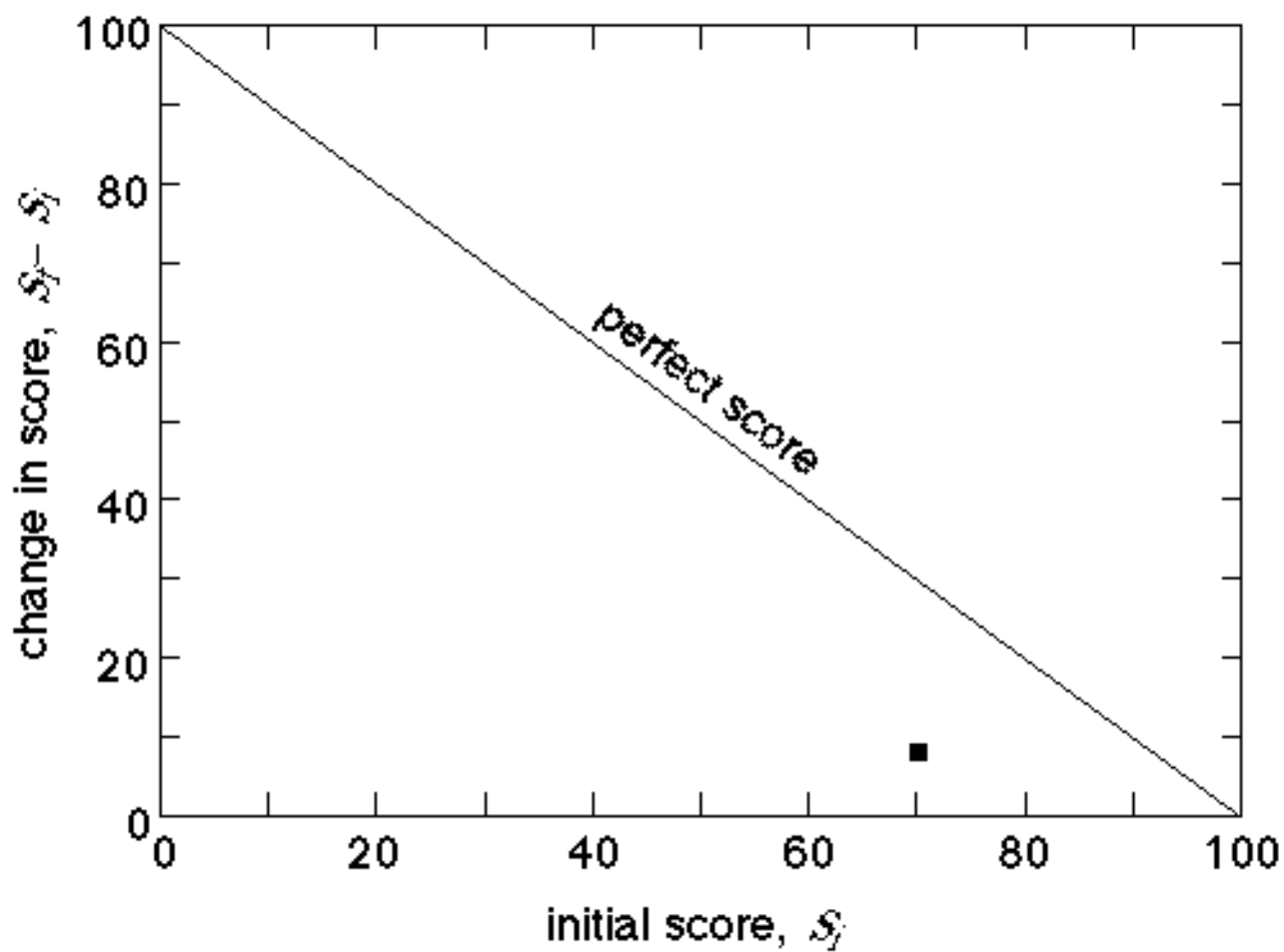

THE CAUSE

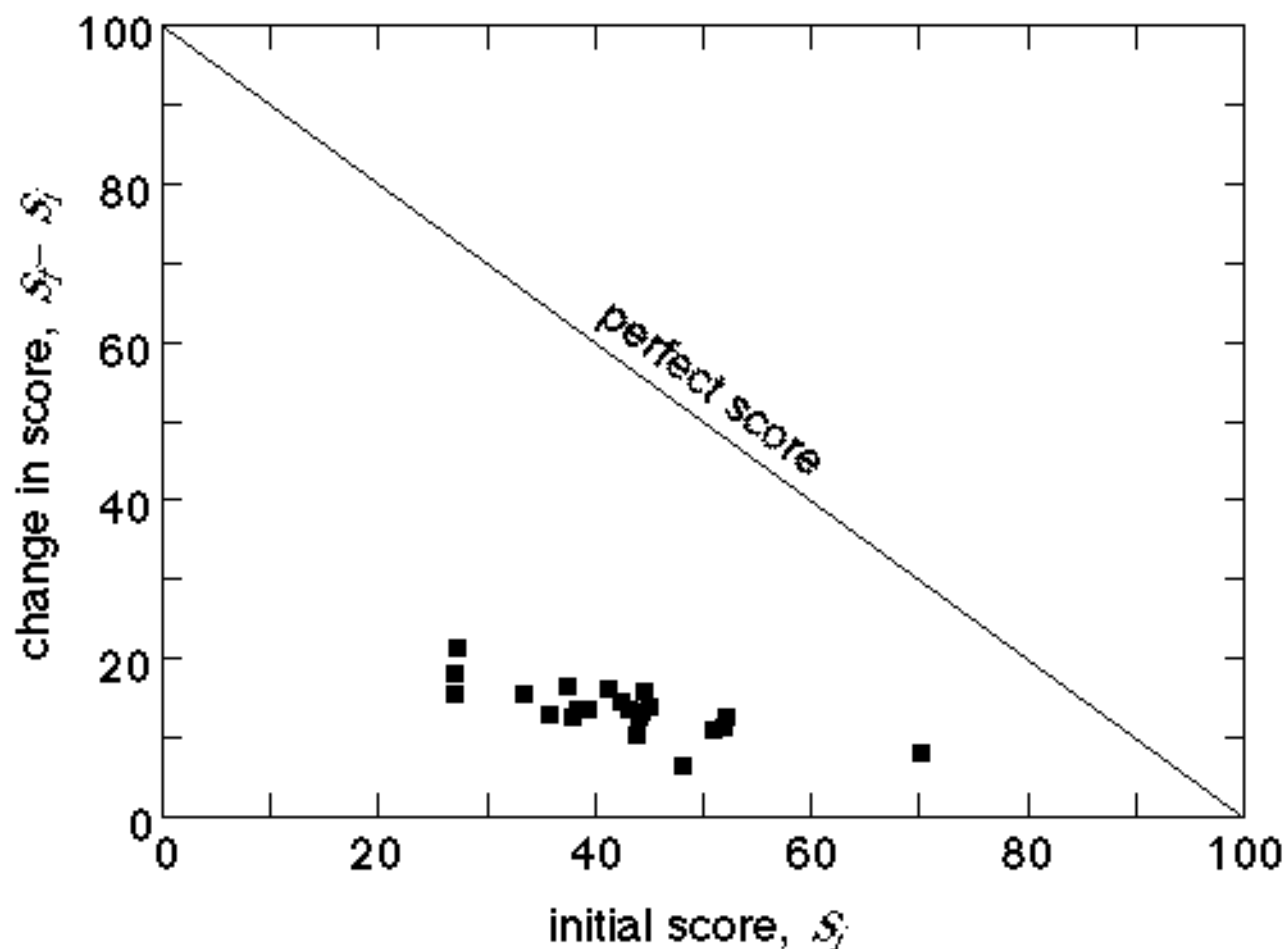

THE CAUSE

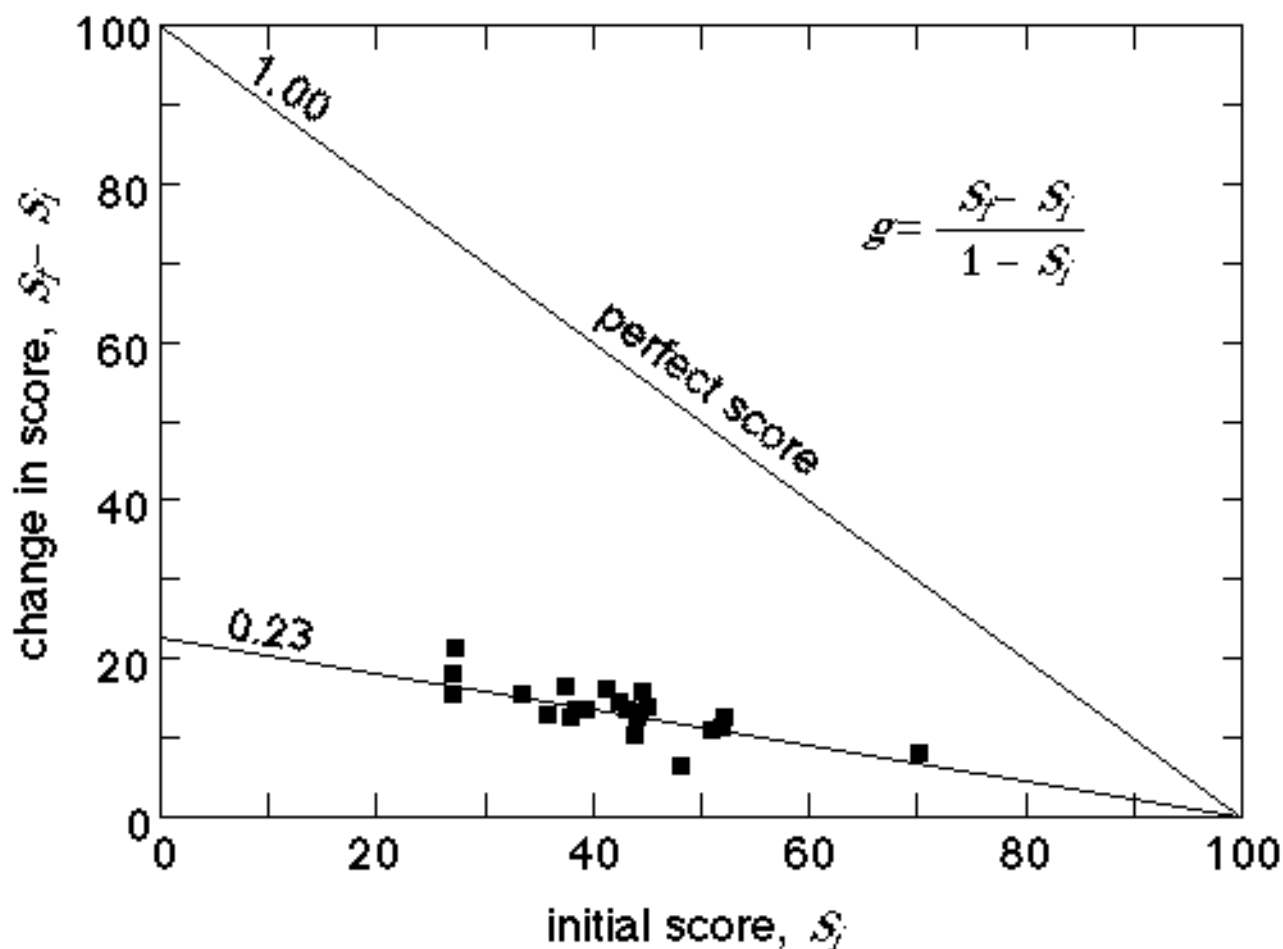

THE CAUSE

2. Conventional problems reinforce bad study habits

Calculate:

- (a) the current in the $2\text{-}\Omega$ resistor, and
- (b) the potential difference between points a and b .

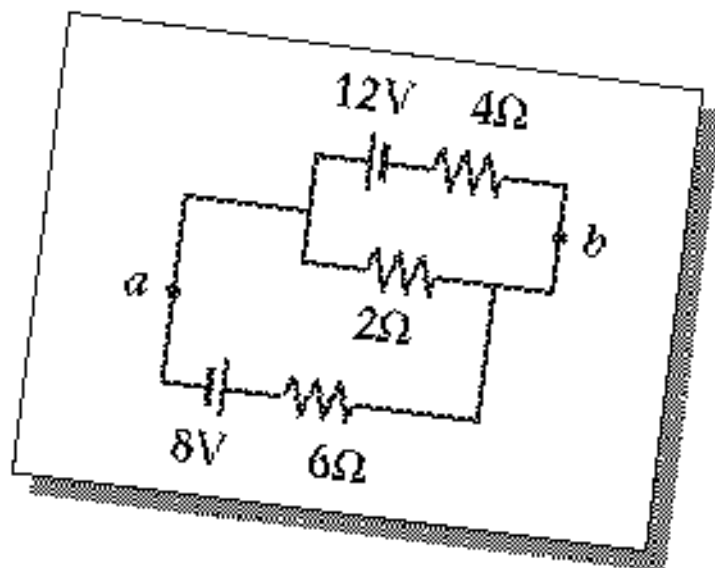

THE CAUSE

Are basic principles understood?

When S is closed, what happens to the:

- (a) intensities of A and B ?
- (b) intensity of C ?
- (c) current through battery?
- (d) voltage drop across A , B , and C ?
- (e) total power dissipated?

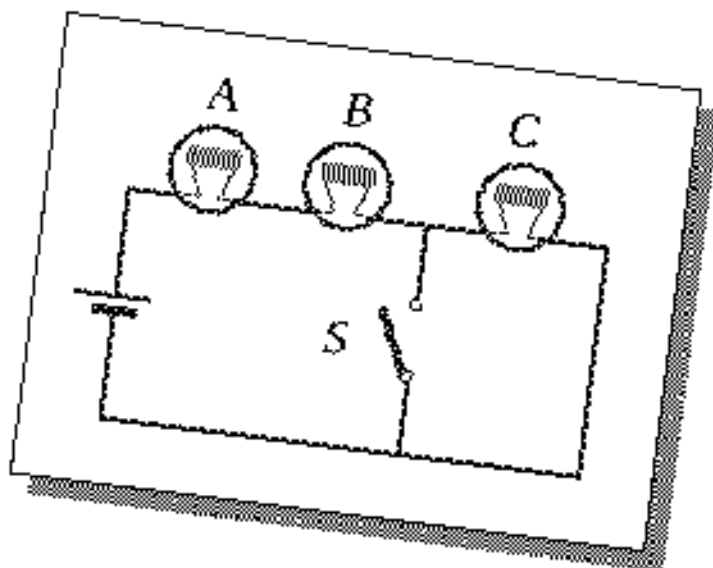

THE CAUSE

conventional

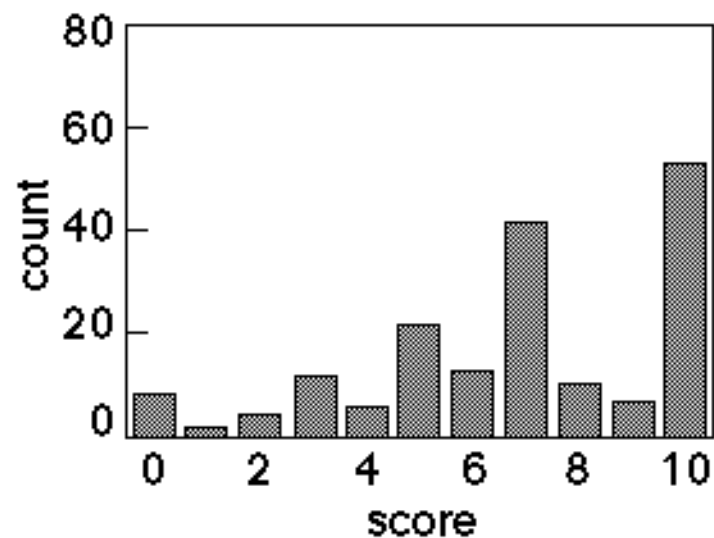

conceptual

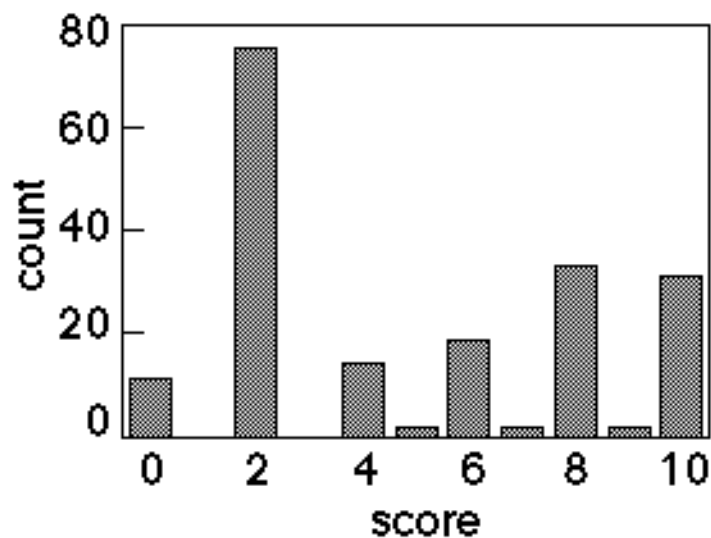

THE CAUSE

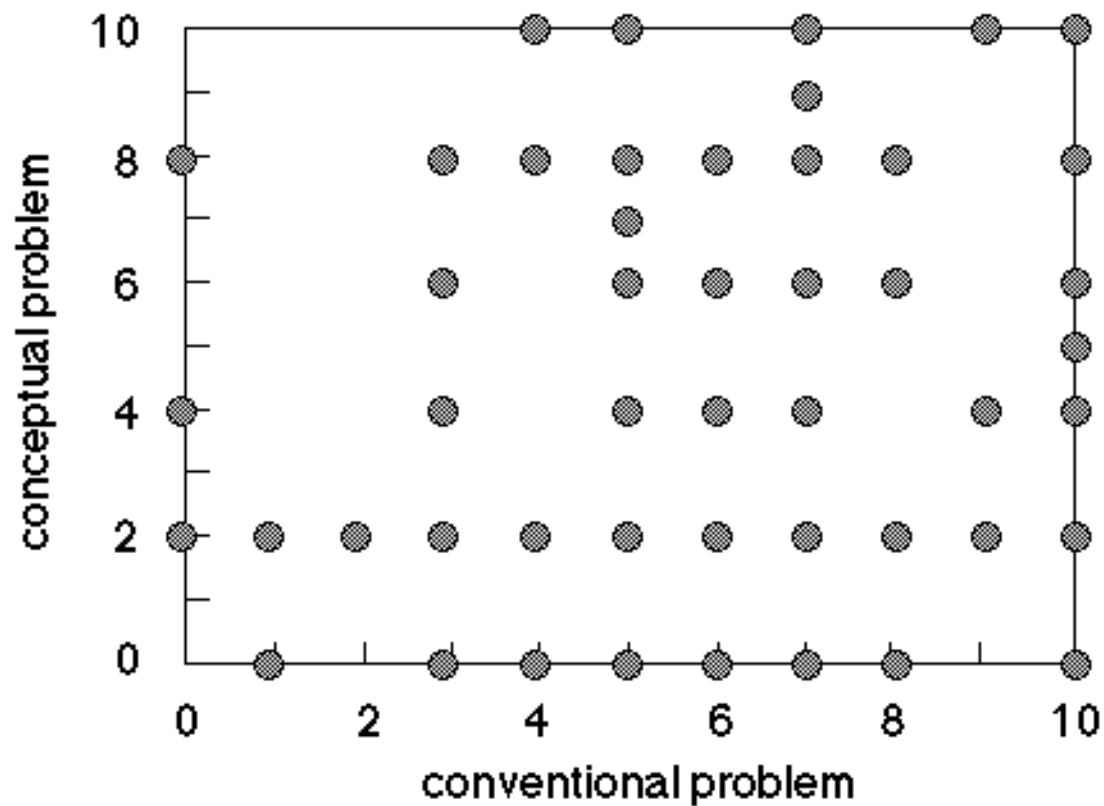

THE CAUSE

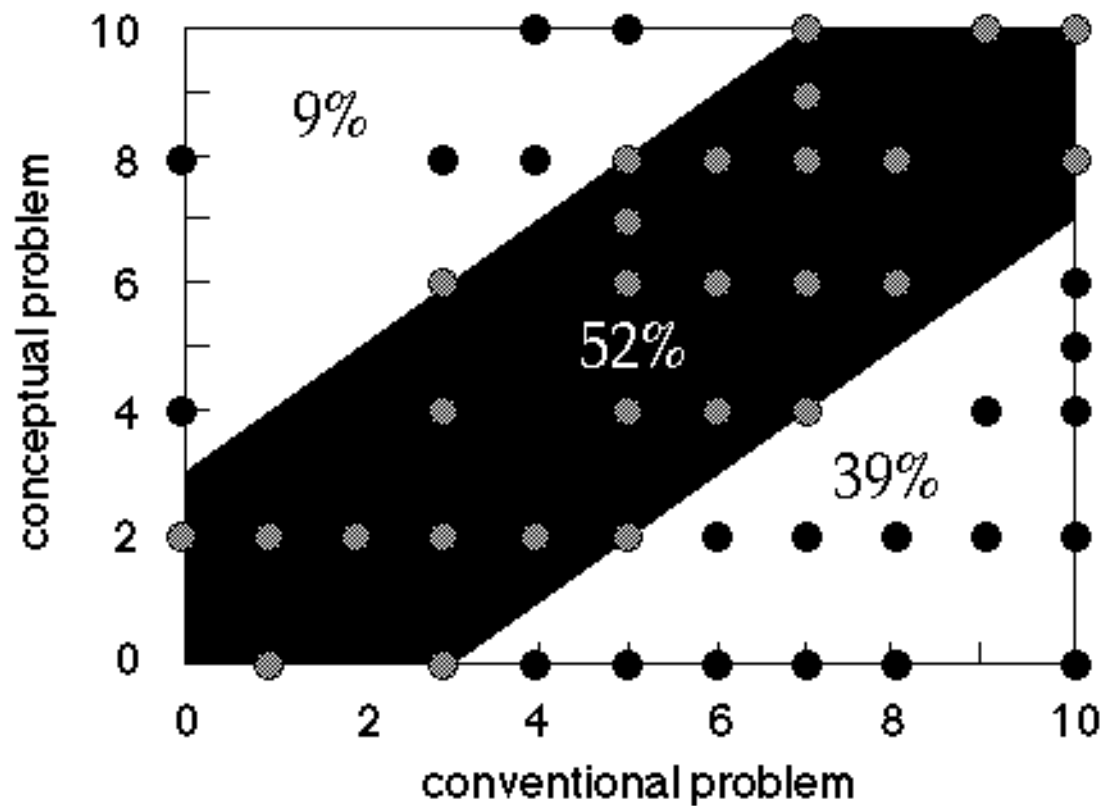

① Problem

② Cause

③ Remedy

PEER INSTRUCTION

Give students more responsibility for learning!



PEER INSTRUCTION

1. Recognize the inefficacy of the lecture method!

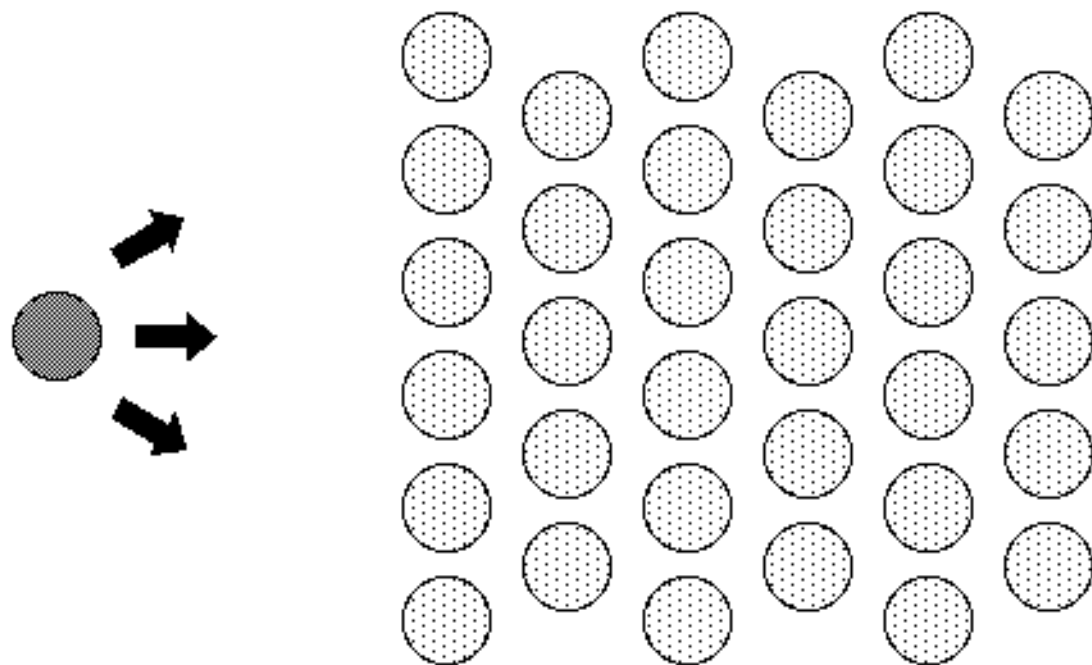

PEER INSTRUCTION

1. Recognize the inefficacy of the lecture method!

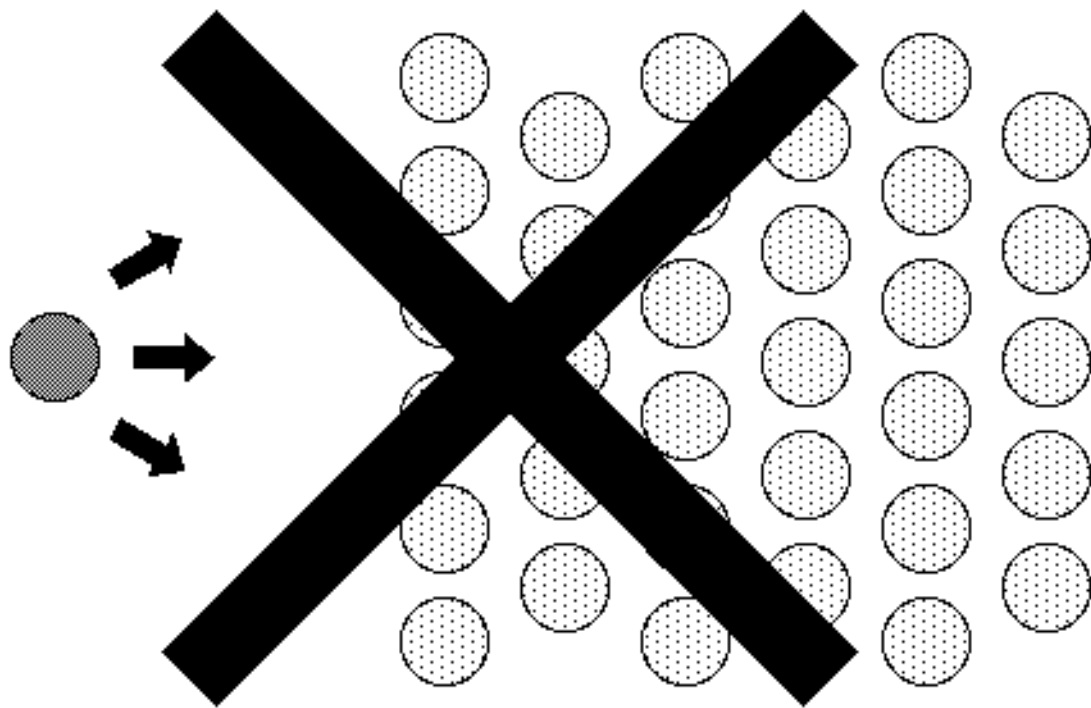

PEER INSTRUCTION

2. Move first exposure to material **out of classroom**

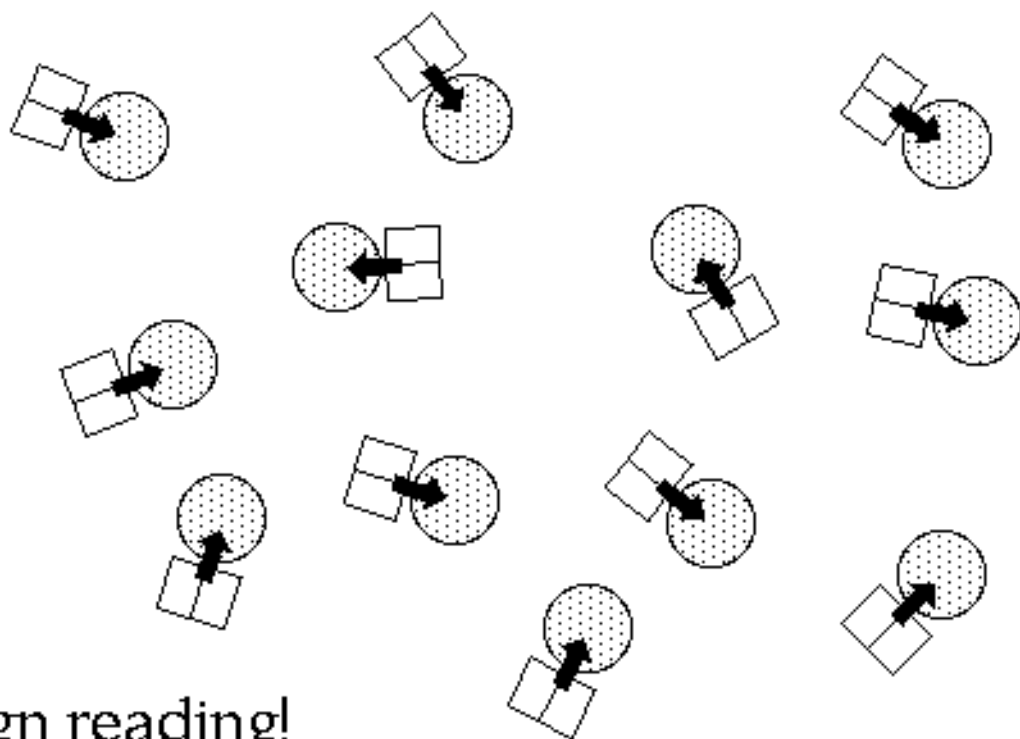

...assign reading!



PEER INSTRUCTION

3. Use class to deepen and broaden understanding



PEER INSTRUCTION

... by transferring some **additional** information ...

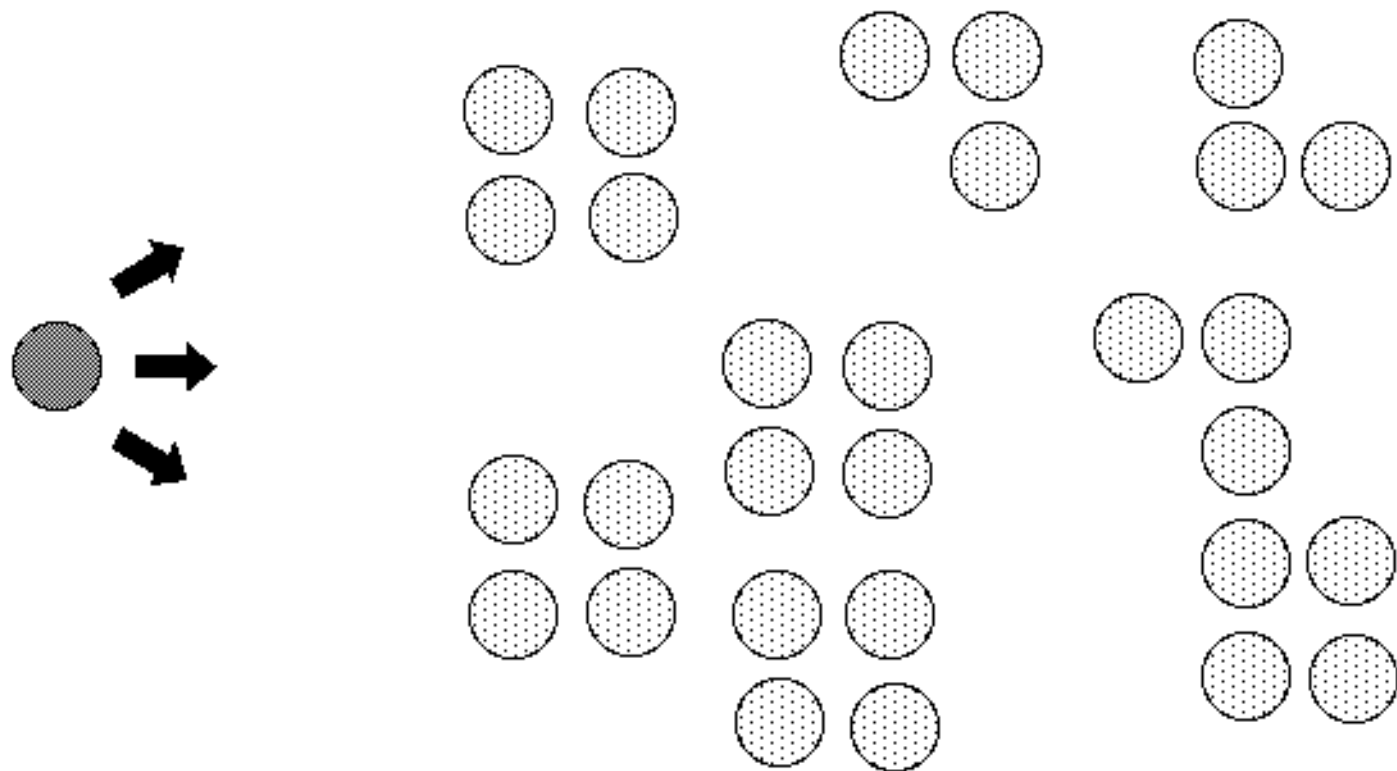

PEER INSTRUCTION

... and by giving students opportunities to **think**.

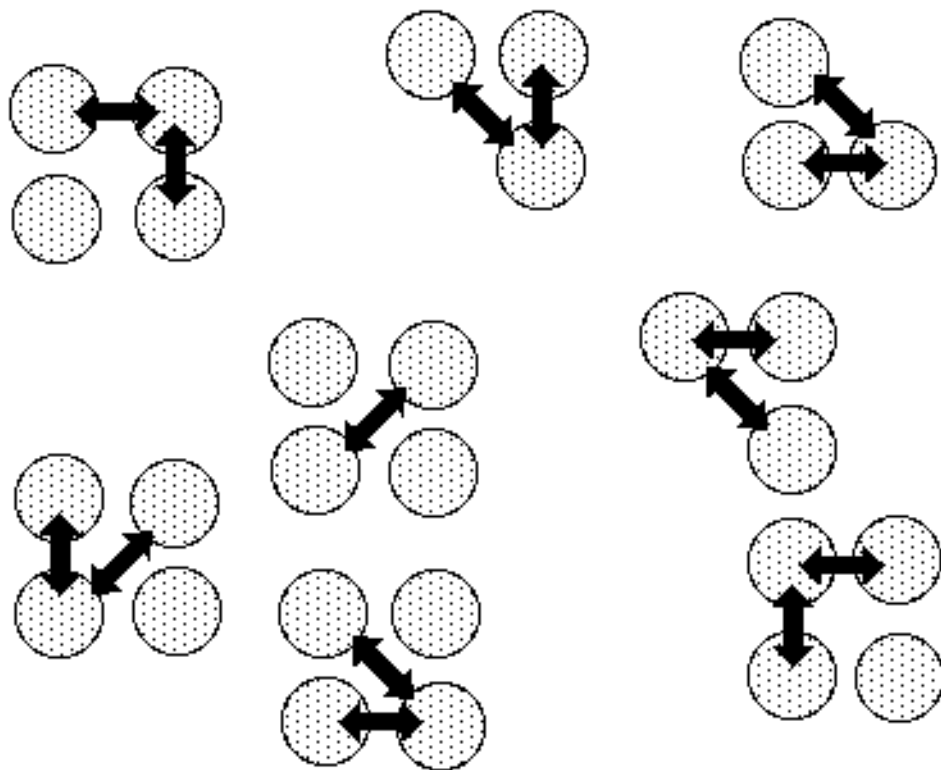
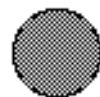

PEER INSTRUCTION

Better yet: **Learn from your students ...**

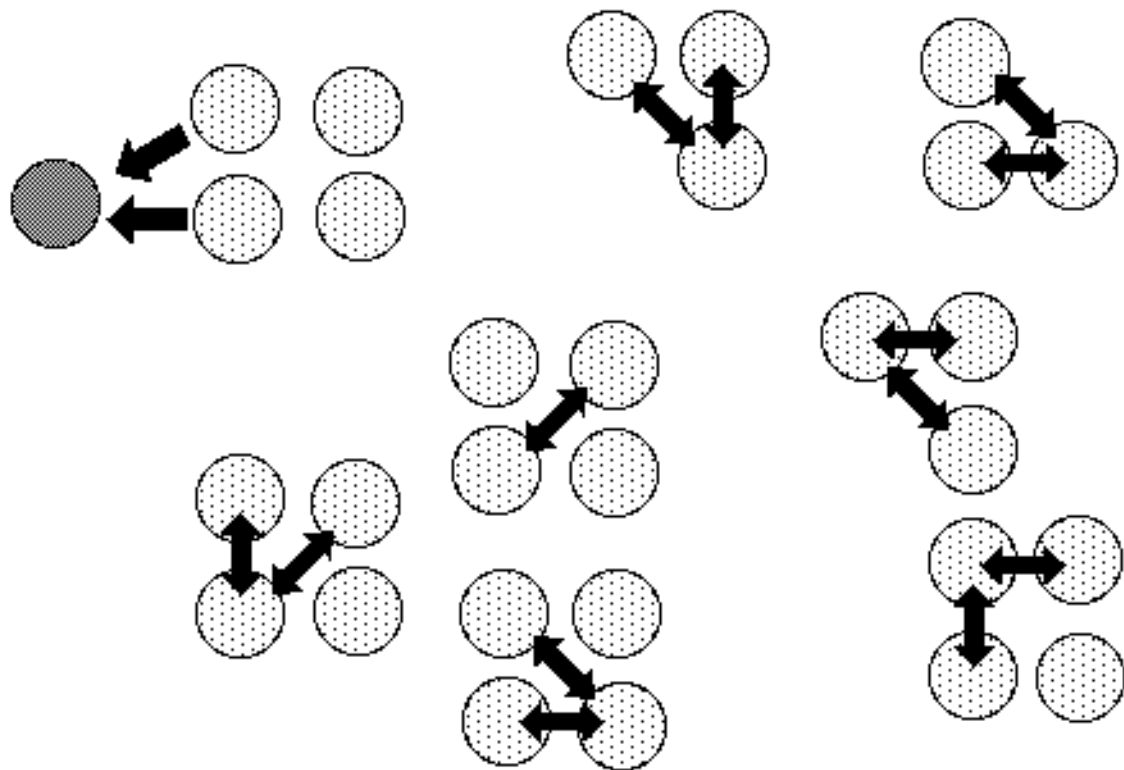

PEER INSTRUCTION

Better yet: **Learn from your students ...**

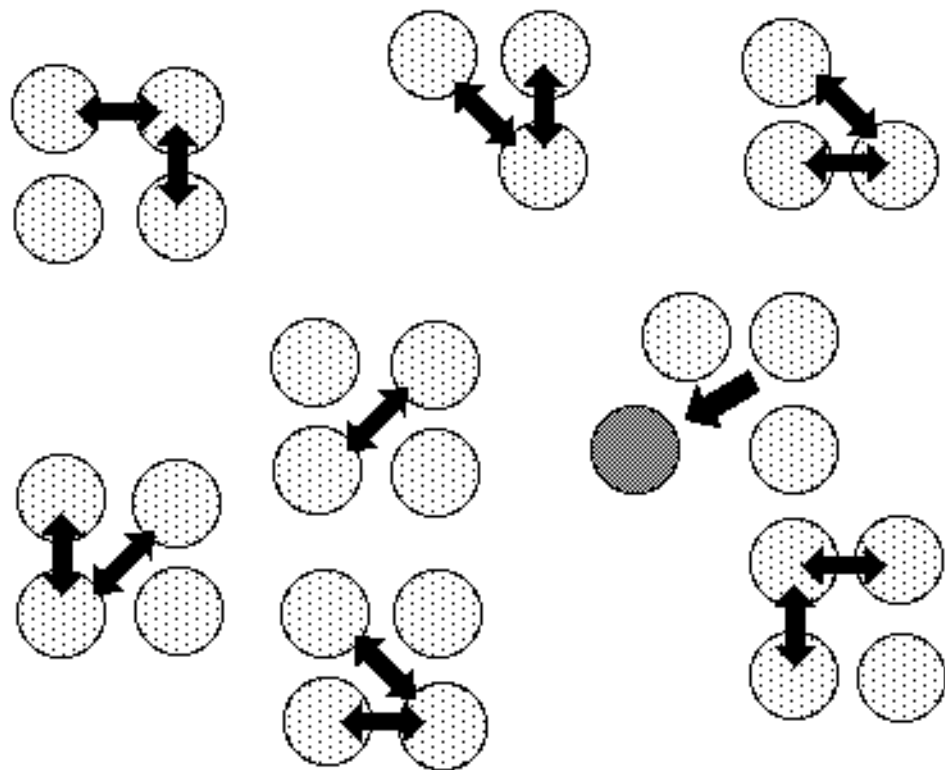

PEER INSTRUCTION

Better yet: **Learn from your students ...**

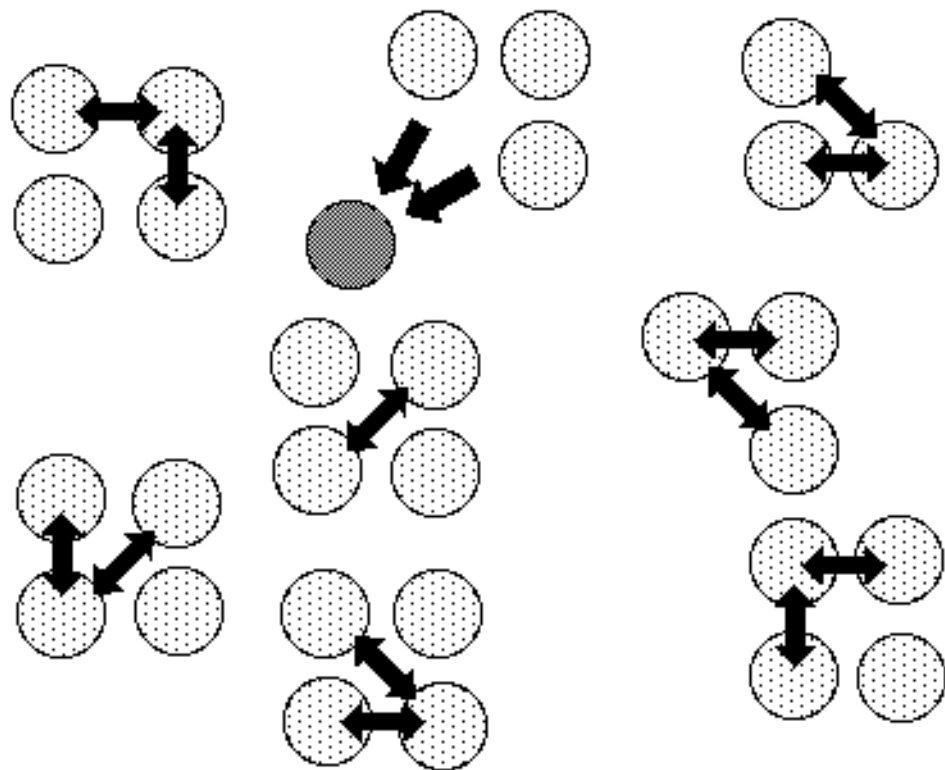

PEER INSTRUCTION

... bring in your **Teaching Assistants** too...!

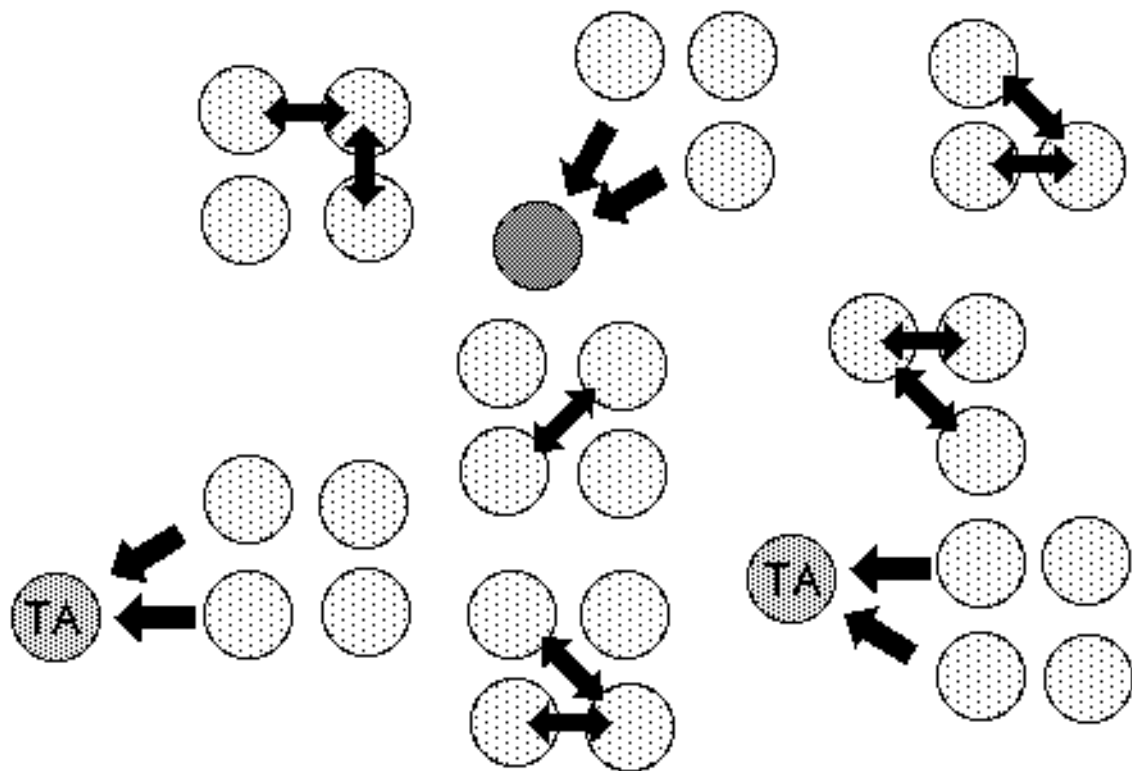

Main features:

- Pre-class reading
- In class: depth, not coverage
- ConcepTests



CONCEPTEST

1. Question
2. Thinking
3. Individual answer
4. Peer discussion
5. Group answer
6. Explanation



CONCEPTEST

1. Question
2. Thinking
3. Individual answer
4. Peer discussion
5. Group answer
6. Explanation

CONCEPTEST



CONCEPTTEST

Individual answers

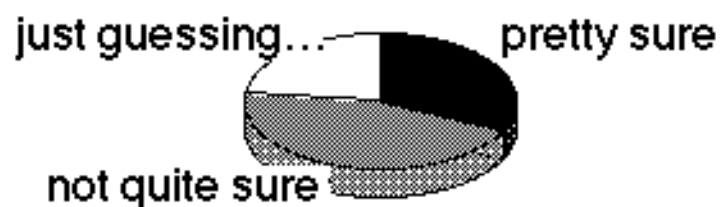
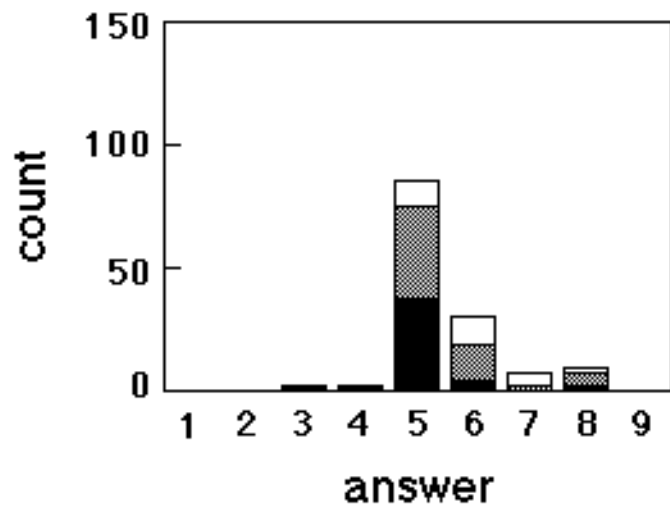

CONCEPTTEST

Group answers

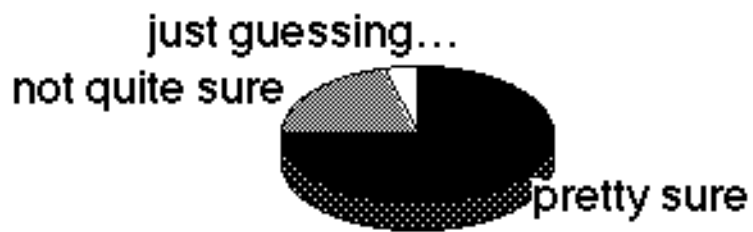
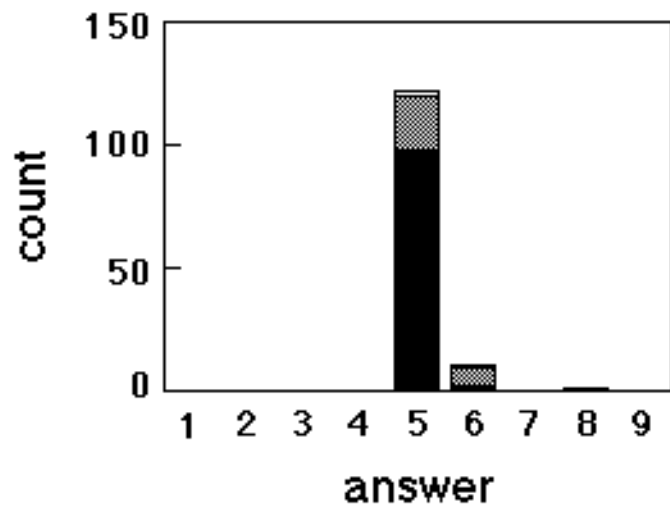

CONCEPTTEST

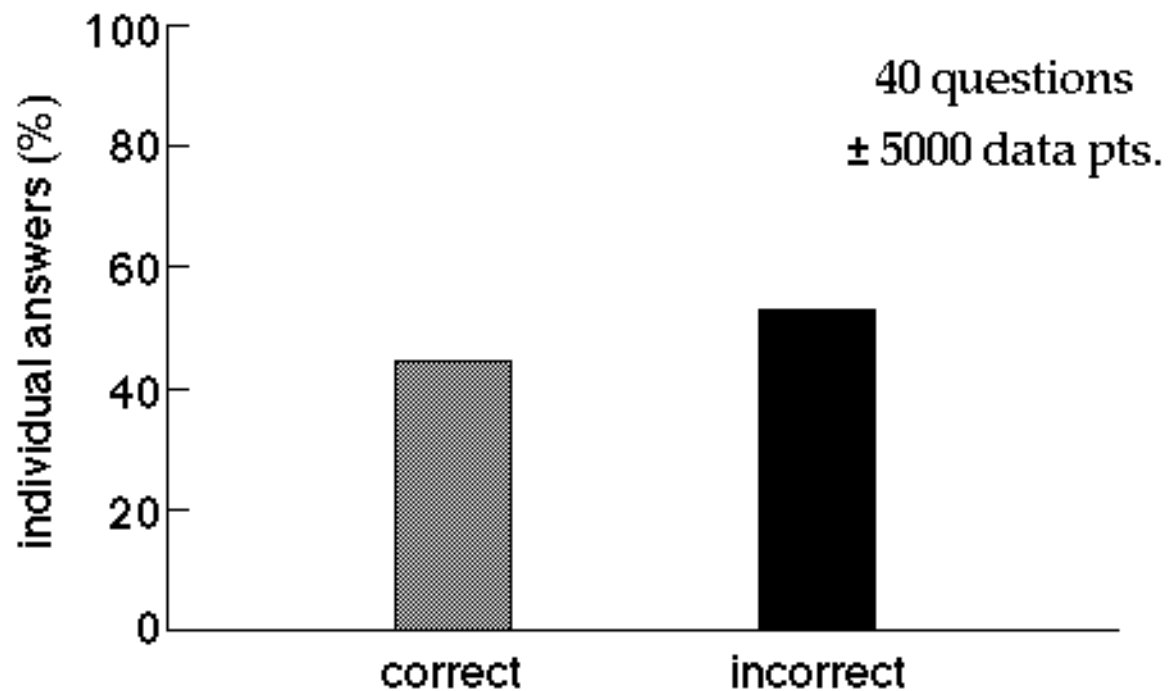

CONCEPTTEST

Students converge on correct answer!

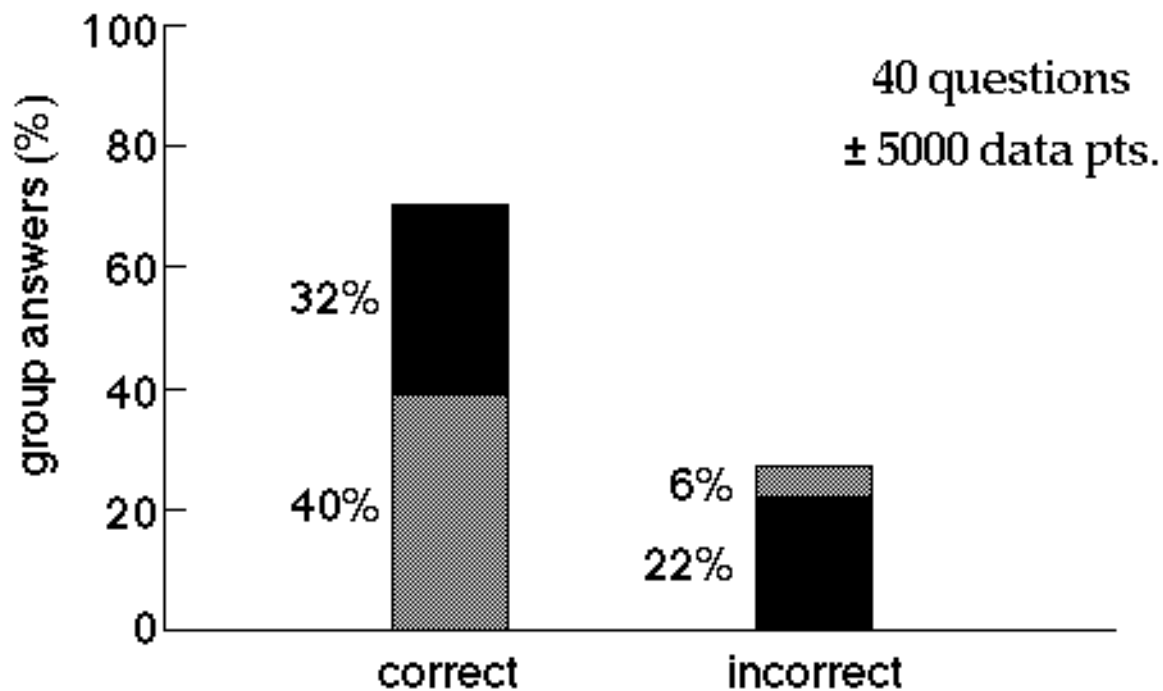

CONCEPTEST

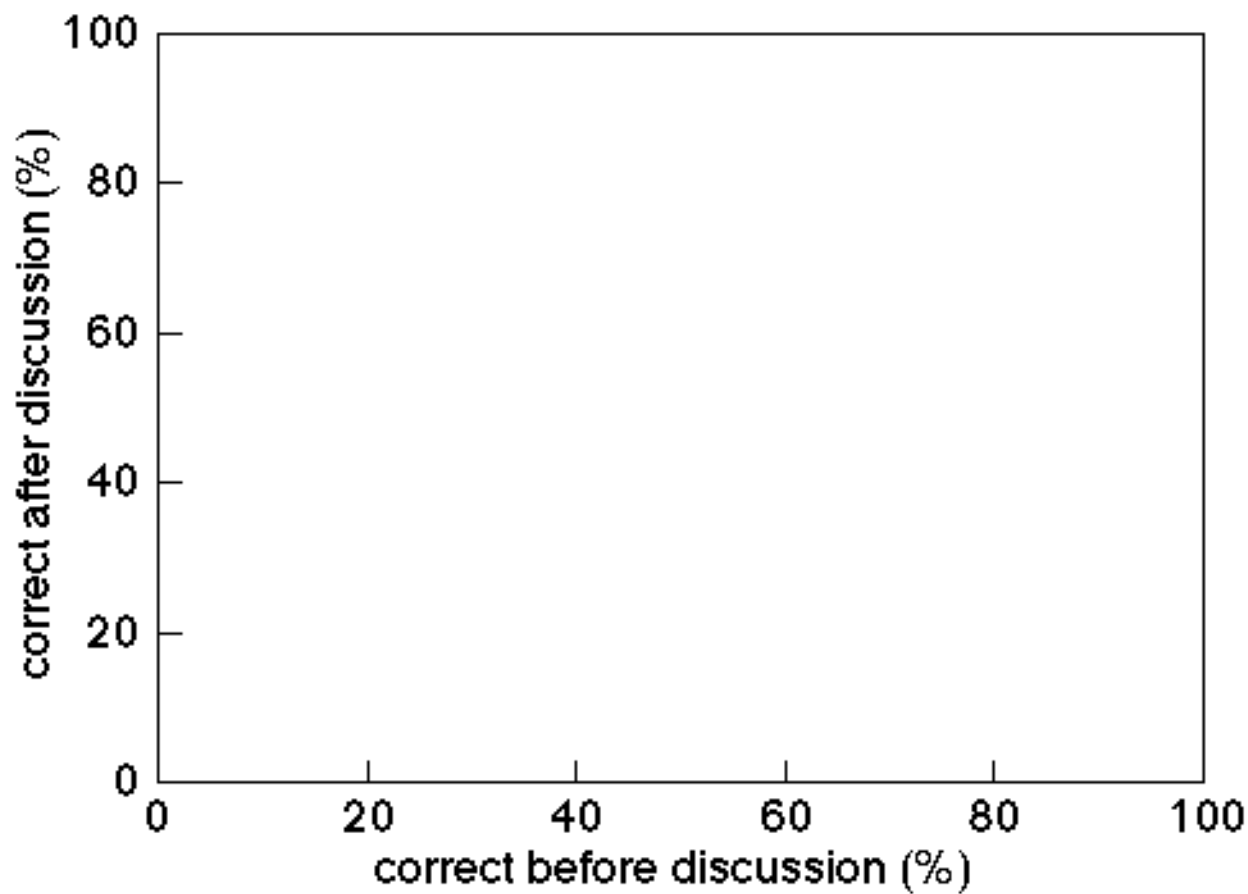

CONCEPTEST

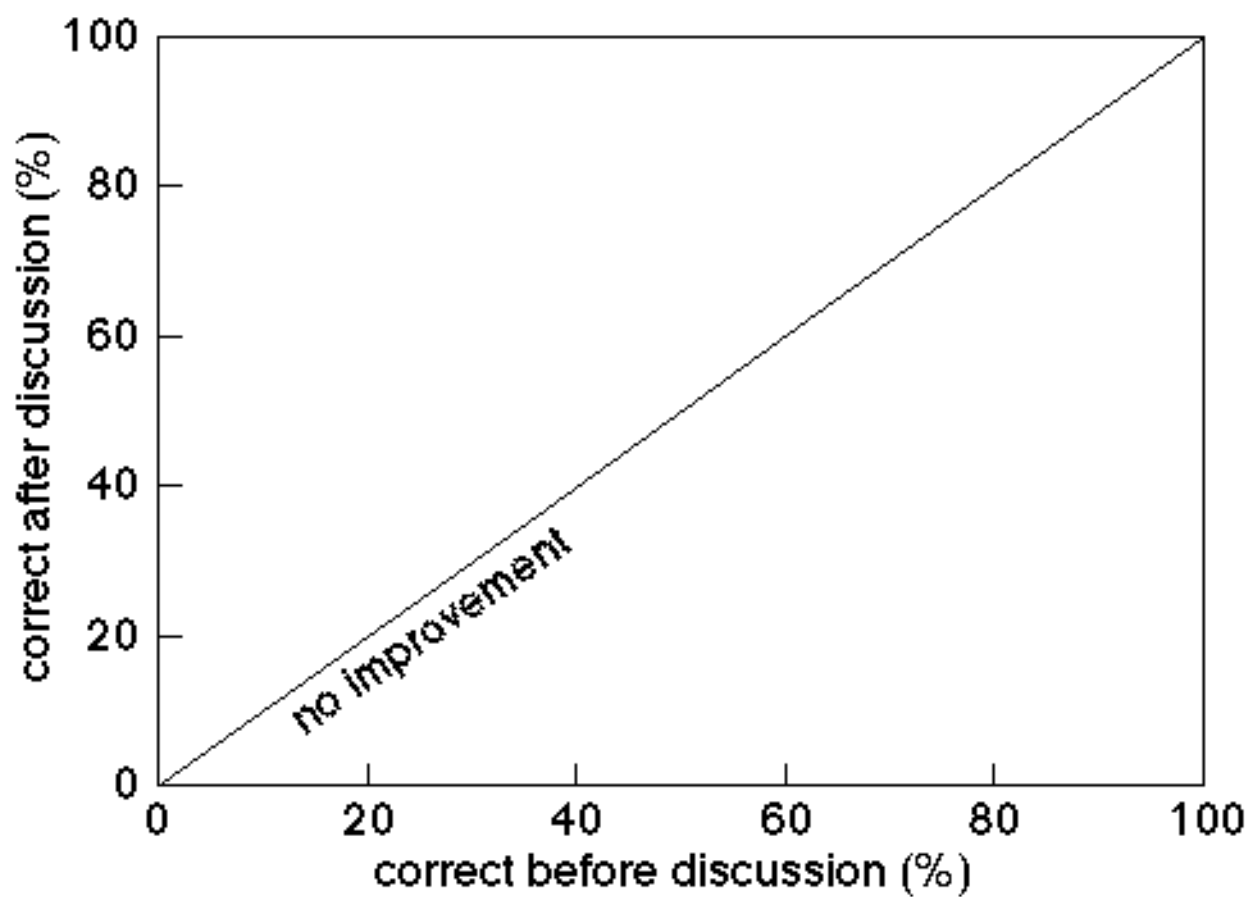

CONCEPTEST

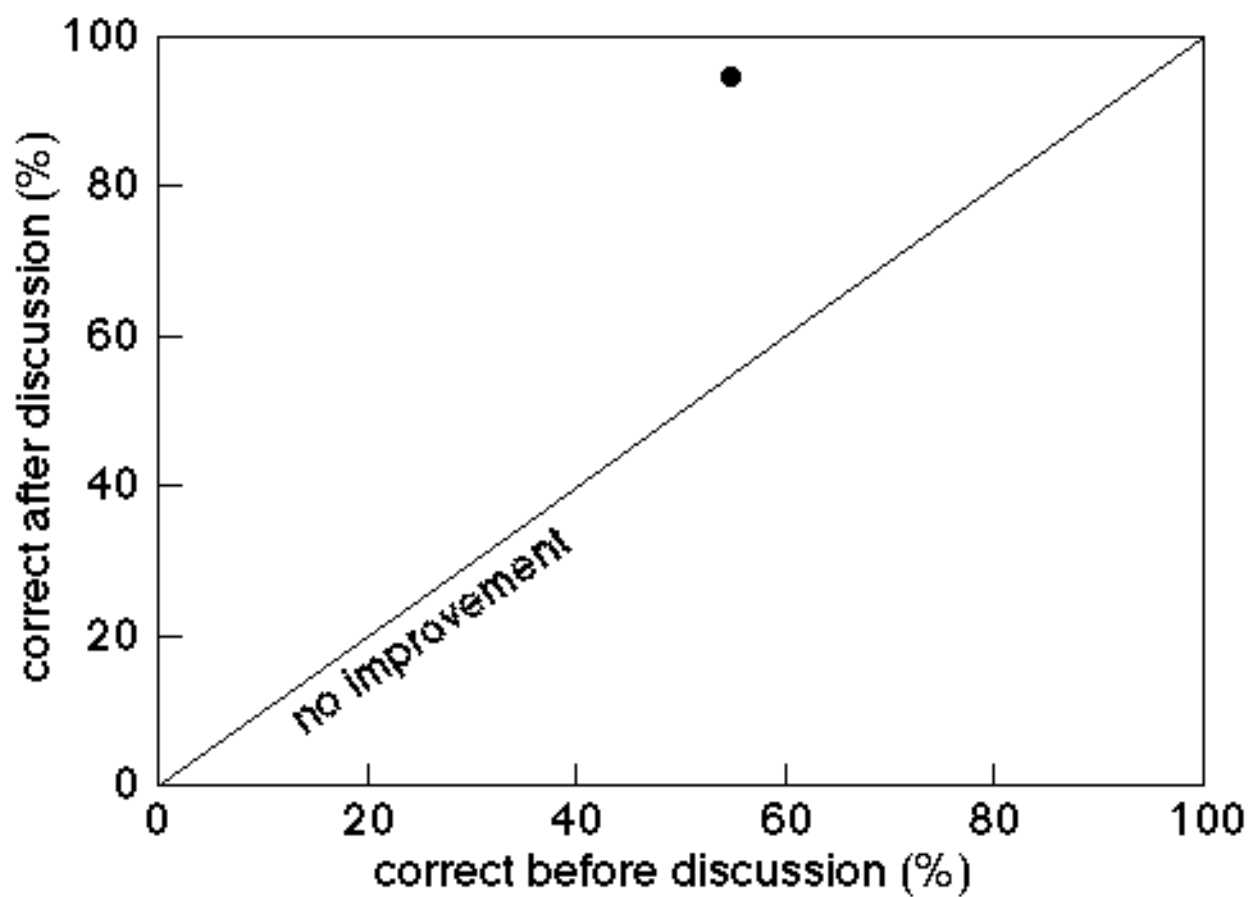

CONCEPTTEST

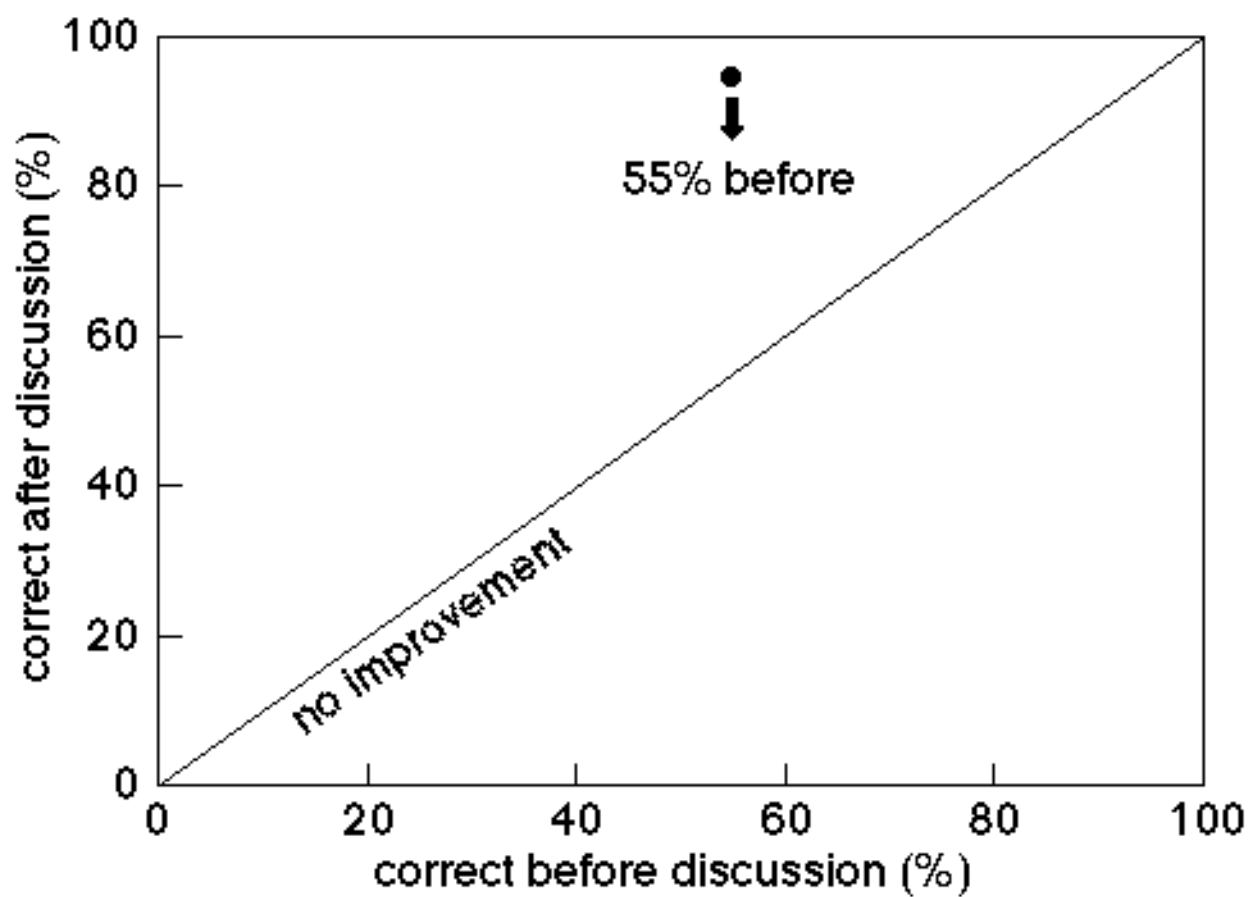

CONCEPTTEST

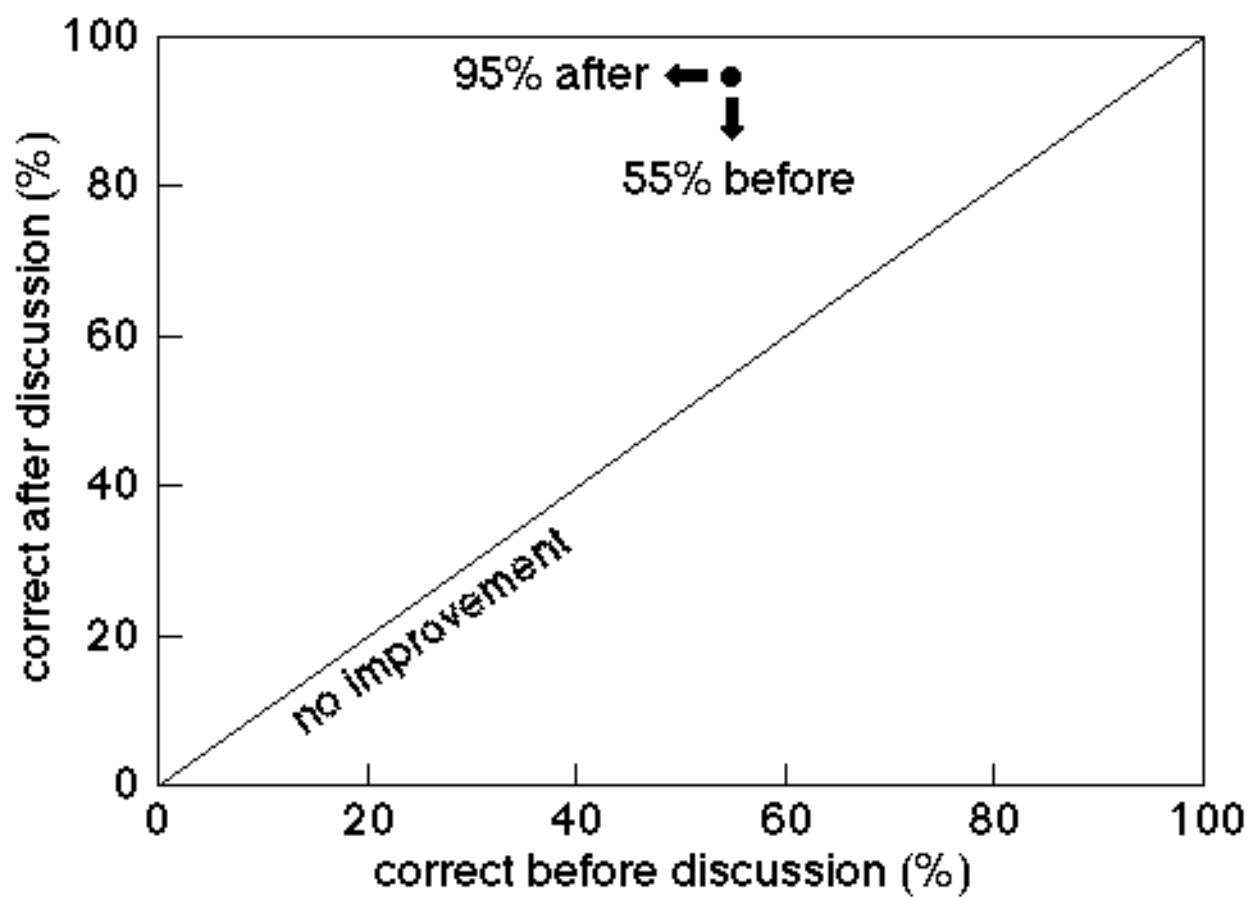

CONCEPTTEST

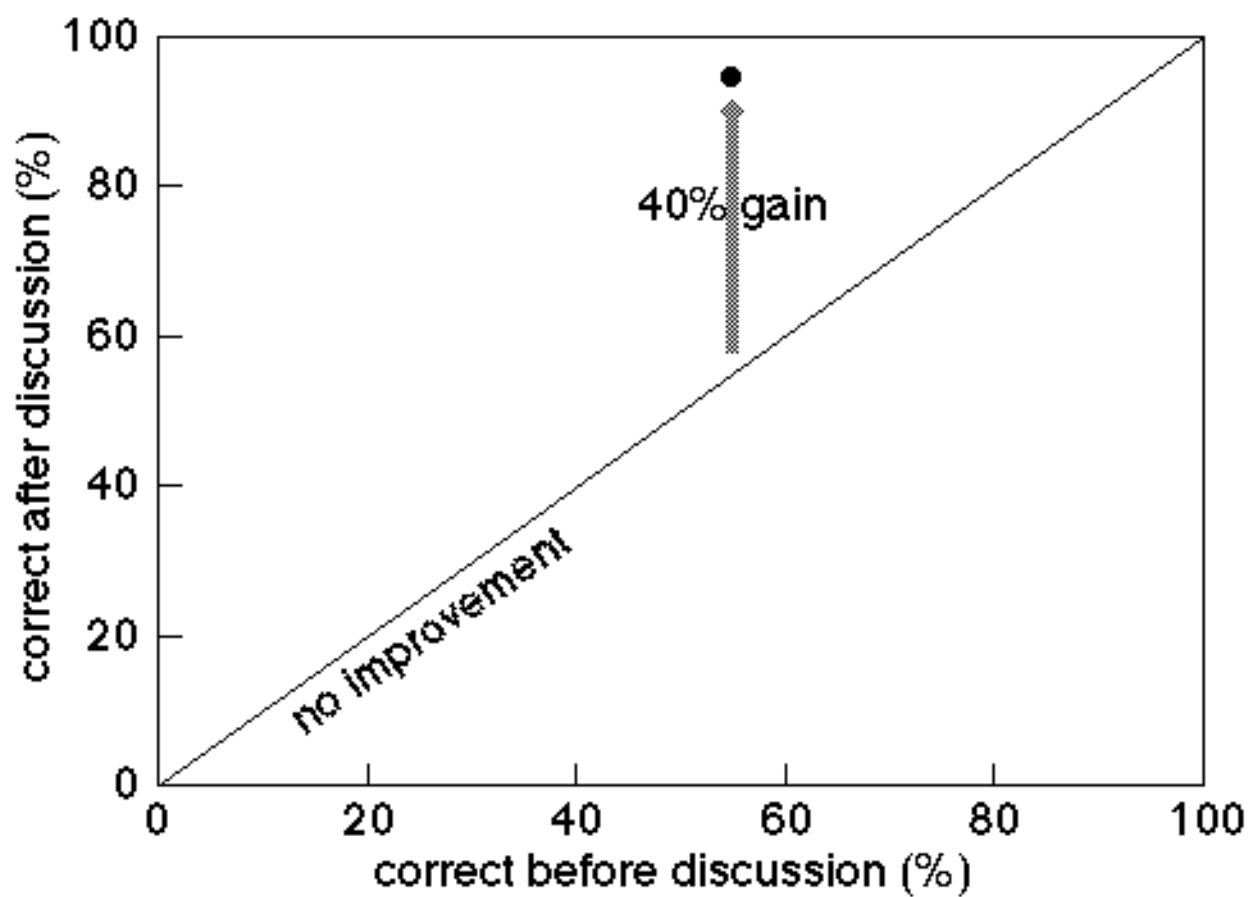

CONCEPTEST

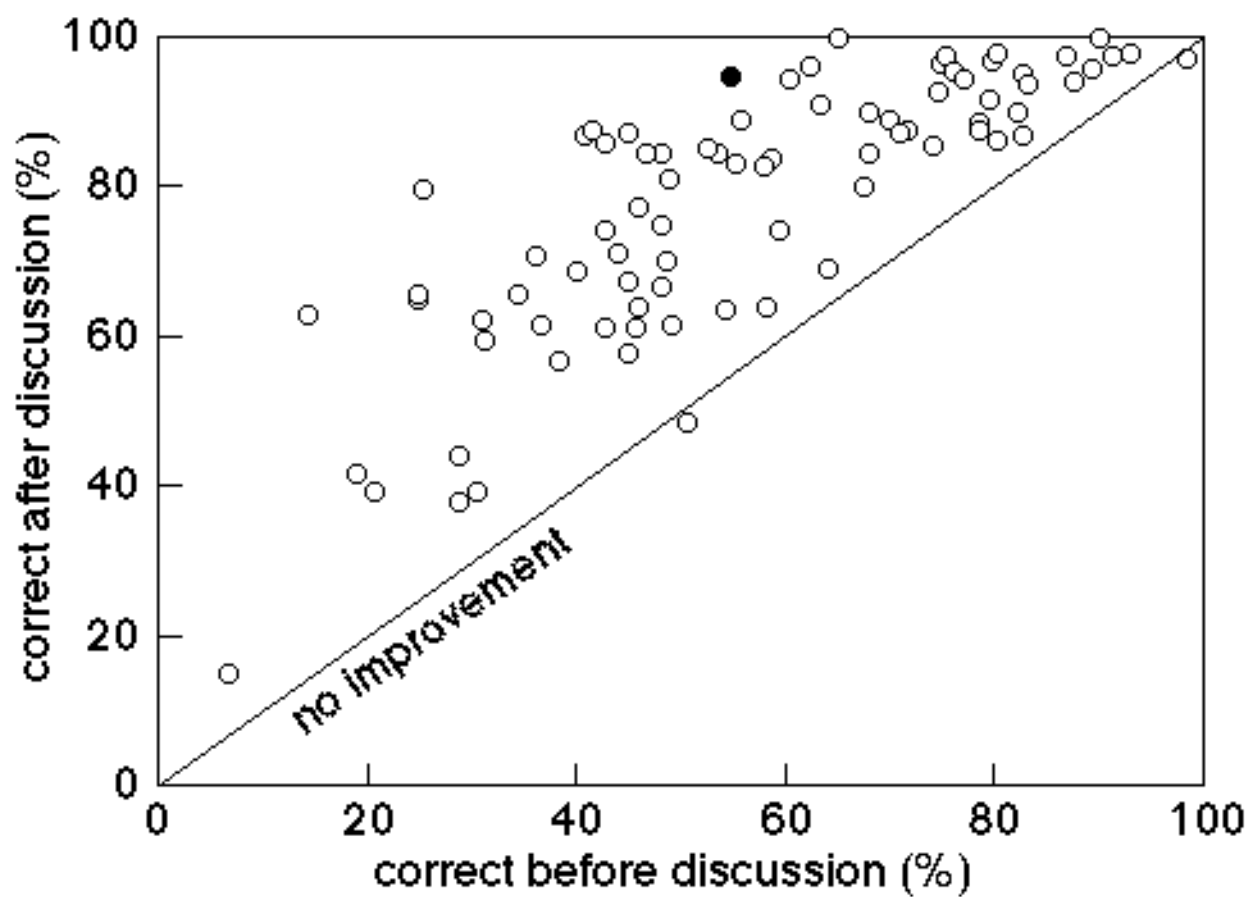

CONCEPTEST

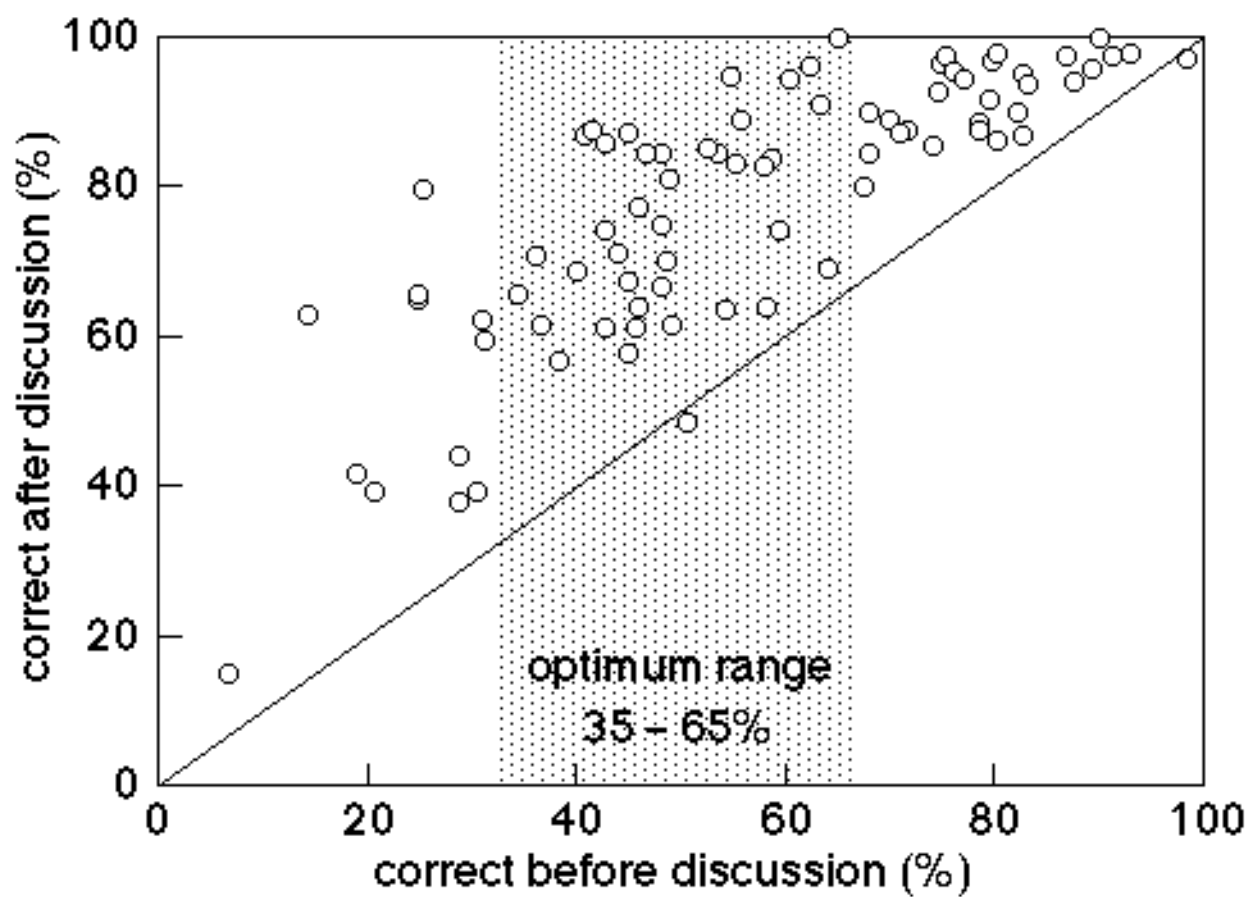



Is it any good...?

RESULTS

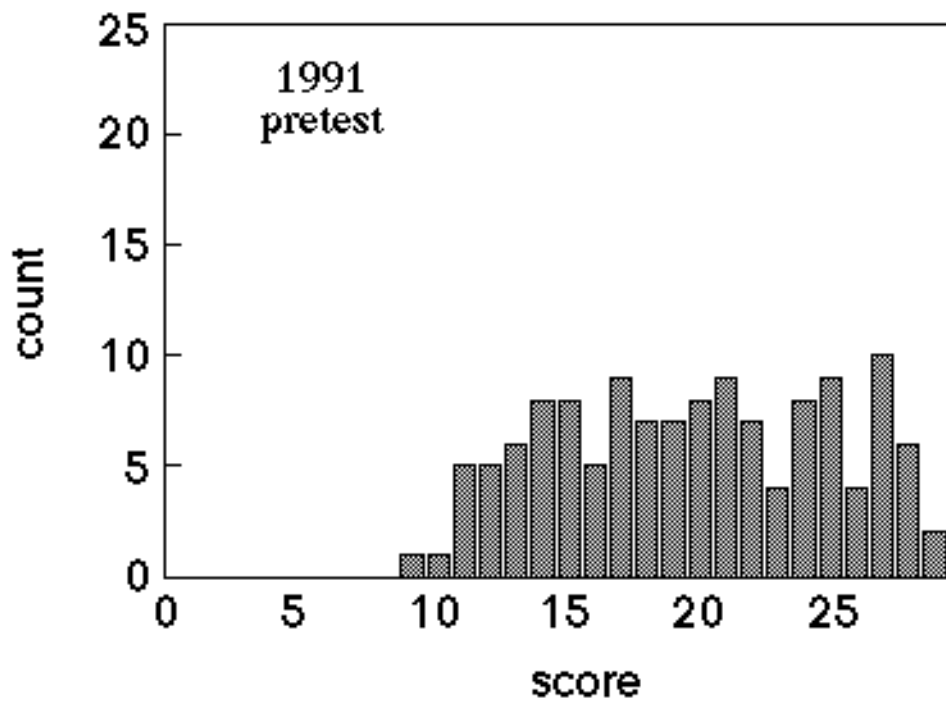

RESULTS

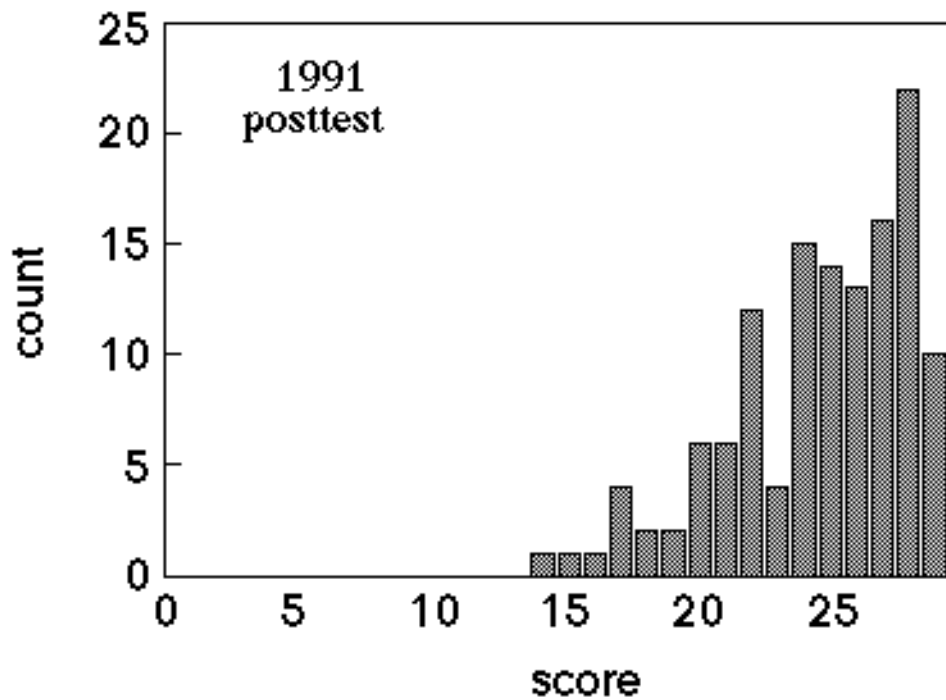

RESULTS

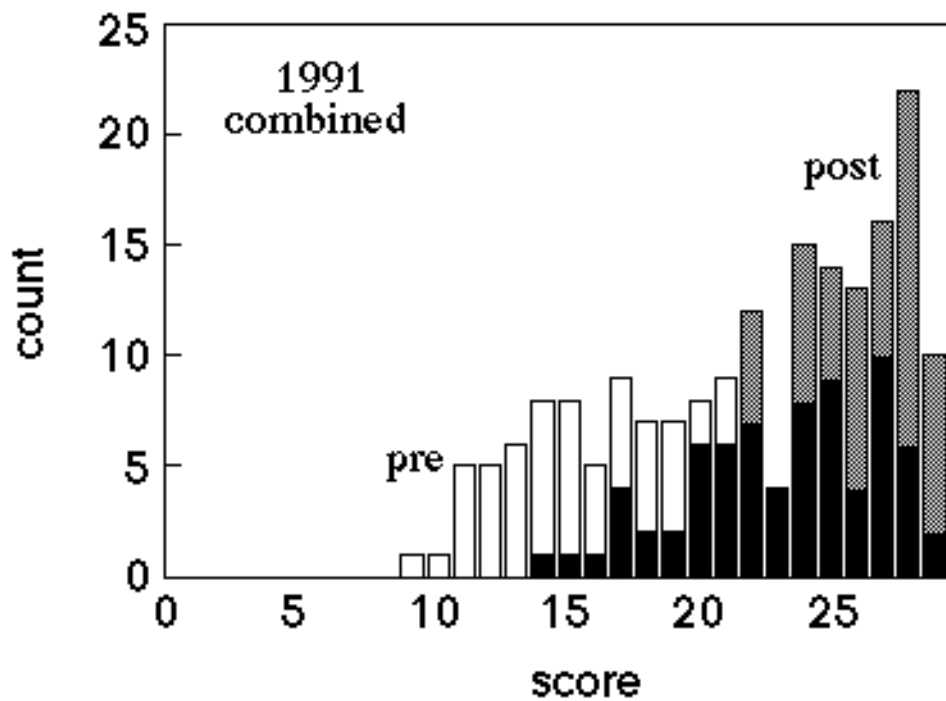

RESULTS

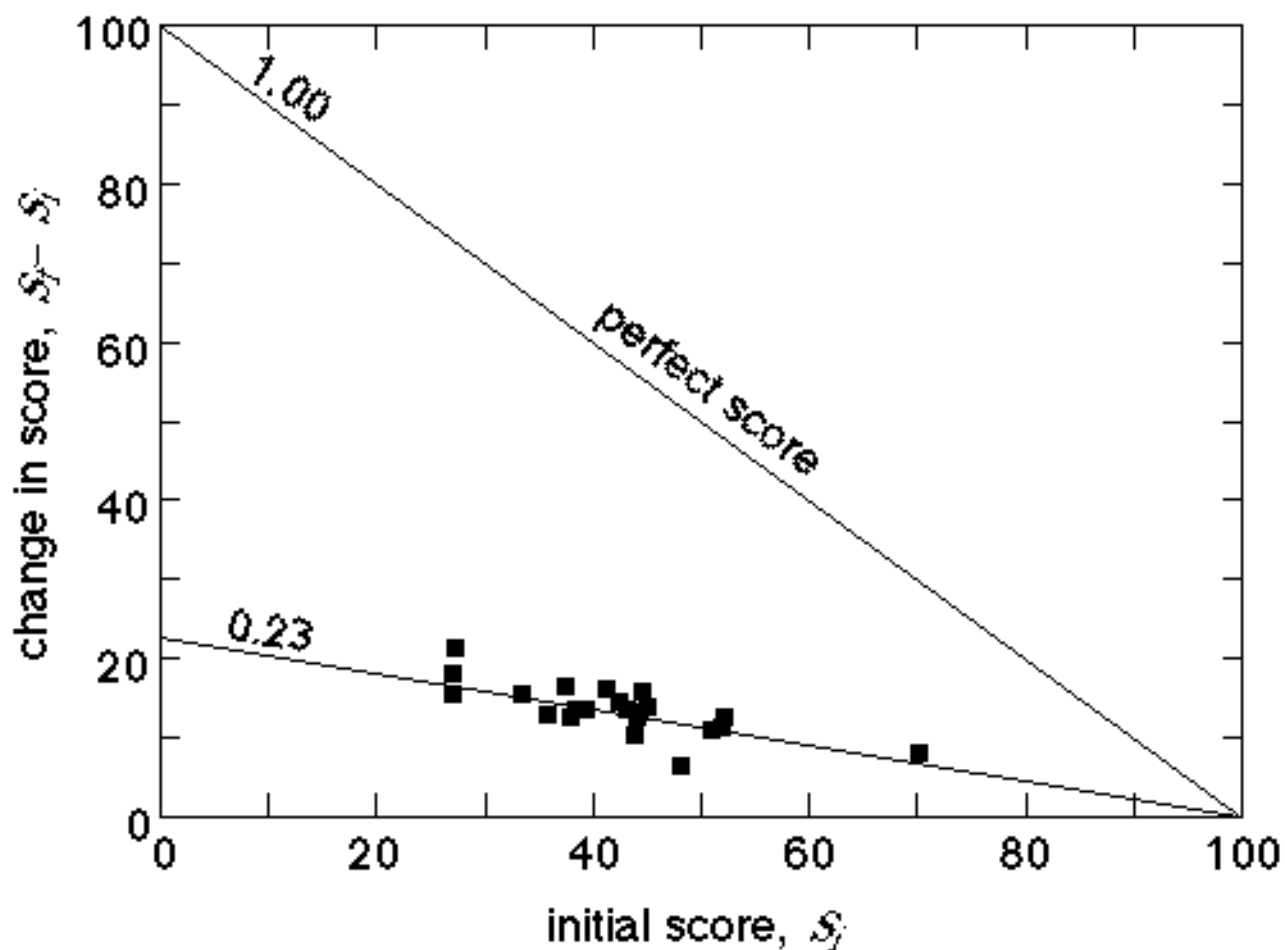

RESULTS

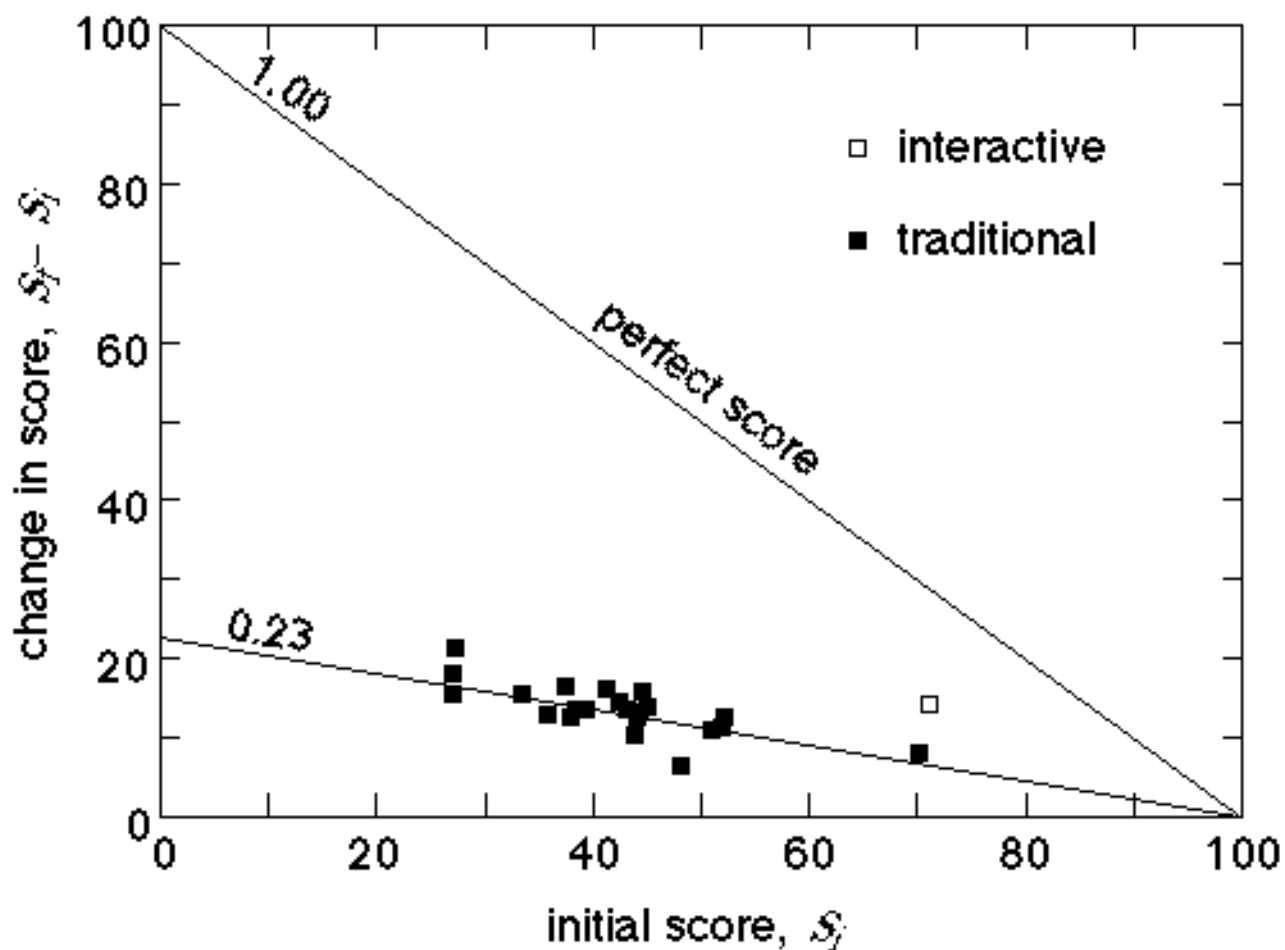

RESULTS

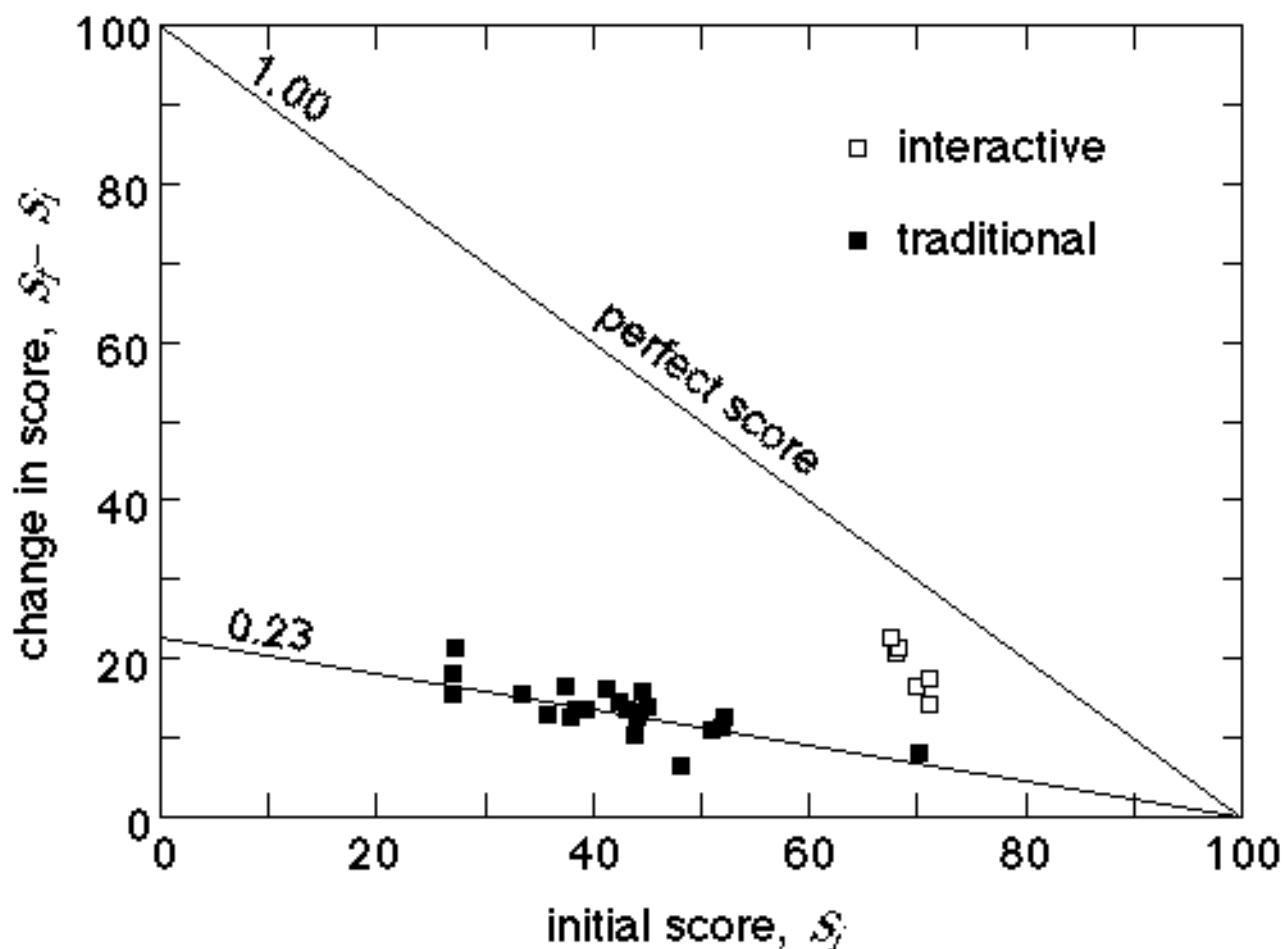

RESULTS

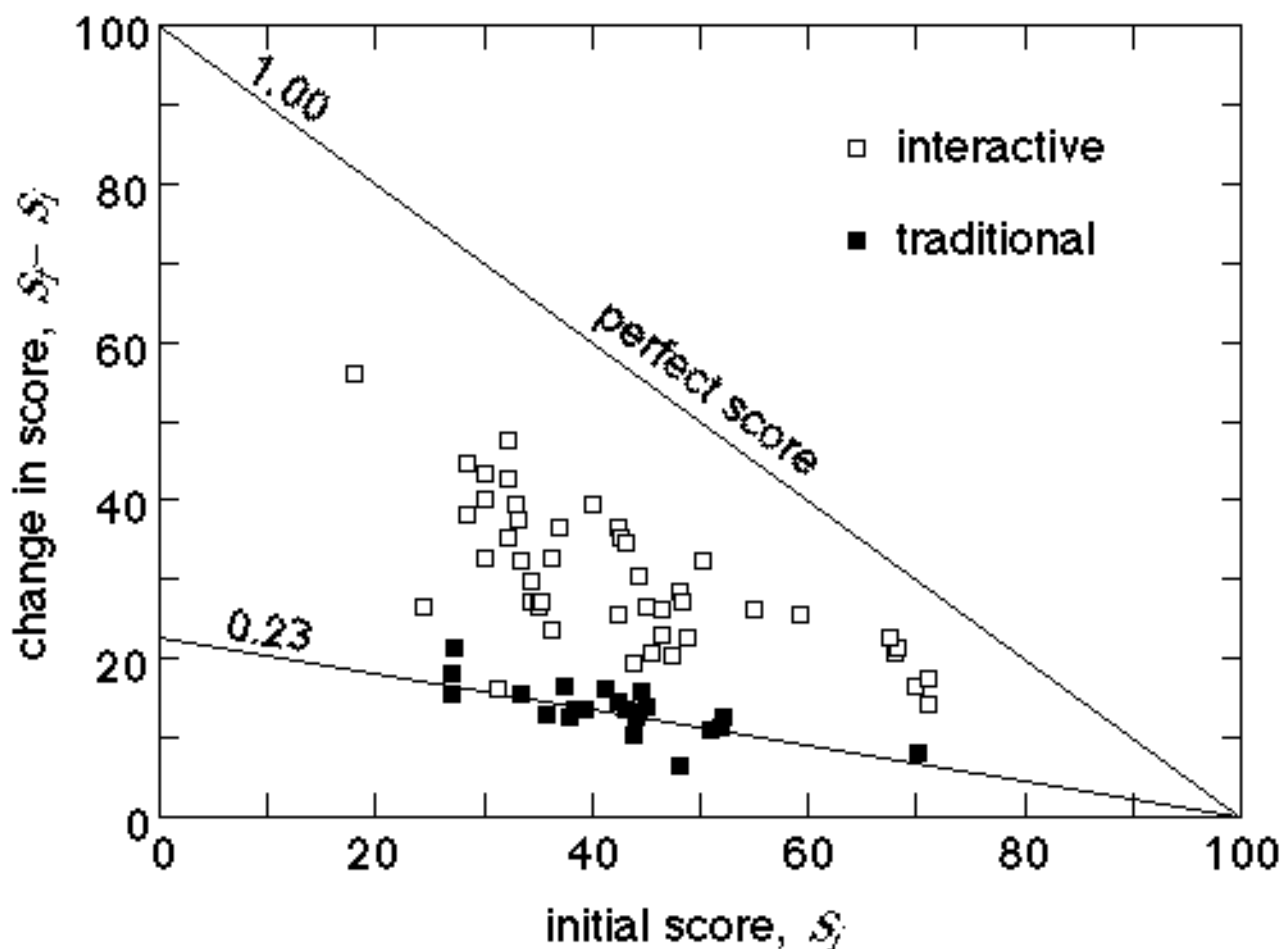

RESULTS

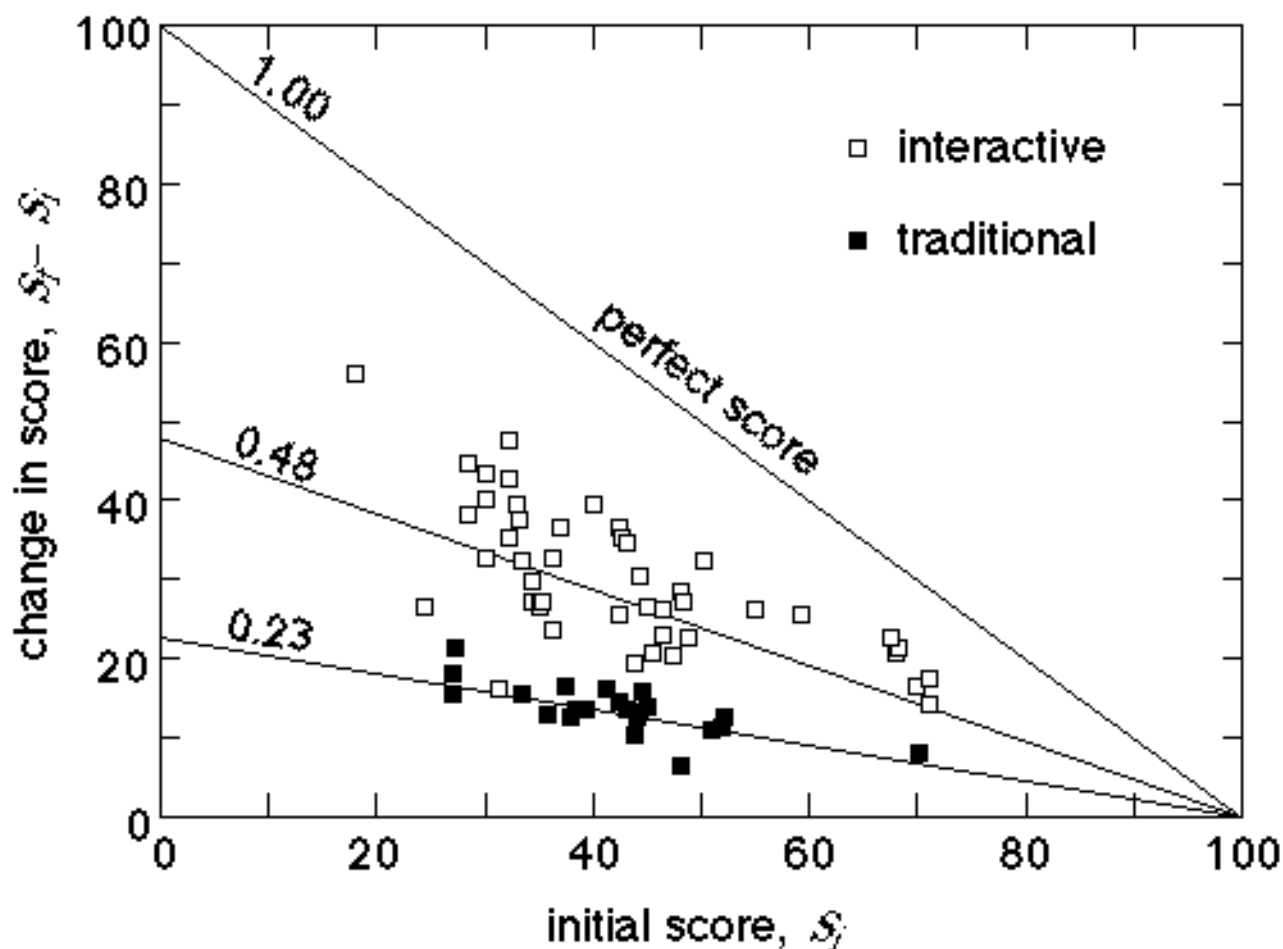

RESULTS

What about problem solving...?



RESULTS

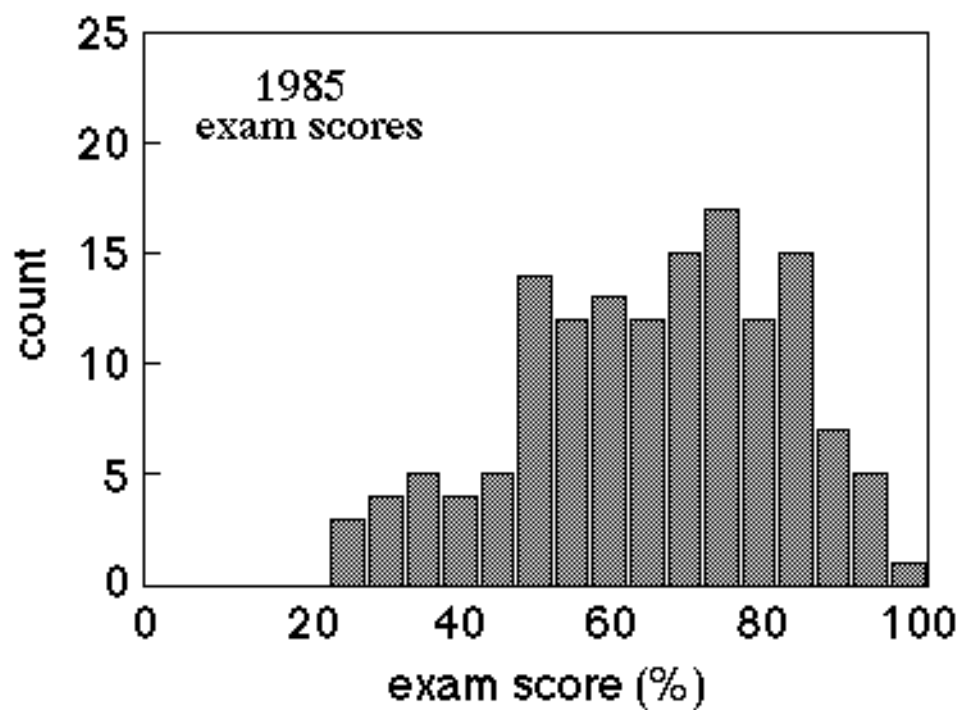

RESULTS

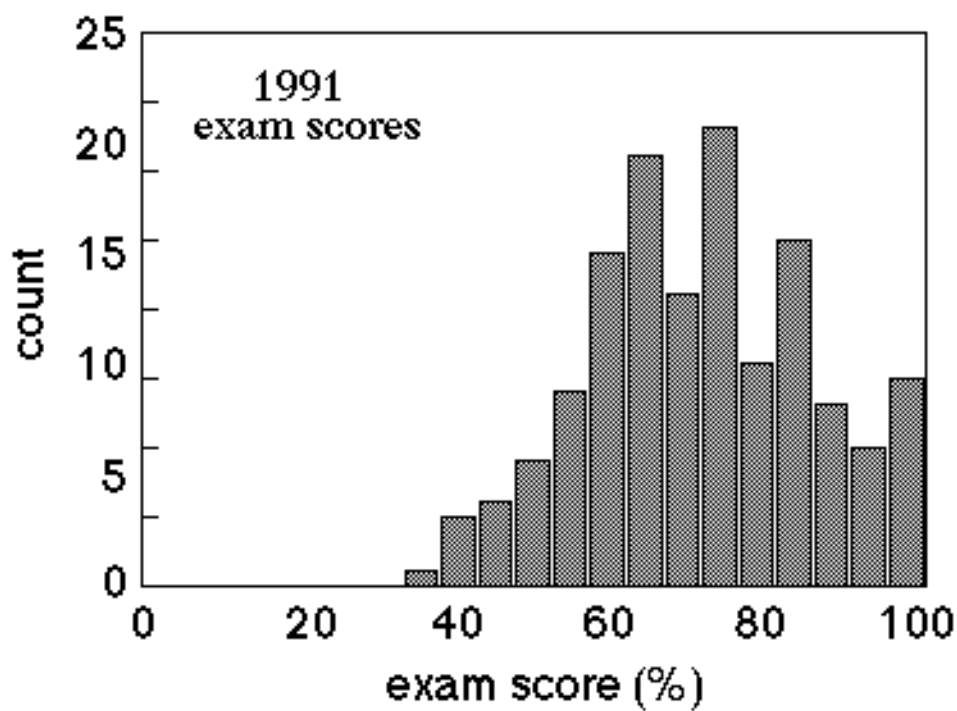

RESULTS

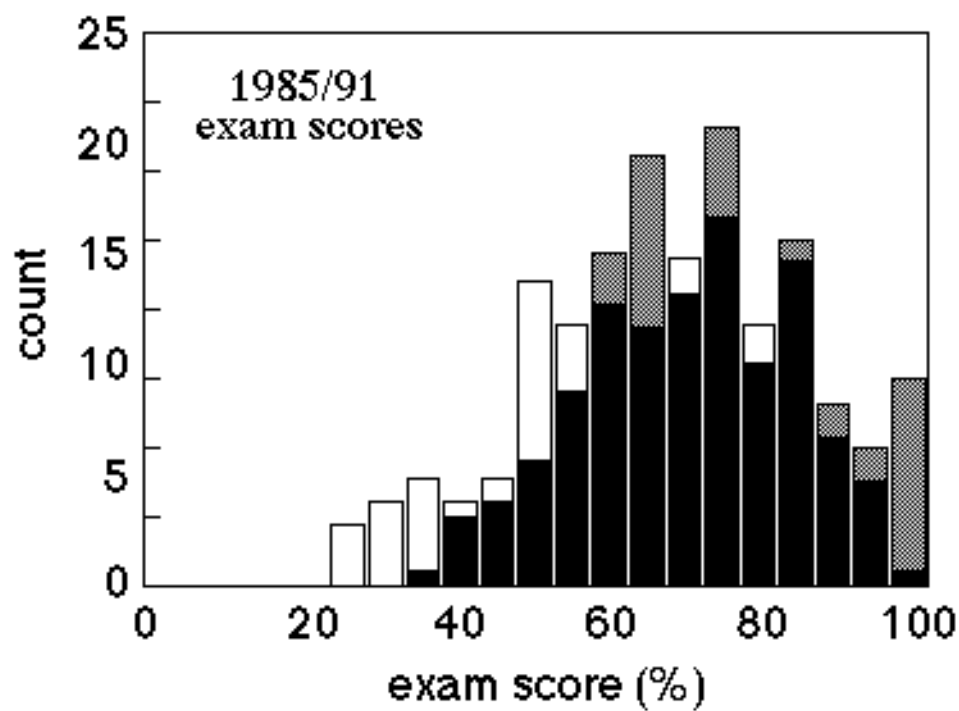

RESULTS

So, better understanding leads to better problem solving ...



RESULTS

So, better understanding leads to better problem solving ...

(but “good” problem solving doesn’t always indicate understanding!)



STUDENT REACTIONS



WHO BENEFITS?

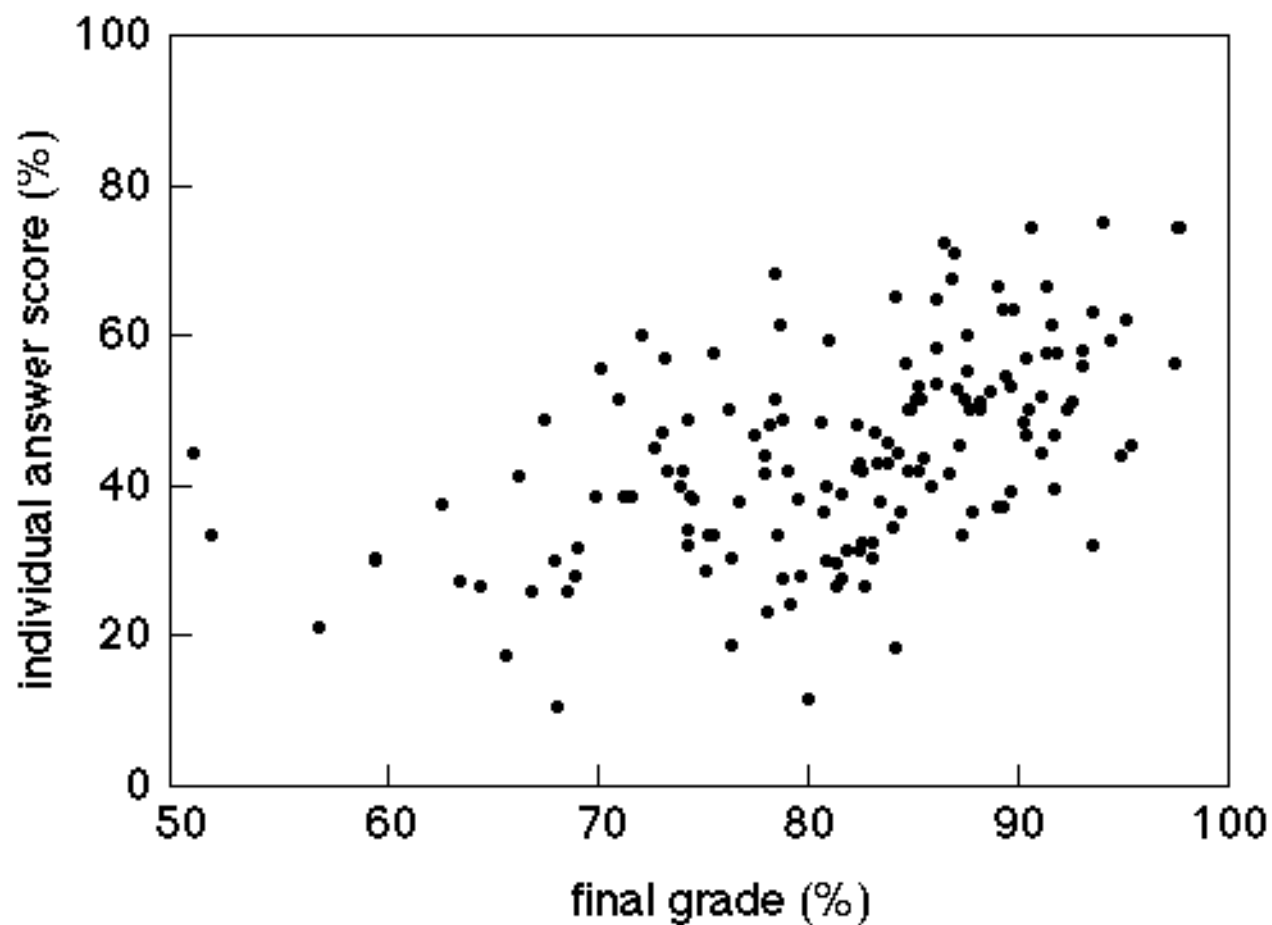

WHO BENEFITS?

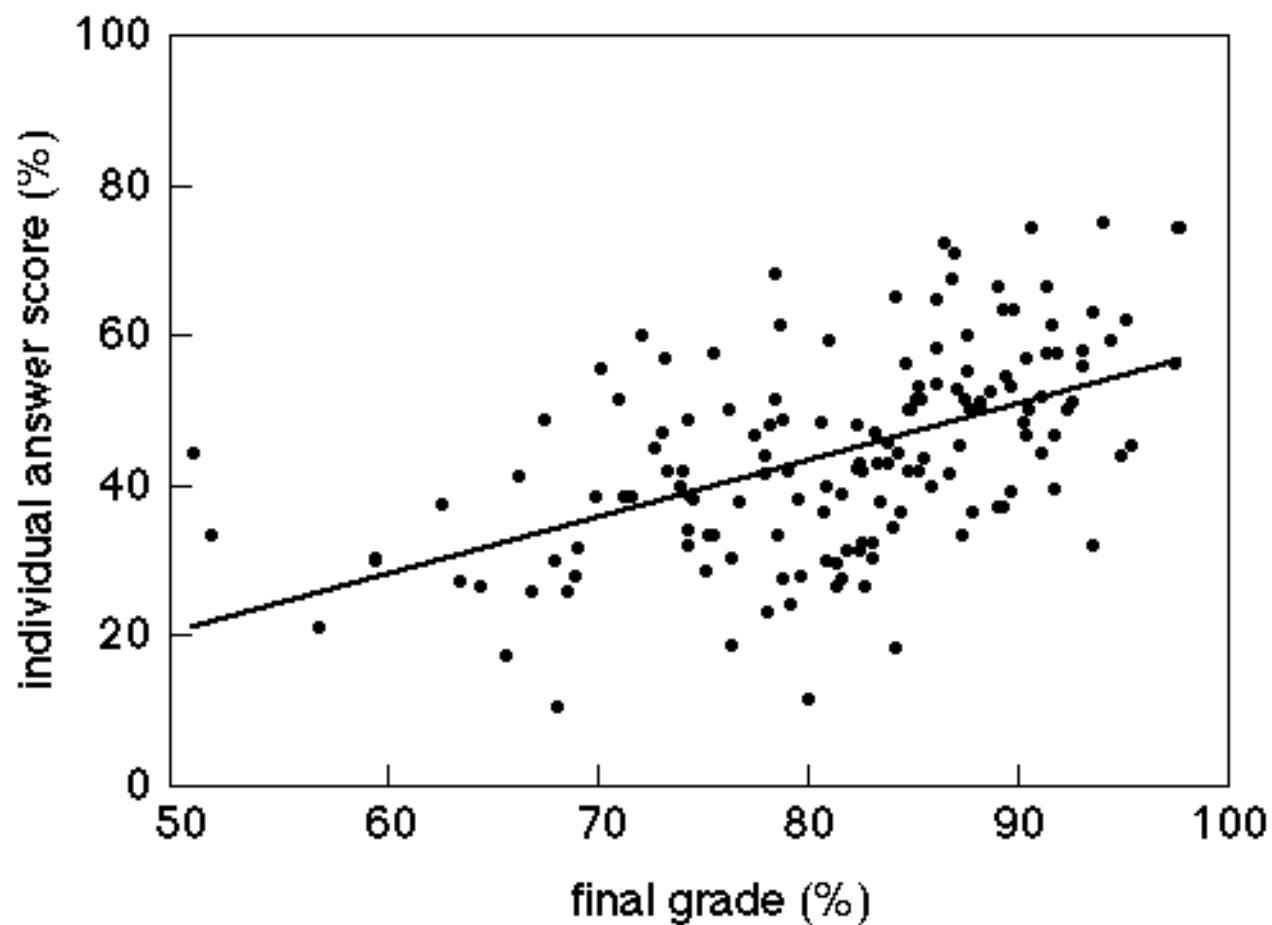

WHO BENEFITS?

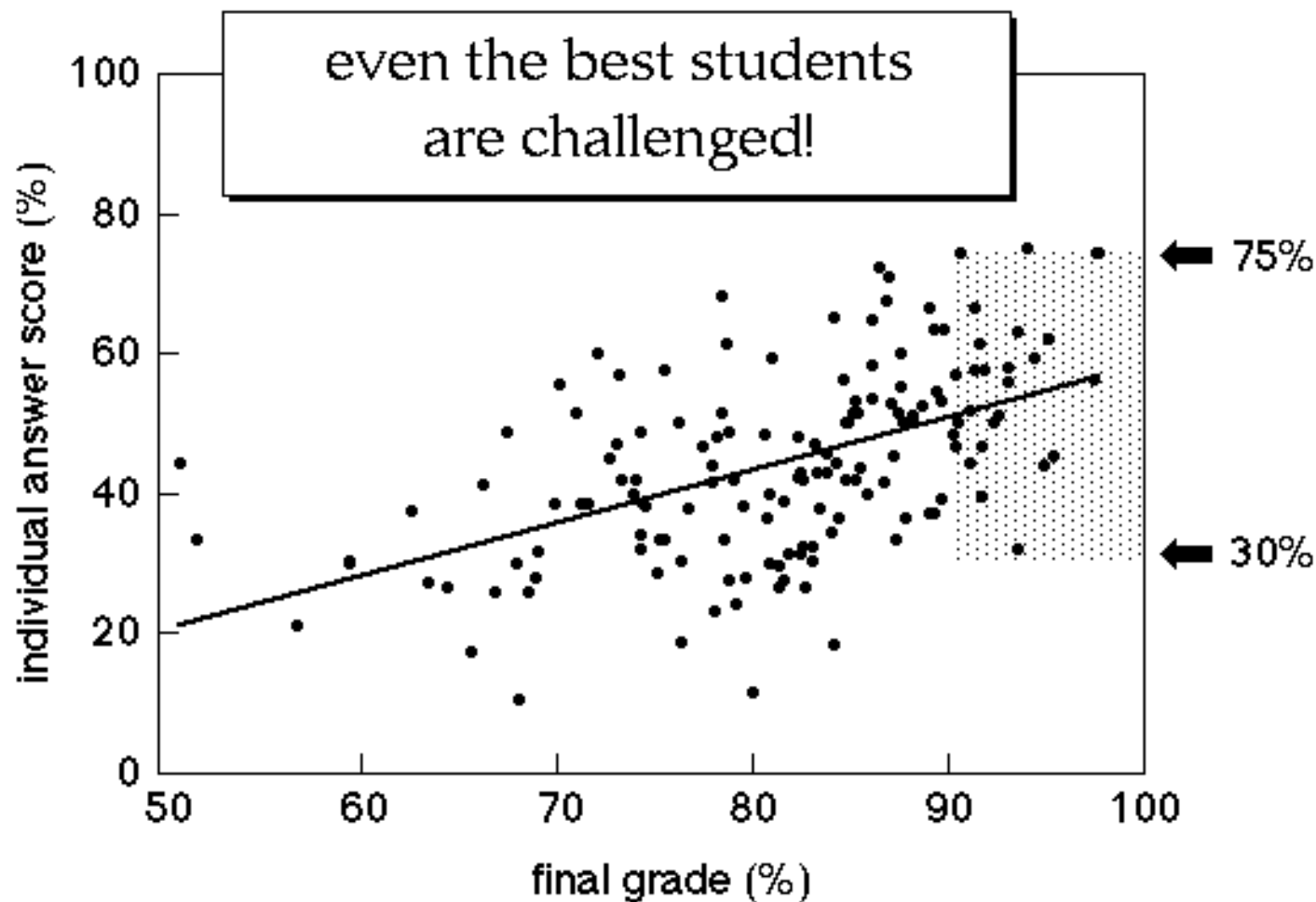

WHO BENEFITS?

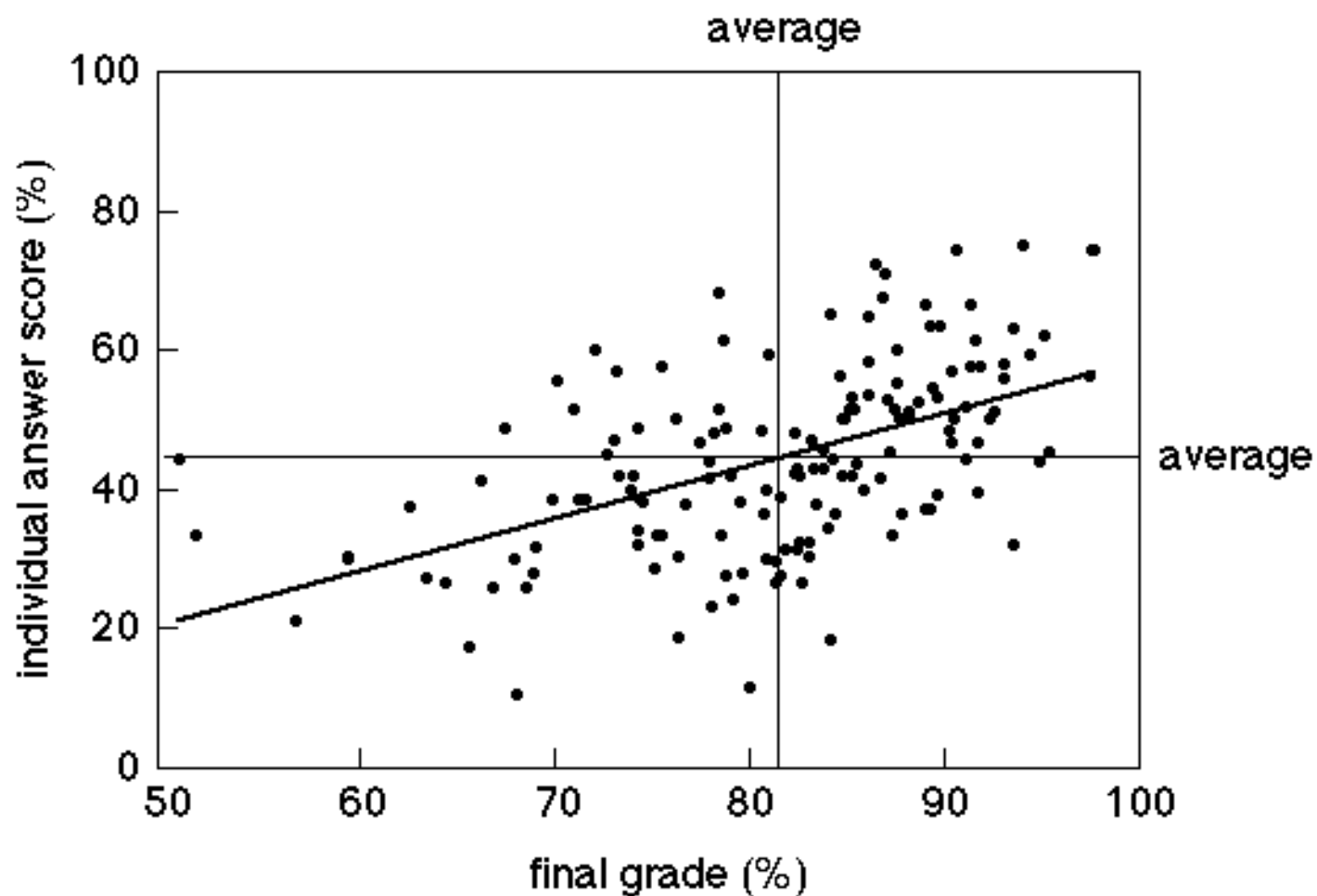

WHO BENEFITS?

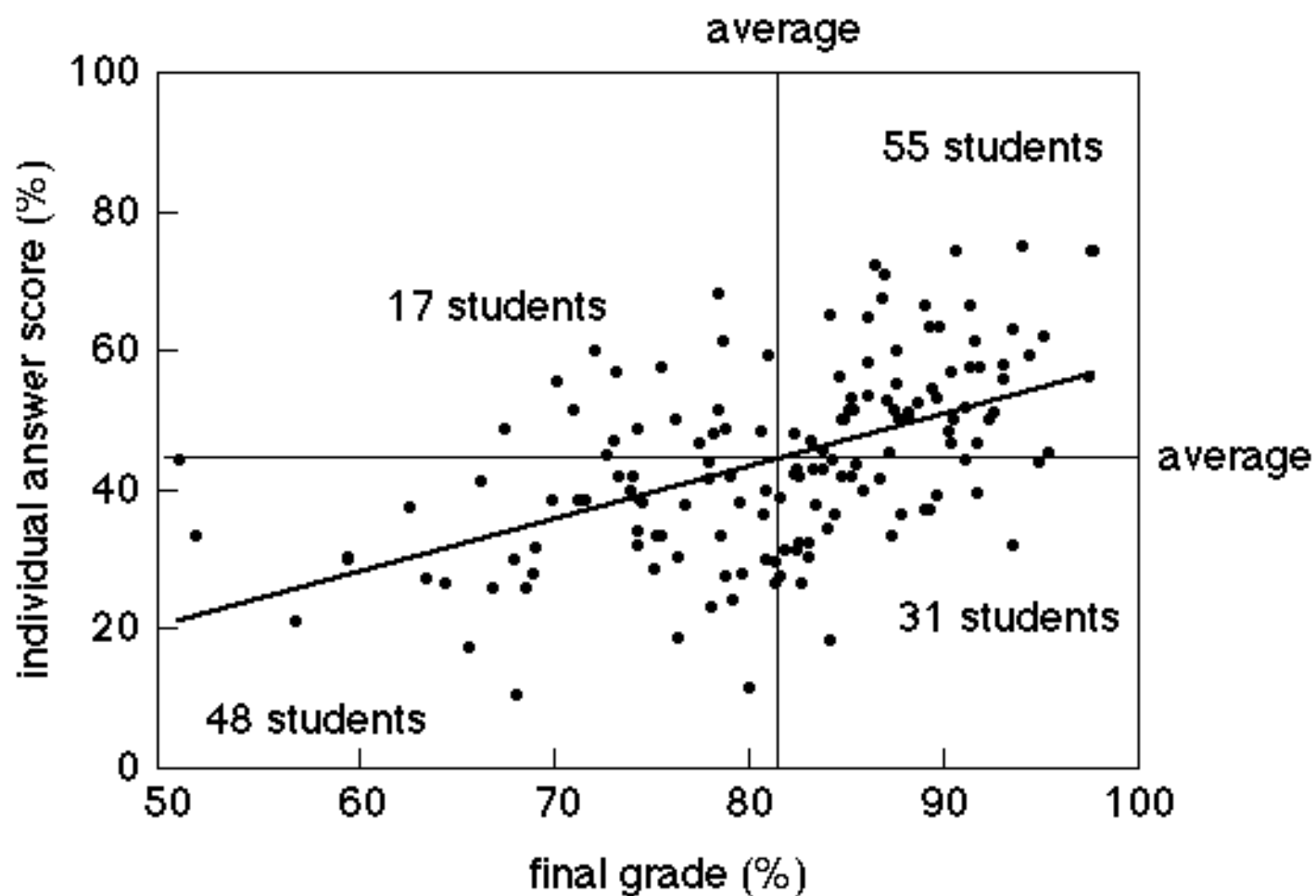

Why does it work?

Students:

- gets them thinking
- helps uncover misunderstandings
- boosts confidence

Faculty:

- change of format, not content
- with existing questions, little effort
- adaptable



Acknowledgments

Catherine Crouch (Harvard)
Deborah Alpert (Harvard)
Michael Aziz (Harvard)
William Paul (Harvard)
Tim Bozik (Prentice Hall)
David Hestenes (ASU)

Additional information:
<http://galileo.harvard.edu>

©1998 Eric Mazur



ESSENTIAL ELEMENTS

- ① Reading (before class)
- ② Participation (during class)
- ③ Problem-solving (after class)
- ④ Appropriate testing/assessment



READING

Incentive: Web-based assignment due night before class

- two free-response questions on content
- “What did you find difficult or confusing about the reading?”

Instructor benefit:

- learns what students find difficult
- turn student difficulties into ConcepTests



READING

Quality of reading and assignment matters!

Class	FCI pre	reading	assignment	correct
11a (F96)	0.68	standard	summaries	83%
11a (F97)	0.68			
1a (F98)	0.49			



READING

Quality of reading and assignment matters!

Class	FCI pre	reading	assignment	correct
11a (F96)	0.68	standard	summaries	83%
11a (F97)	0.68	new	summaries	89%
1a (F98)	0.49			



READING

Quality of reading and assignment matters!

Class	FCI pre	reading	assignment	correct
11a (F96)	0.68	standard	summaries	83%
11a (F97)	0.68	new	summaries	89%
1a (F98)	0.49	new	responses	82%



READING

Reading:

- is a valuable skill
- provides multiple exposure
- is self-paced

Textbooks can be edited (but lectures can't)



PROMOTING PARTICIPATION

- Motivate students
- Choose appropriate questions
- Poll students for answers
- Reward participation



CHOOSING GOOD QUESTIONS

- Focus on a key concept
- Engage student interest
 - demonstrations
 - real-life situations
 - magic/intrigue
- Identify student difficulties (research)
 - use optimum (35–65%) range
 - use typical student responses



RESOURCES

Peer Instruction: A User's Manual
Eric Mazur (Prentice Hall, 1997)

<http://galileo.harvard.edu>



POLLING METHODS

Methods:

- show of hands
- flashcards
- classroom network

Trade-offs:

- anonymity
- cost
- complexity and reliability



REWARDING STUDENTS

- Reward participation

credit for reading contingent on participation

conceptual and quantitative questions on exams

- Don't penalize collaboration

noncompetitive grading

promote group work on homework



PROBLEM SOLVING

- Home work
 - mostly quantitative problems
 - 20% of final grade
- Workshops (discussion sections)
 - tutorial worksheets
 - instructor demonstrates one problem
 - group work on difficult homework problems



THE PROBLEM WITH PROBLEMS

On a Saturday afternoon, you pull into a parking lot with unmetered spaces near a shopping area. You circle around, but there are no empty spots. You decide to wait at one end of the lot, where you can see (and command) about 20 spaces.



THE PROBLEM WITH PROBLEMS

On a Saturday afternoon, you pull into a parking lot with unmetered spaces near a shopping area. You circle around, but there are no empty spots. You decide to wait at one end of the lot, where you can see (and command) about 20 spaces. On average people shop for about 2 hours.



THE PROBLEM WITH PROBLEMS

On a Saturday afternoon, you pull into a parking lot with unmetered spaces near a shopping area. You circle around, but there are no empty spots. You decide to wait at one end of the lot, where you can see (and command) about 20 spaces. On average people shop for about 2 hours.



THE PROBLEM WITH PROBLEMS

On a Saturday afternoon, you pull into a parking lot with unmetered spaces near a shopping area where people are known to shop, on average, for two hours. You circle around, but there are no empty spots. You decide to wait at one end of the lot, where you can see (and command) about 20 spaces.

How long do you have to wait before someone frees up a space?



TRADITIONAL VS. PEER INSTRUCTION

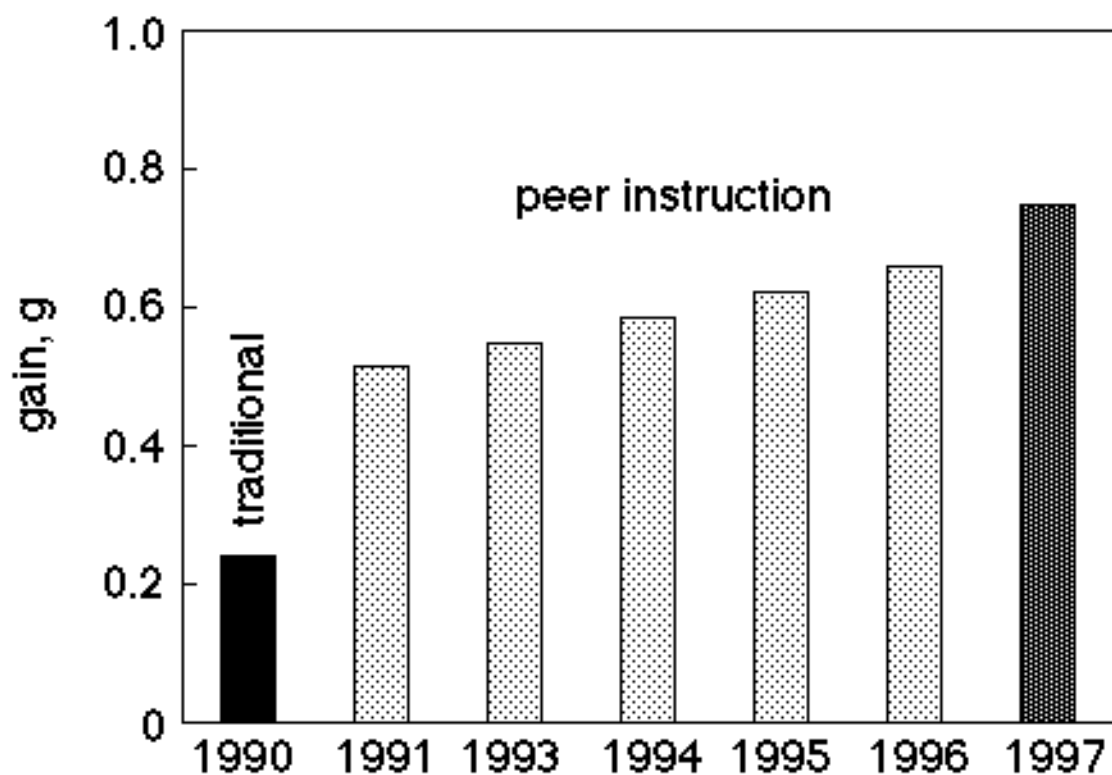

COVERAGE

Traditional lecture:

- “covers” a lot
- students retain little

Peer Instruction:

- less material treated in class
(reading & lecture *can* still cover the same)
- students learn more



EFFECTIVE TIME MANAGEMENT

Time allotment:

- “lecturing” 1/3 – 1/2
- ConcepTests (incl. explanations) 1/2 – 2/3

ConcepTest:

10–15 minutes

- Read question 1 minute
- Individual thinking 1 minute
- Discussion (listen, don't talk!) 2–3 minutes
- Explanation as necessary