

Outline

▶ **Problem**

Outline

▶ **Problem**

▶ **Cause**

Outline

▶ **Problem**

▶ **Cause**

▶ **Remedy**

We have a problem

**380,000 students take
introductory physics
each year...**

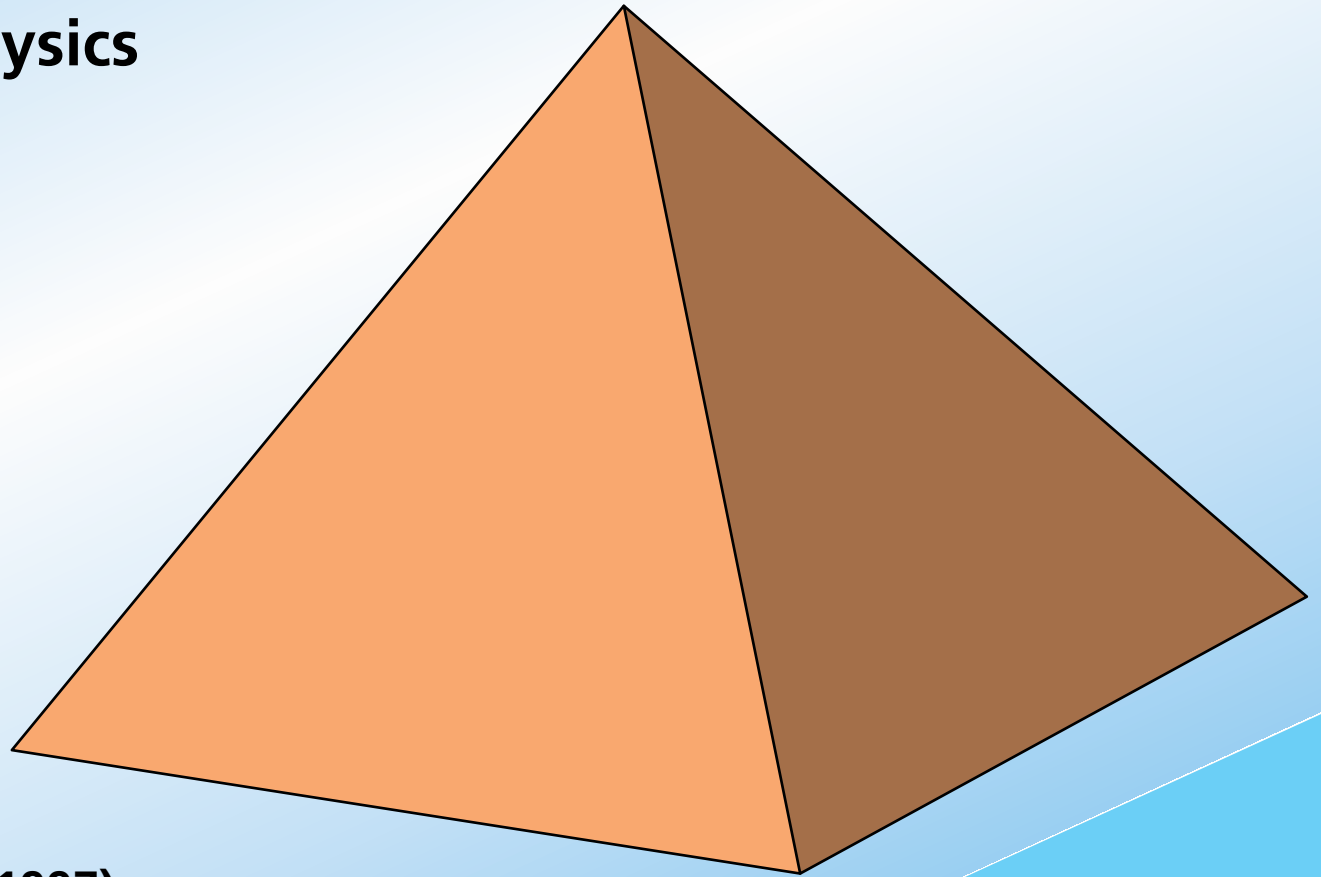

We have a problem

**about 1% of these get
a bachelor's degree
in physics**

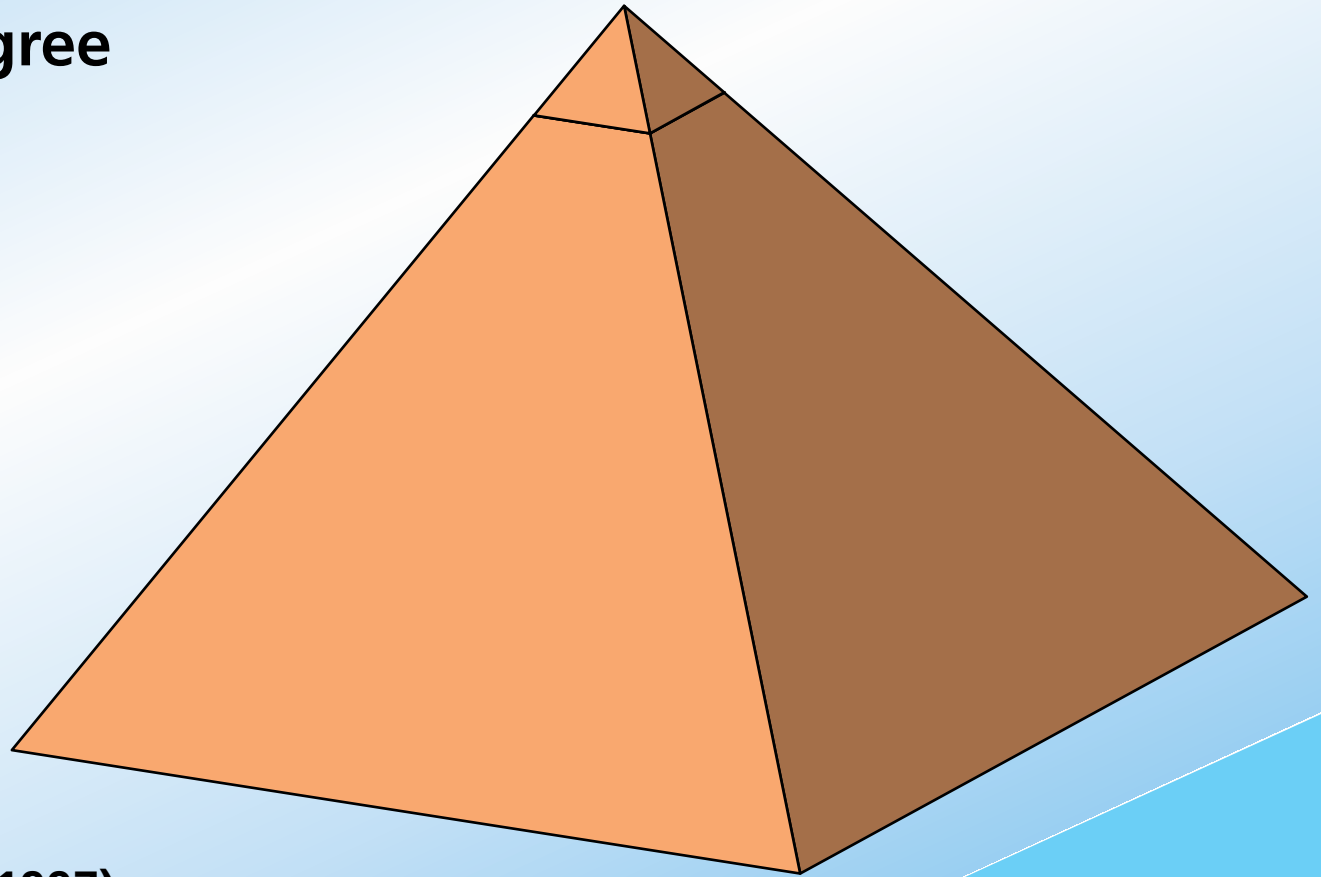

We have a problem

**Of the 4,300 students with
a bachelor's degree
in physics...**

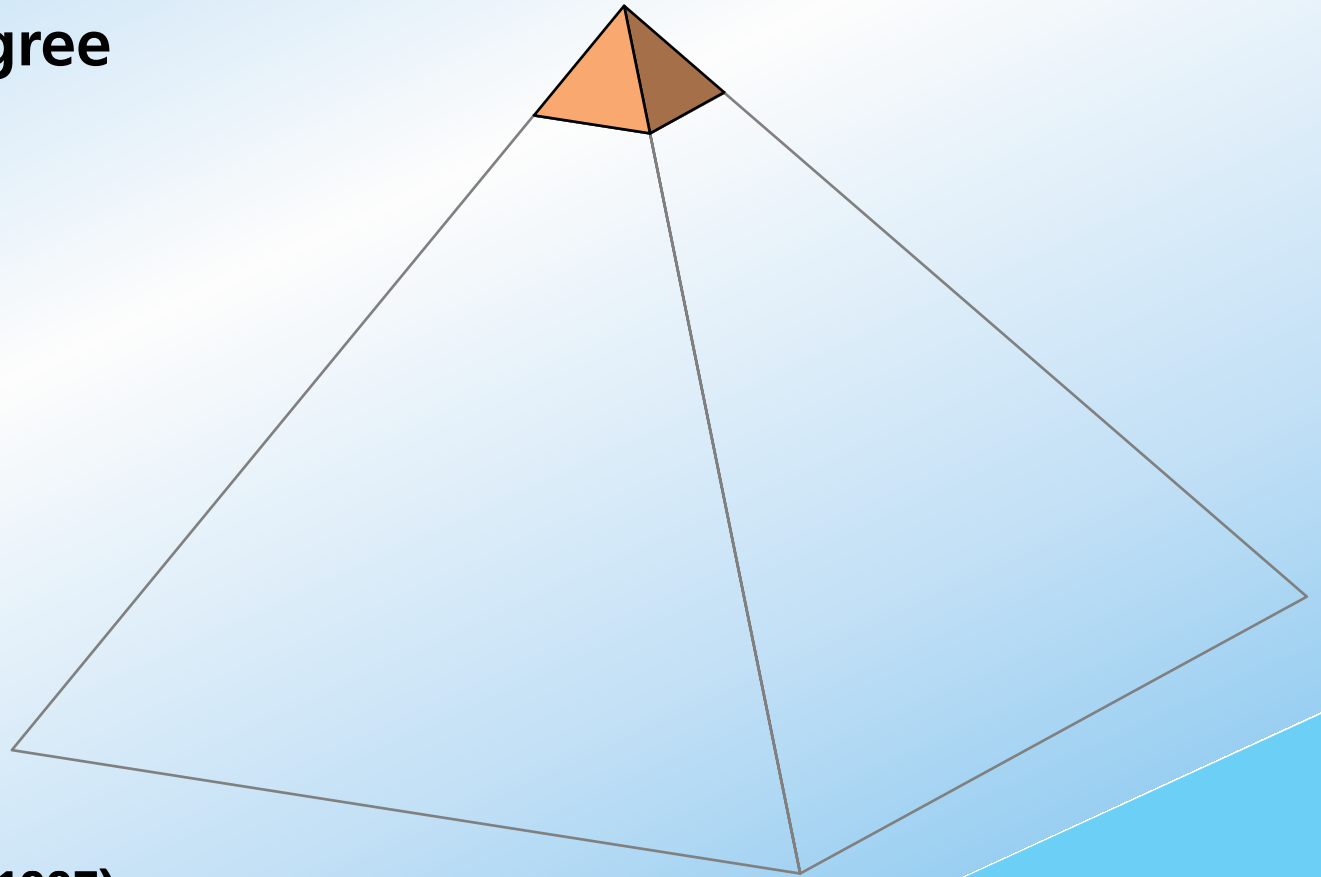

We have a problem

**about 35% go on to get a
Ph.D. in physics...**

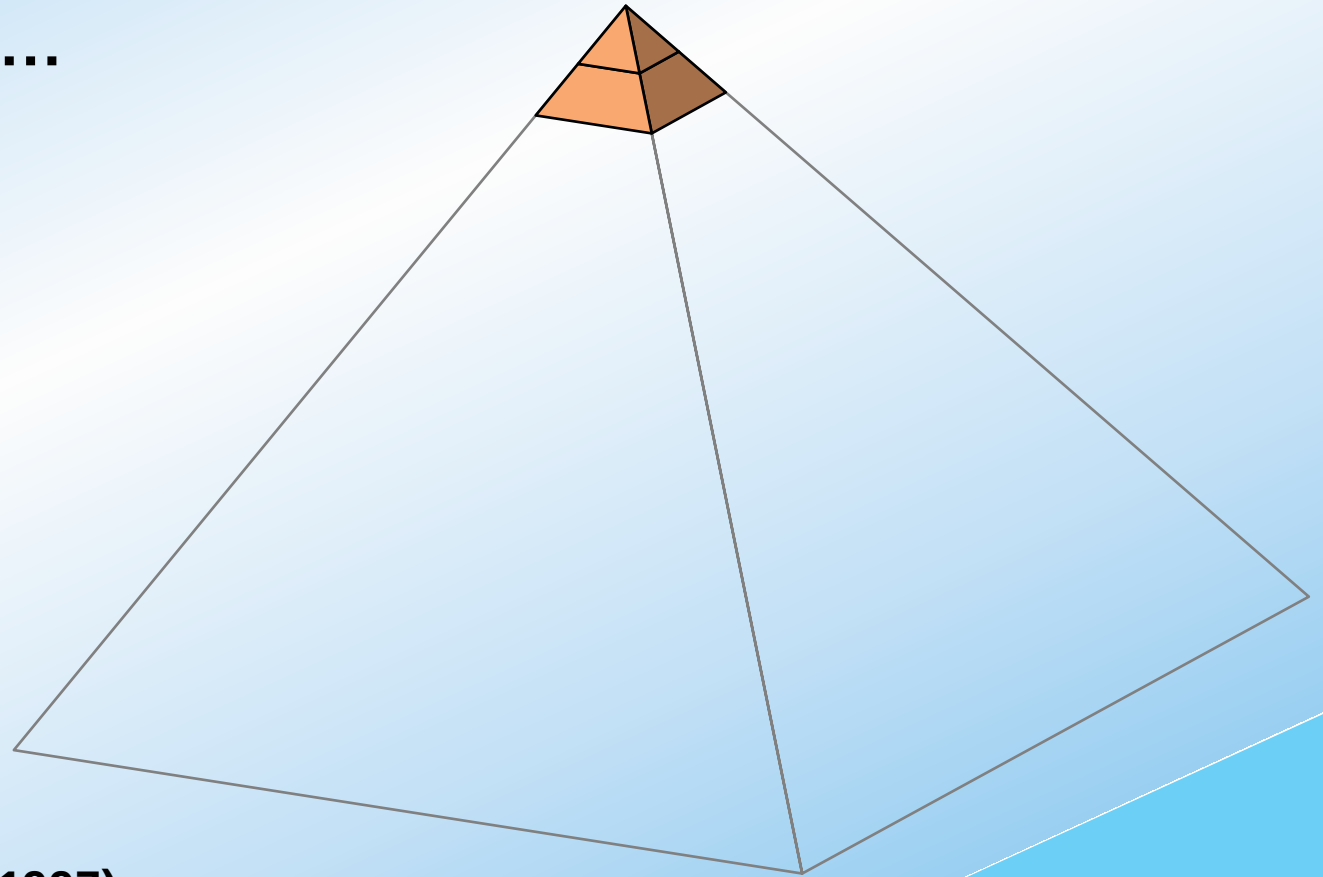

AIP Report R-151.33 (1997)

We have a problem

**That's one out of every
260 students in our
introductory
courses!**

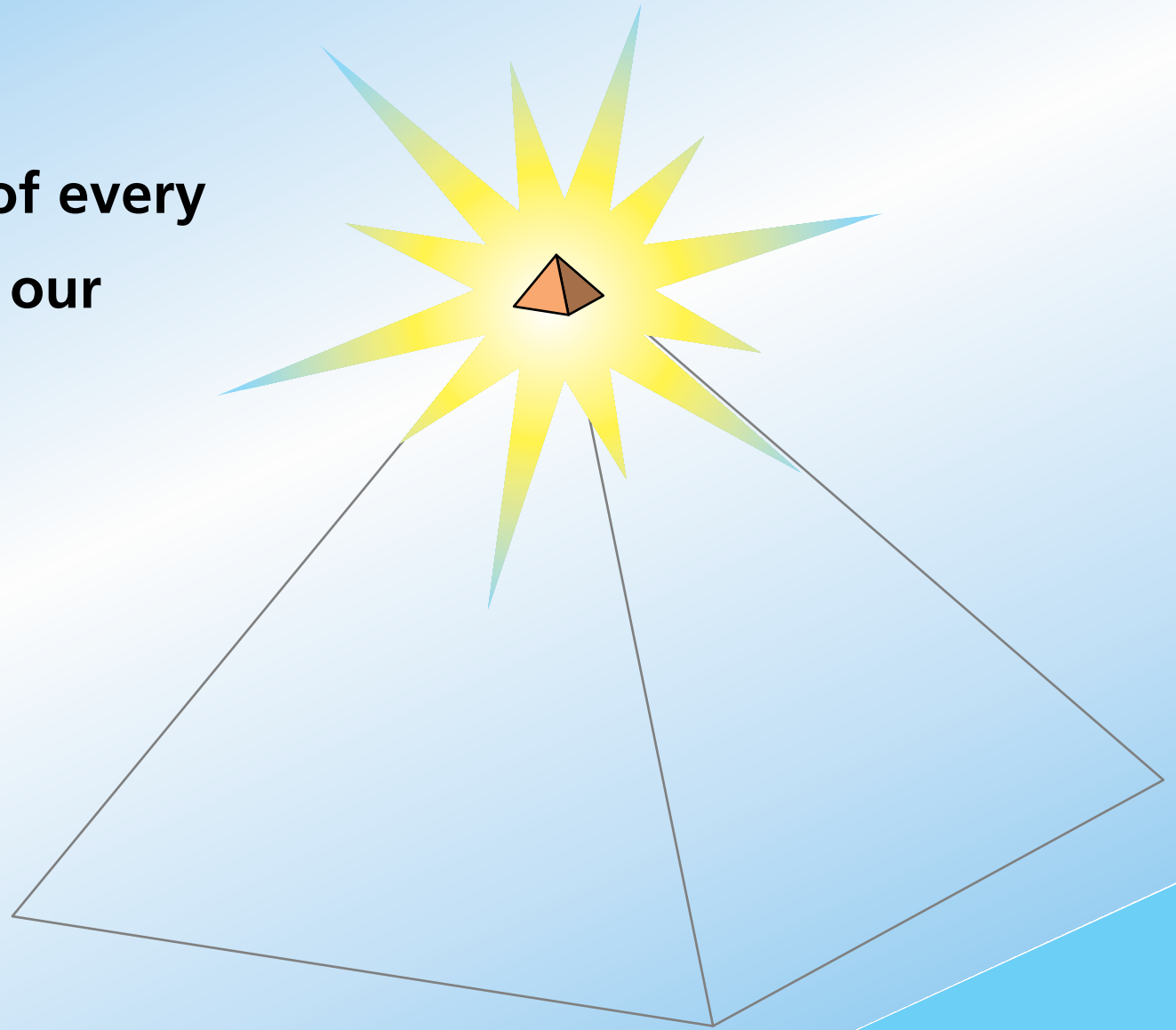

We have a problem

**What about the
other 259...?**

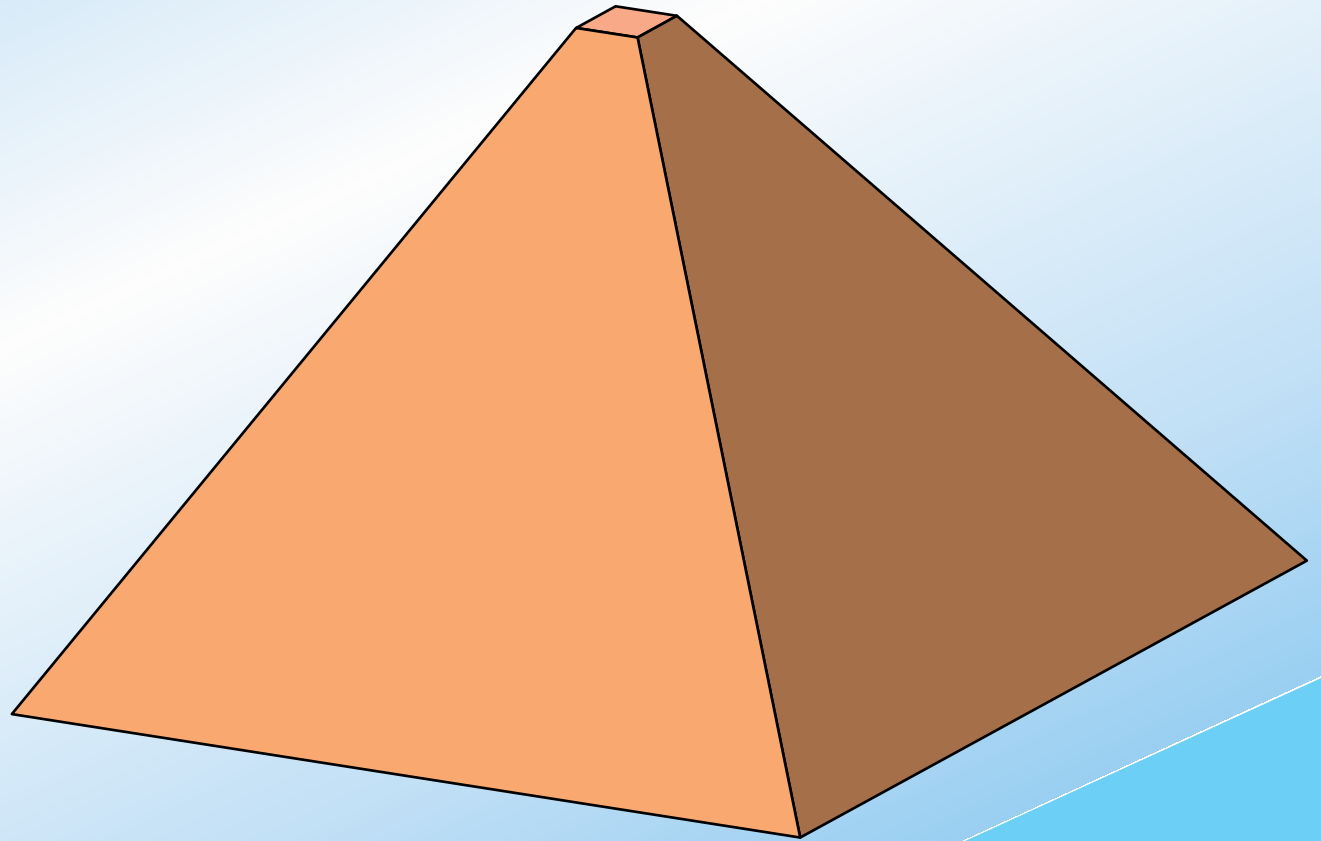

We have a problem

**What do we know
about these
students?**

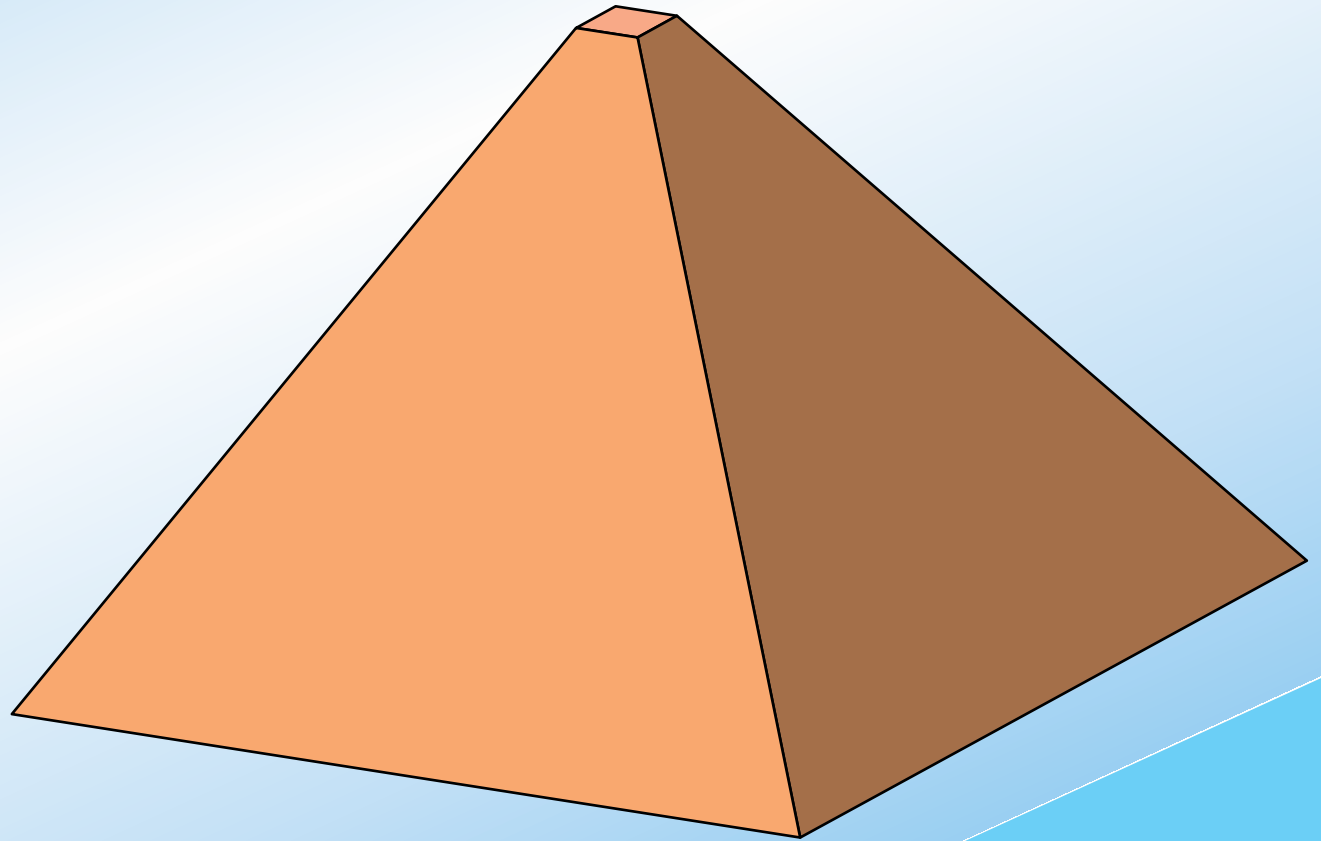

We have a problem

Some disturbing symptoms:

- ▶ **frustration**
- ▶ **lack of understanding**
- ▶ **lack of basic knowledge**

We have a problem

They know the jargon:

- ▶ **circular motion**
- ▶ **barometric pressure**
- ▶ **light radius**
- ▶ **something to the power times ten to the something**

We have a problem

They are aware of their lack of knowledge

- ▶ **I graduated from college but I didn't study *astronomy***
- ▶ **It's been a while since I've had physics**

We have a problem

They are aware of their lack of knowledge

- ▶ **I graduated from college but I didn't study *astronomy***
- ▶ **It's been a while since I've had physics**

...and they don't care!

We have a problem

Should we worry?

We have a problem

We'd better!

We have a problem

"I took four years of science and four years of math...

**A waste of my time,
a waste of the teacher's time,
and a waste of space...**

**You know,
I took *physics*.**

For *what?*"





Why do we have this problem?

Why do we have this problem?

Lectures focus on transfer of information...

Why do we have this problem?

Lectures focus on transfer of information...

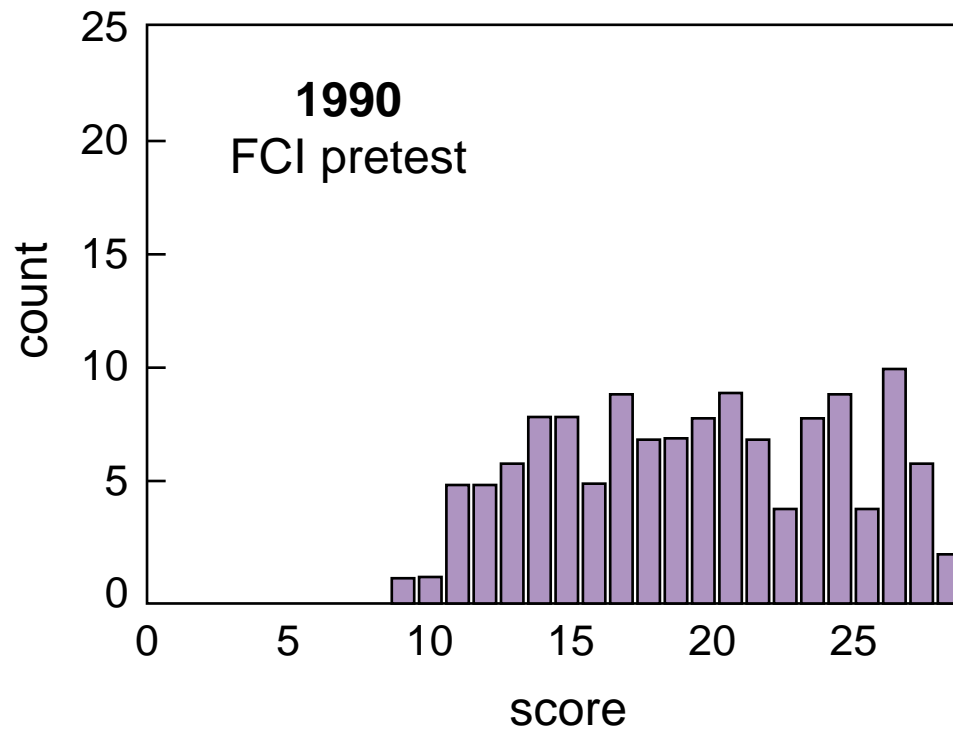

Why do we have this problem?

Lectures focus on transfer of information...

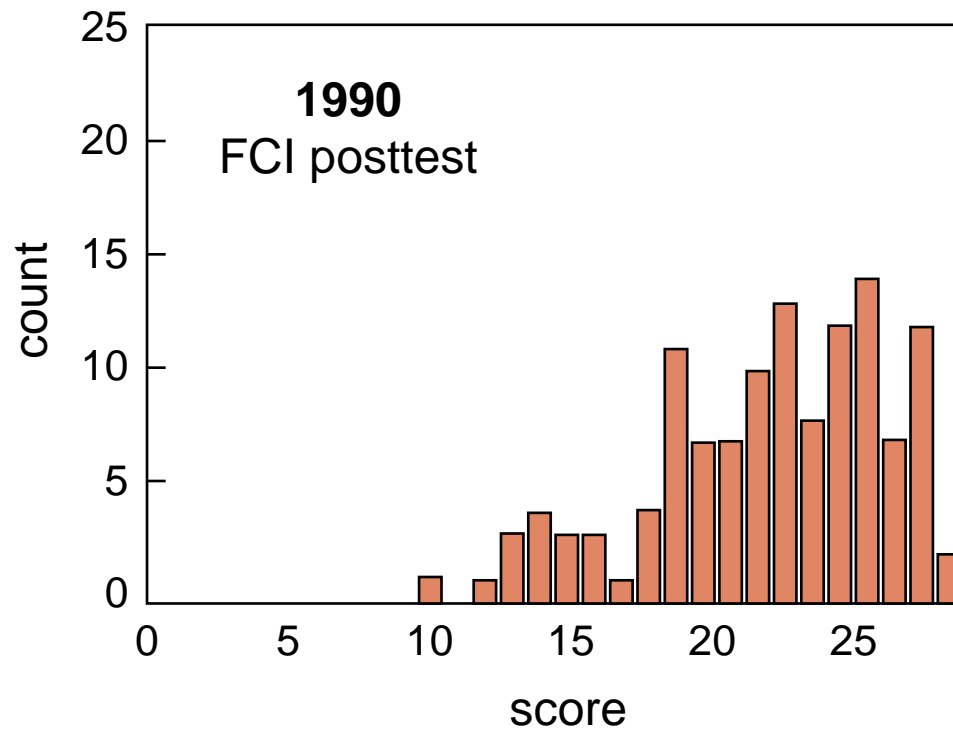

Why do we have this problem?

Lectures focus on transfer of information...

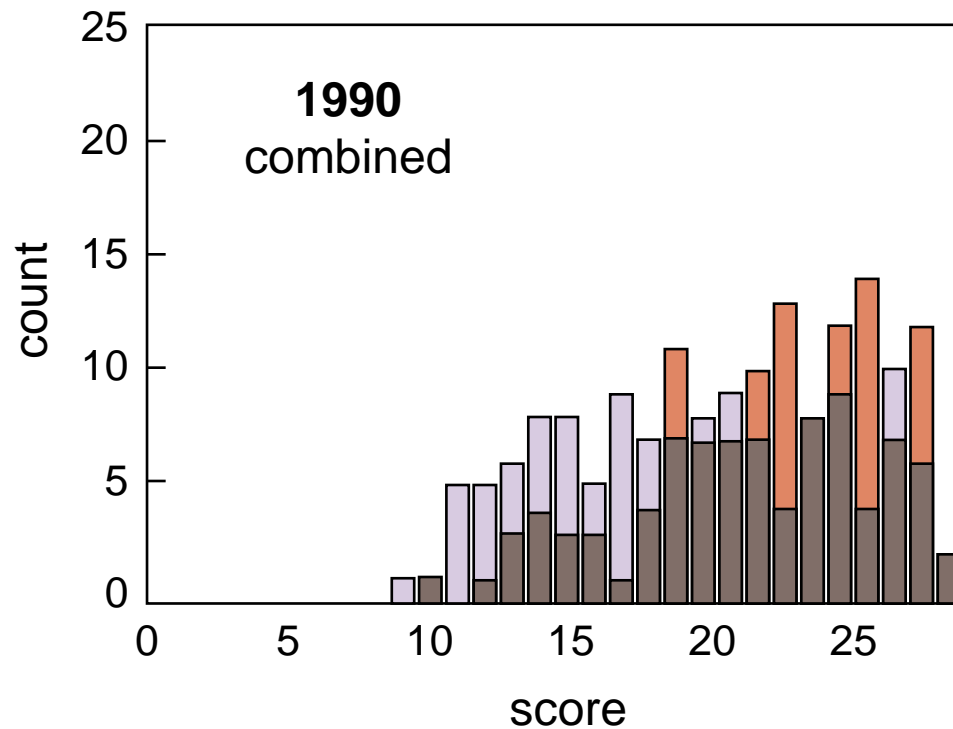

Why do we have this problem?

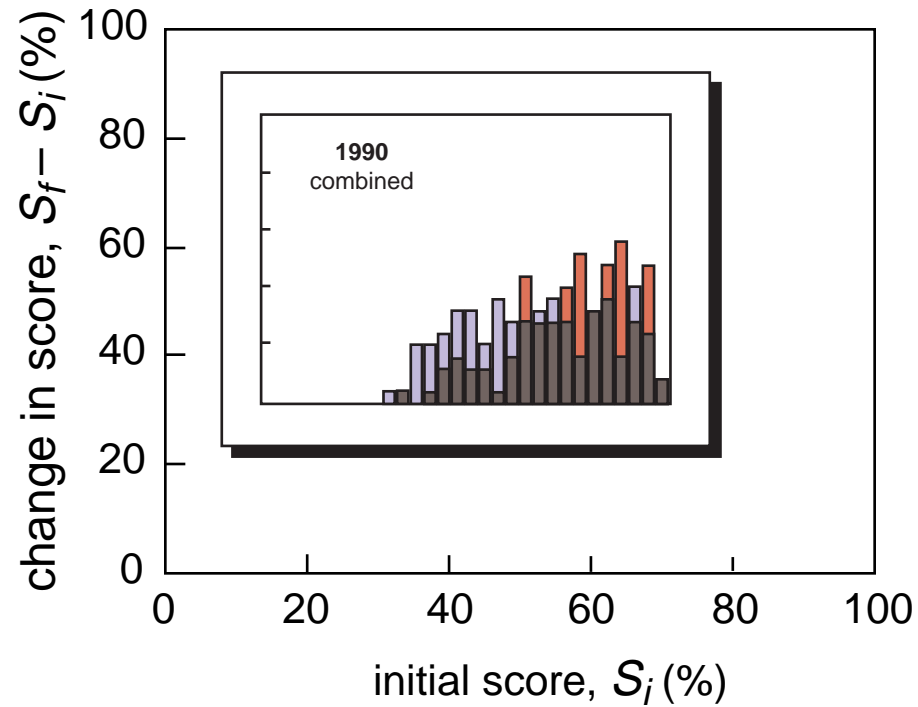

Why do we have this problem?

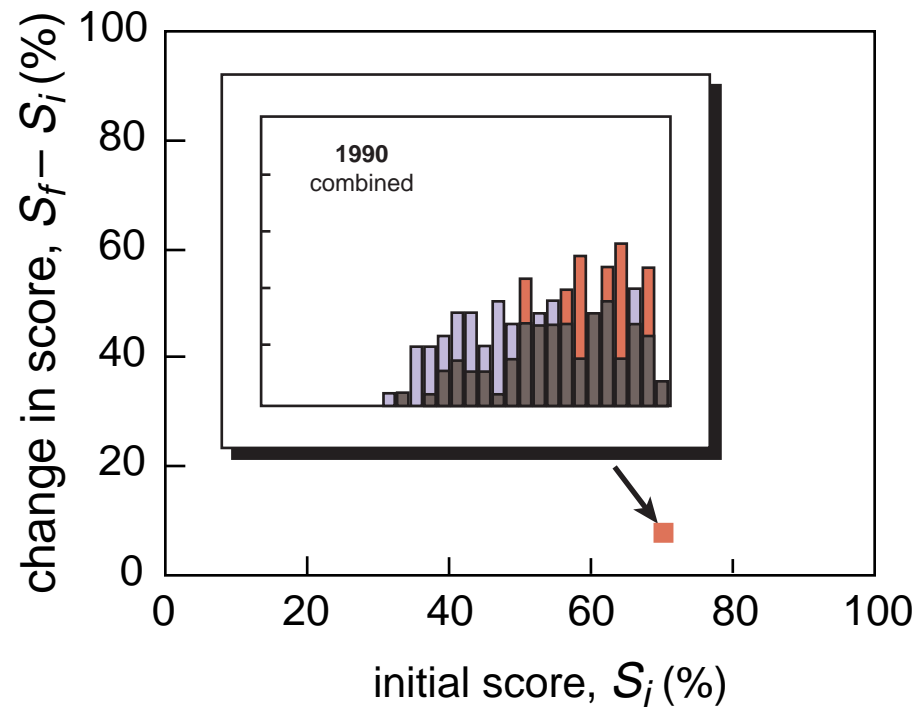

Why do we have this problem?

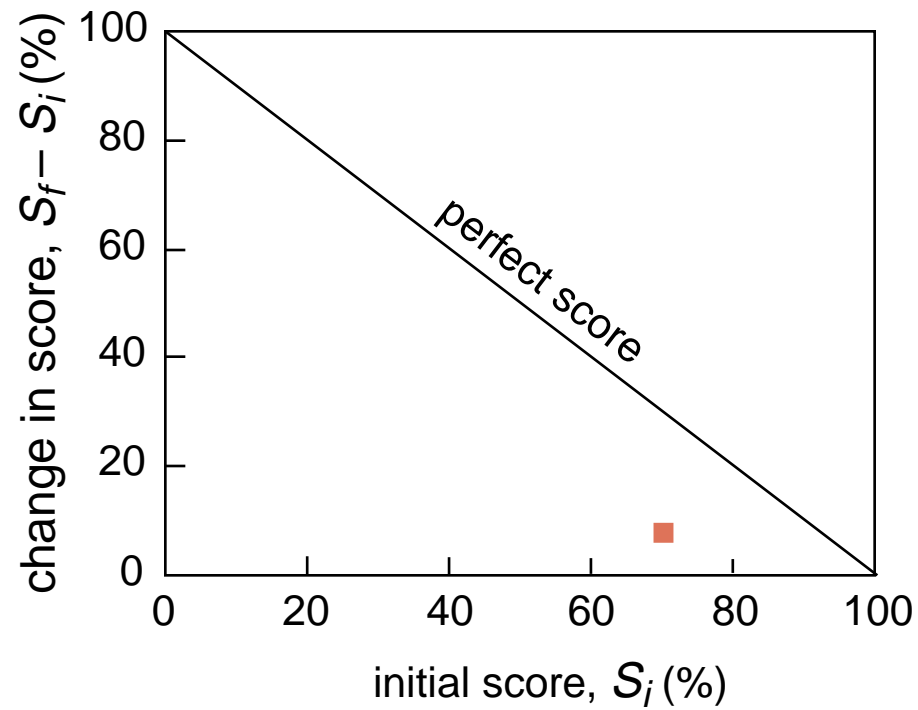

Why do we have this problem?

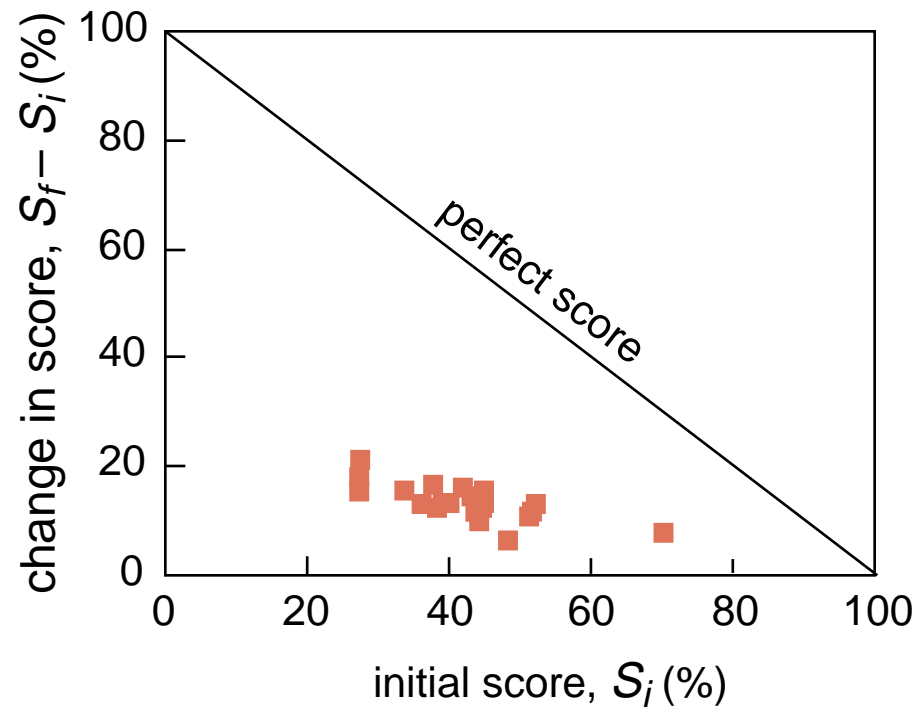

Why do we have this problem?

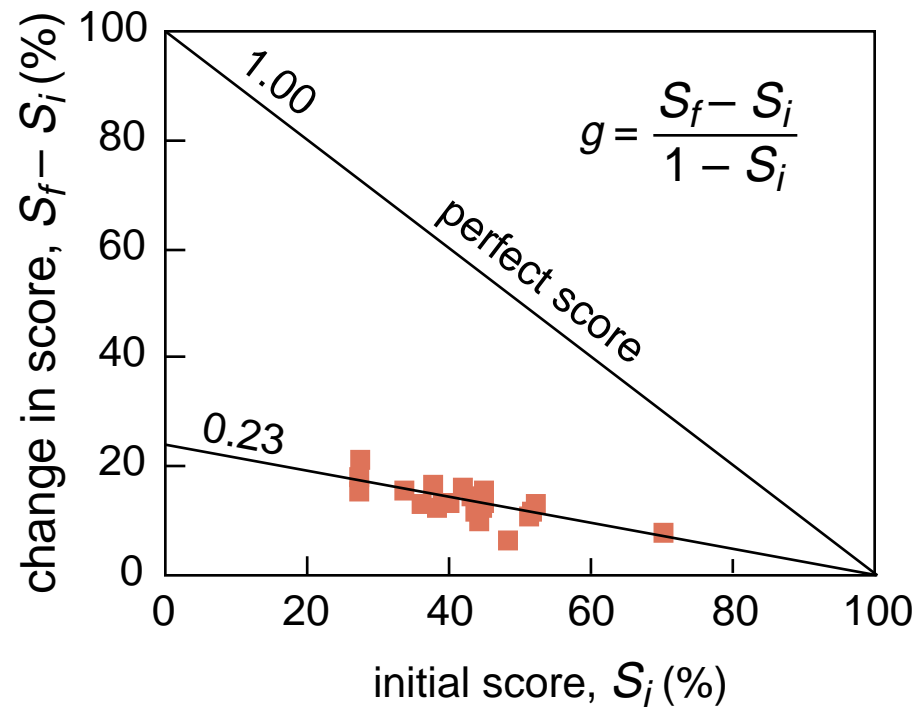

Why do we have this problem?

Conventional problems reinforce bad study habits

Why do we have this problem?

Conventional problems reinforce bad study habits

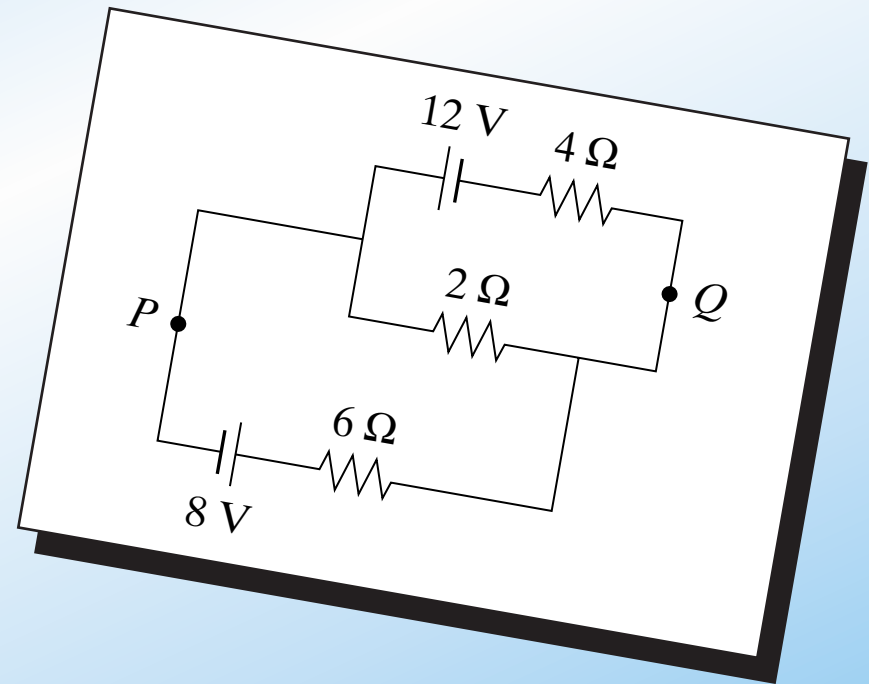

Why do we have this problem?

Conventional problems reinforce bad study habits

Calculate:

- (a) the current in the $2\text{-}\Omega$ resistor, and
- (b) the potential difference between points P and Q

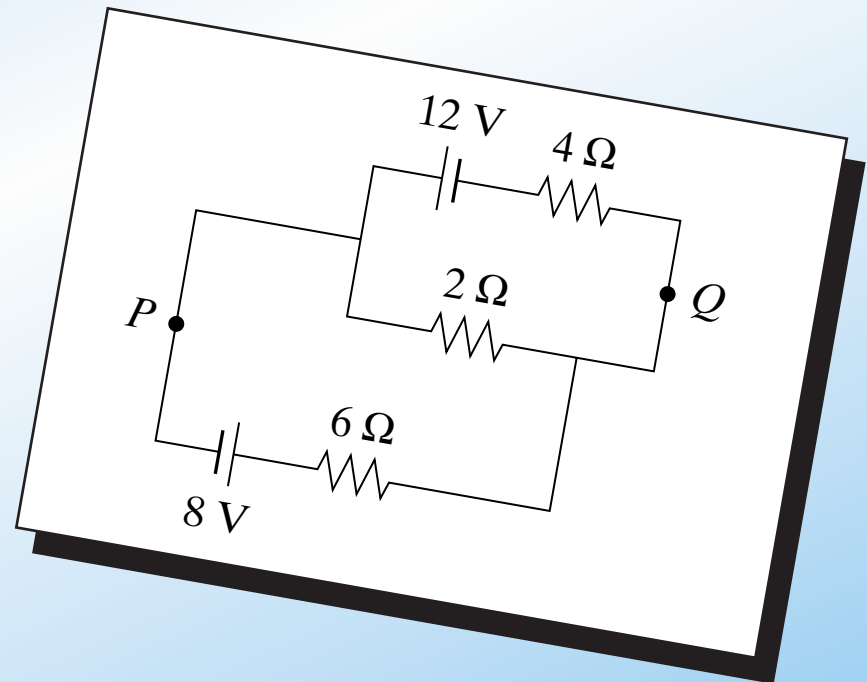

Why do we have this problem?

Are basic principles understood?

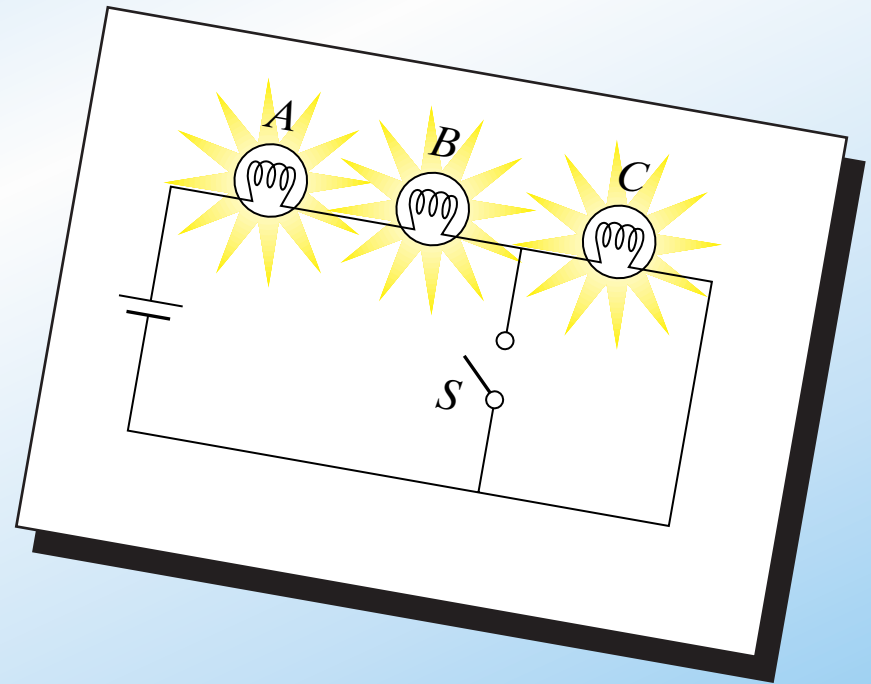

Why do we have this problem?

Are basic principles understood?

When S is closed, what happens to the:

- (a) intensities of A and B ?
- (b) intensity of C ?
- (c) current through battery?
- (d) voltage drop across A , B , and C ?
- (e) total power dissipated?

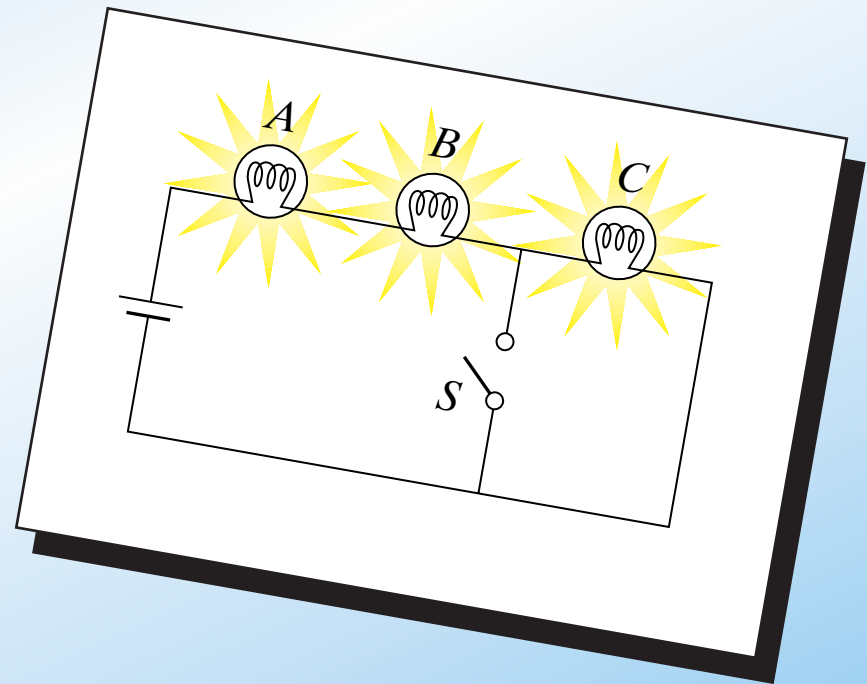

Why do we have this problem?

conventional

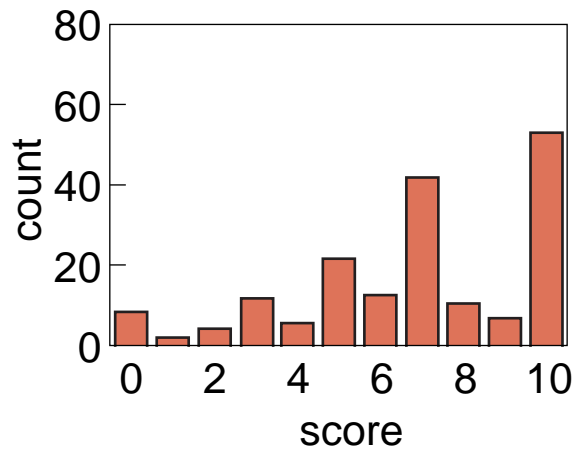

conceptual

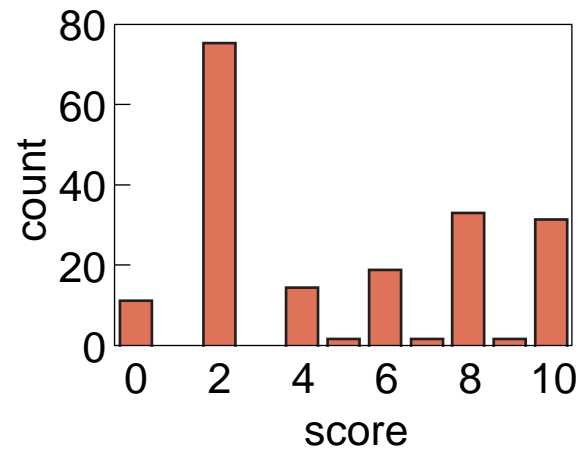

Why do we have this problem?

conventional

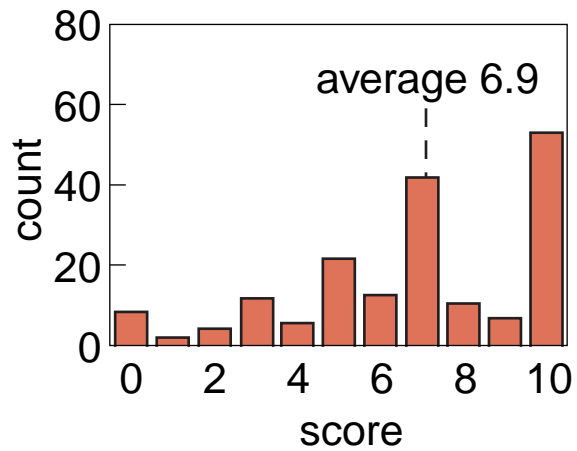

conceptual

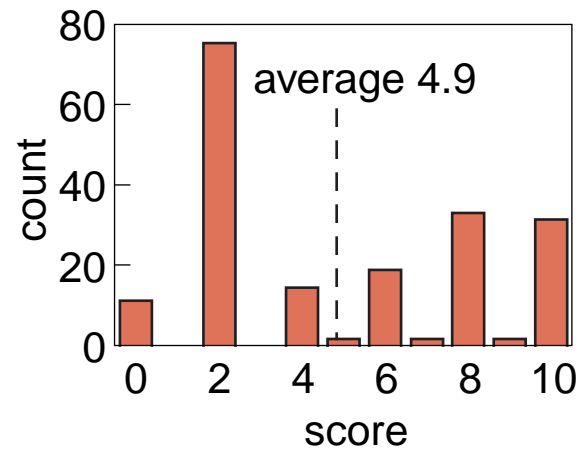

Why do we have this problem?

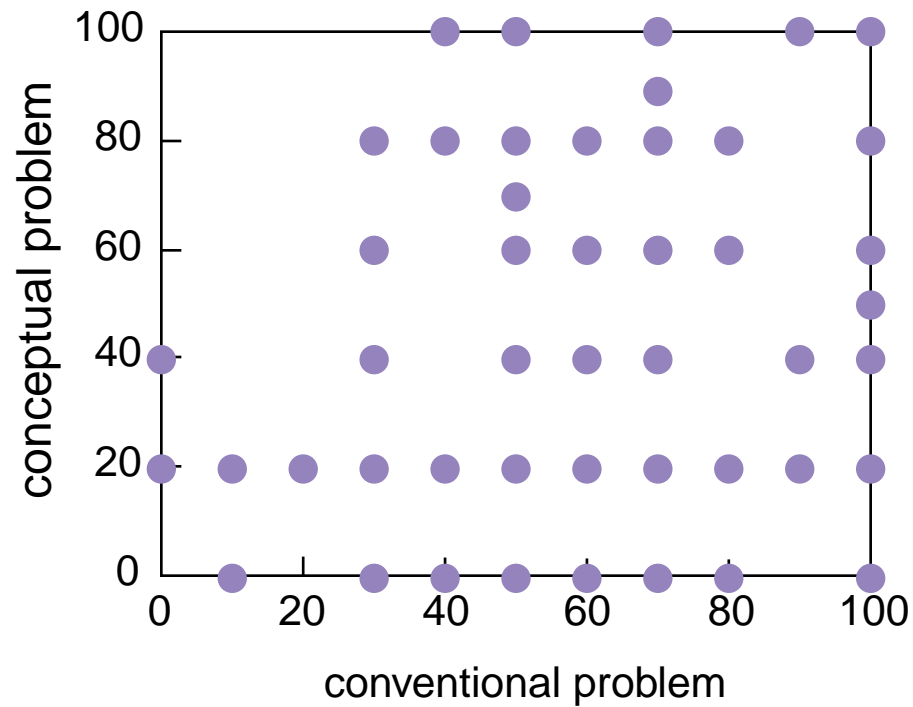

Why do we have this problem?

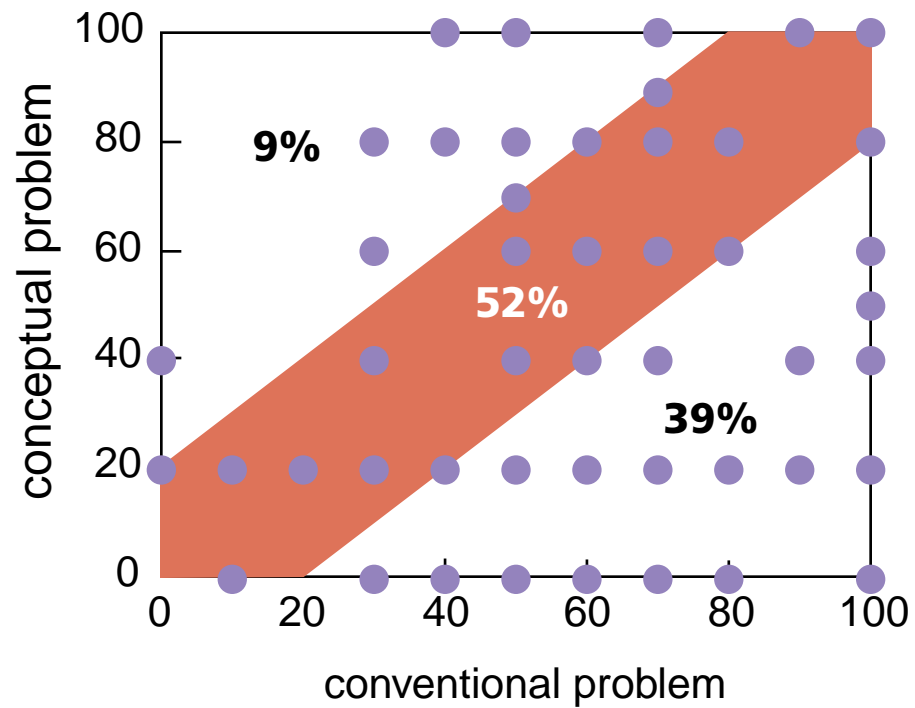



So what should we do?

Peer Instruction

Help students take more responsibility for learning!

Peer Instruction

Main features:

- ▶ **Pre-class reading**
- ▶ **In class: depth, not coverage**
- ▶ **ConcepTests**

ConcepTest

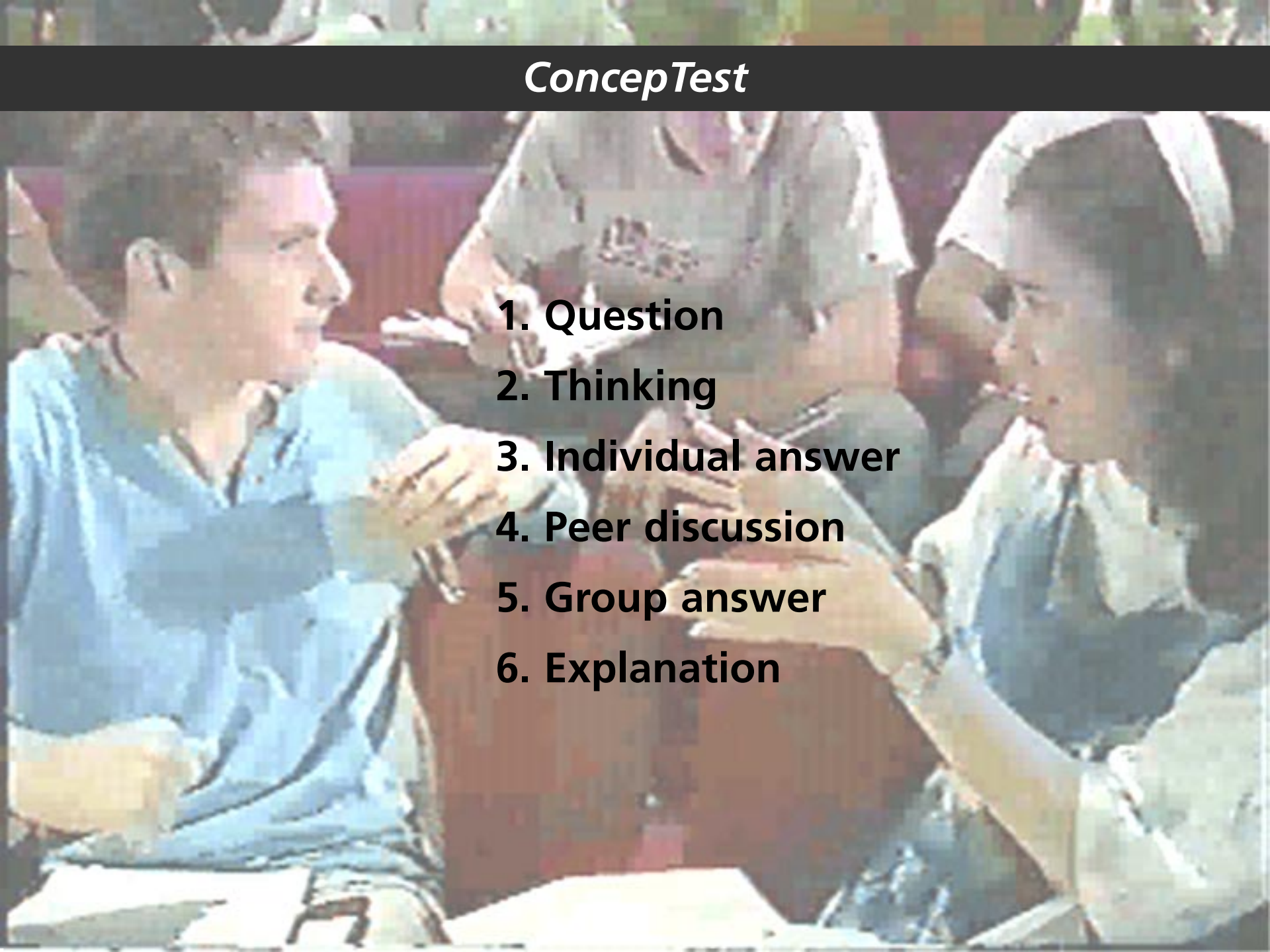
1. Question
 2. Thinking
 3. Individual answer
 4. Peer discussion
 5. Group answer
 6. Explanation
- 



Is it any good?

Results

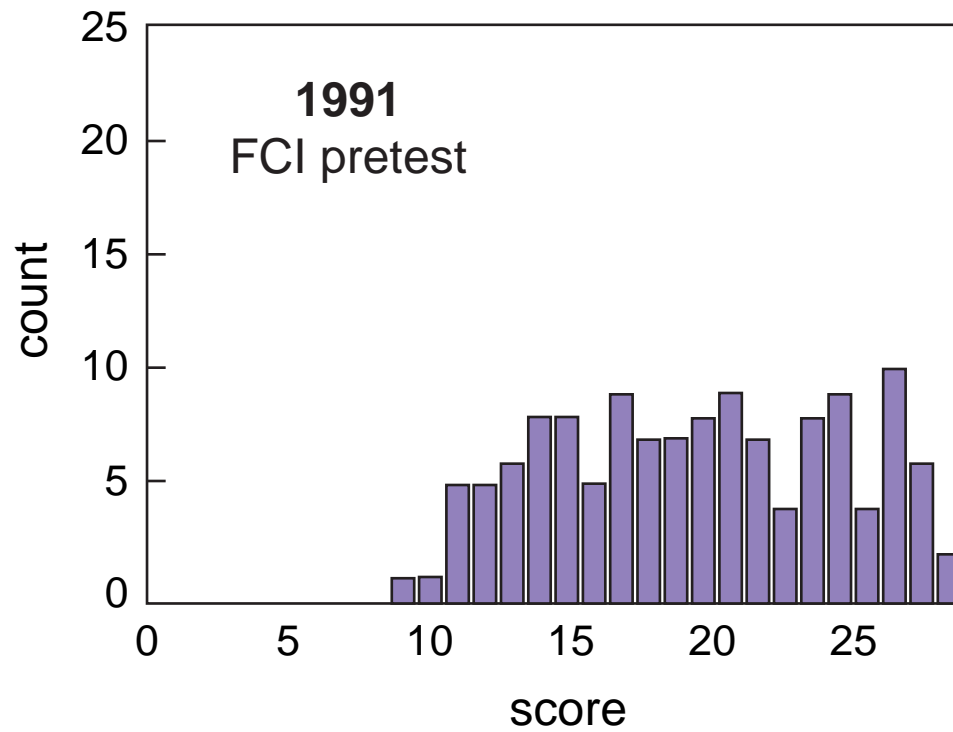

Results

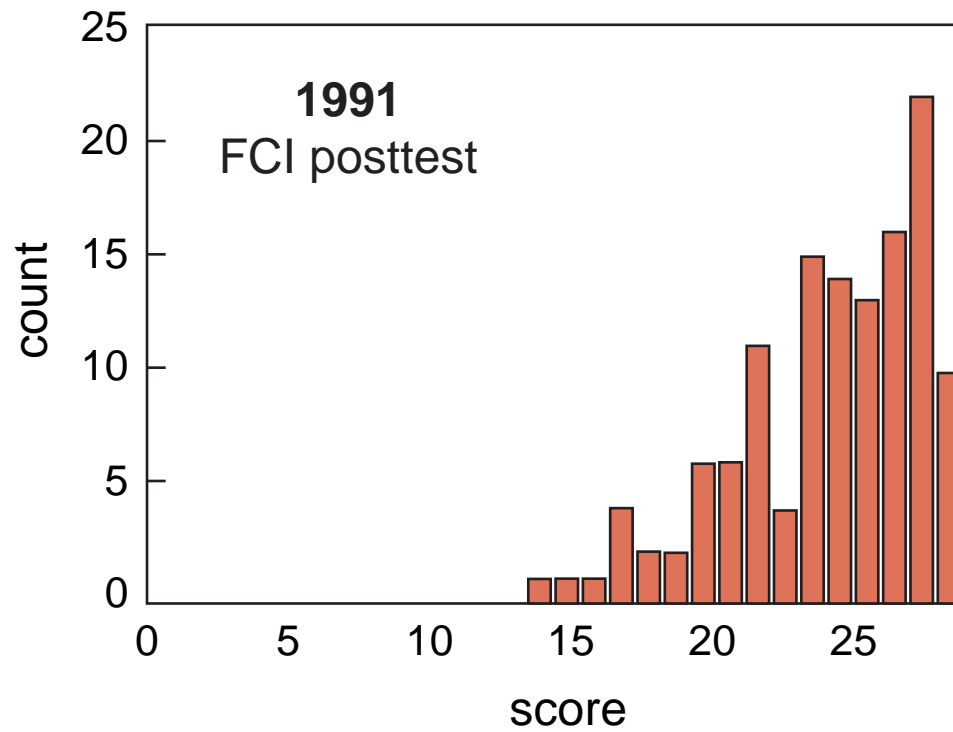

Results

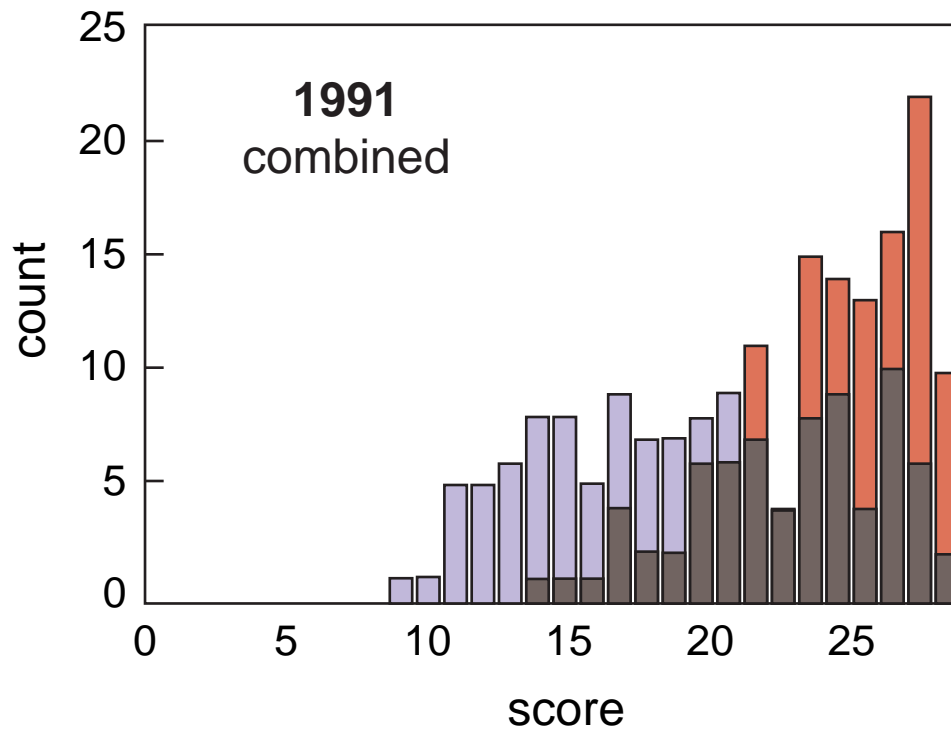

Results

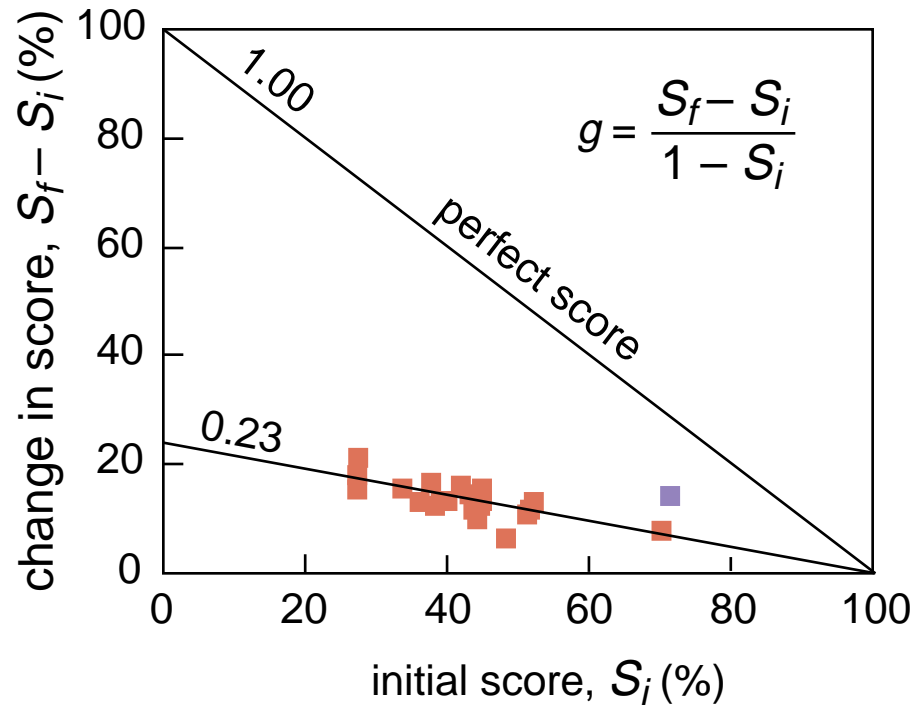

Results

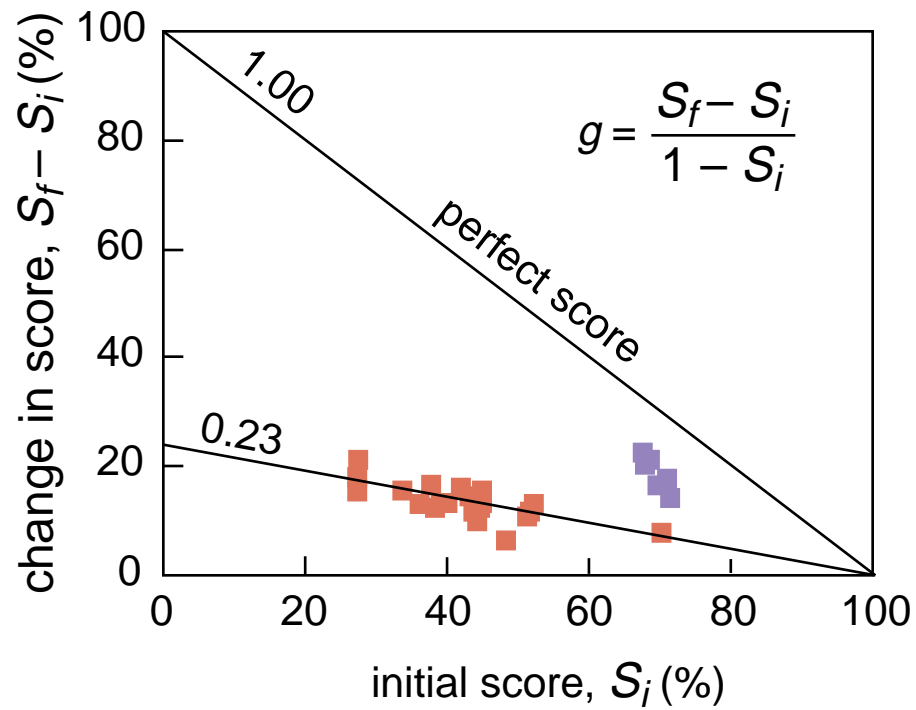

Results

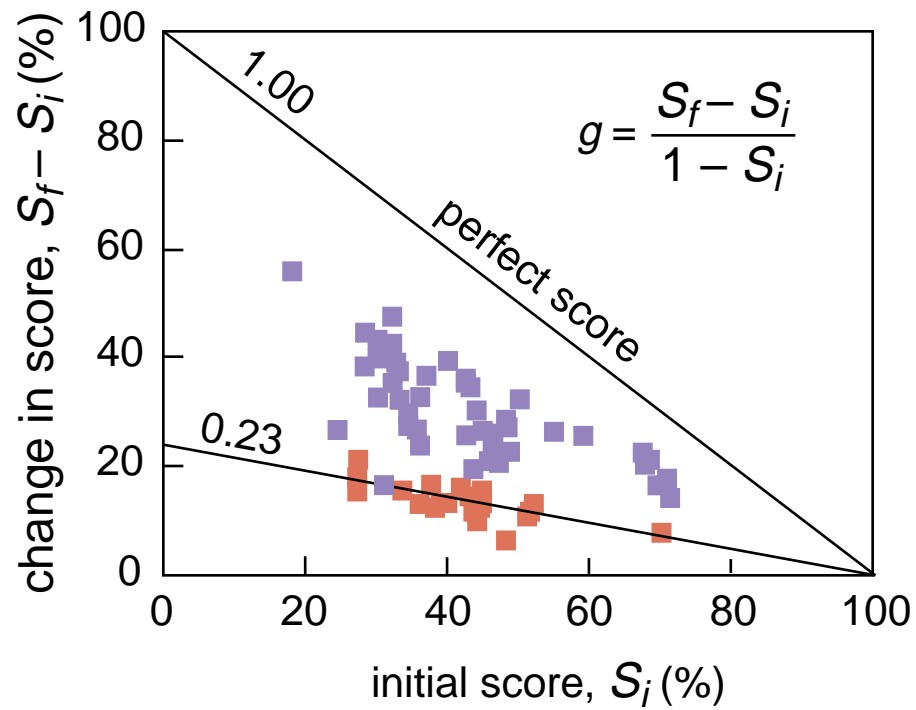

Results

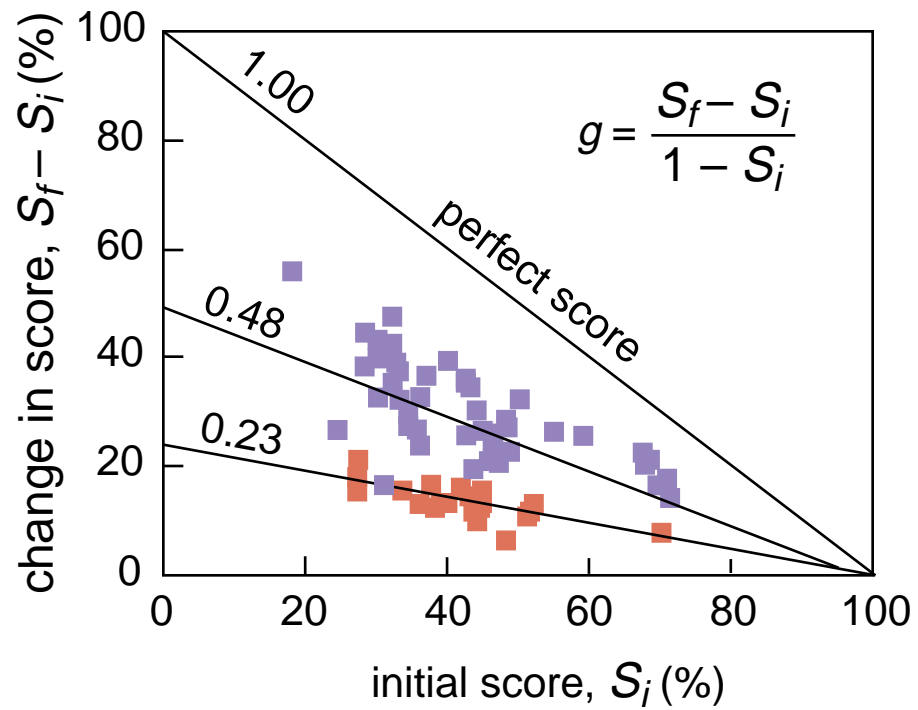

Results

What about problem solving...?

Results

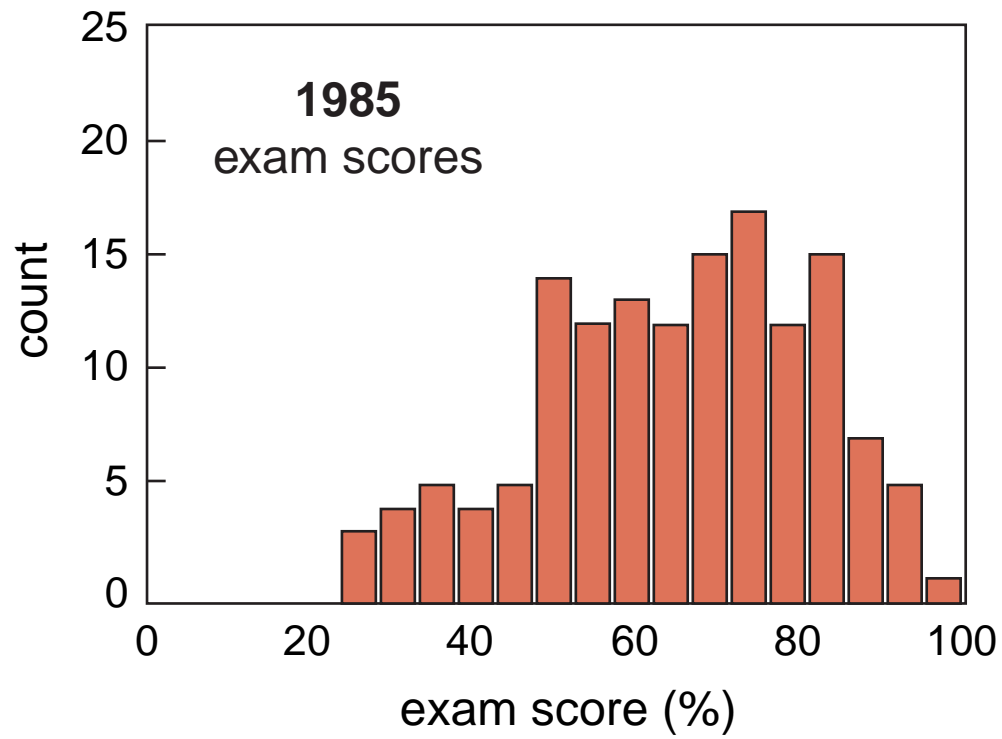

Results

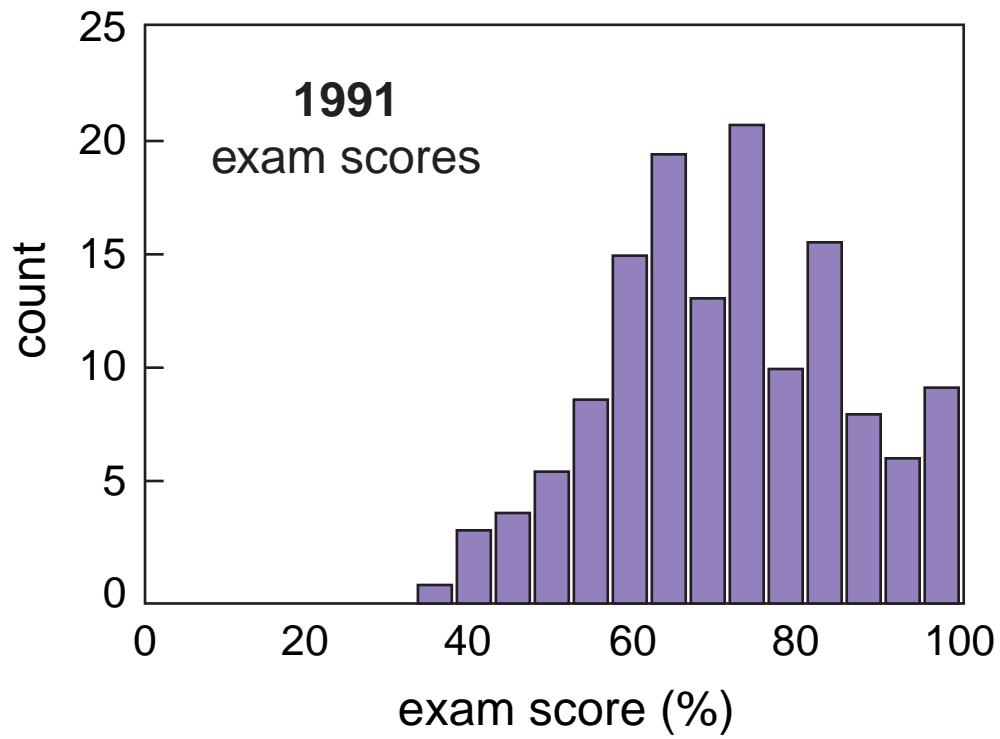

Results

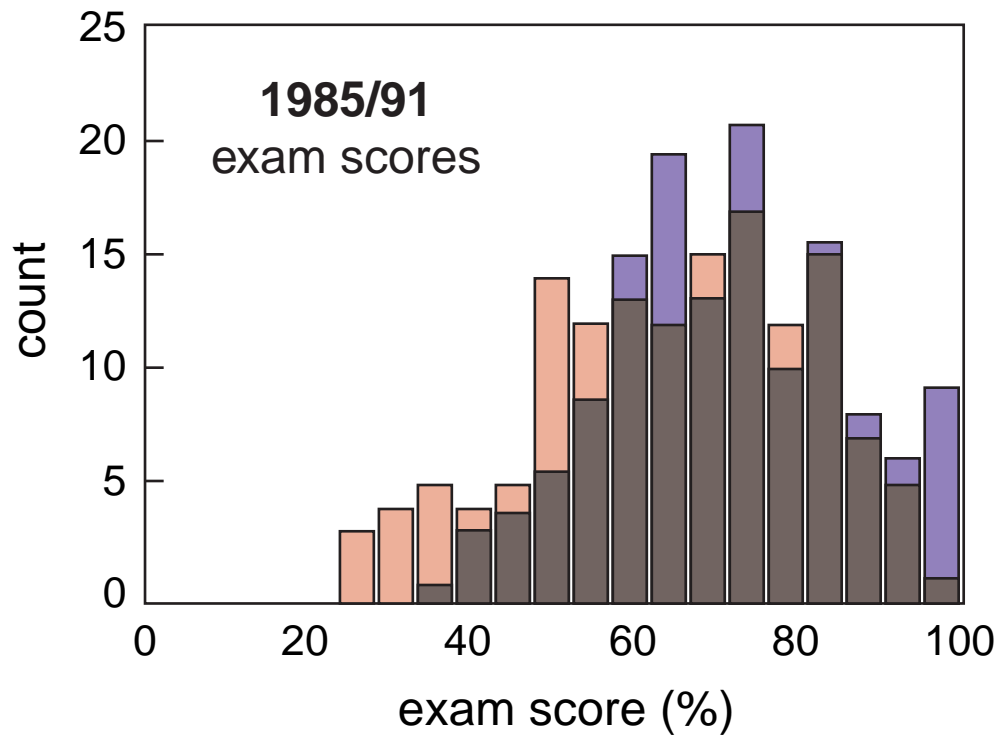

Results

**So better understanding leads to better
problem solving!**

Results

So better understanding leads to better problem solving!

(but “good” problem solving doesn’t always indicate understanding!)

Conclusion

**Let's not forget the base
of the pyramid!**

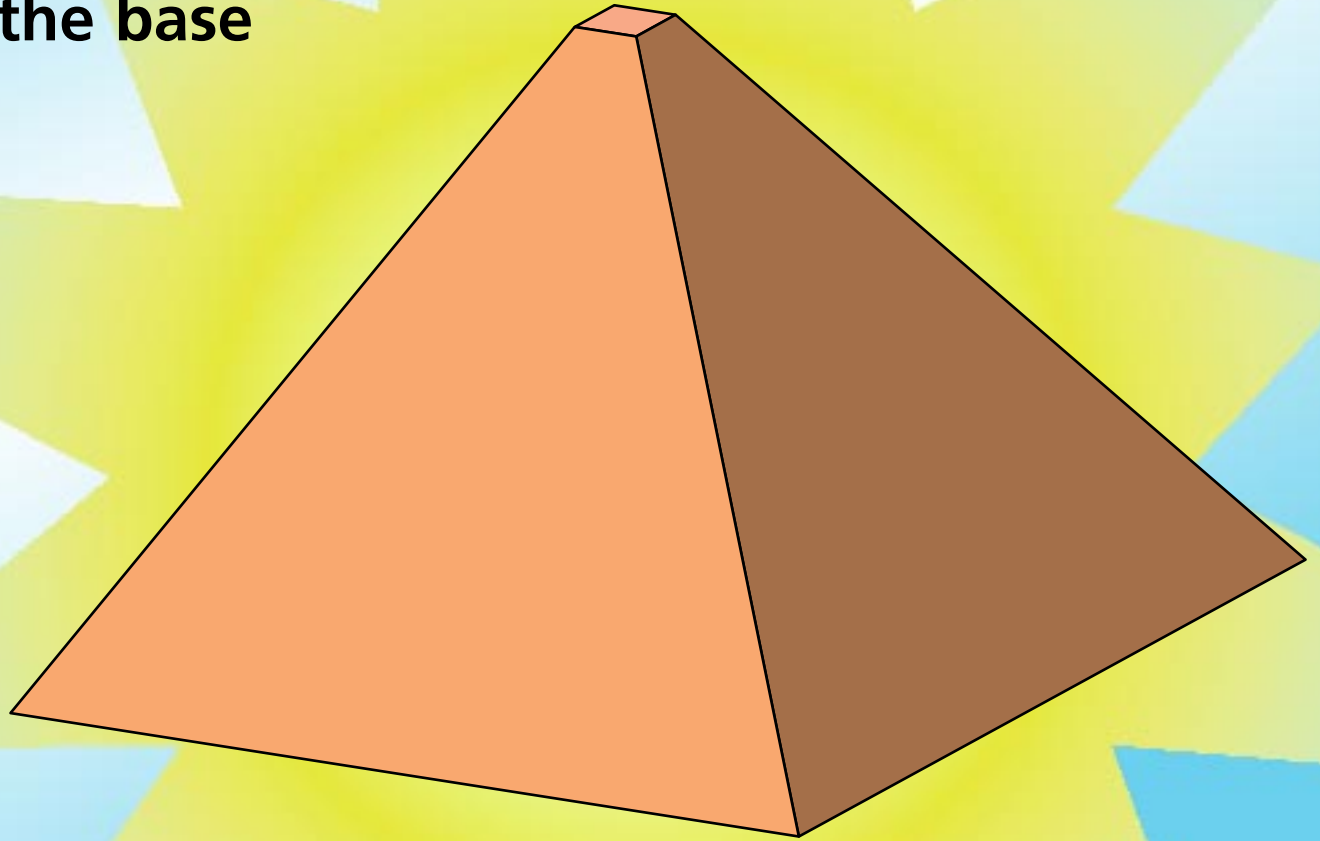

Conclusion

**Let's give them something
of value!**

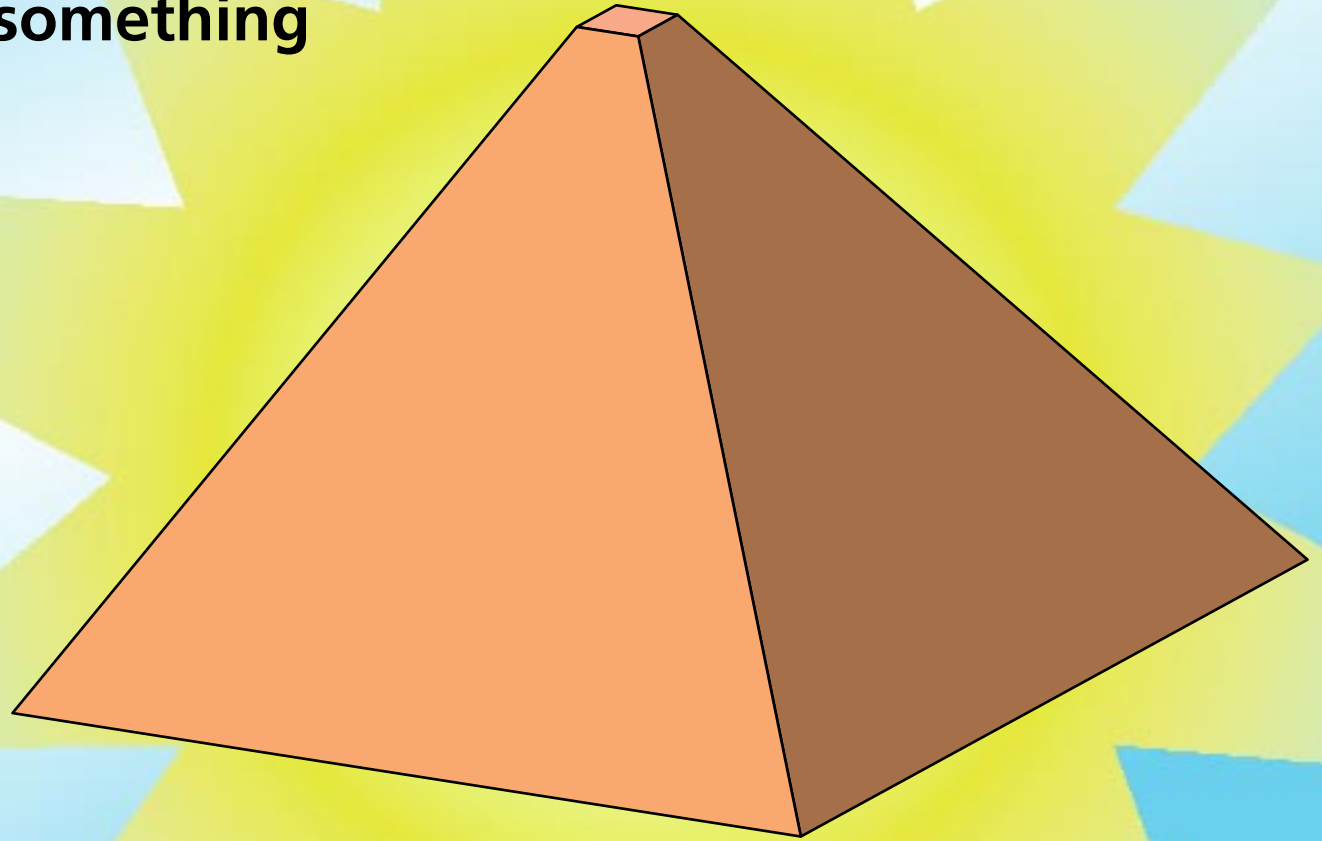

Funding

National Science Foundation

**For a copy of this talk and
additional information:**

<http://mazur-www.harvard.edu>