



FROM SEMICONDUCTOR TO METAL IN A FLASH

femtosecond electron and lattice dynamics

Eli Glezer

Li Huang

Paul Callan

University of Minnesota

25 February 1997

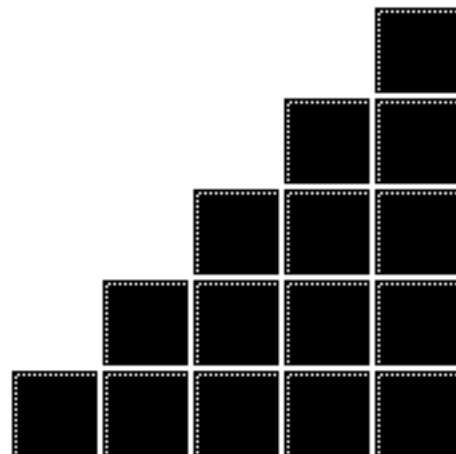

INTRODUCTION

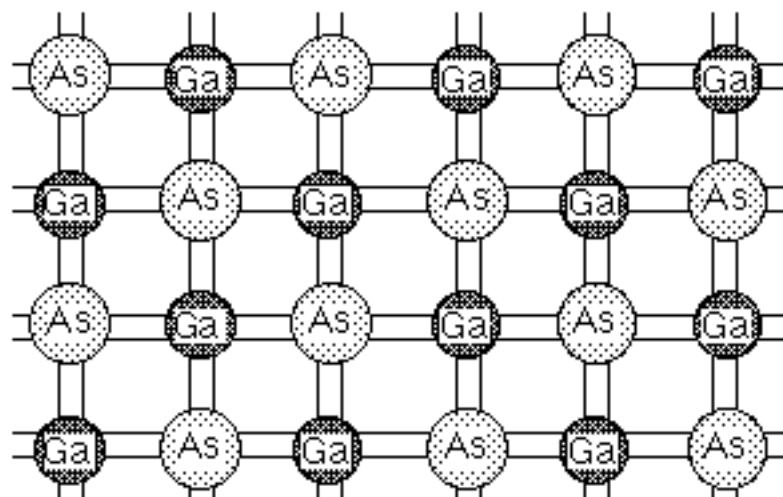

how does light melt a solid?



INTRODUCTION

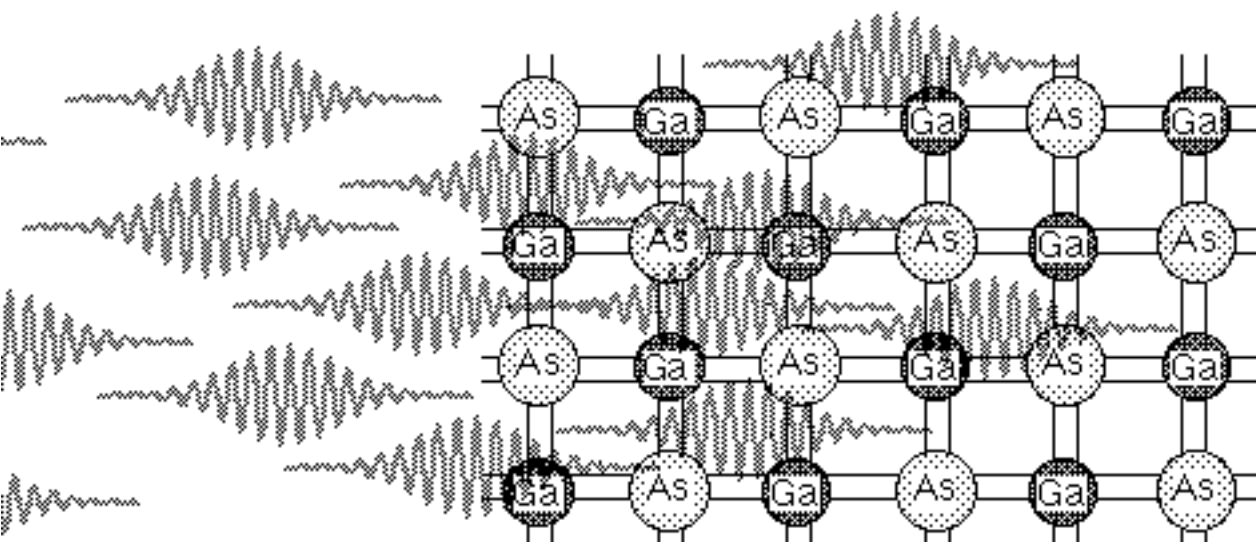

photons excite valence electrons...



INTRODUCTION

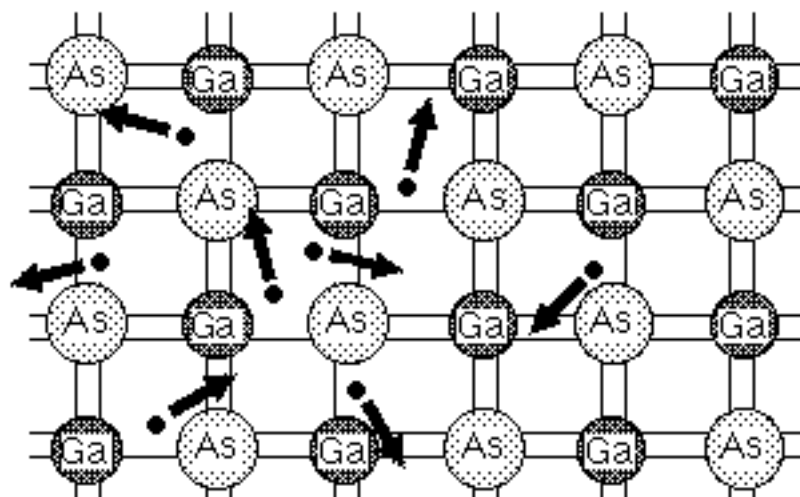

...and create free electrons...



INTRODUCTION

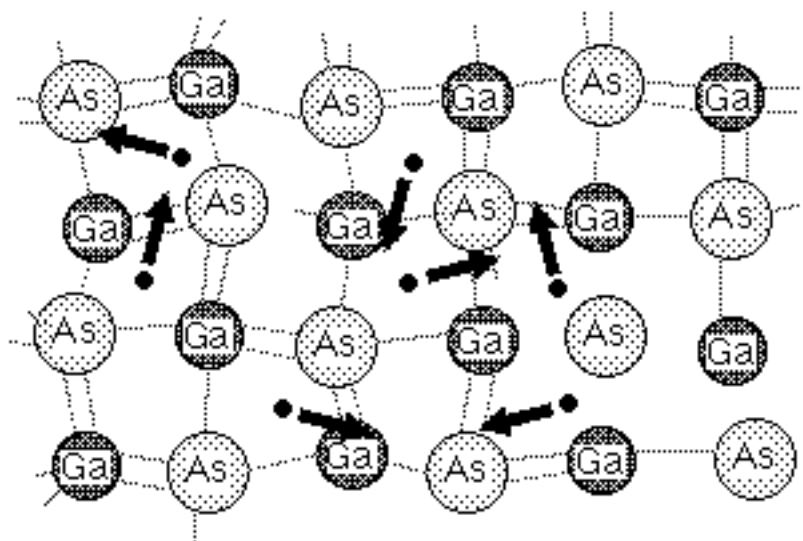

... causing electronic & structural changes...



INTRODUCTION

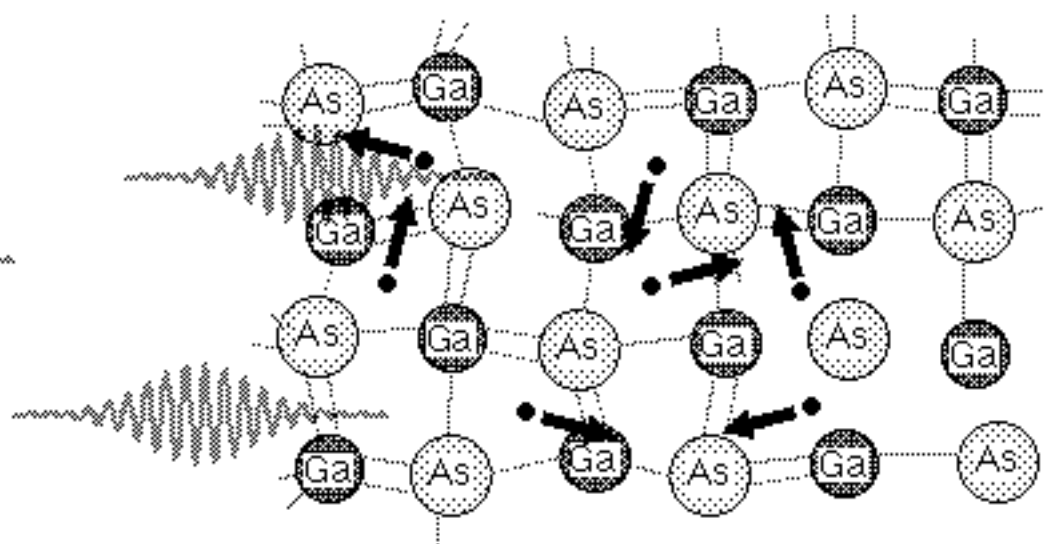

... which we measure with another pulse...



INTRODUCTION

structure

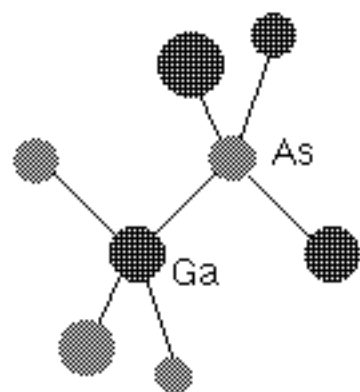

INTRODUCTION

structure

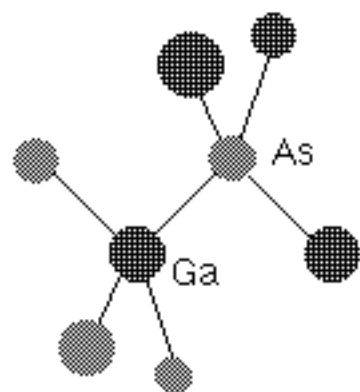

INTRODUCTION

structure

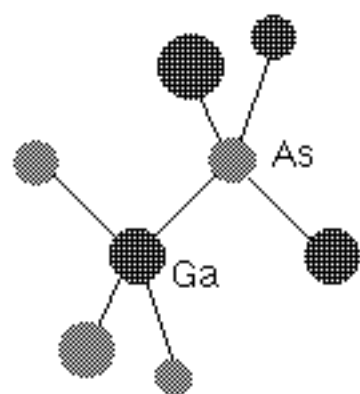

bandstructure

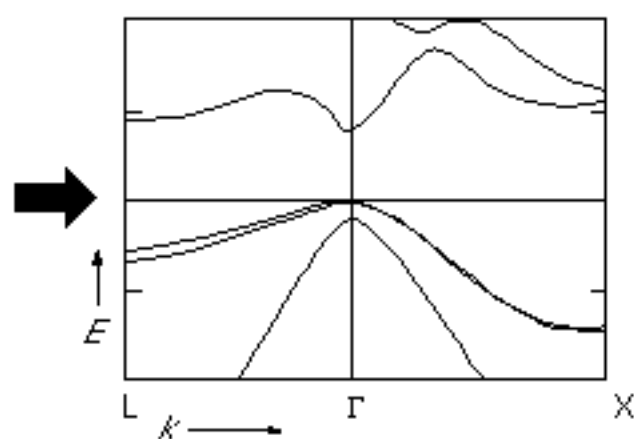

INTRODUCTION

structure

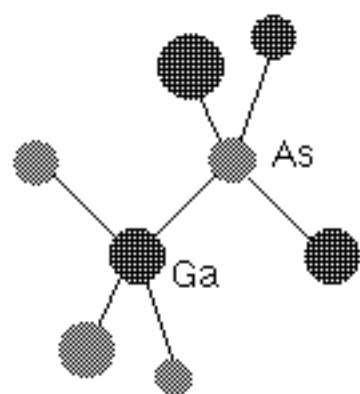

bandstructure

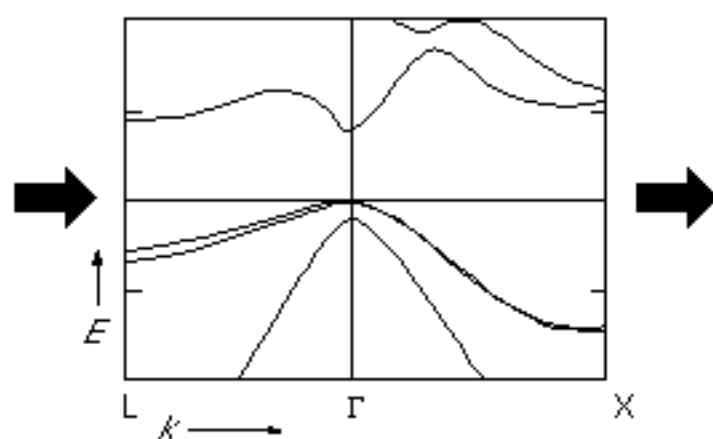

INTRODUCTION

structure

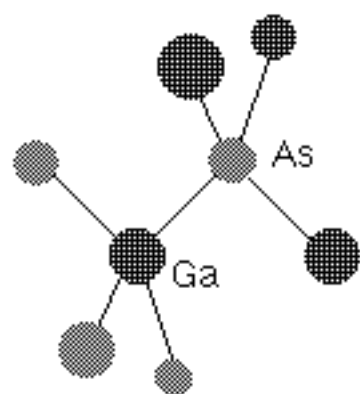

bandstructure

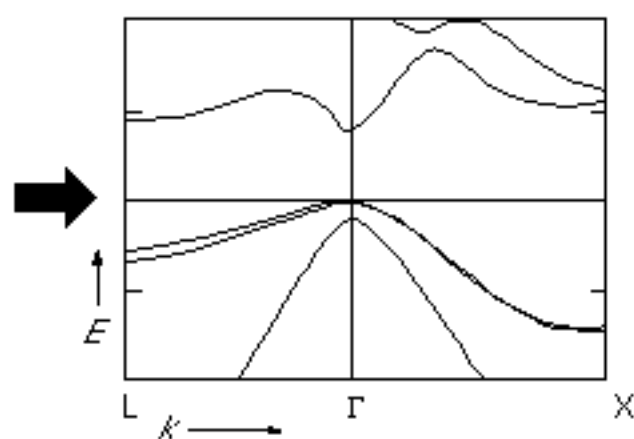

dielectric function

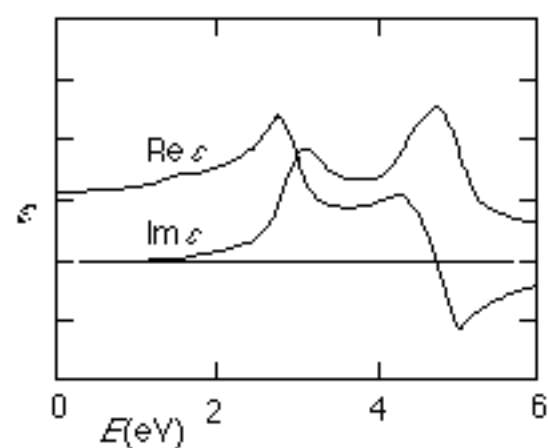

INTRODUCTION

structure

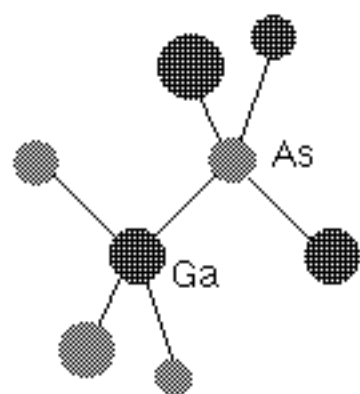

bandstructure

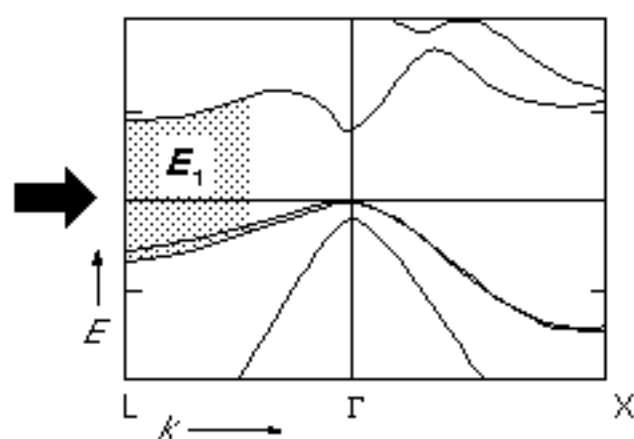

dielectric function

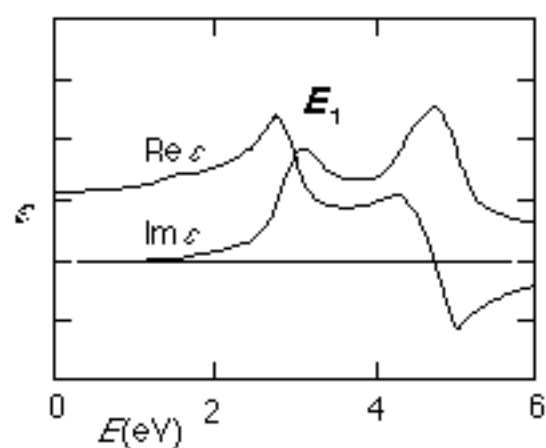

INTRODUCTION

structure

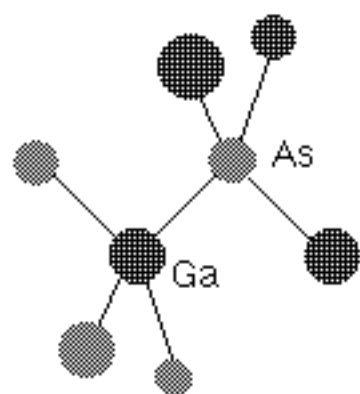

bandstructure

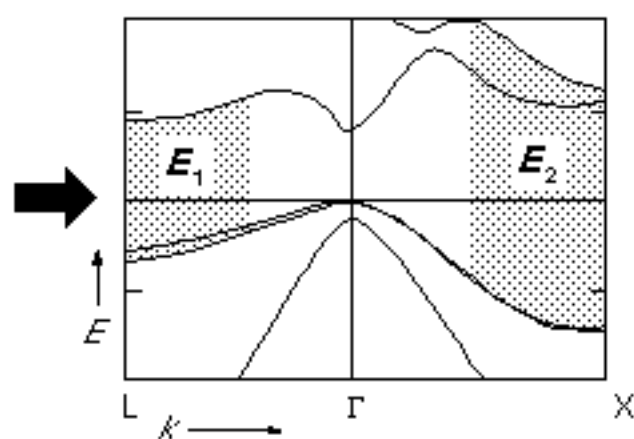

dielectric function

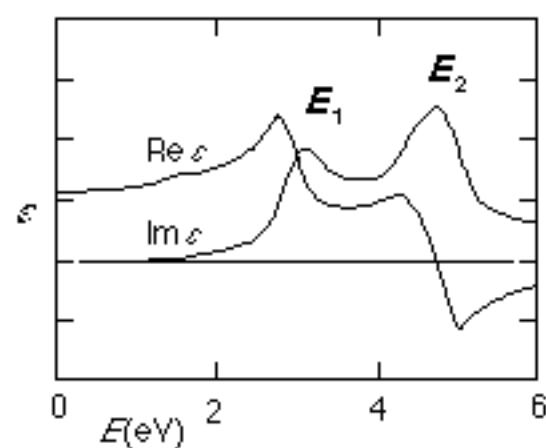

INTRODUCTION

structure

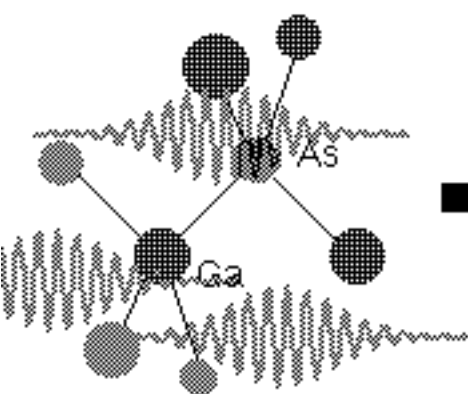

bandstructure

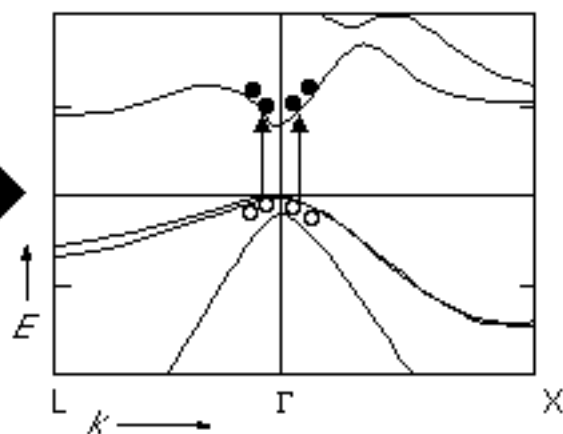

dielectric function

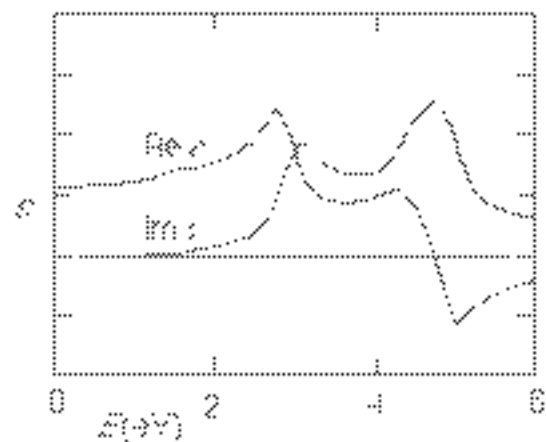

70 fs, 10^{16} W/m²

10^{20} - 10^{22} cm⁻³



INTRODUCTION

structure

bandstructure

dielectric function

?

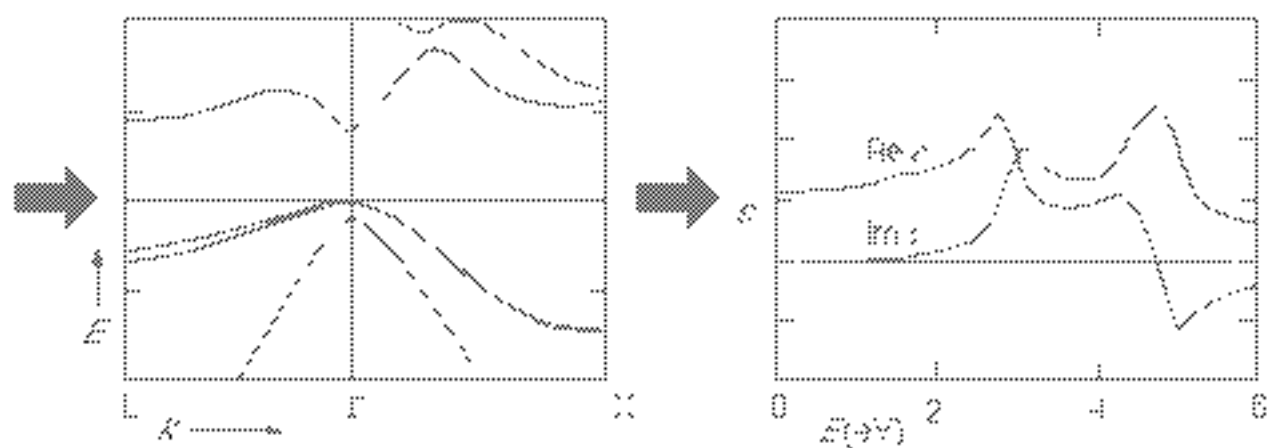

INTRODUCTION

structure

bandstructure

dielectric function

?

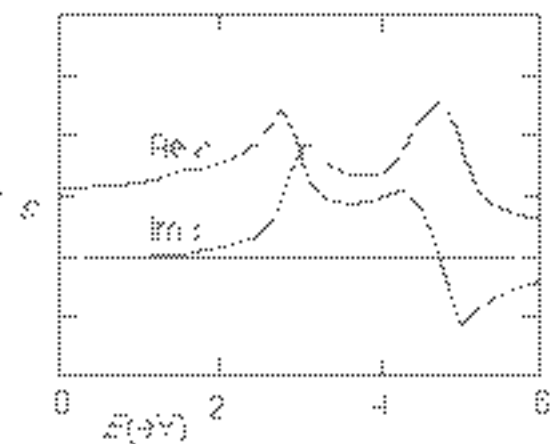
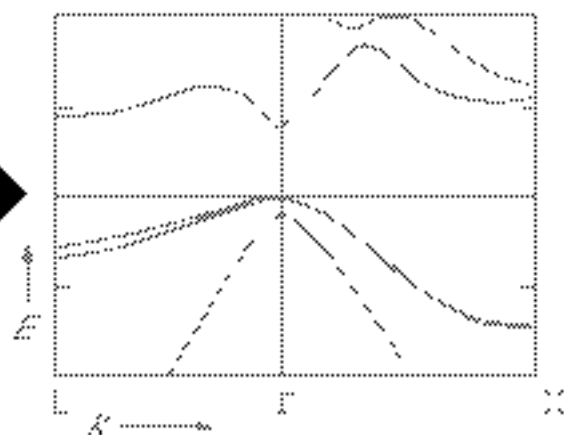

INTRODUCTION

structure

?



bandstructure

?



dielectric function

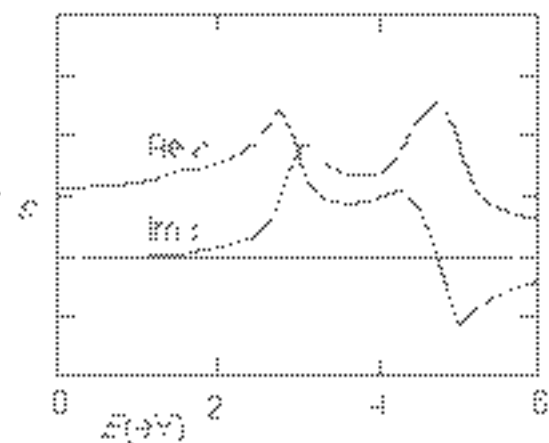
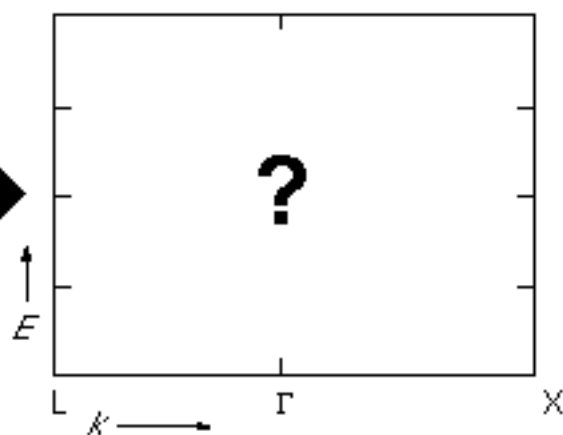

INTRODUCTION

structure

?



bandstructure

?



dielectric function

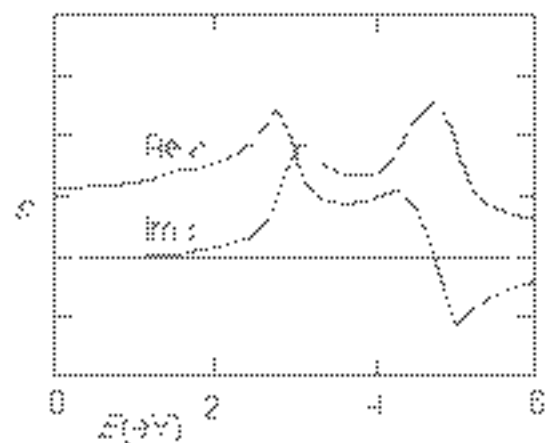
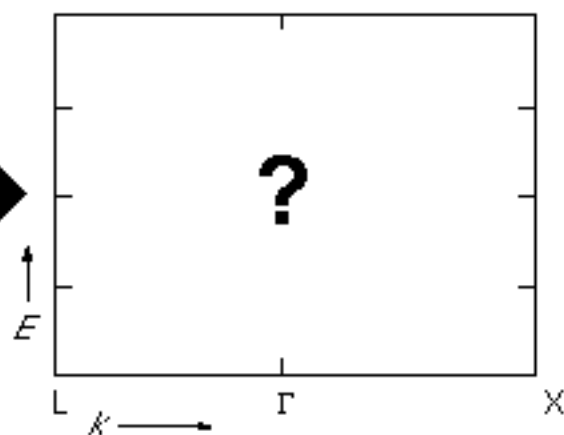

INTRODUCTION

structure

?



bandstructure

?



dielectric function

?

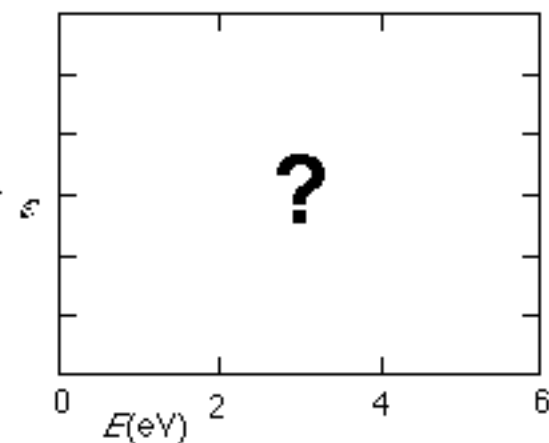
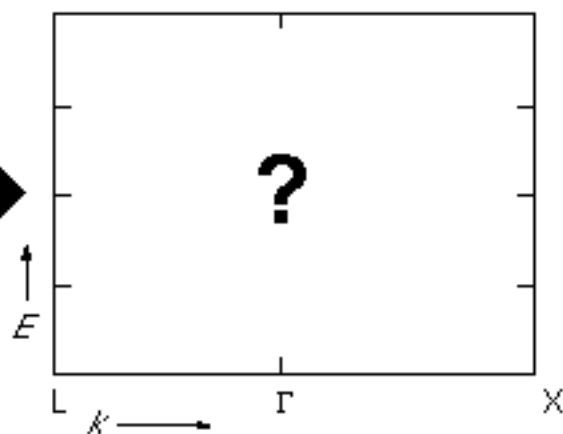

INTRODUCTION

structure

?

bandstructure

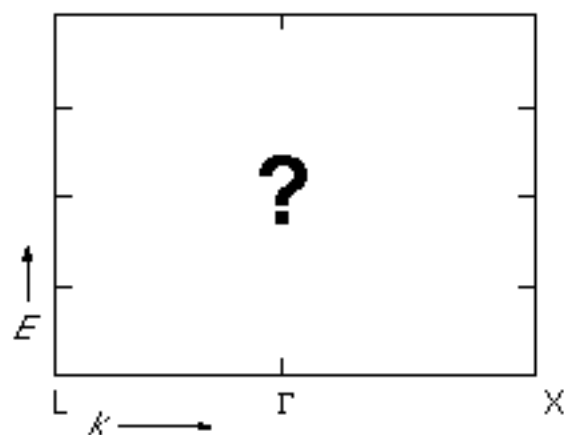

dielectric function

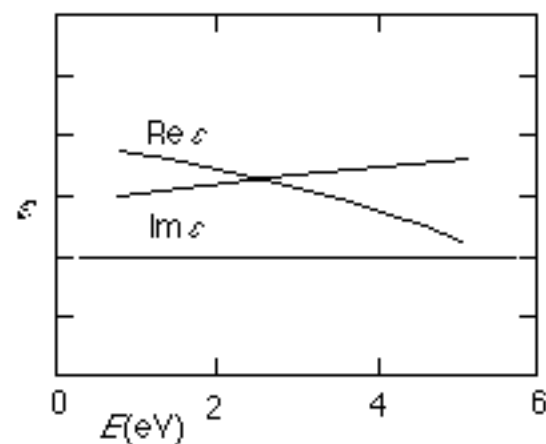

INTRODUCTION

structure

?

bandstructure

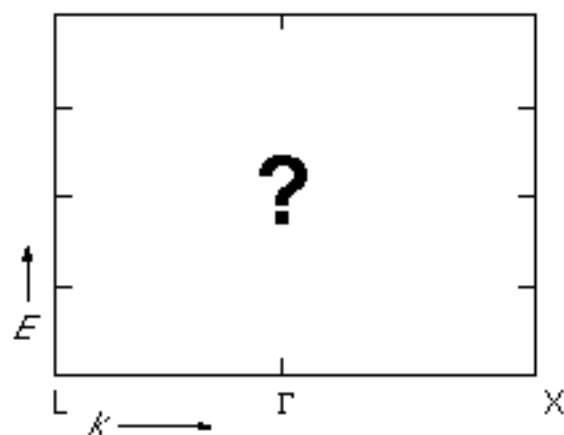

dielectric function

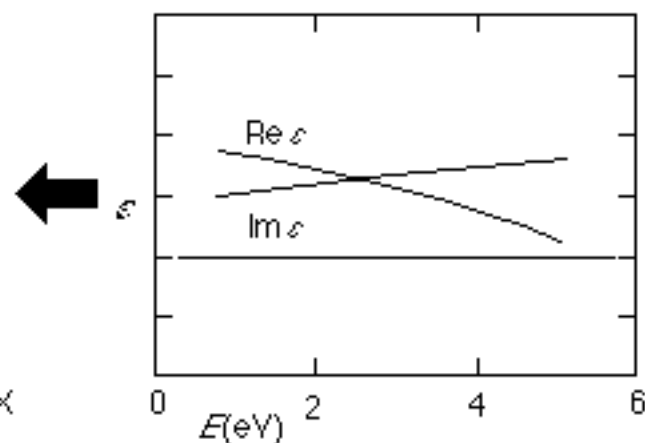

INTRODUCTION

structure

bandstructure

dielectric function

?

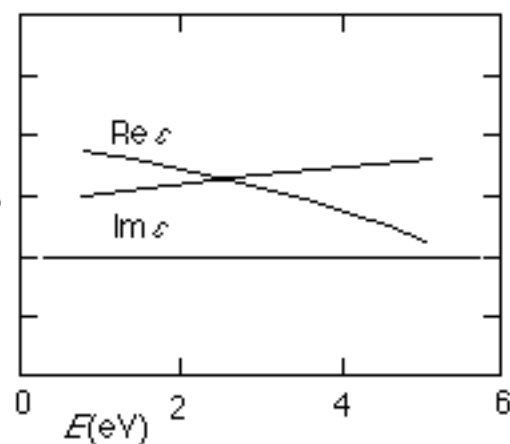
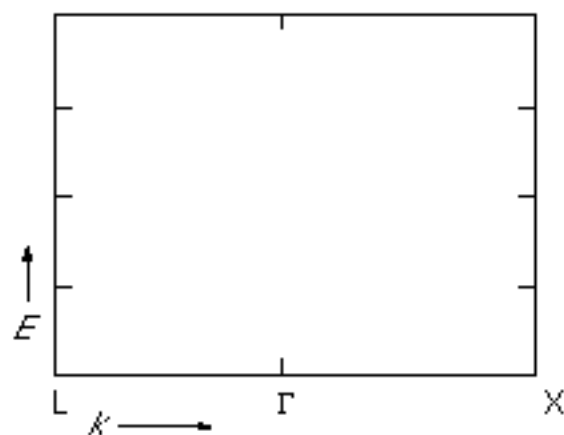

INTRODUCTION

structure

bandstructure

dielectric function

?

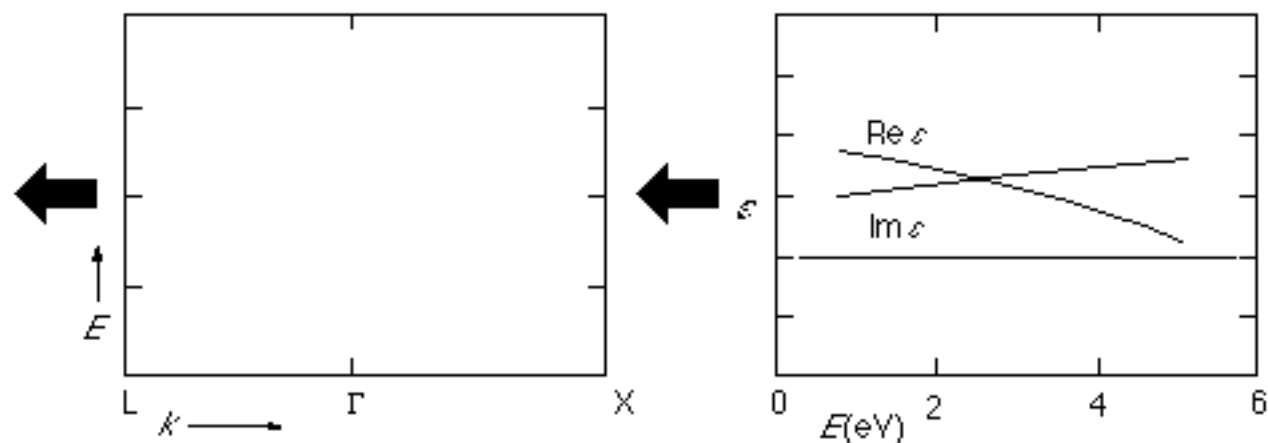

INTRODUCTION

structure

bandstructure

dielectric function

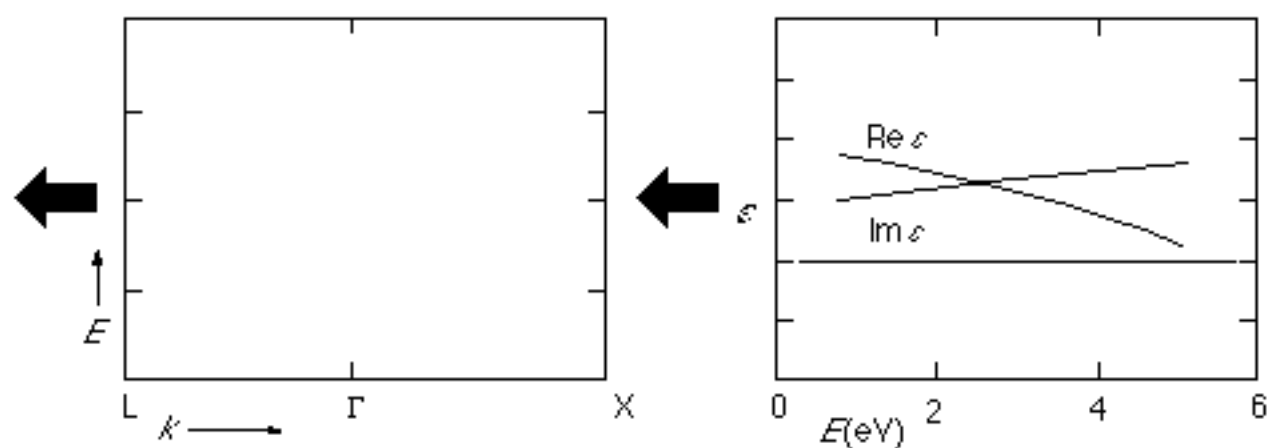

- ① Method
- ② Results
- ③ Discussion



2.2 eV DIELECTRIC CONSTANT

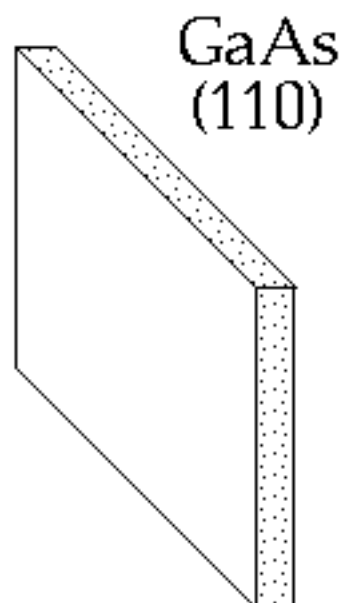

2.2 eV DIELECTRIC CONSTANT

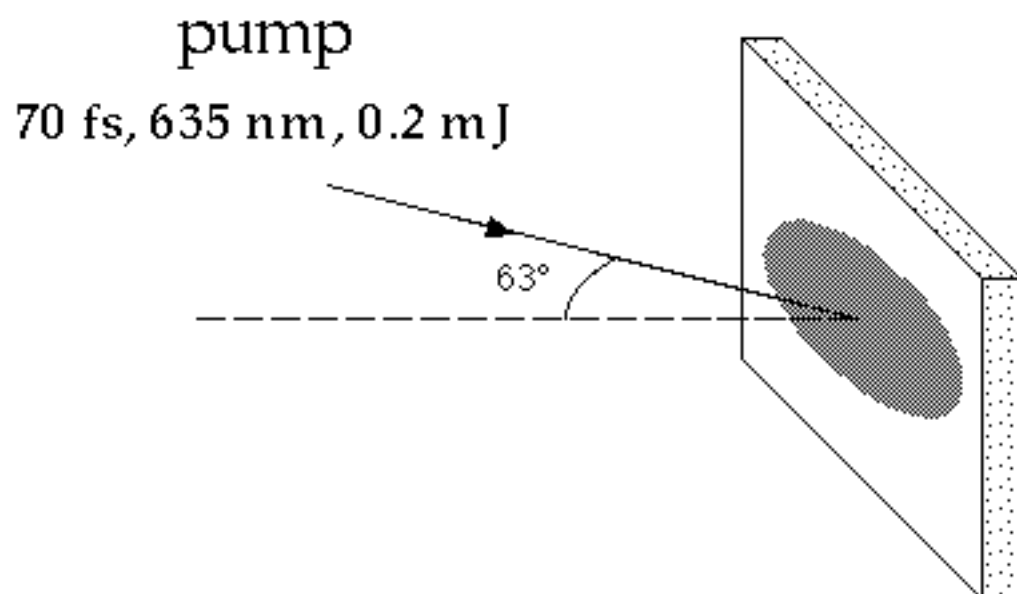

2.2 eV DIELECTRIC CONSTANT

probes

350–1100 nm, $< 0.1 \mu\text{J}$

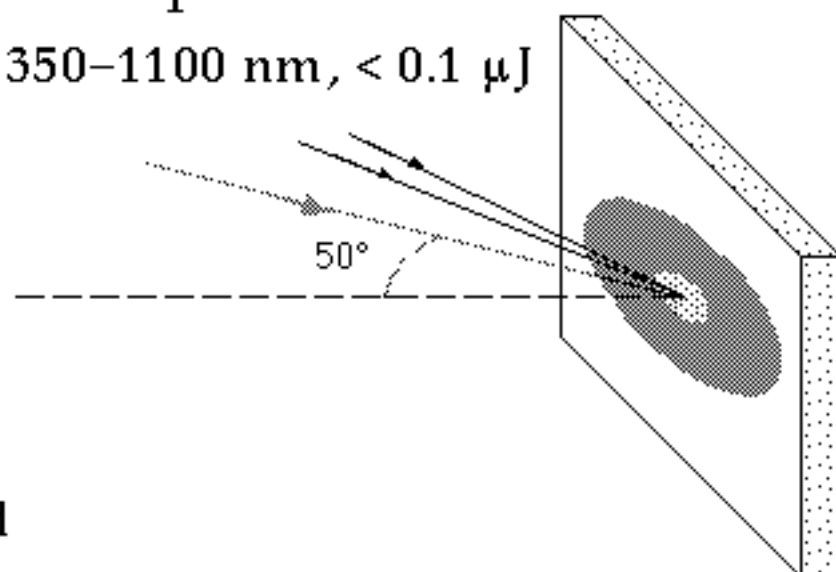

all beams
p-polarized



2.2 eV DIELECTRIC CONSTANT

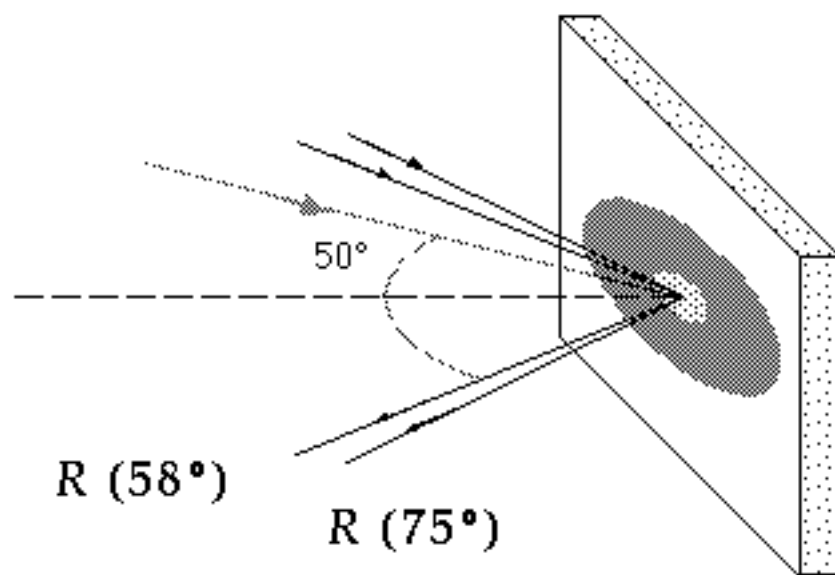

2.2 eV DIELECTRIC CONSTANT

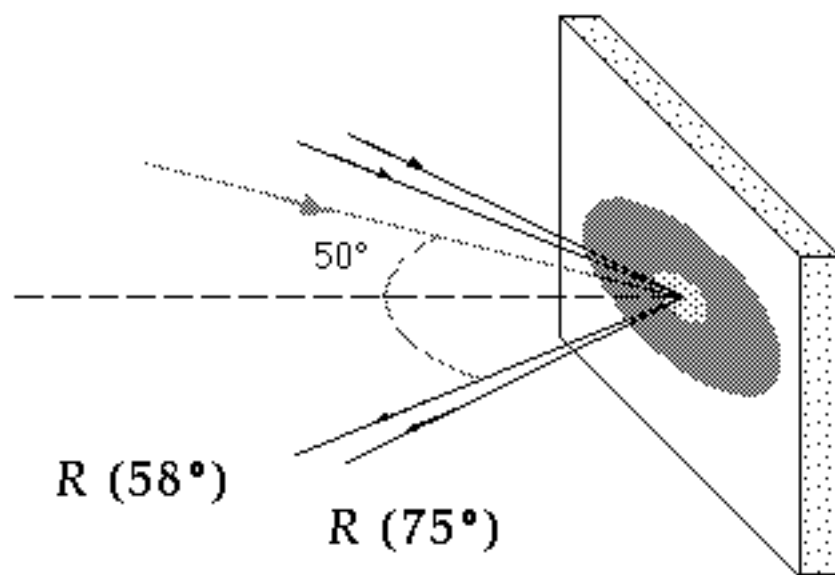

Fresnel
equations



2.2 eV DIELECTRIC CONSTANT

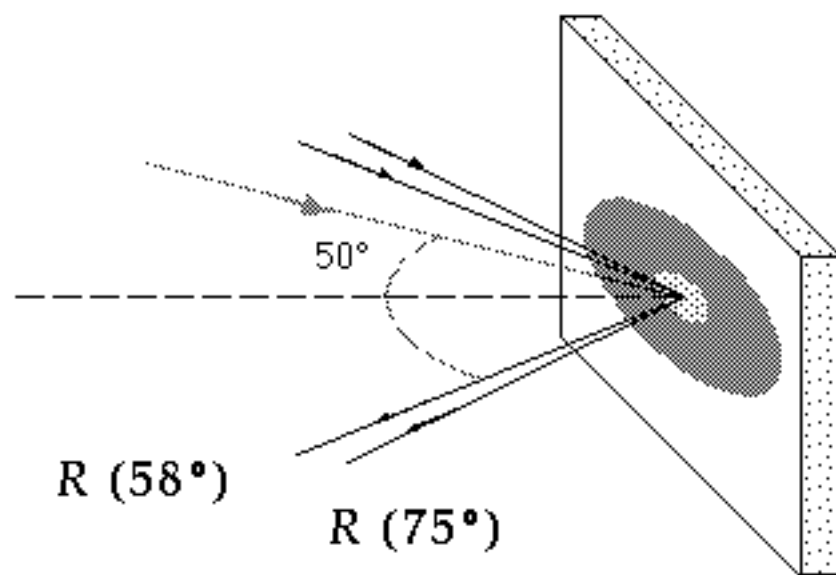

↓
Fresnel
equations

→ $\text{Re } \epsilon(\omega), \text{Im } \epsilon(\omega)$



SETUP

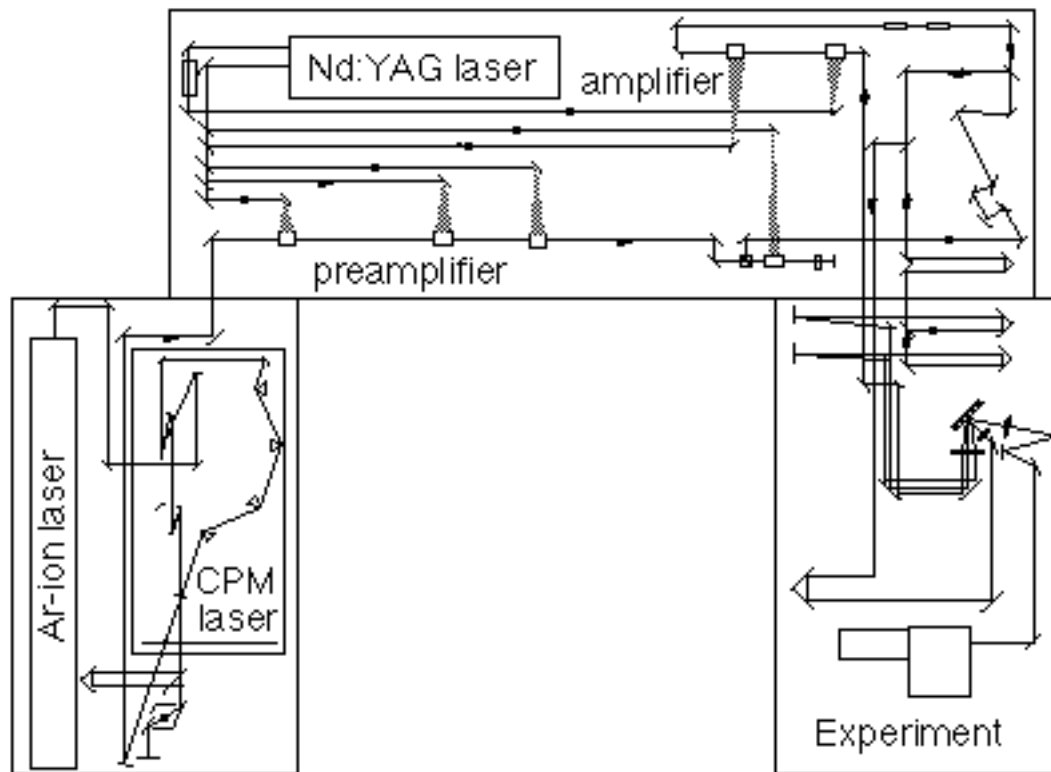

- ➊ Method
- ➋ Results
- ➌ Discussion



LOW FLUENCE DATA

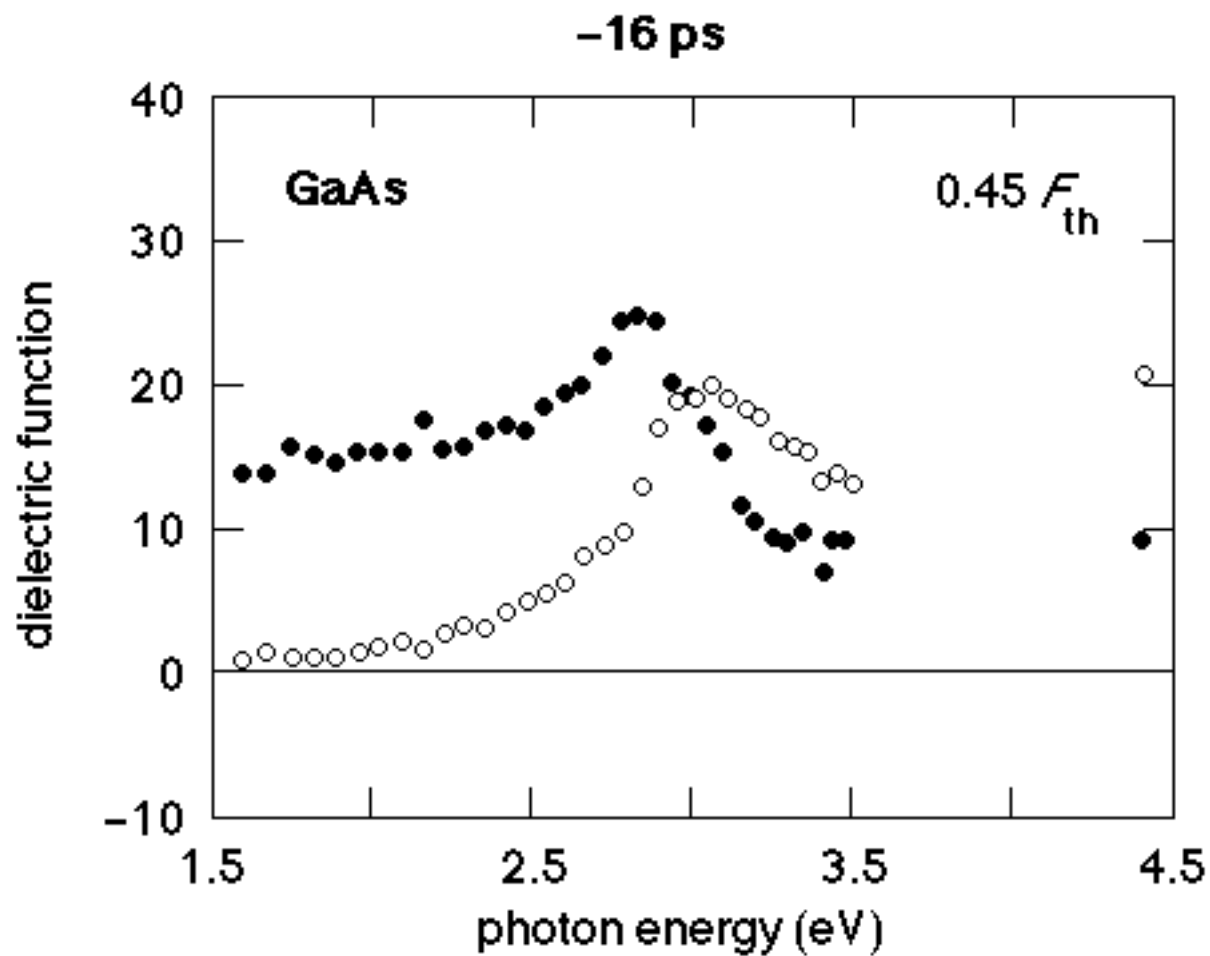

LOW FLUENCE DATA

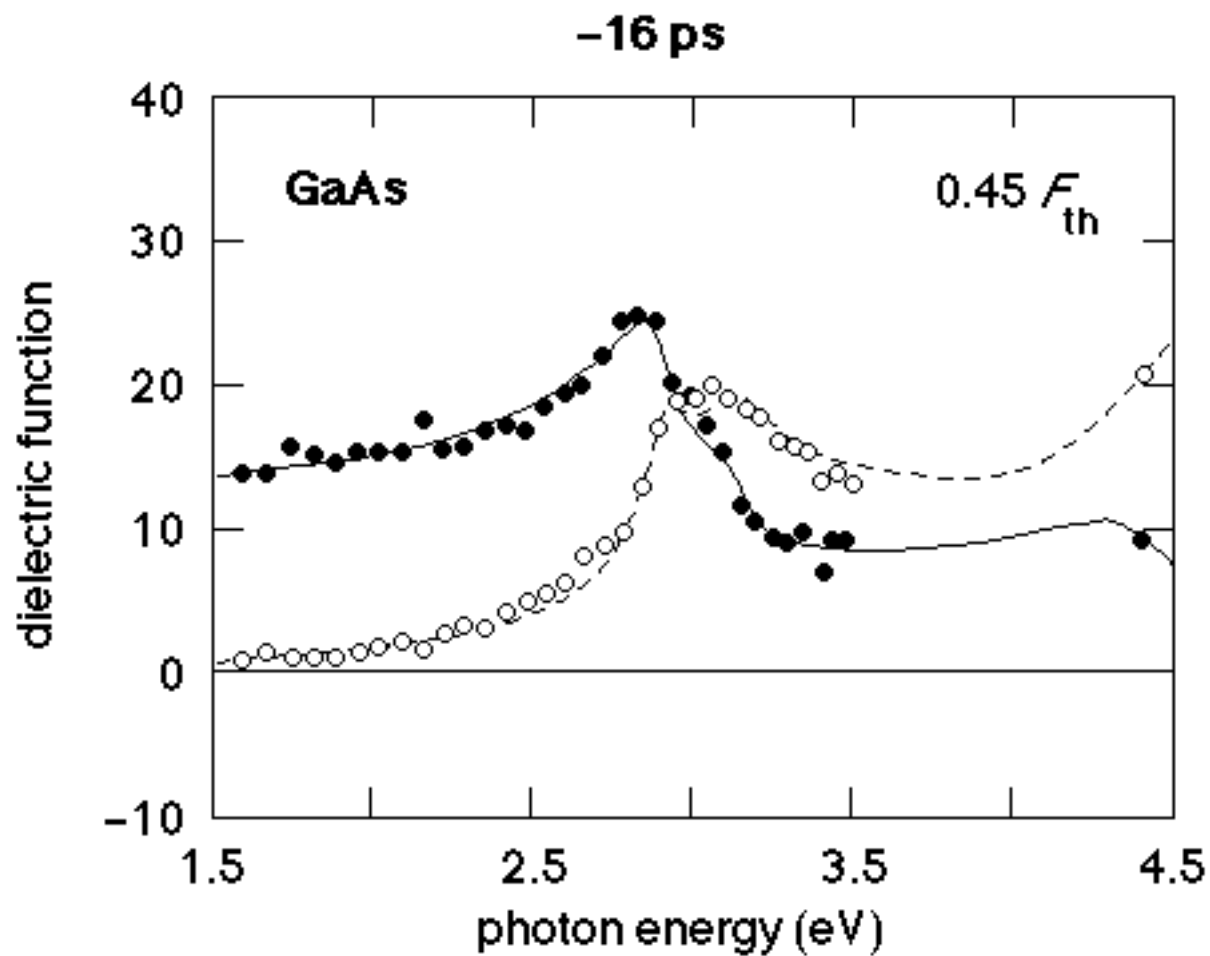

LOW FLUENCE DATA

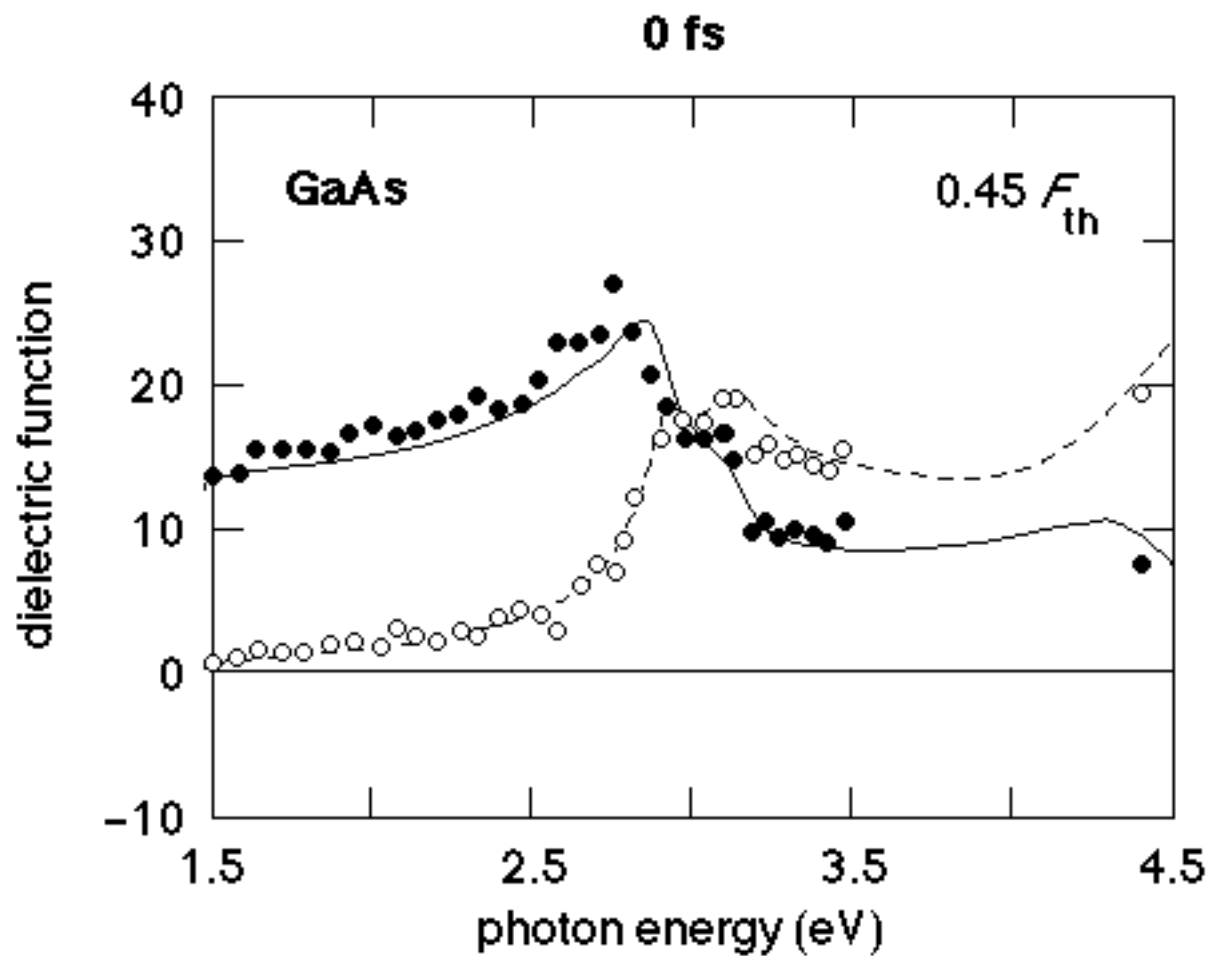

LOW FLUENCE DATA

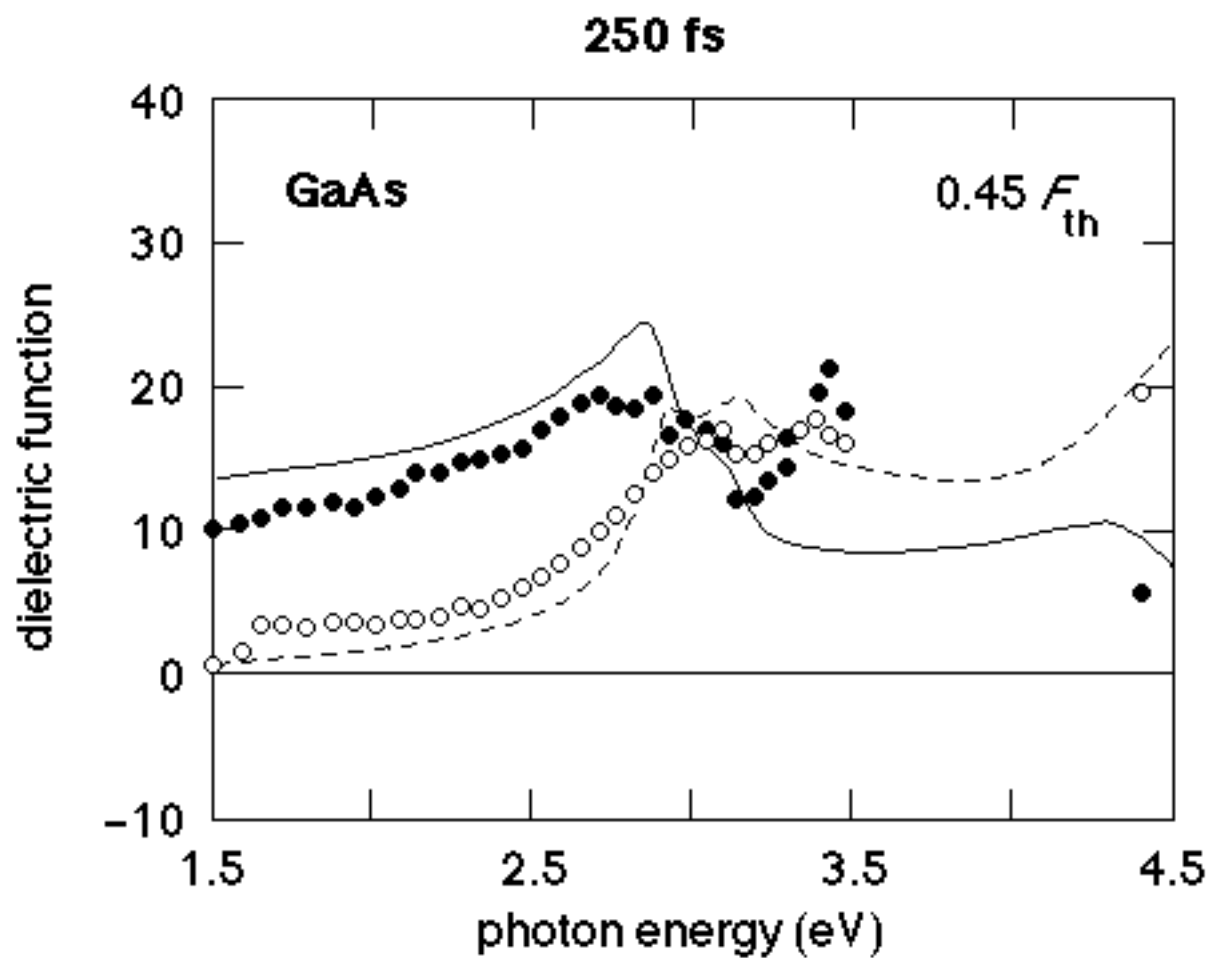

LOW FLUENCE DATA

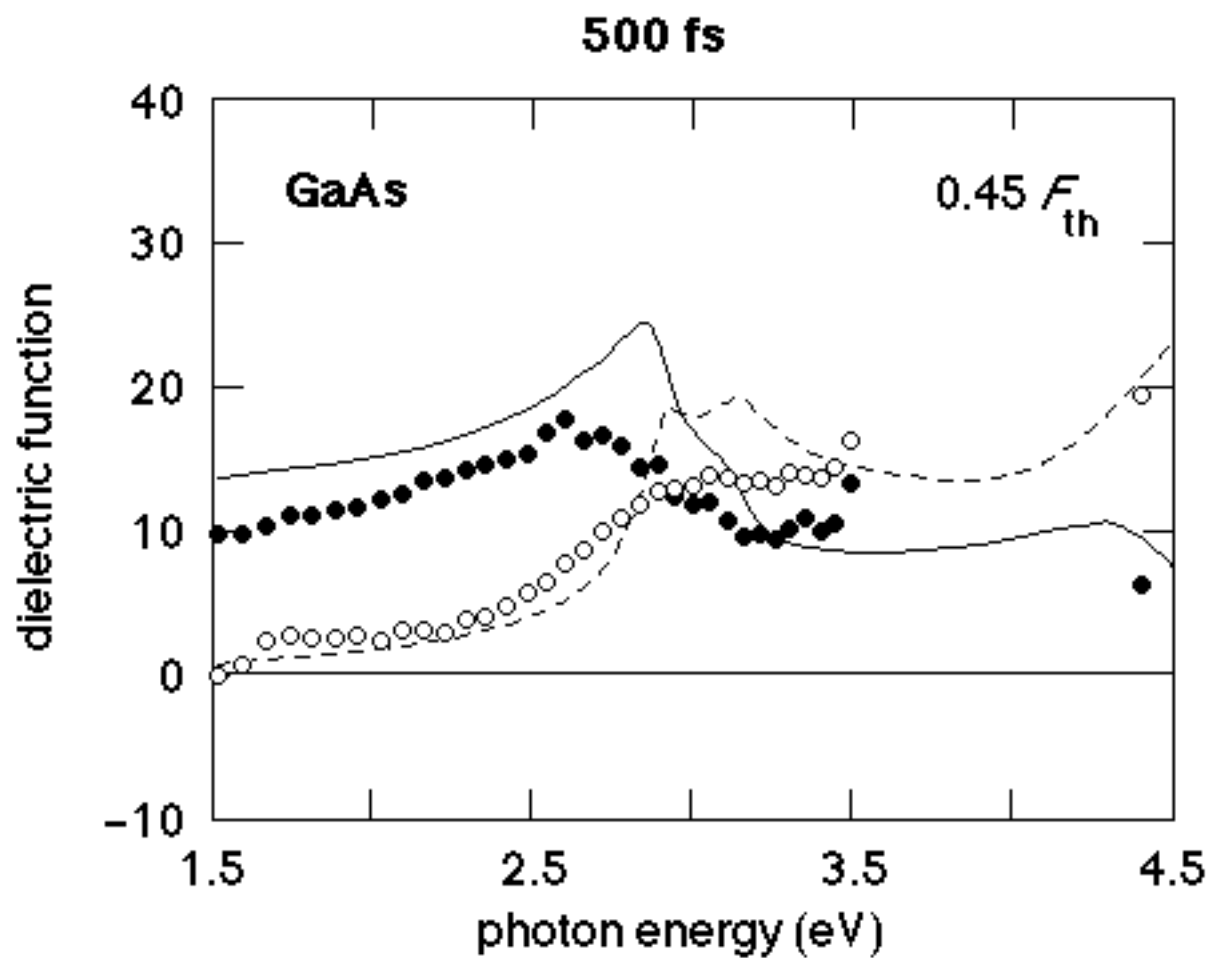

LOW FLUENCE DATA

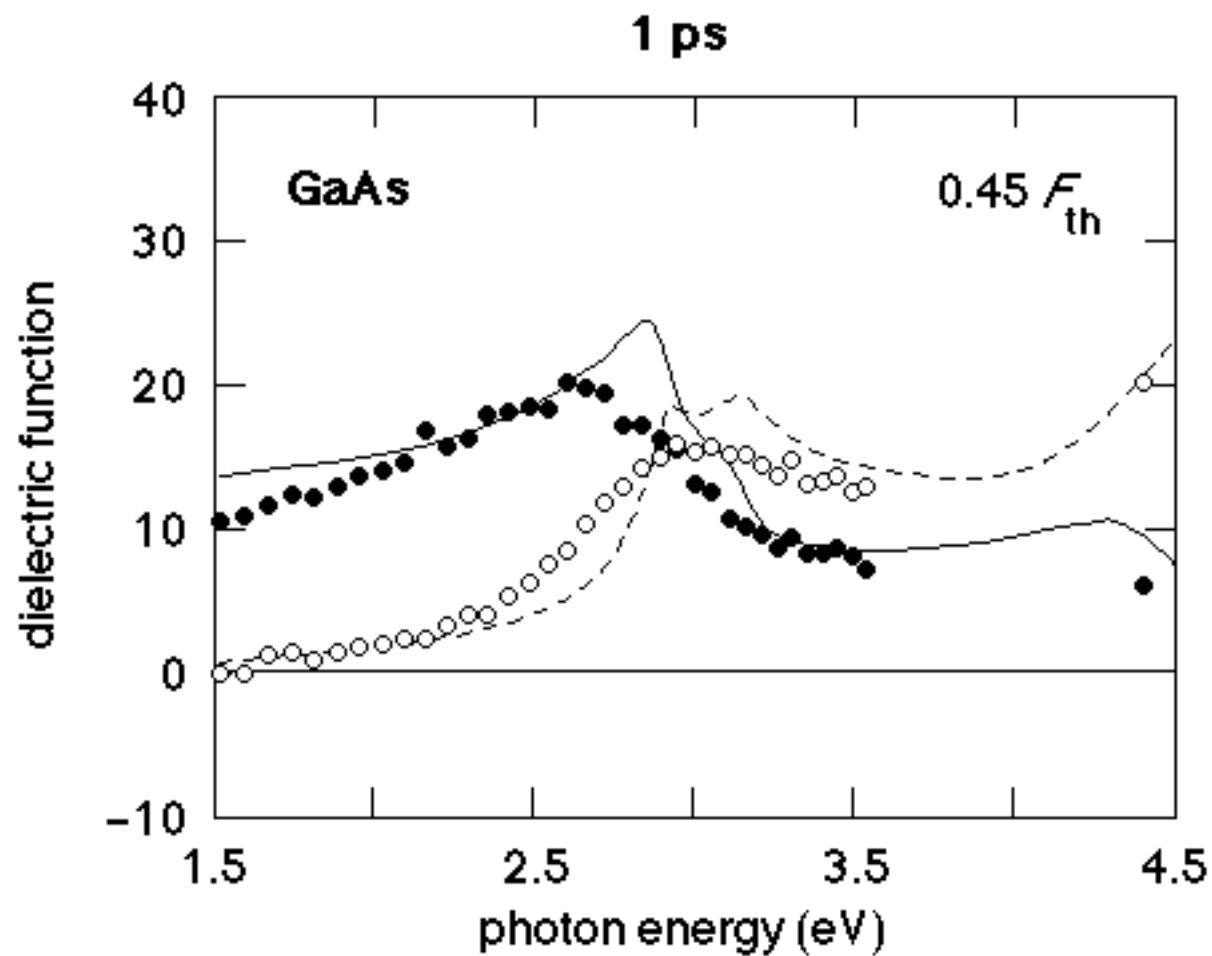

LOW FLUENCE DATA

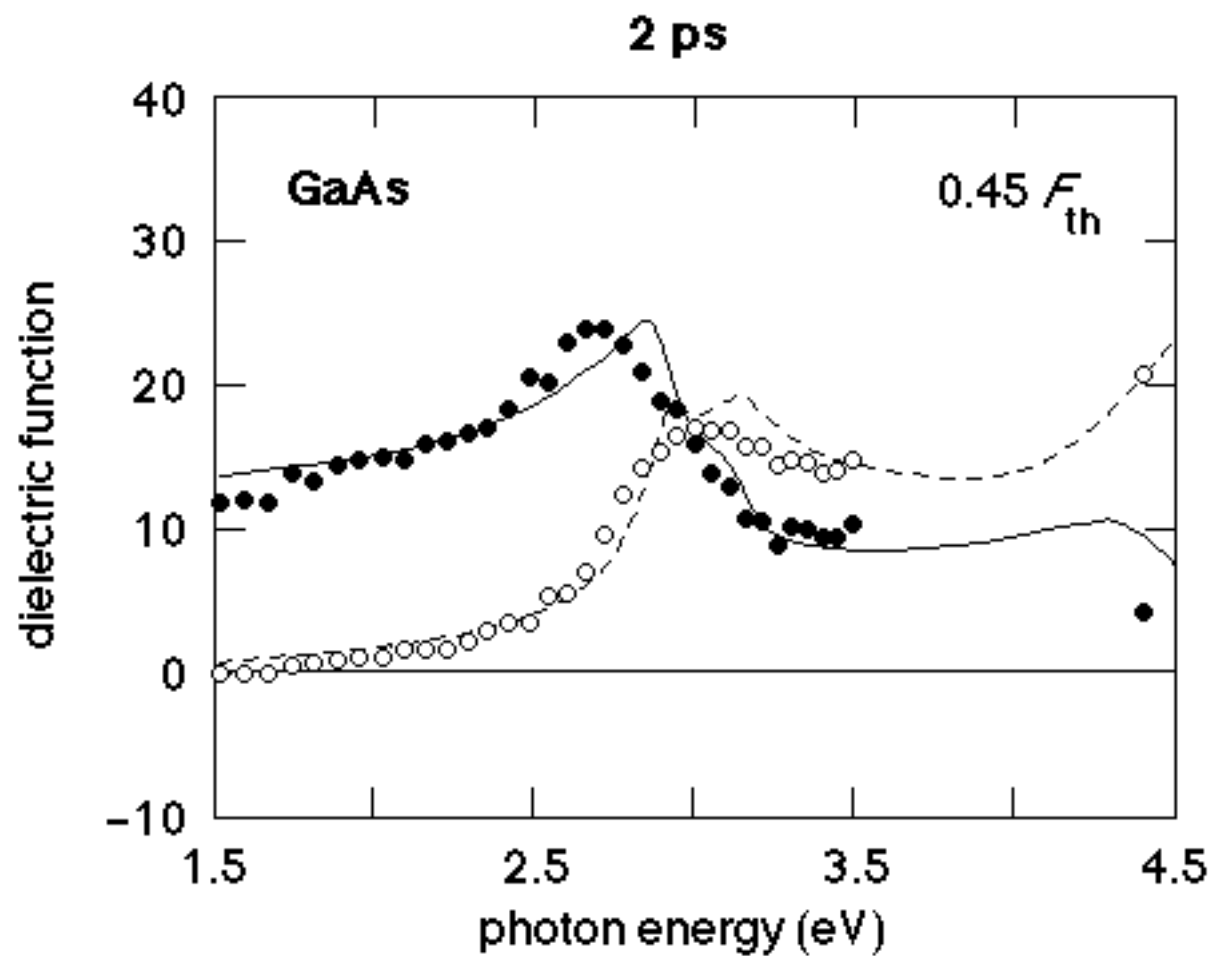

LOW FLUENCE DATA

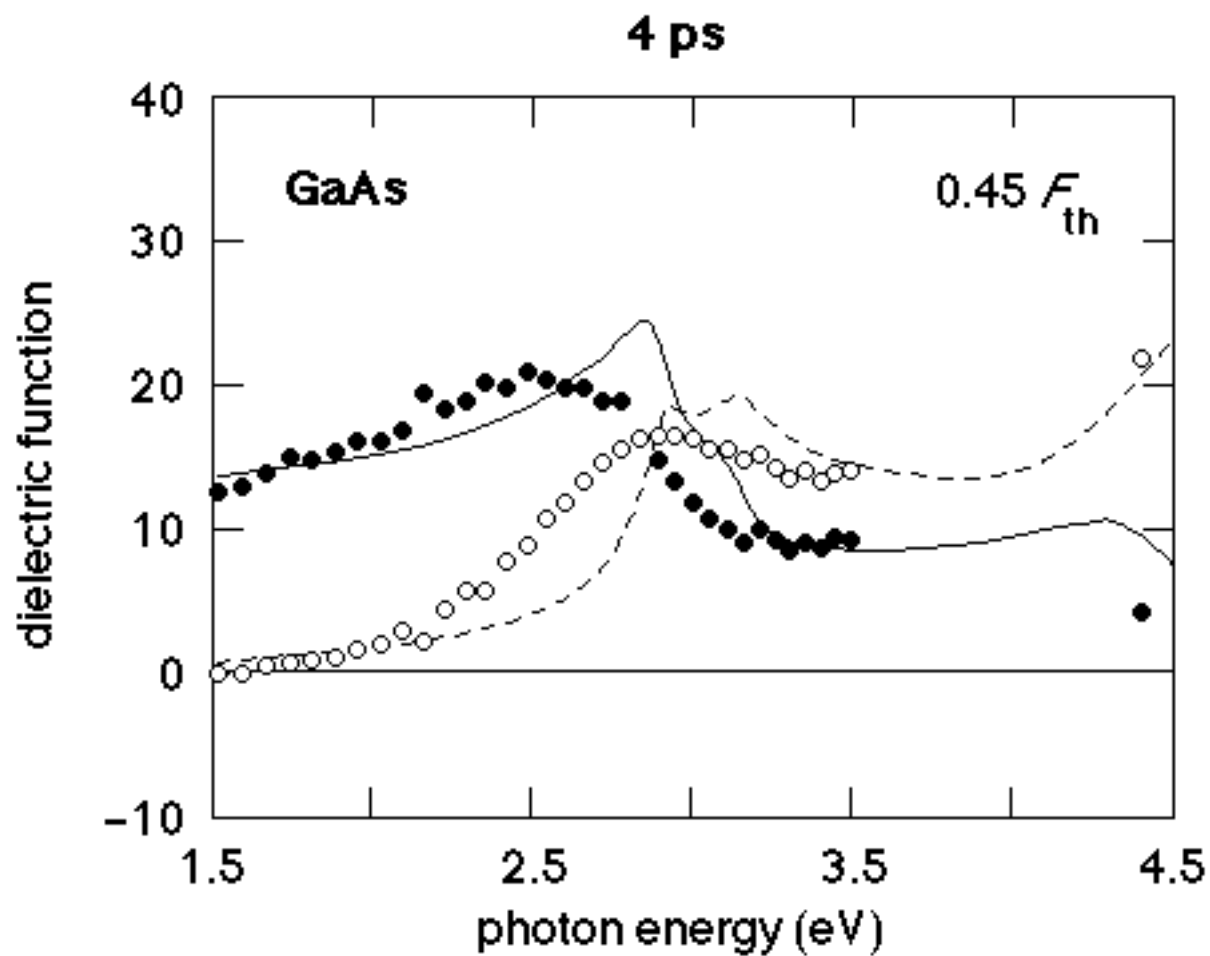

LOW FLUENCE DATA

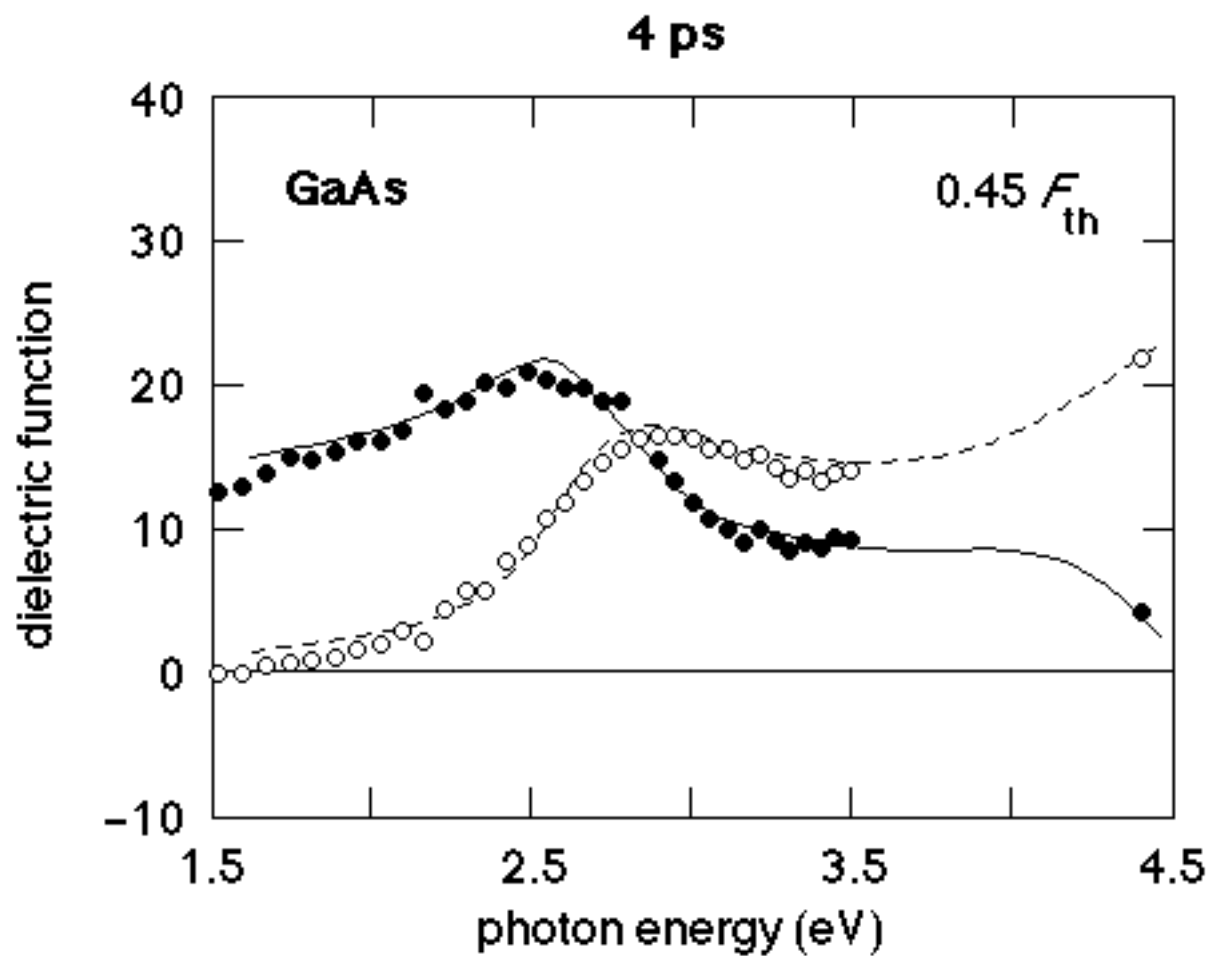

LOW FLUENCE DATA

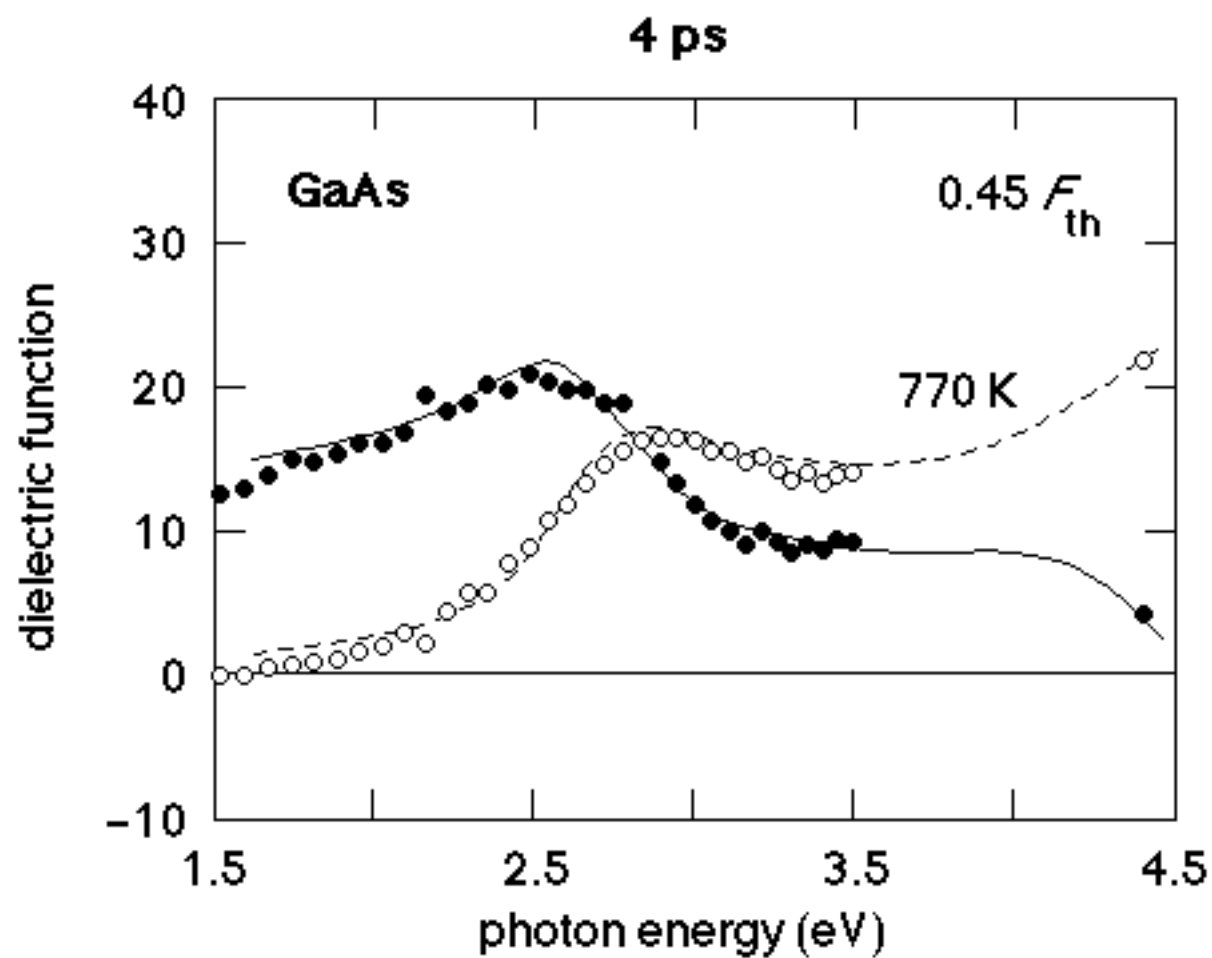

TEMPERATURE

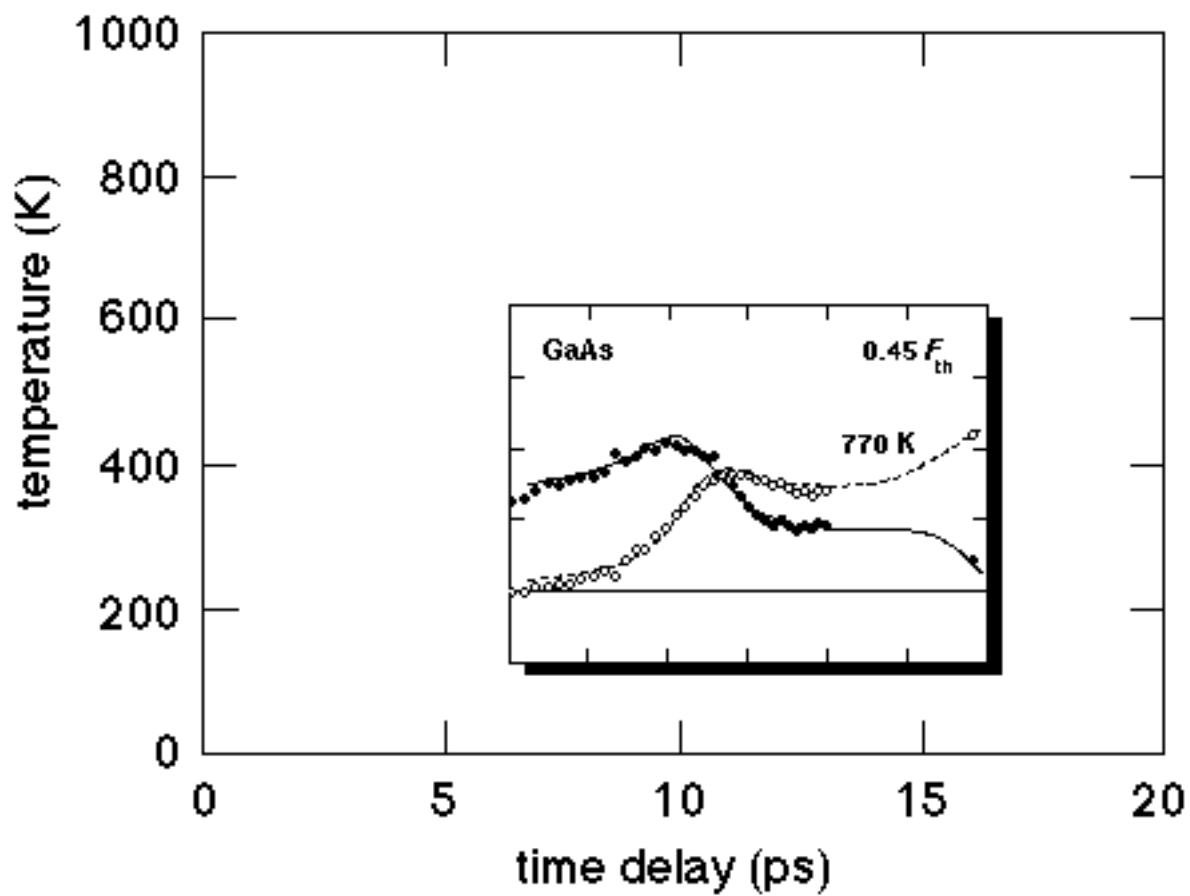

TEMPERATURE

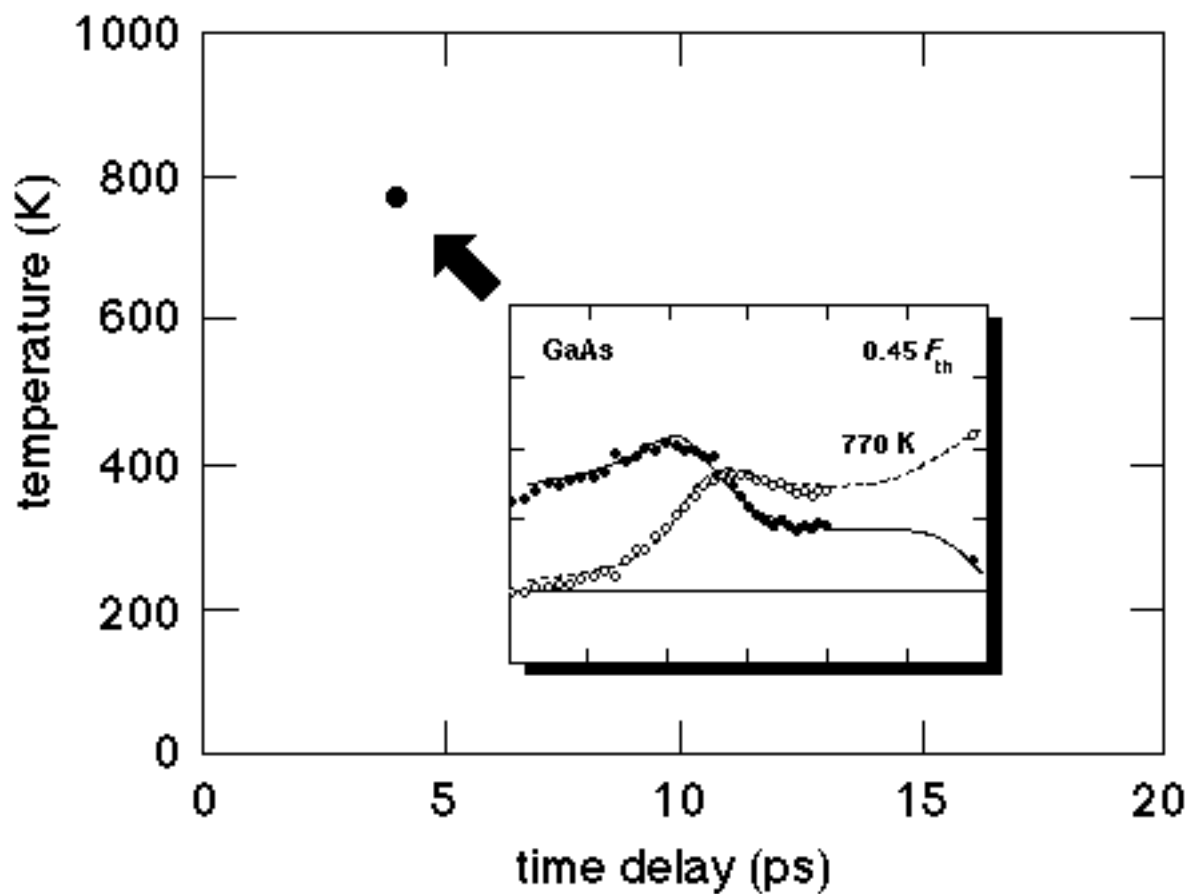

TEMPERATURE

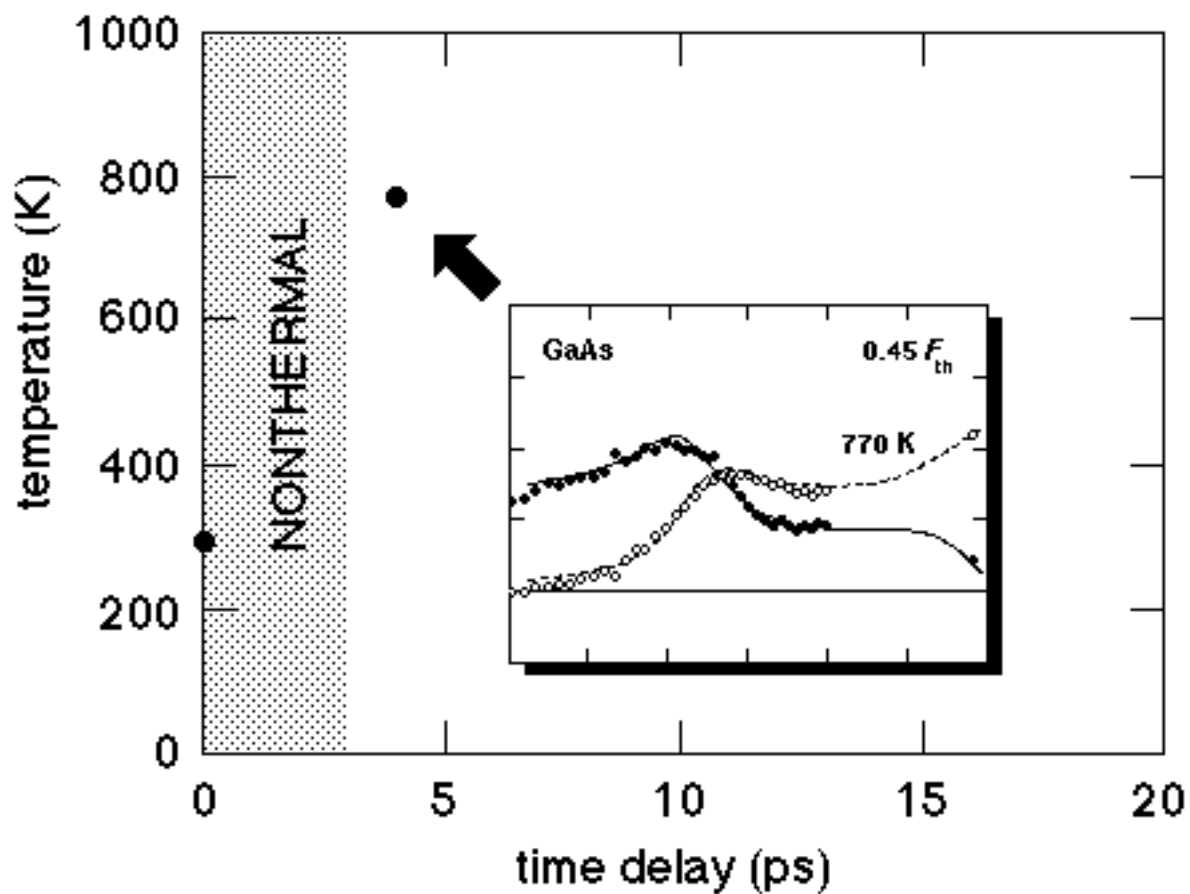

TEMPERATURE

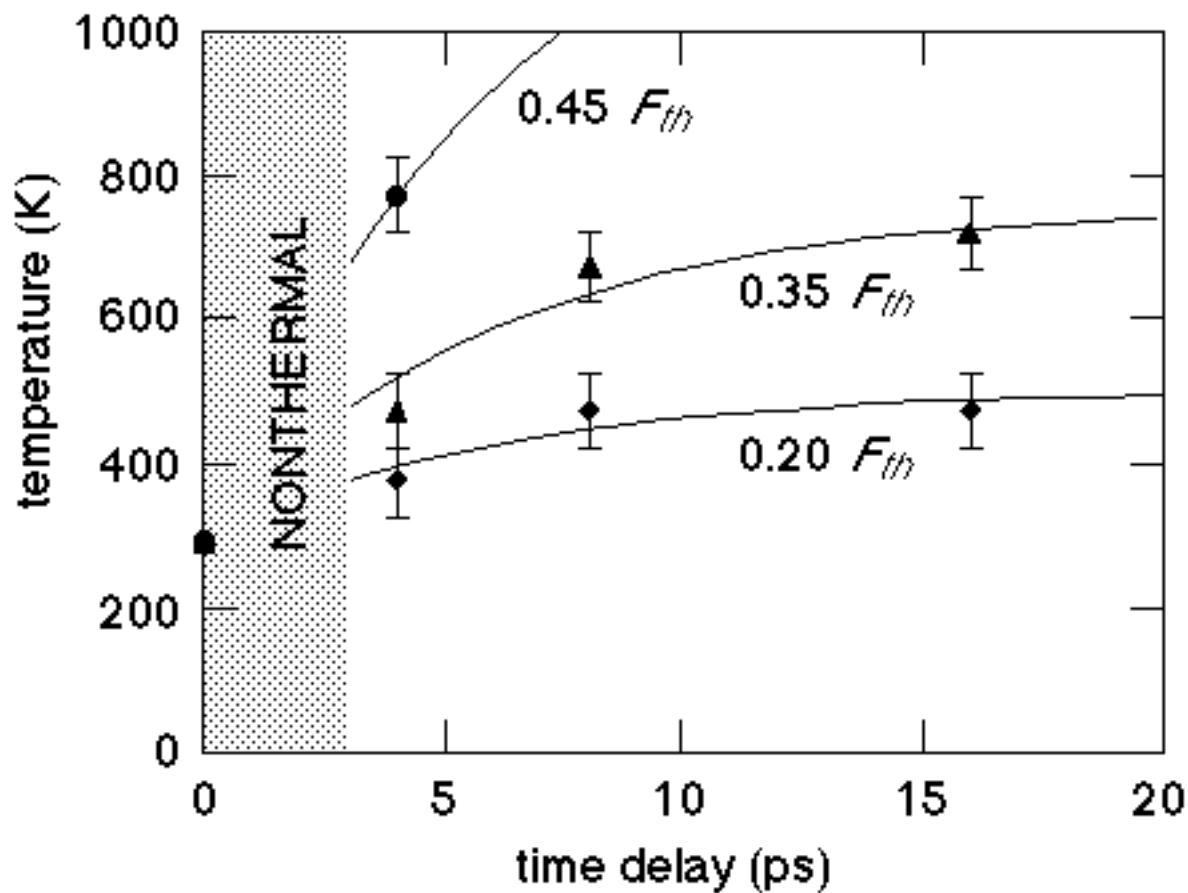

MEDIUM FLUENCE DATA

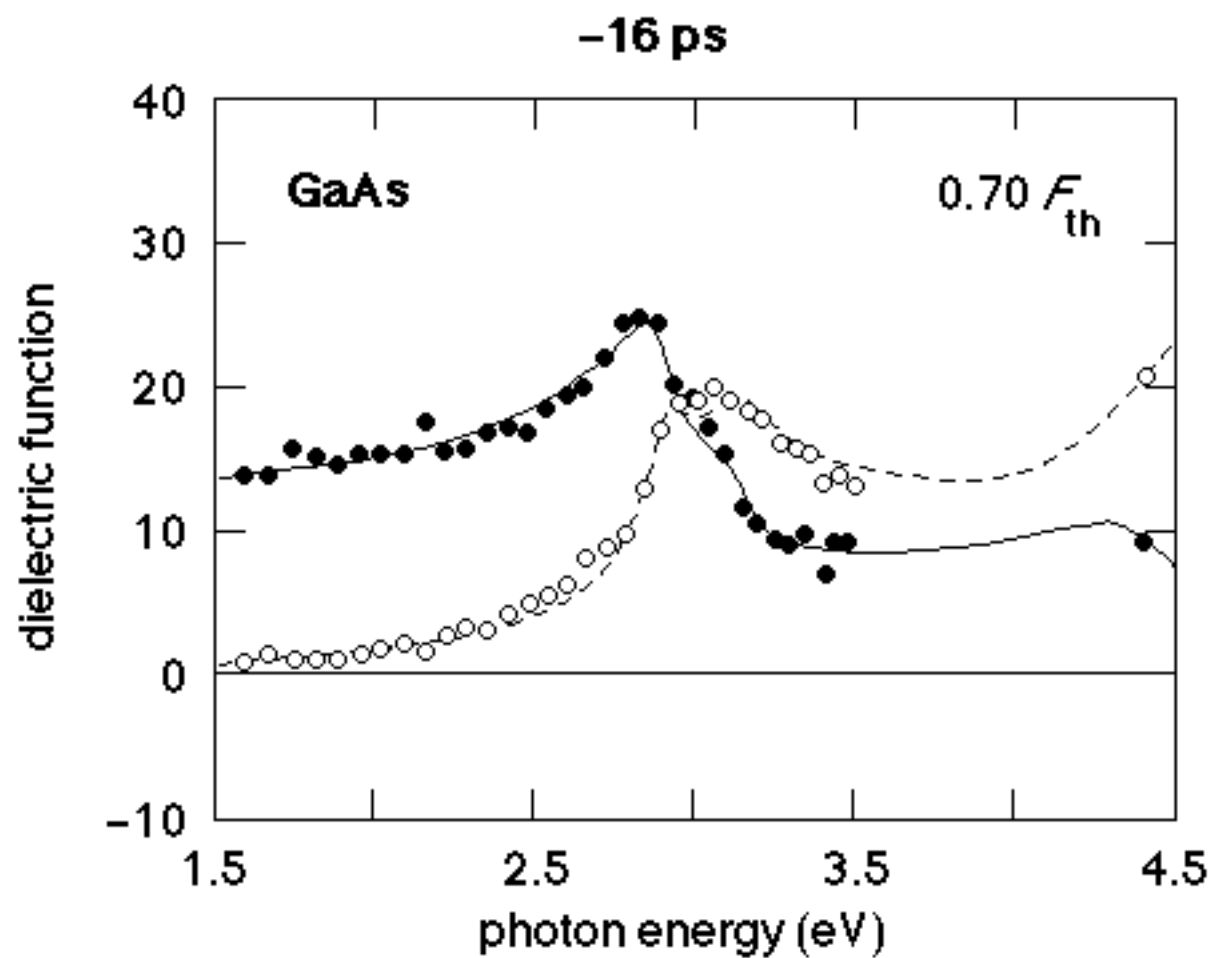

MEDIUM FLUENCE DATA

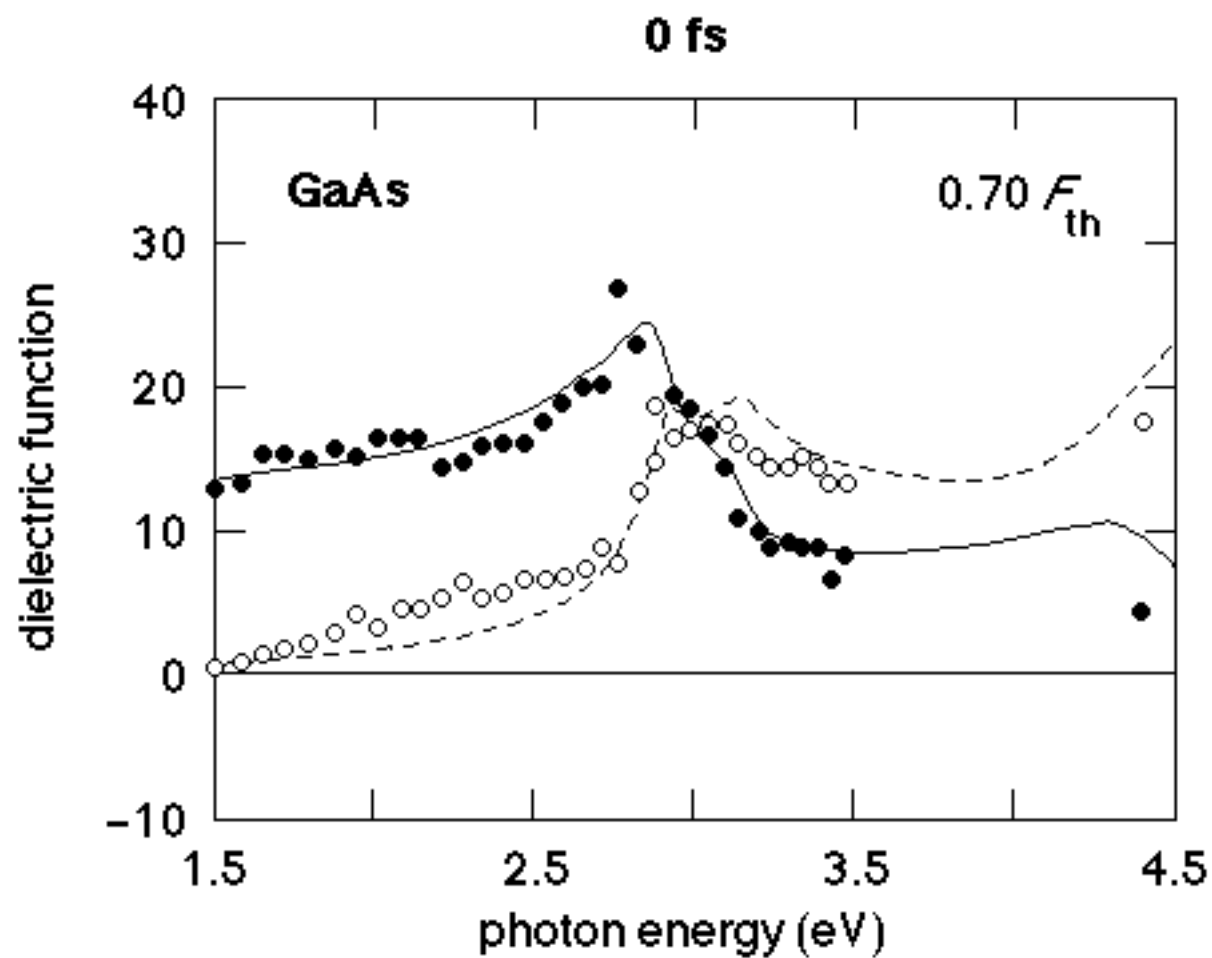

MEDIUM FLUENCE DATA

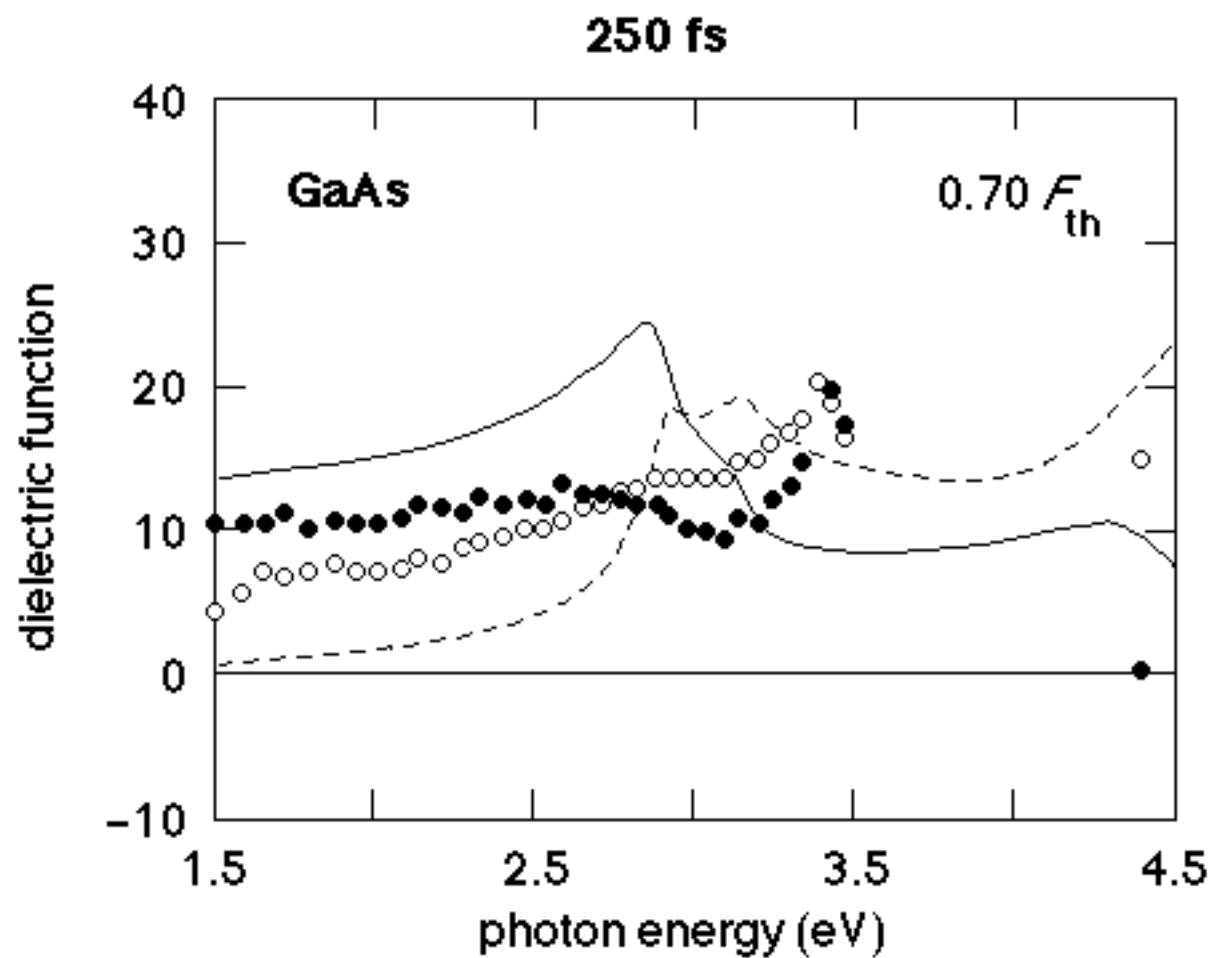

MEDIUM FLUENCE DATA

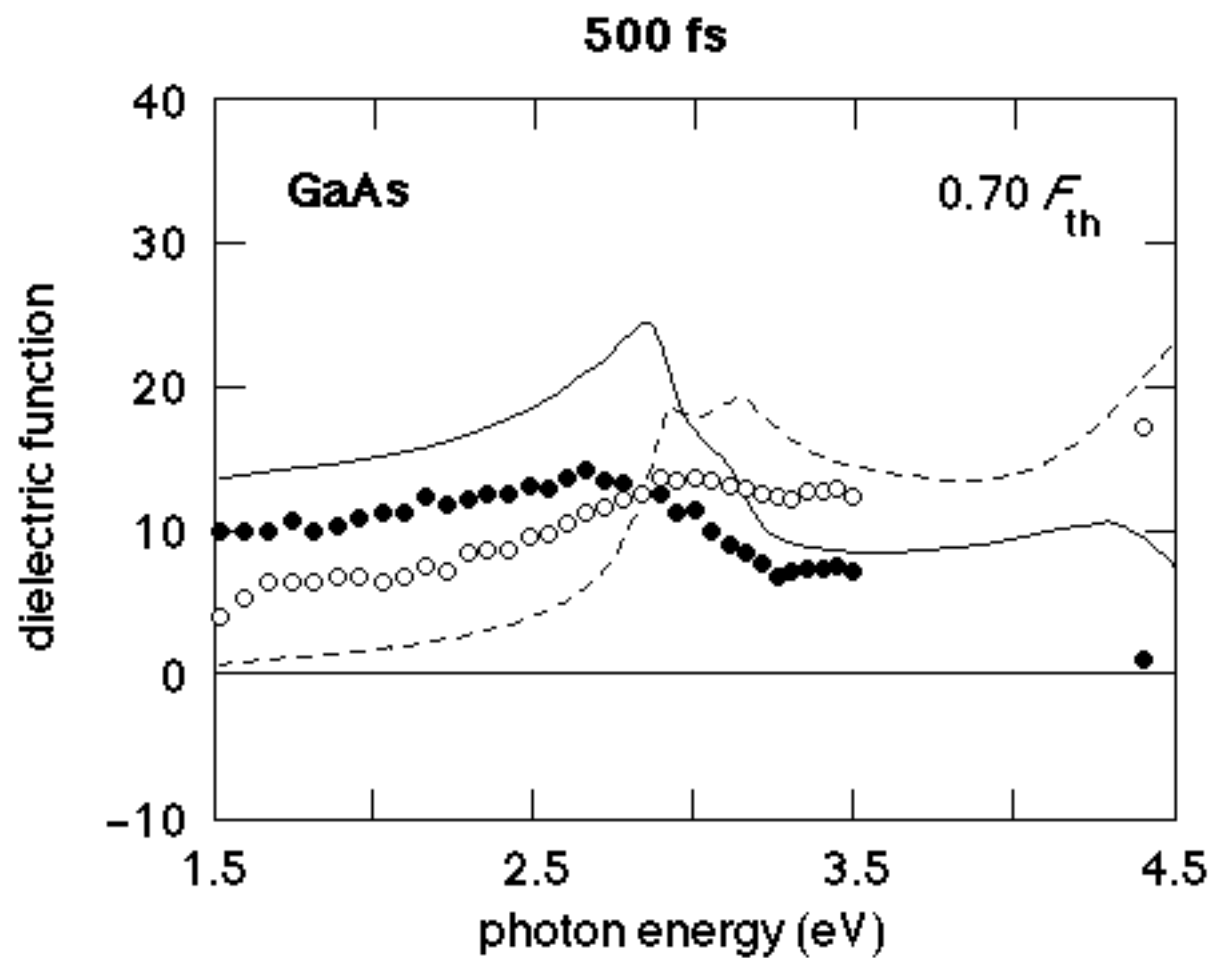

MEDIUM FLUENCE DATA

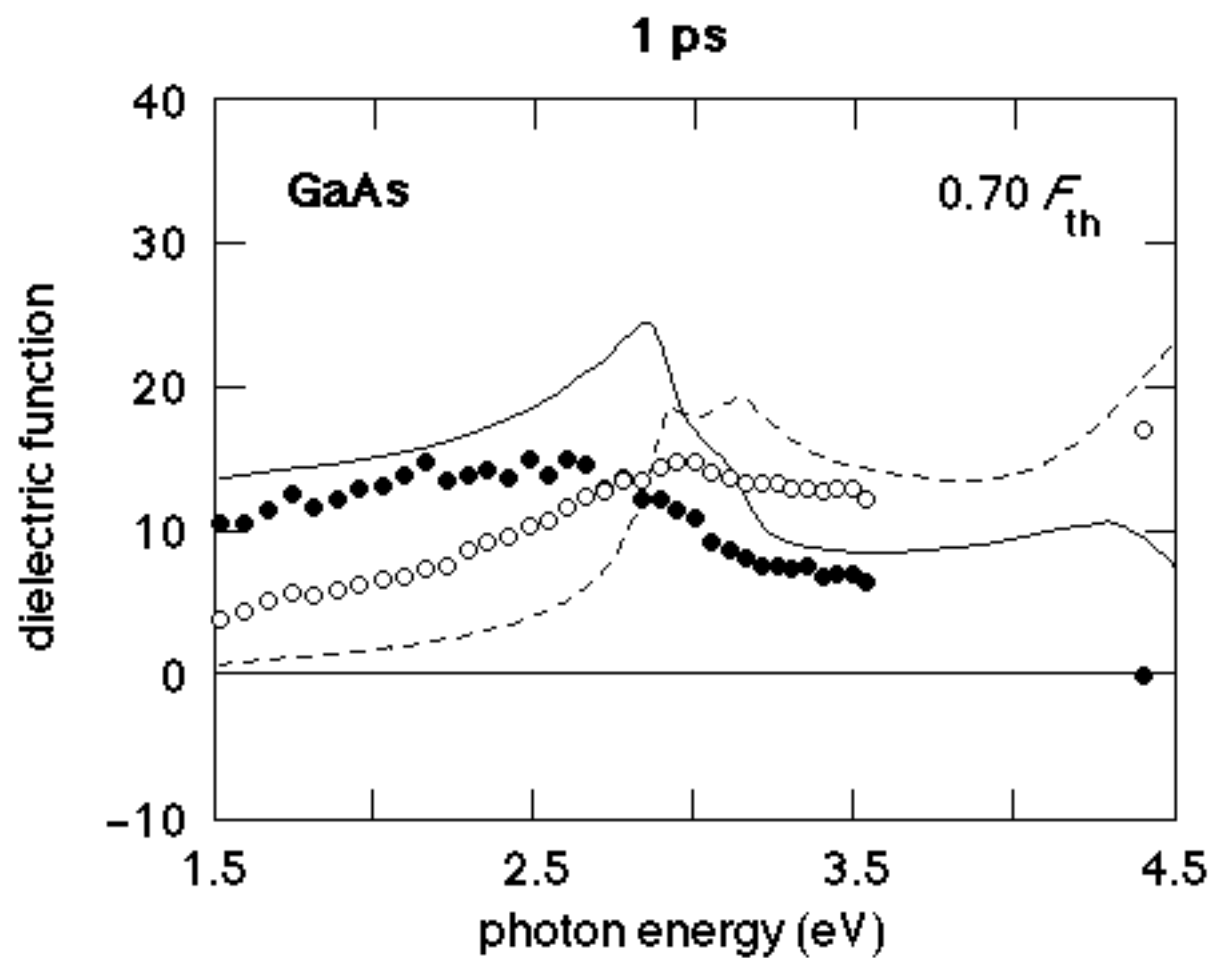

MEDIUM FLUENCE DATA

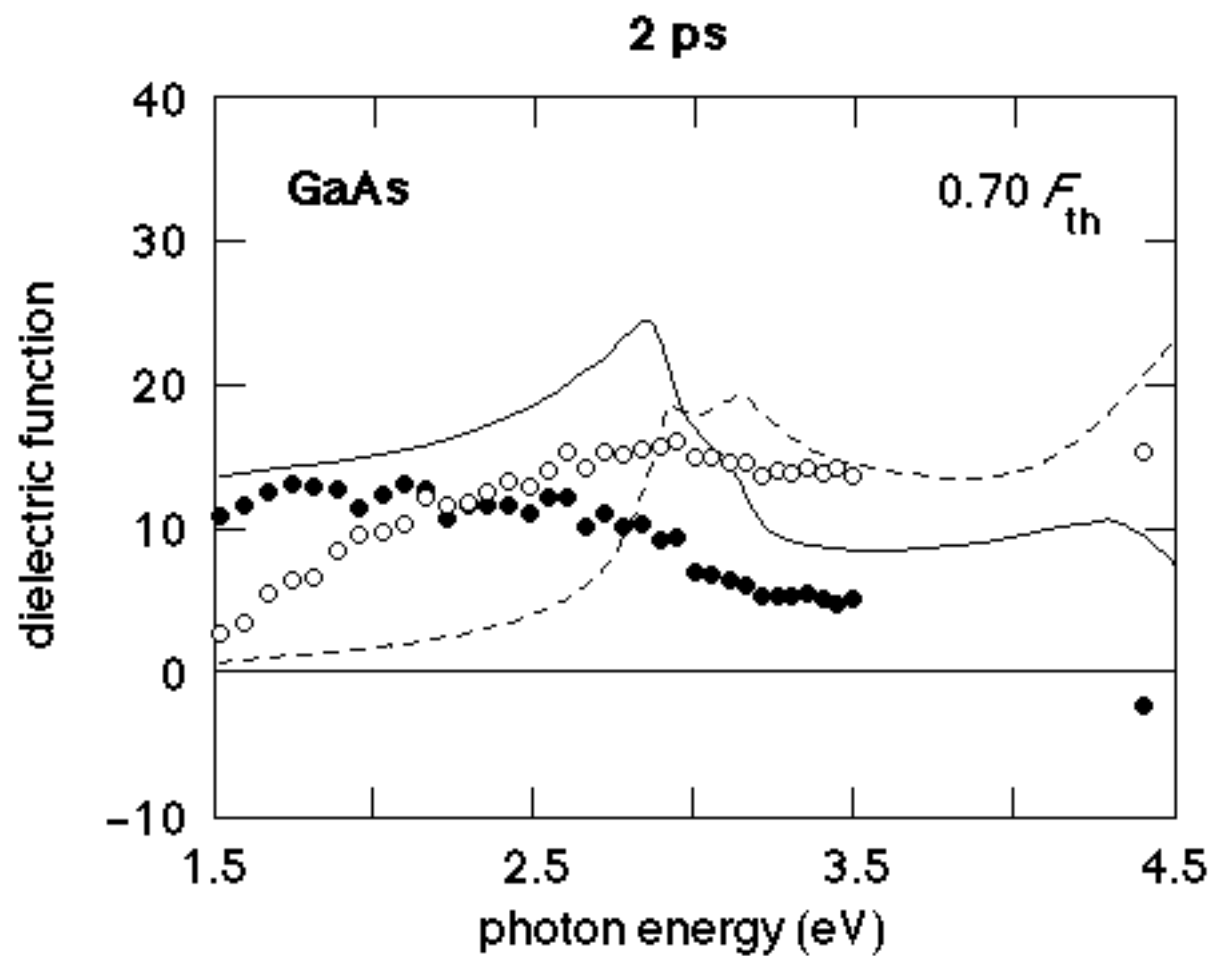

MEDIUM FLUENCE DATA

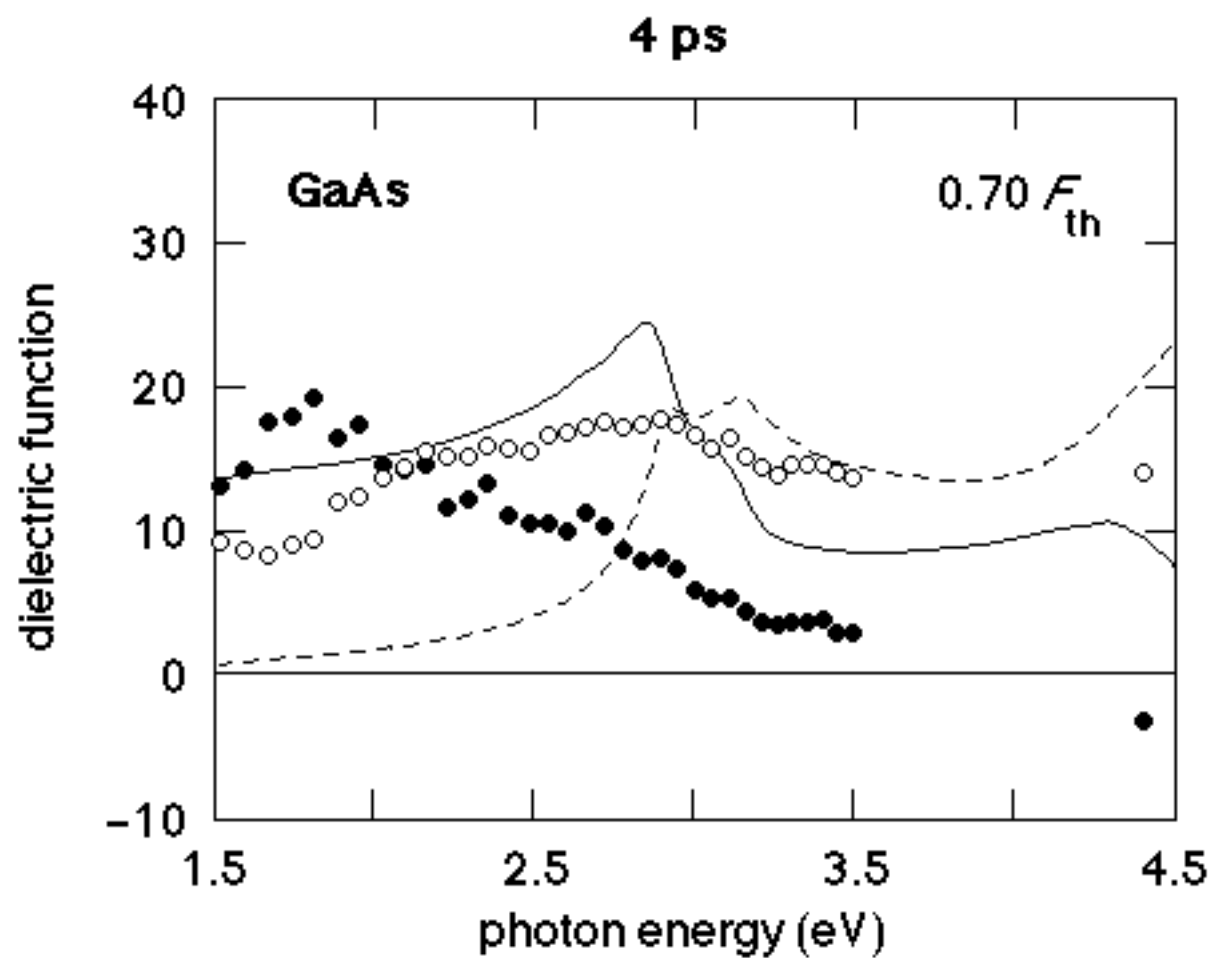

MEDIUM FLUENCE DATA

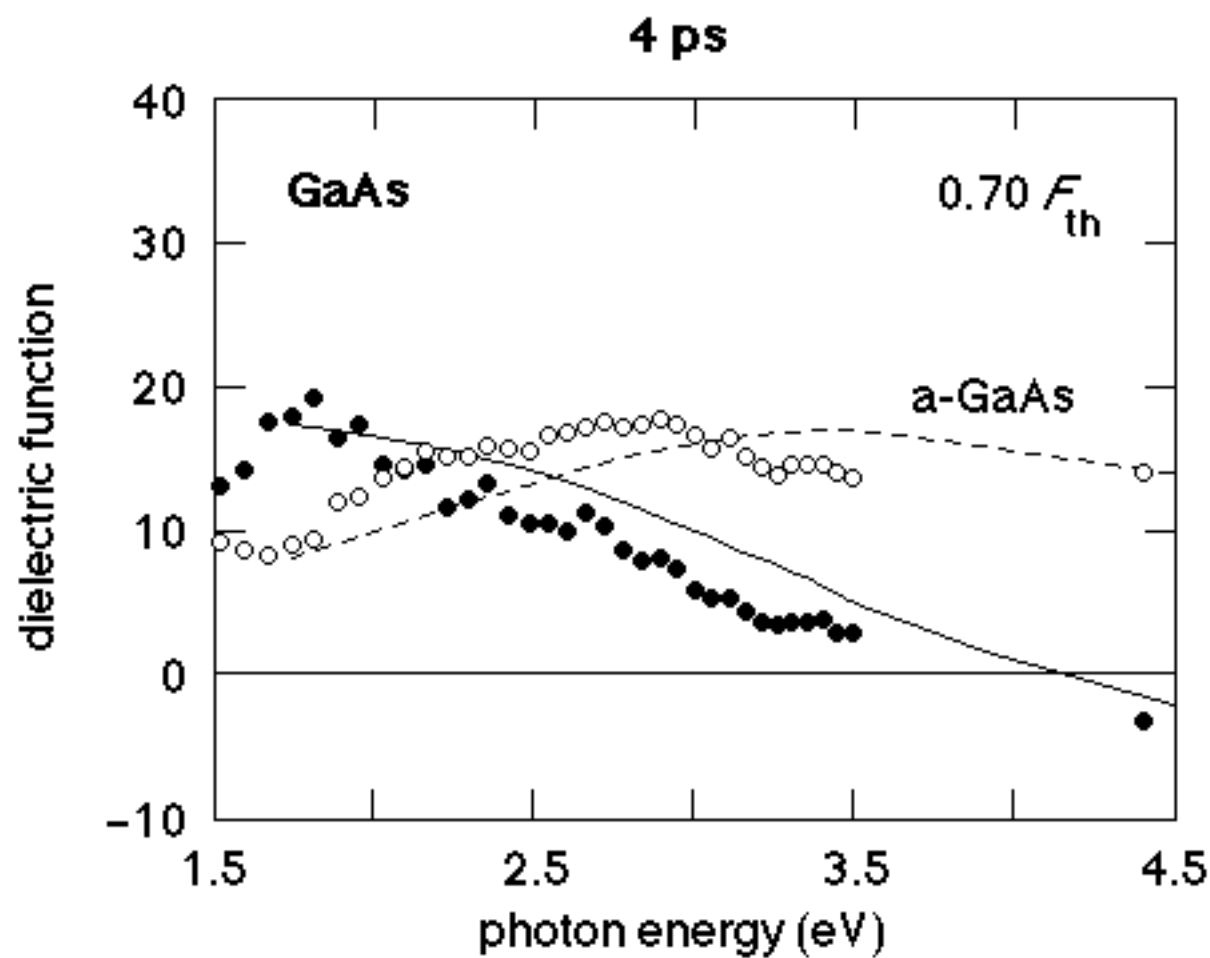

HIGH FLUENCE DATA

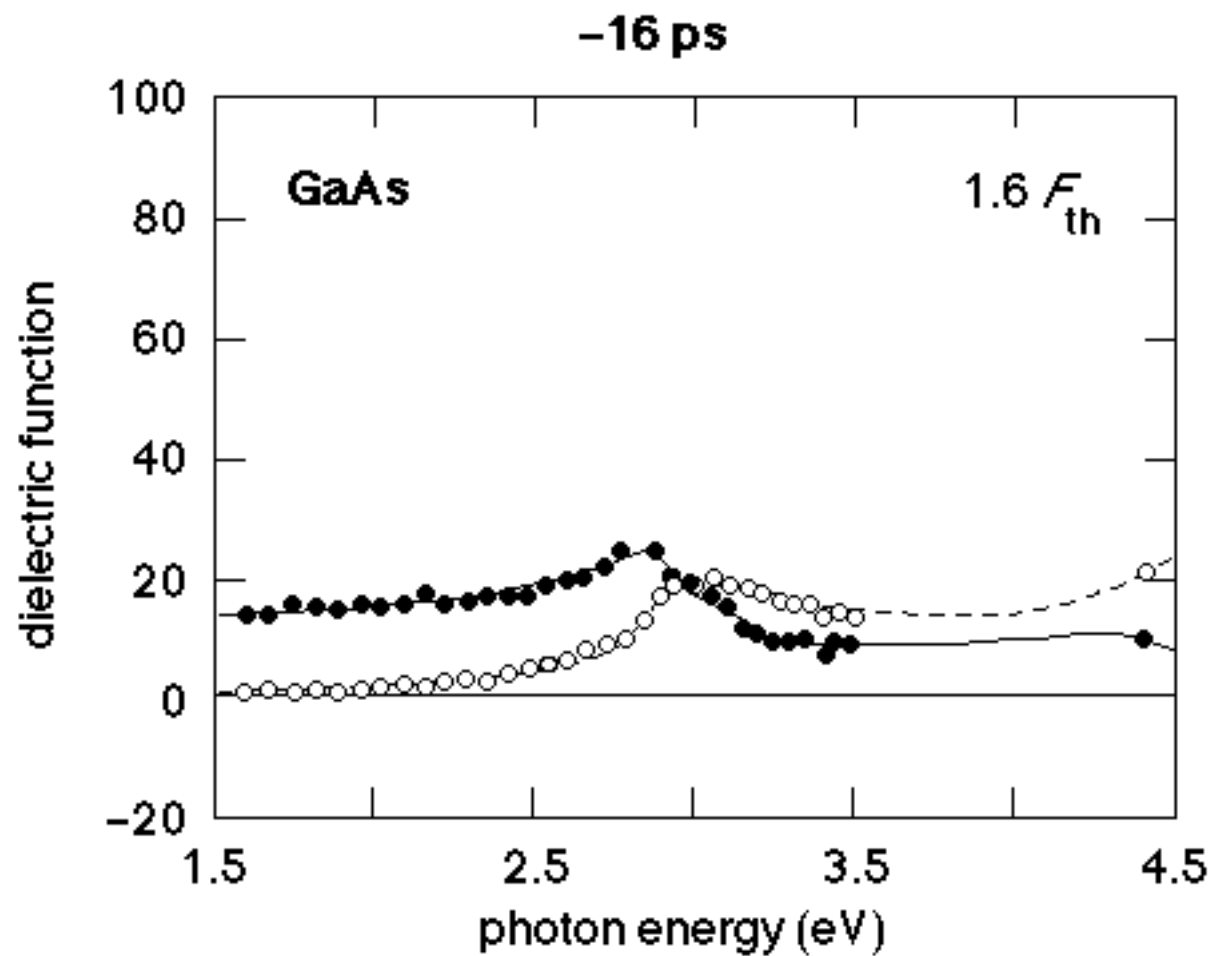

HIGH FLUENCE DATA

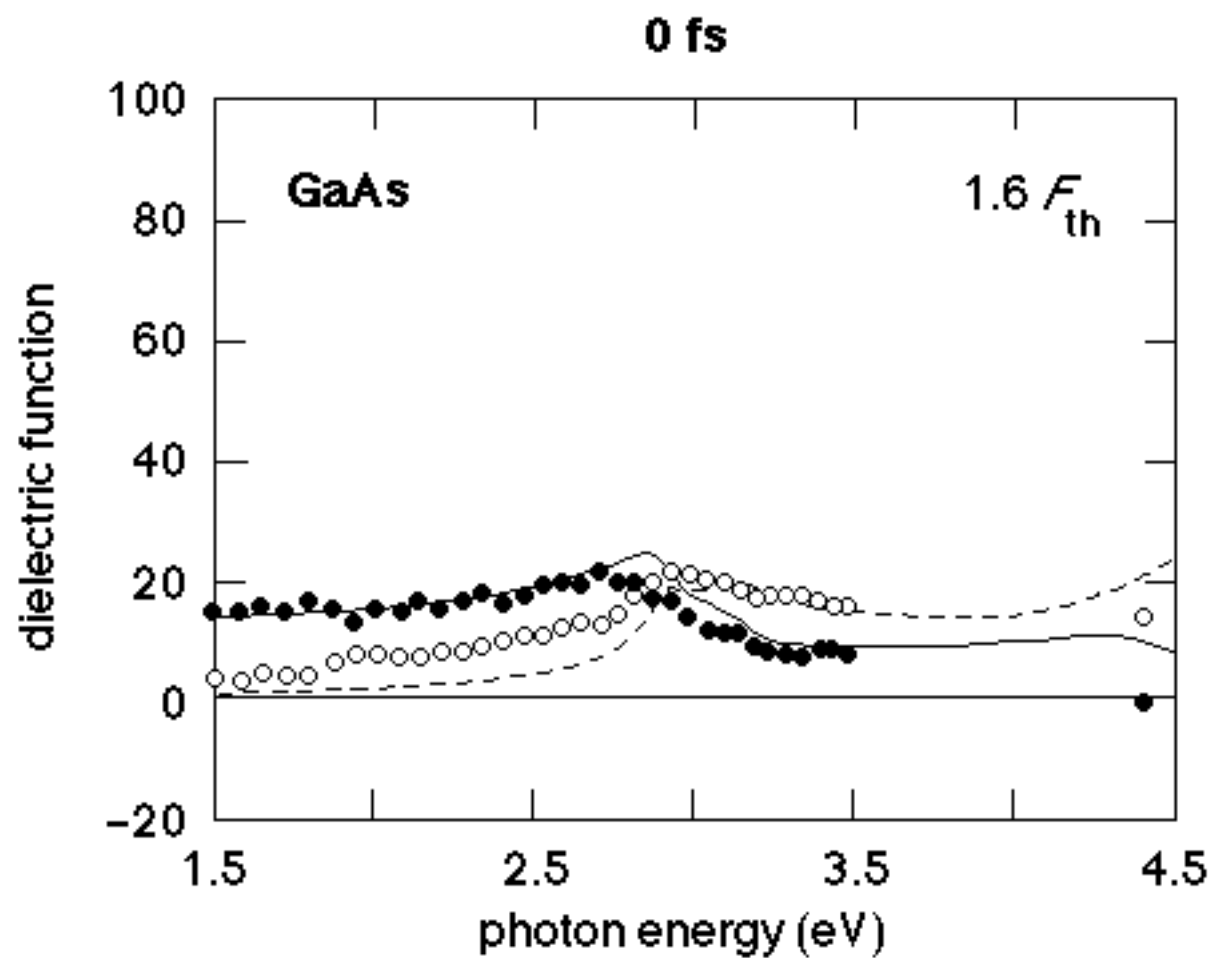

HIGH FLUENCE DATA

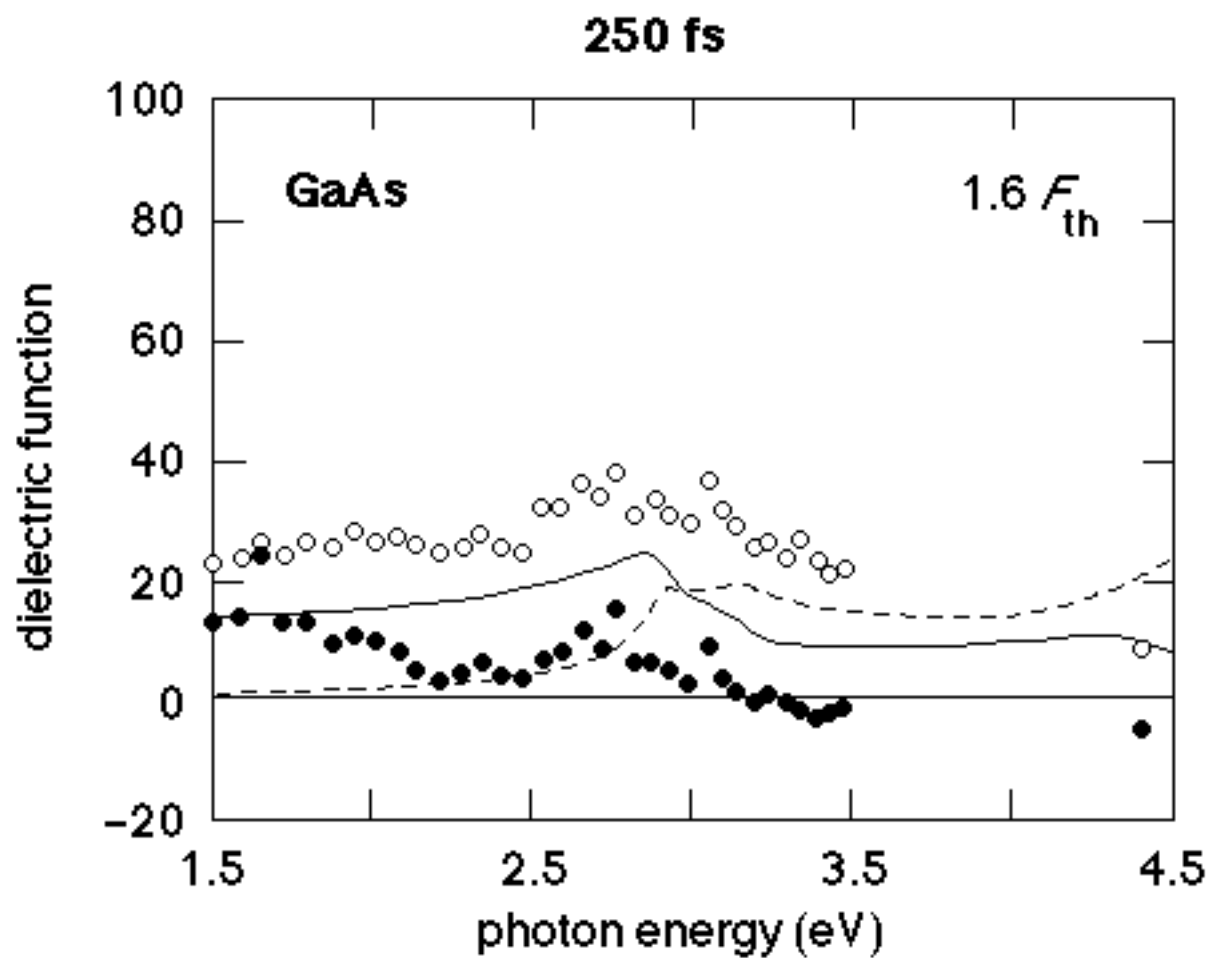

HIGH FLUENCE DATA

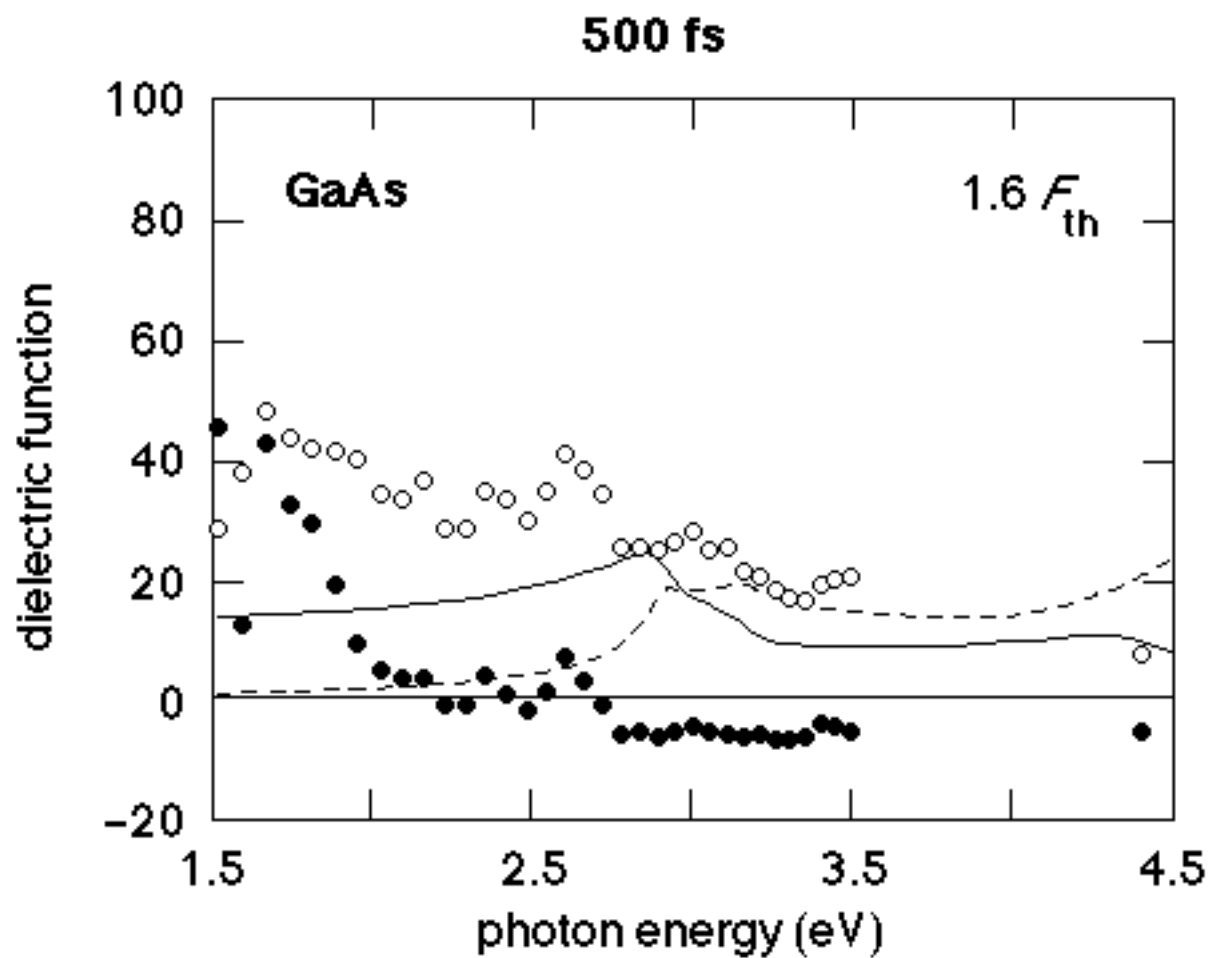

HIGH FLUENCE DATA

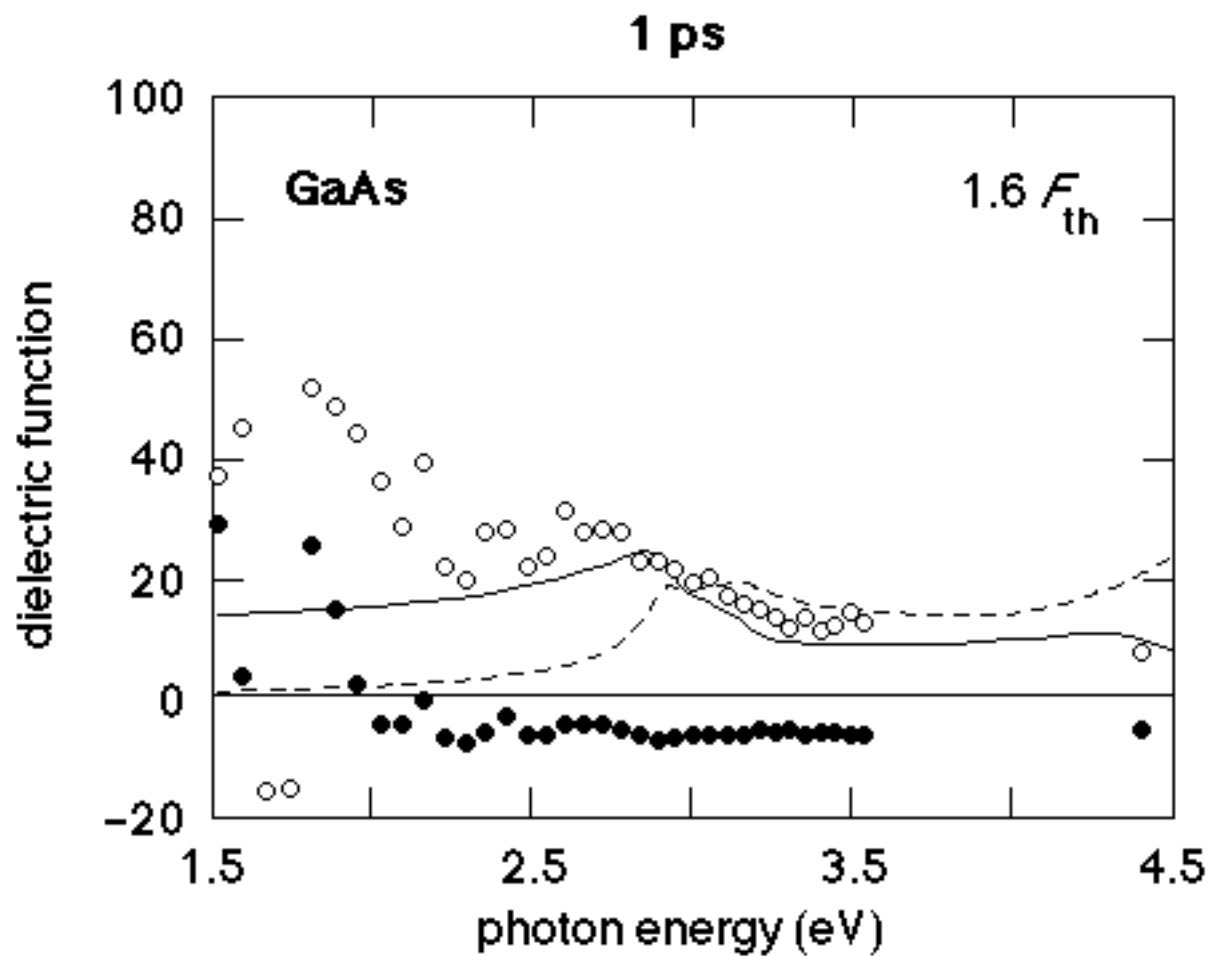

HIGH FLUENCE DATA

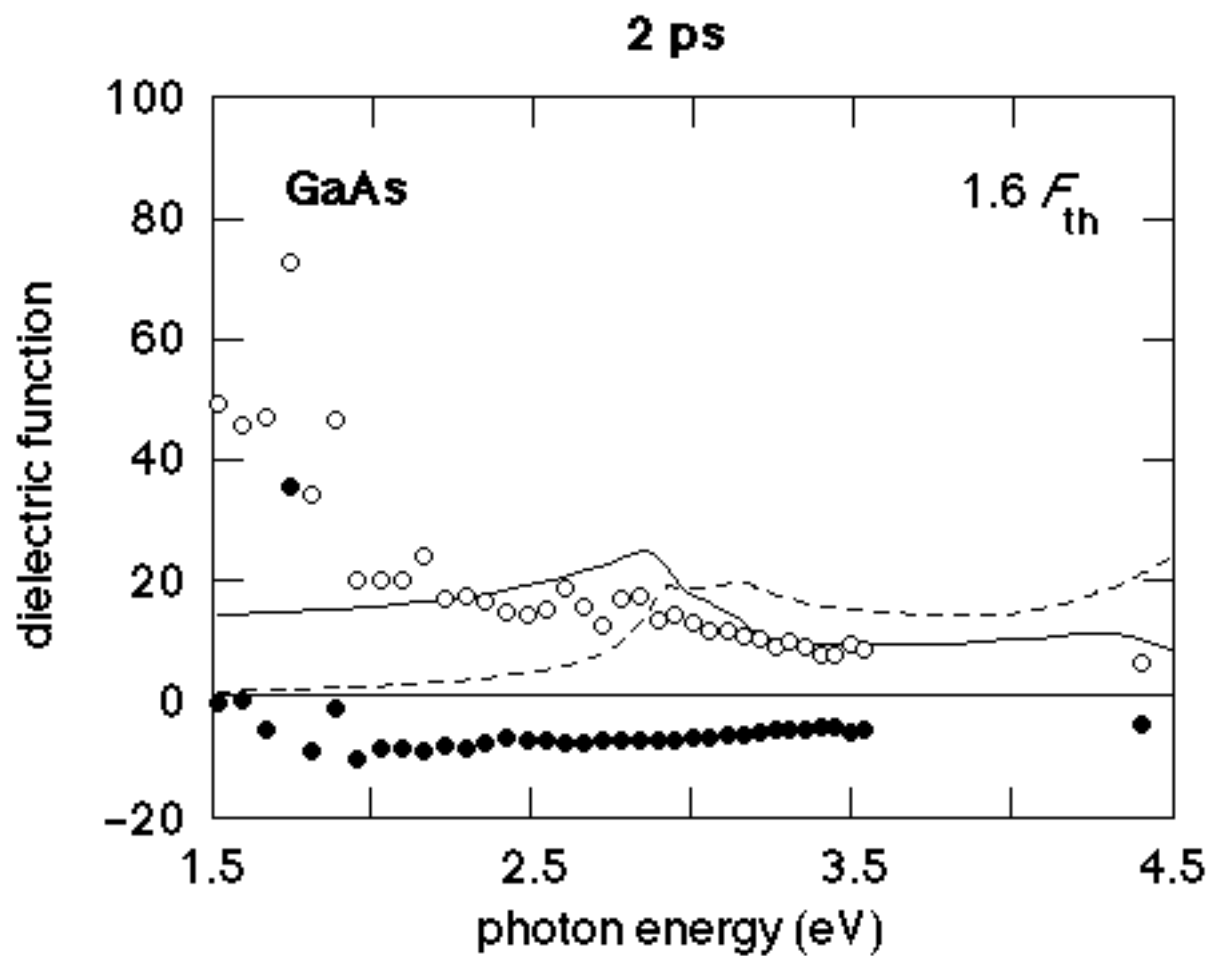

DISCUSSION

structure

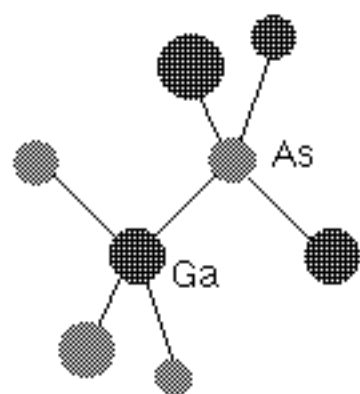

bandstructure

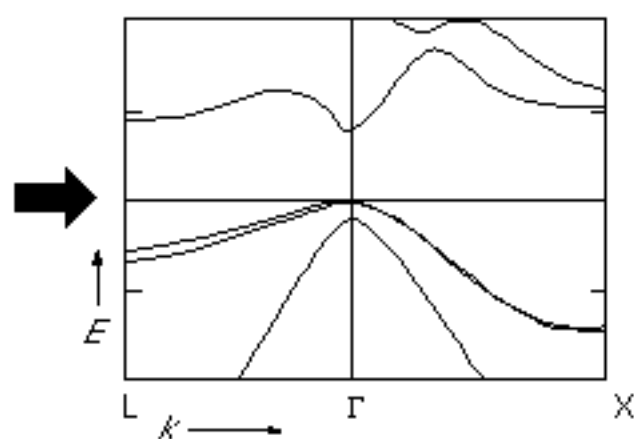

dielectric function

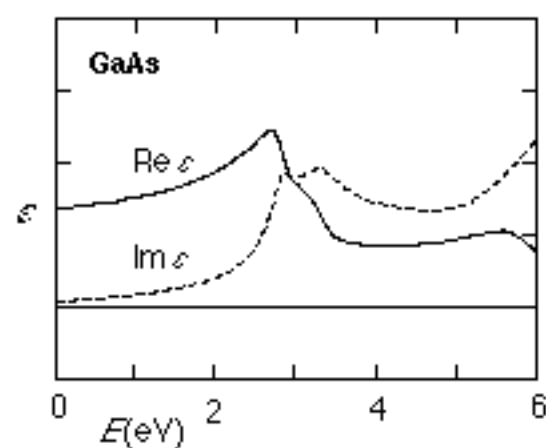

HIGH FLUENCE DATA

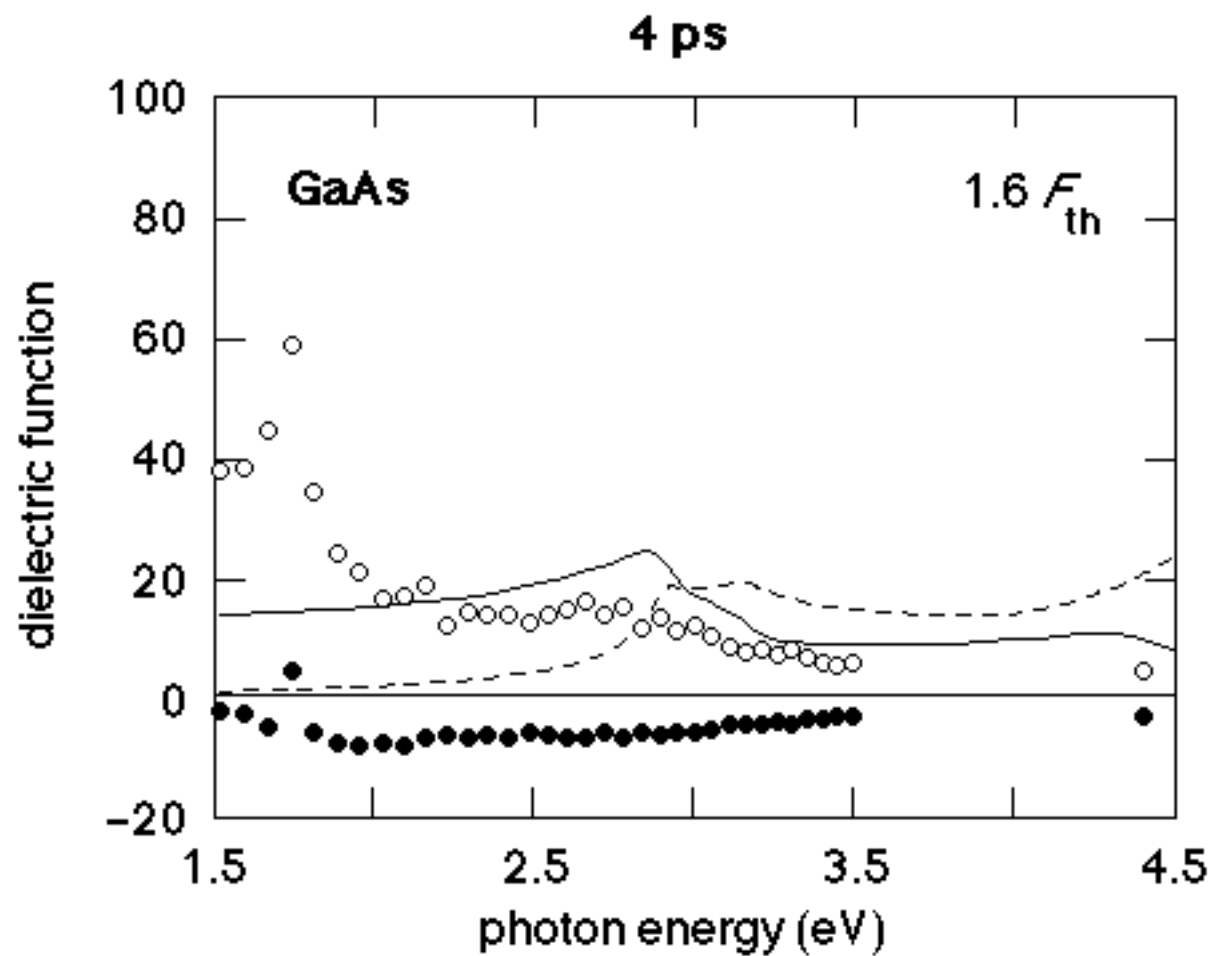

HIGH FLUENCE DATA

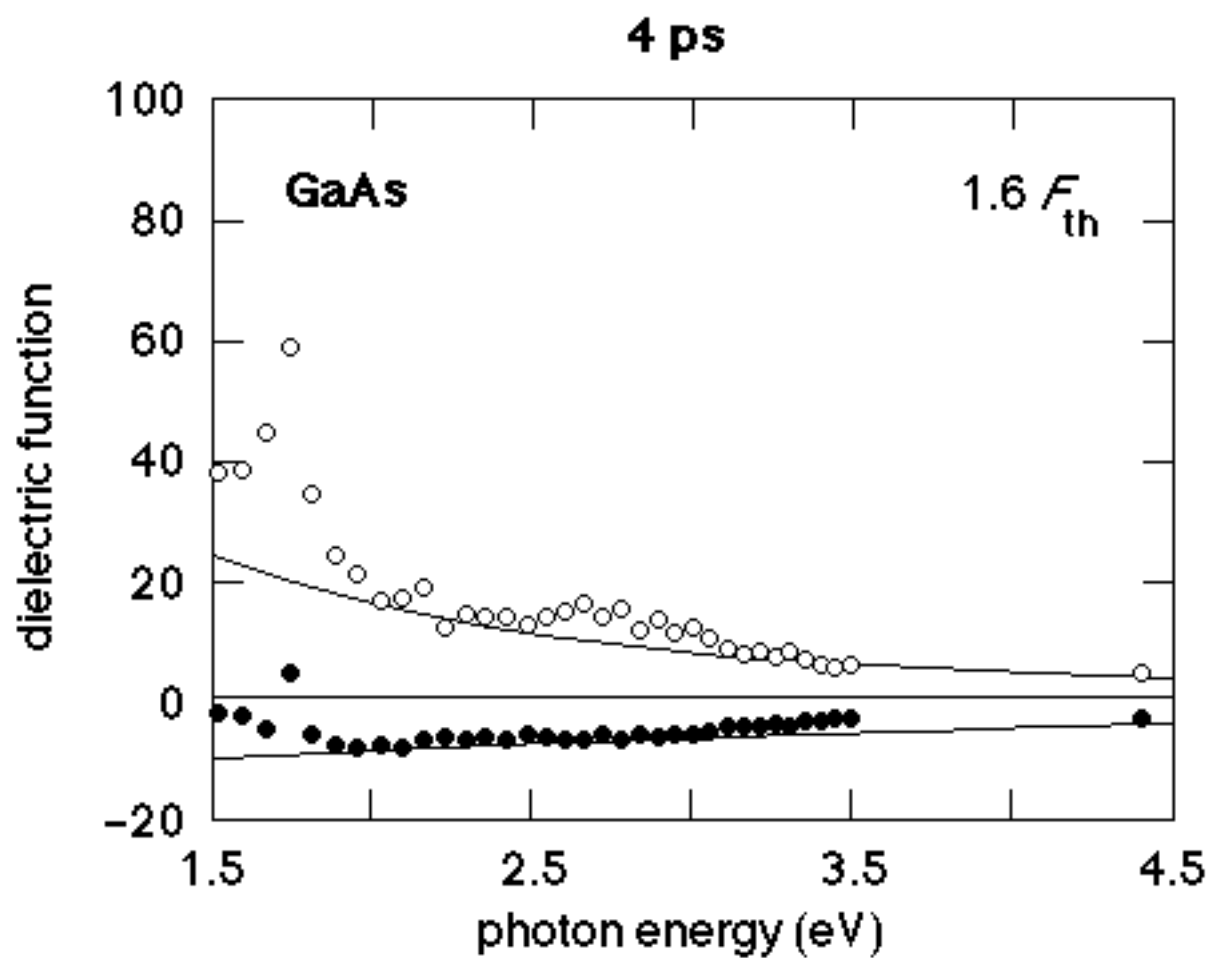

CARRIER DENSITY

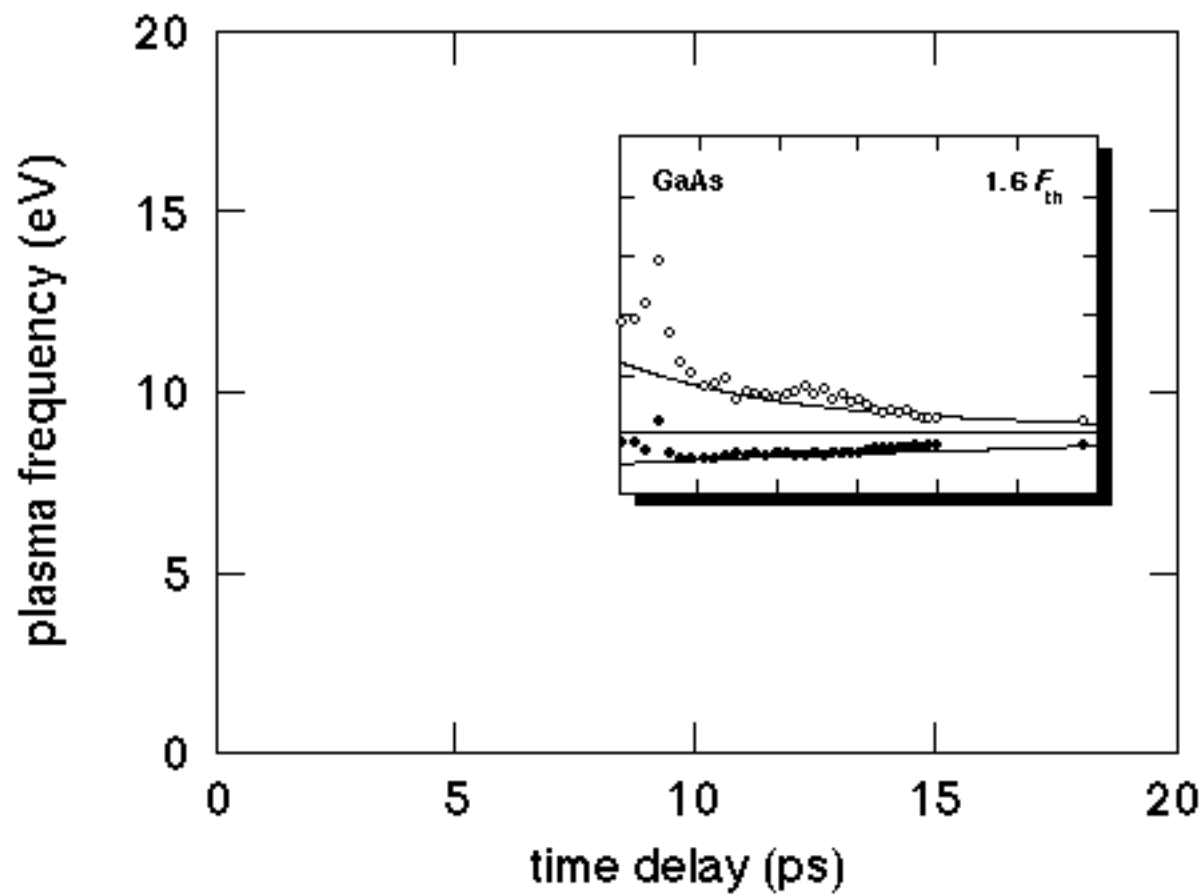

CARRIER DENSITY

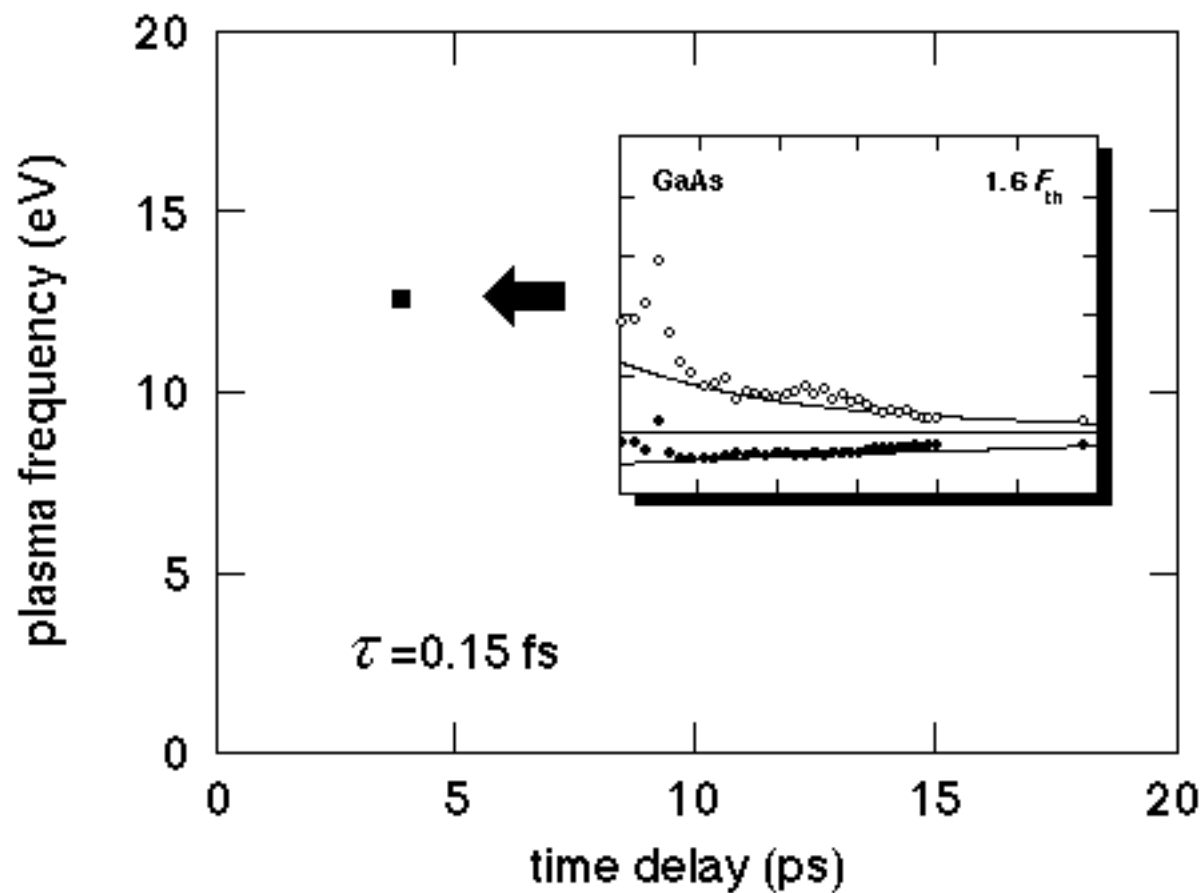

CARRIER DENSITY

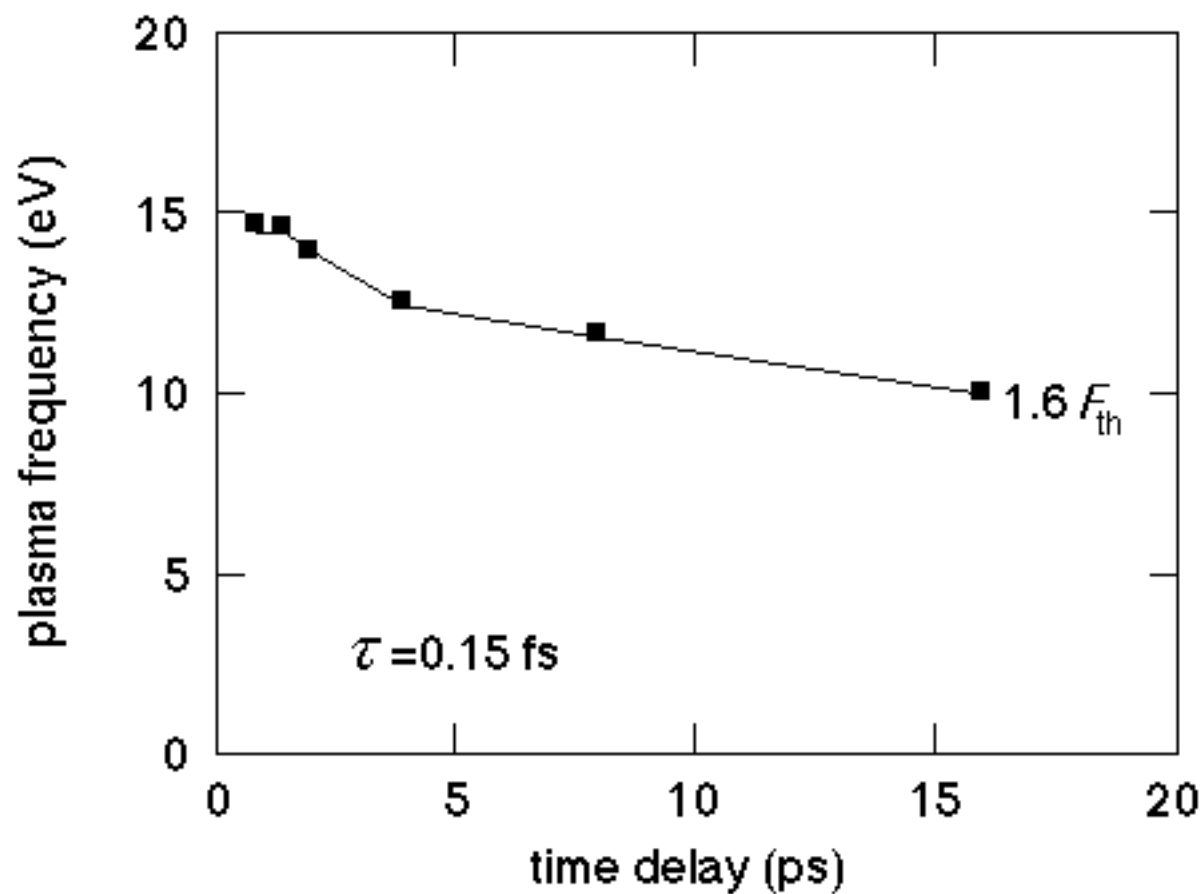

CARRIER DENSITY

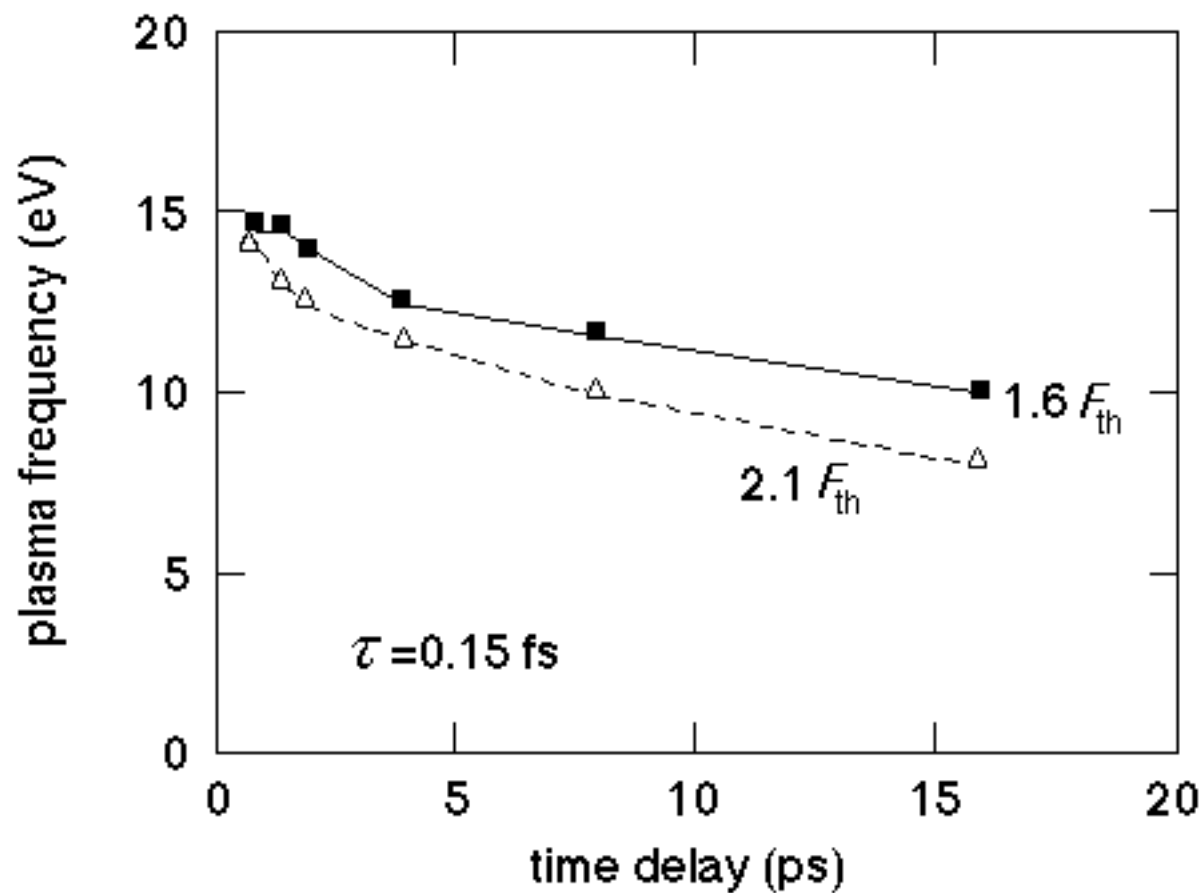

CARRIER DENSITY

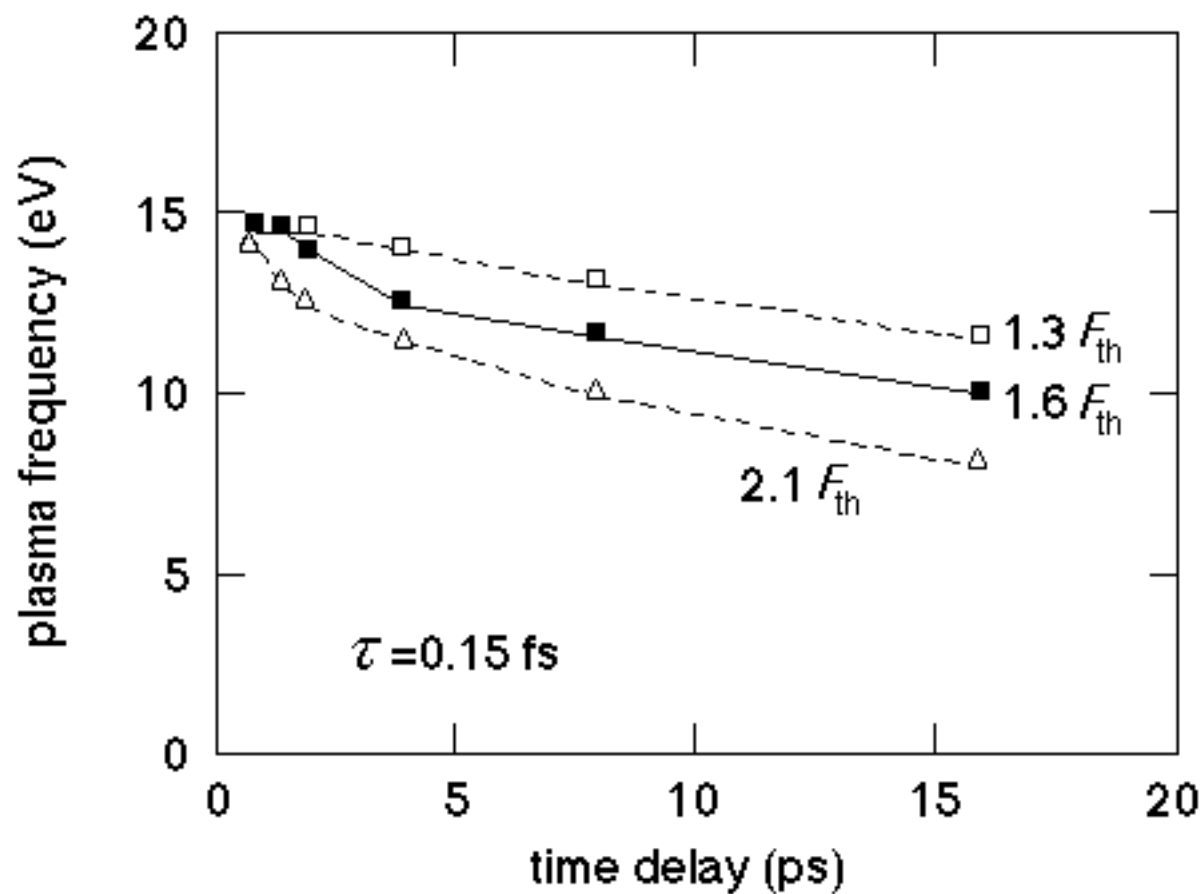

CARRIER DENSITY

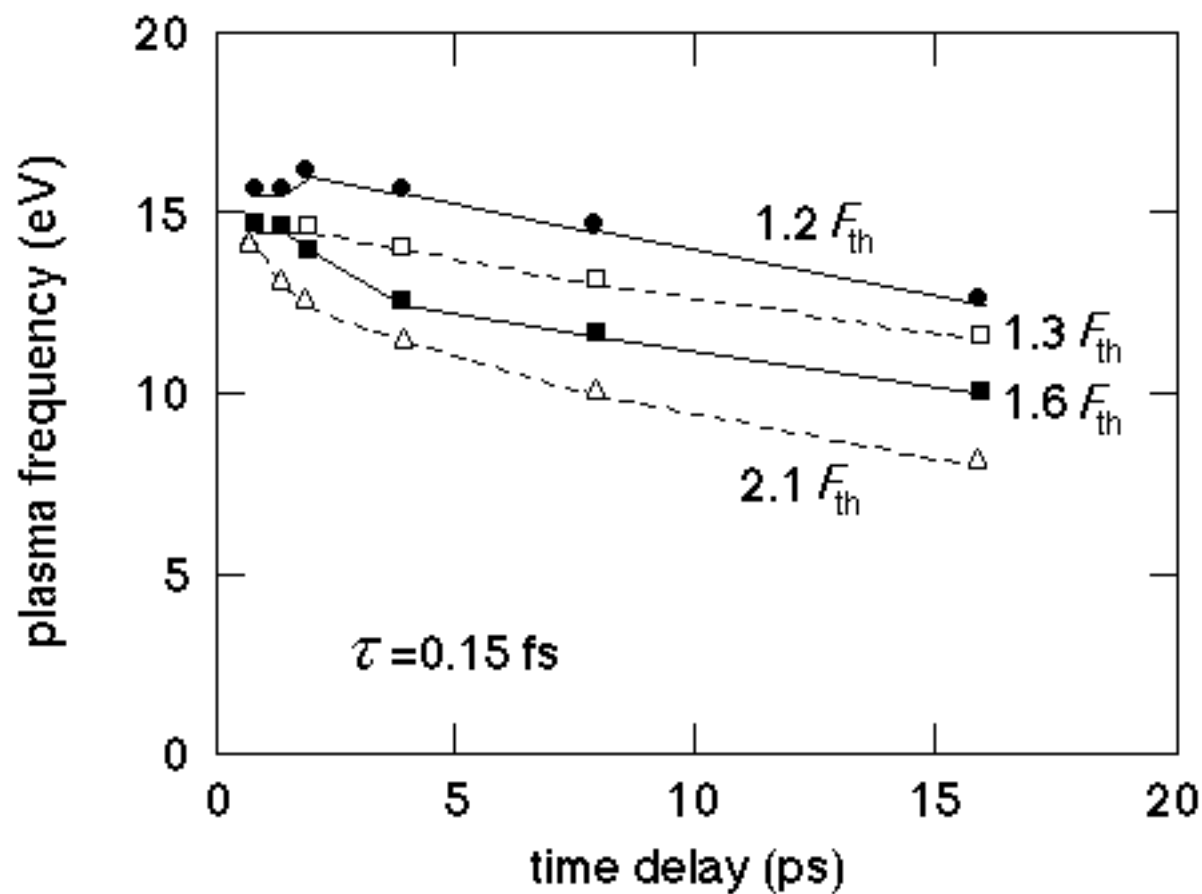

CARRIER DENSITY

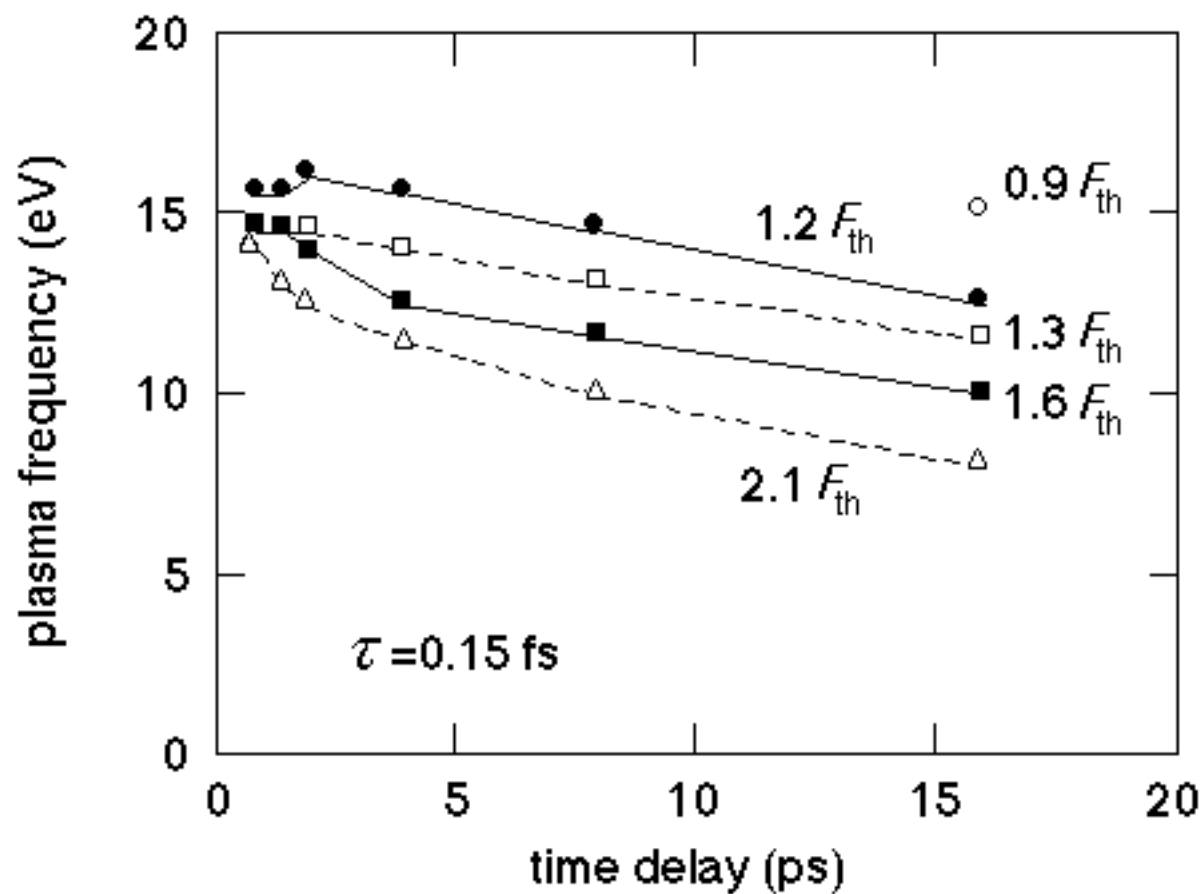

- ① Method
- ② Results
- ③ Discussion



LOW FLUENCE DATA

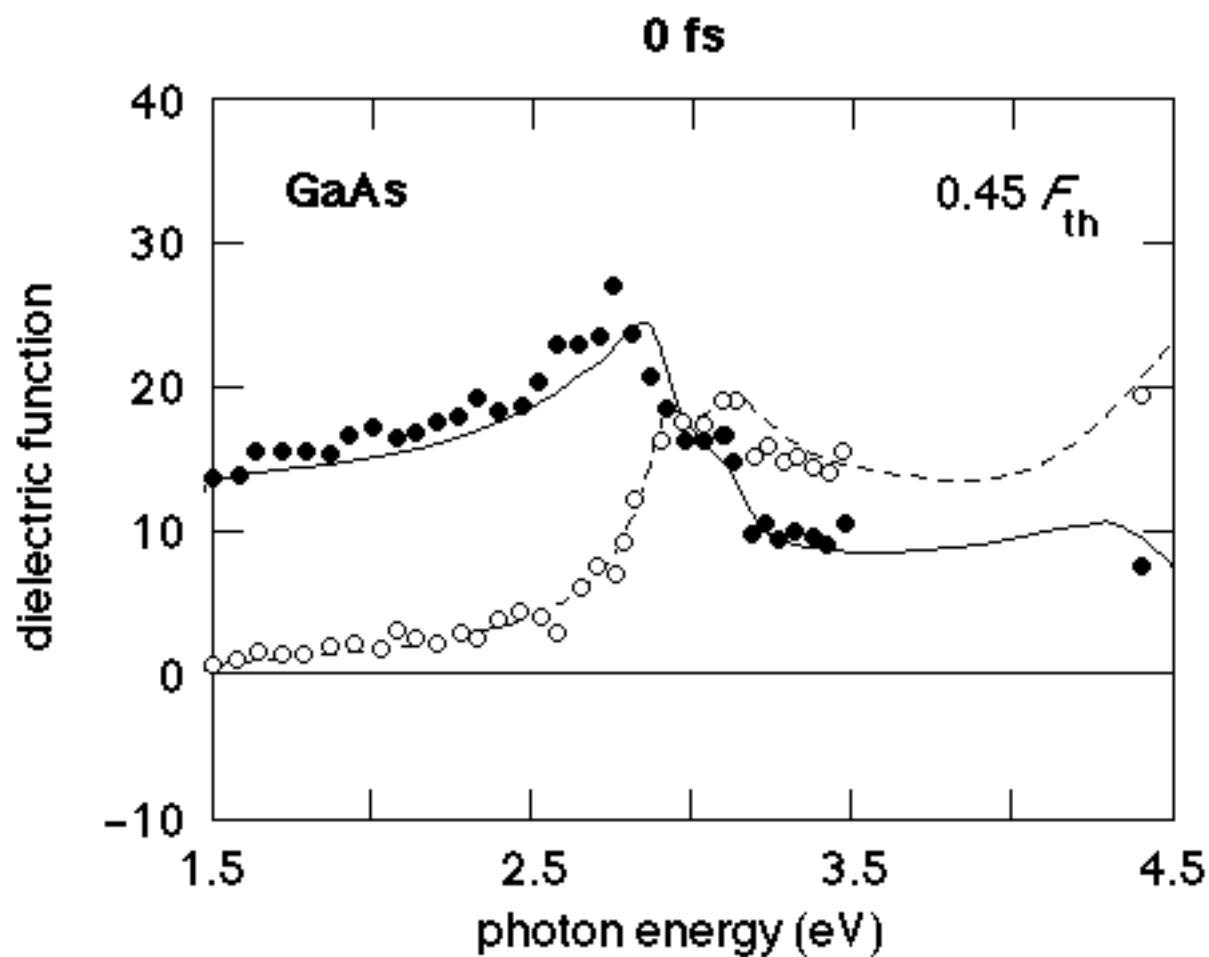

DISCUSSION

structure

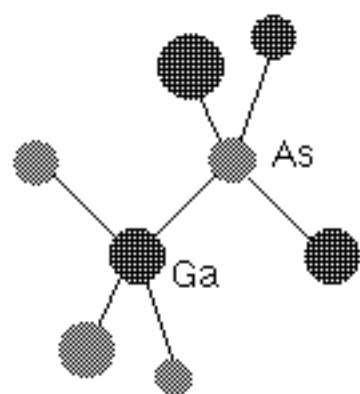

bandstructure

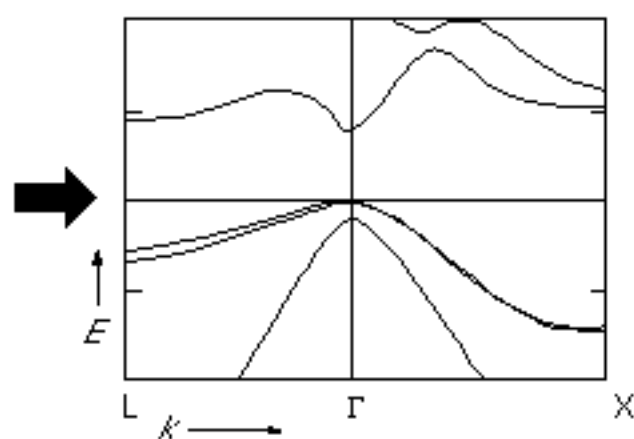

dielectric function

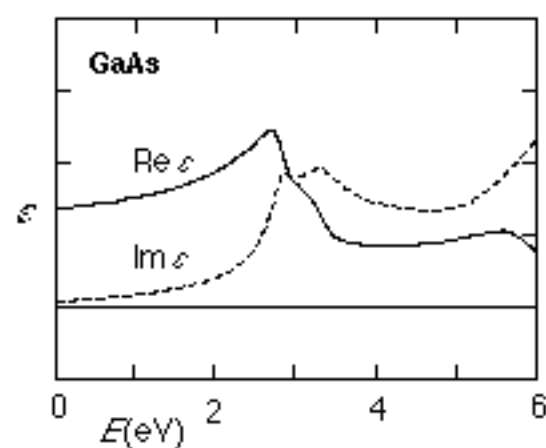

SHORT TIME SCALE (≈ 0.5 ps)

structure

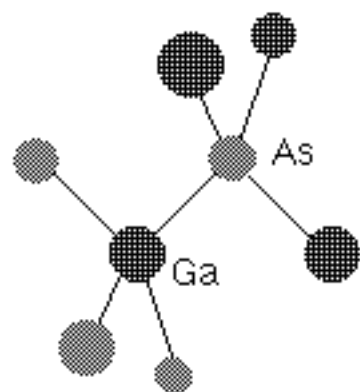

bandstructure

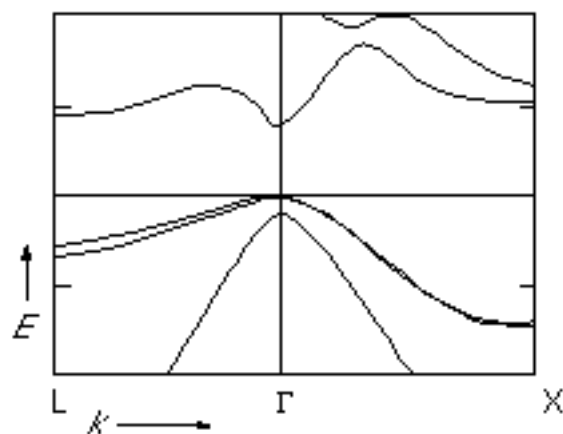

dielectric function

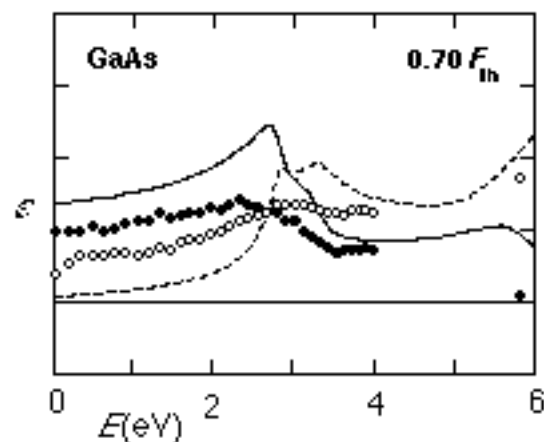

SHORT TIME SCALE (≈ 0.5 ps)

structure

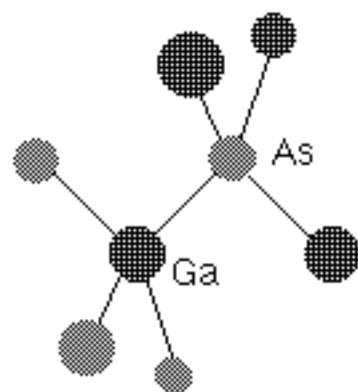

bandstructure

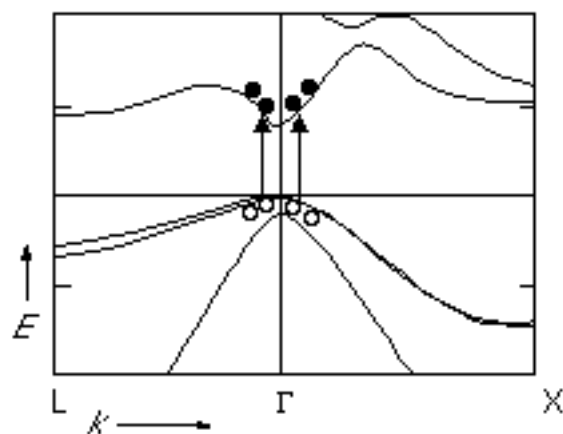

dielectric function

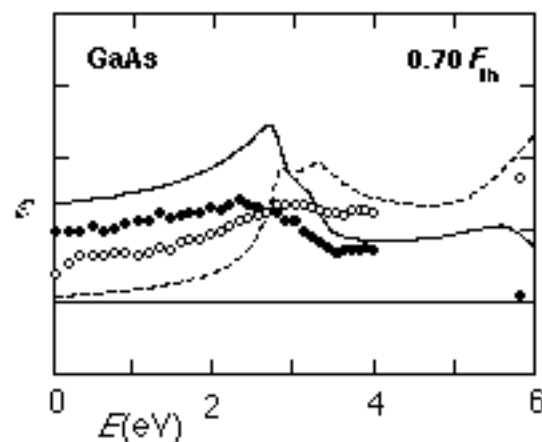

SHORT TIME SCALE (≈ 0.5 ps)

structure

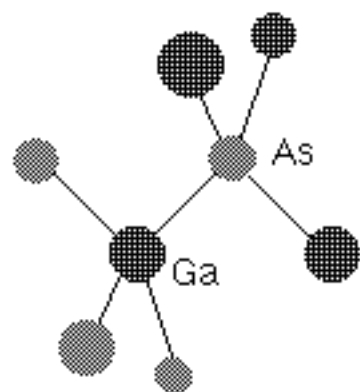

bandstructure

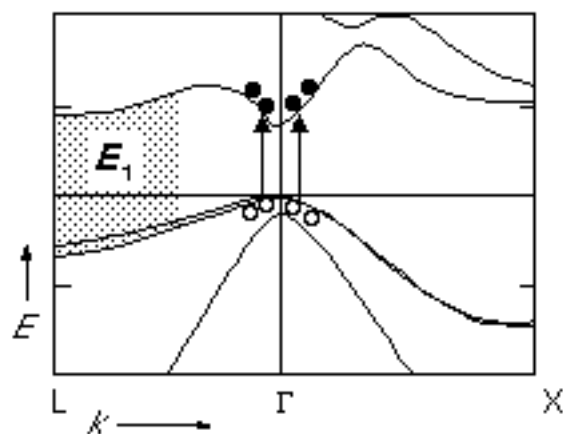

dielectric function

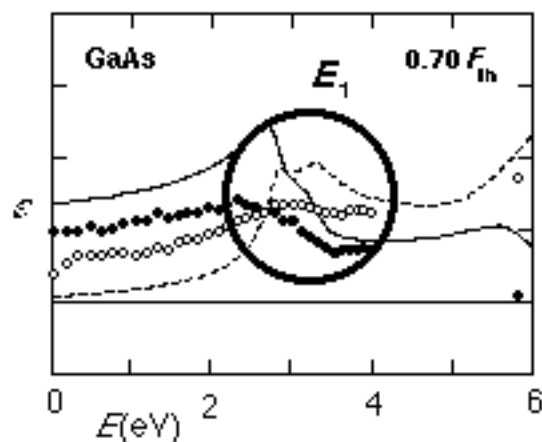

SHORT TIME SCALE (≈ 0.5 ps)

structure

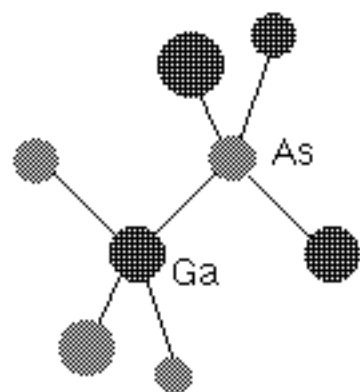

bandstructure

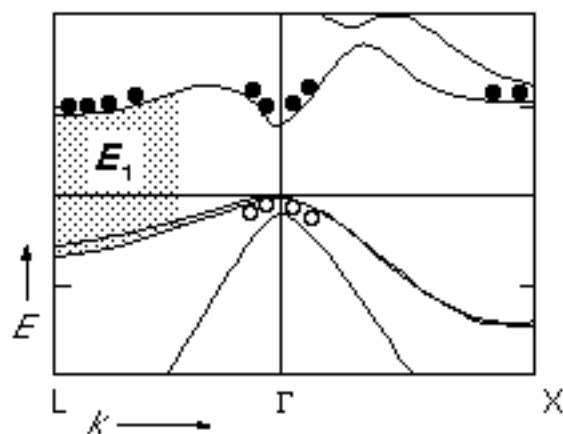

dielectric function

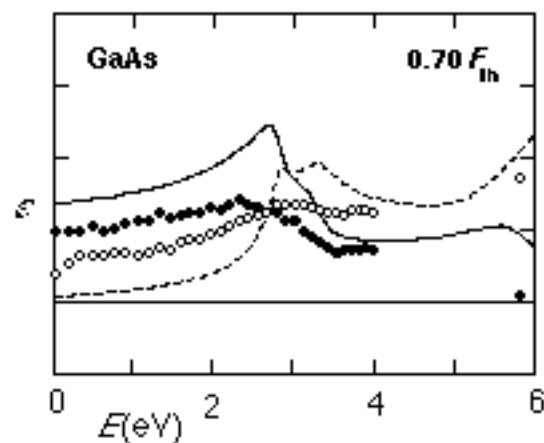

SHORT TIME SCALE (≈ 0.5 ps)

structure

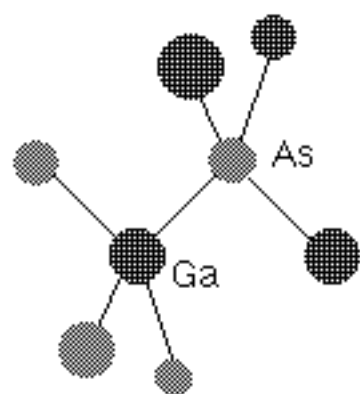

bandstructure

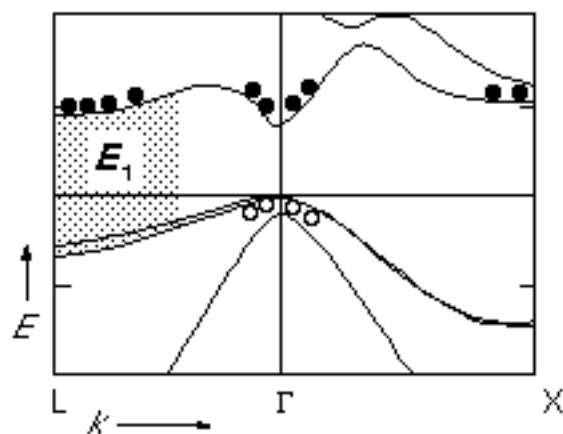

dielectric function

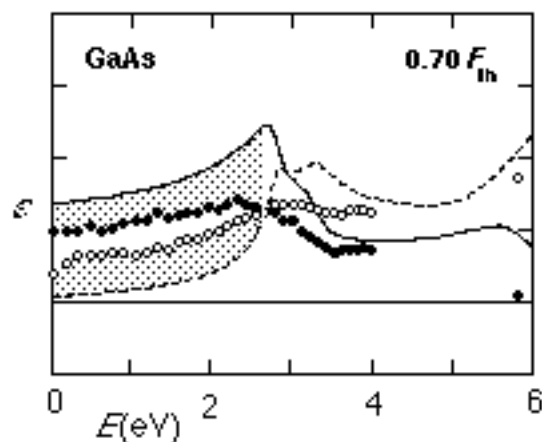

SHORT TIME SCALE (≈ 0.5 ps)

structure

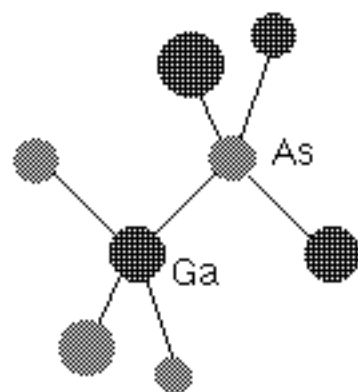

bandstructure

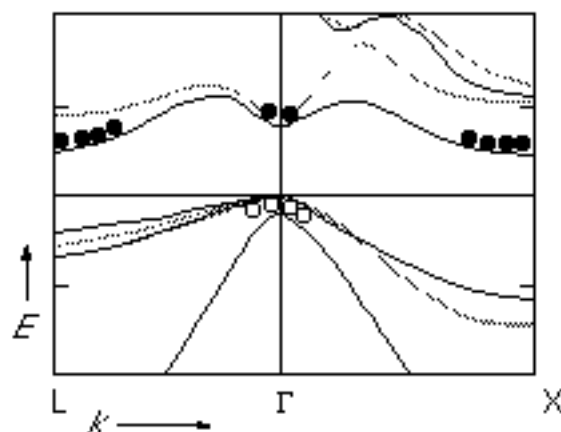

dielectric function

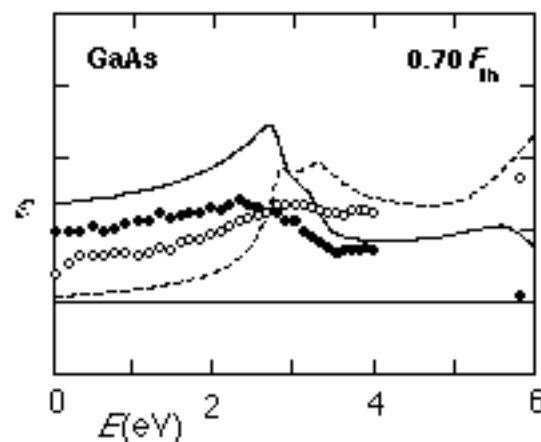

S. Froyen *et al.*, *Phys Rev. B* **28** (1983) 3258

D.H. Kim *et al.*, *Sol. State. Comm.* **89** (1994) 119



SHORT TIME SCALE (≈ 0.5 ps)

structure

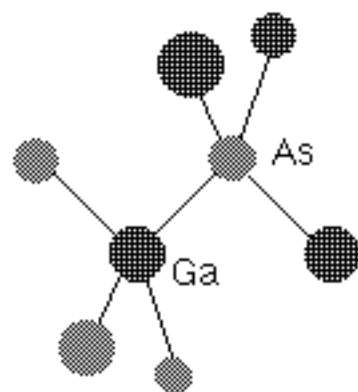

bandstructure

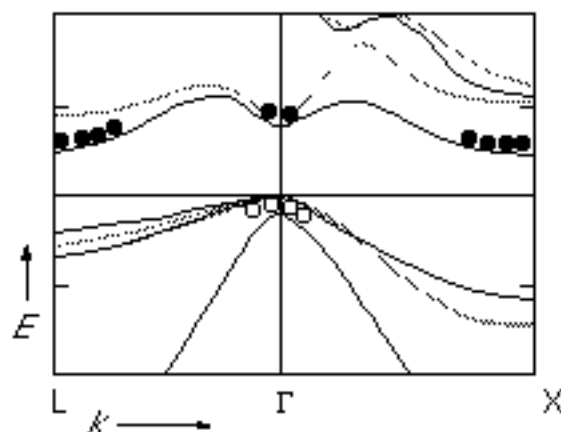

dielectric function

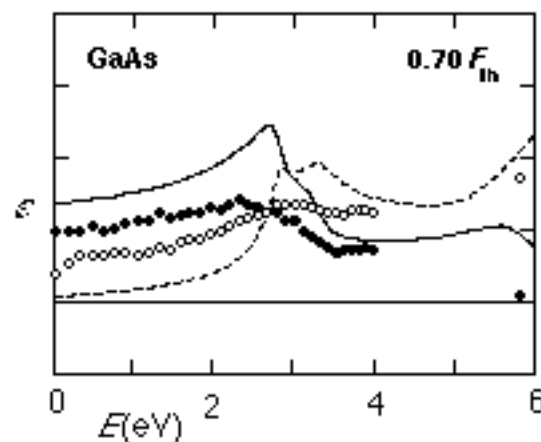

► electronic effects dominate at short time scales...



SHORT TIME SCALE (≈ 0.5 ps)

structure

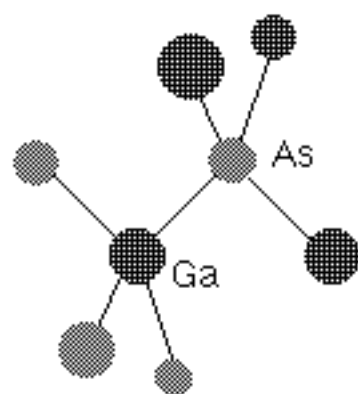

bandstructure

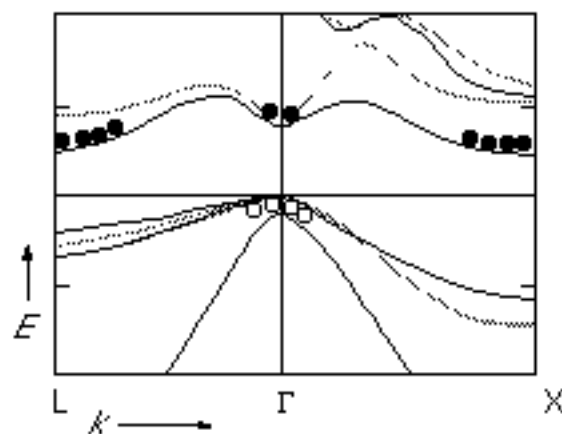

dielectric function

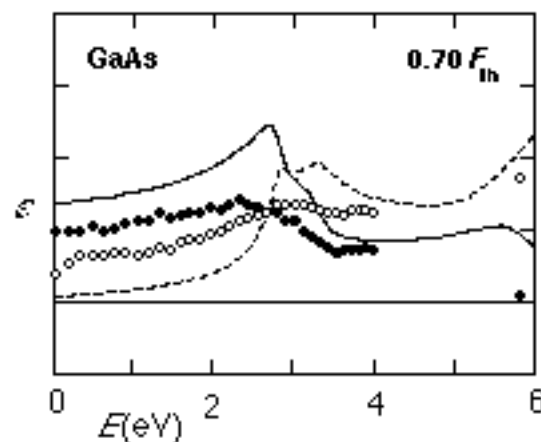

► ...but they are not as simple as we used to think



LOW FLUENCE, LONG TIME SCALE

structure

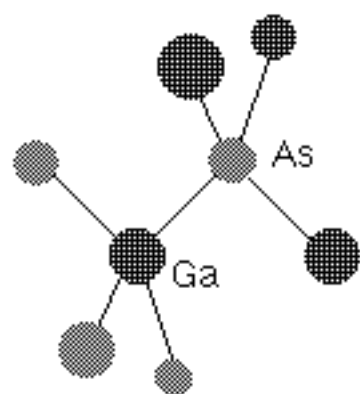

bandstructure

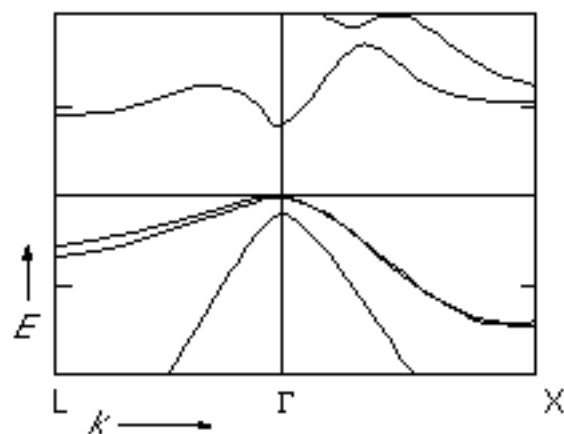

dielectric function

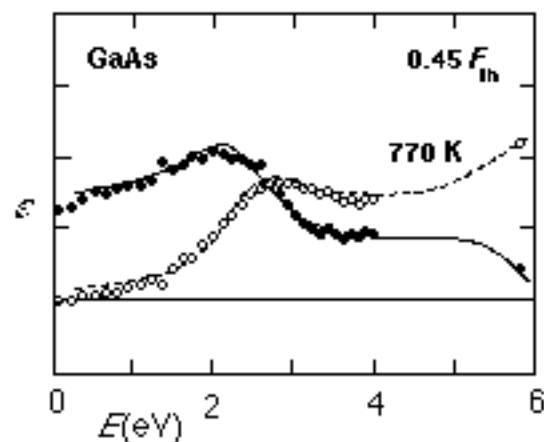

LOW FLUENCE, LONG TIME SCALE

structure

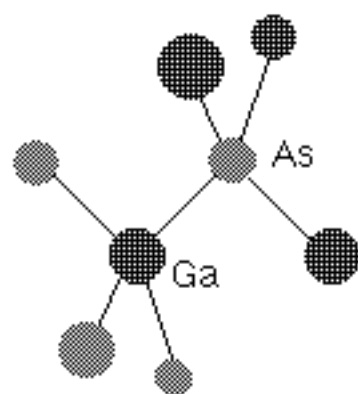

bandstructure

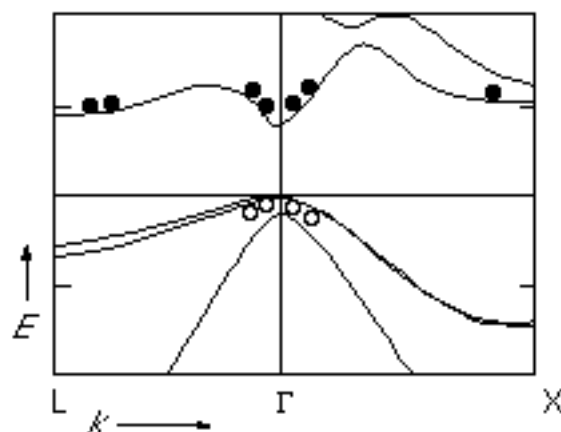

dielectric function

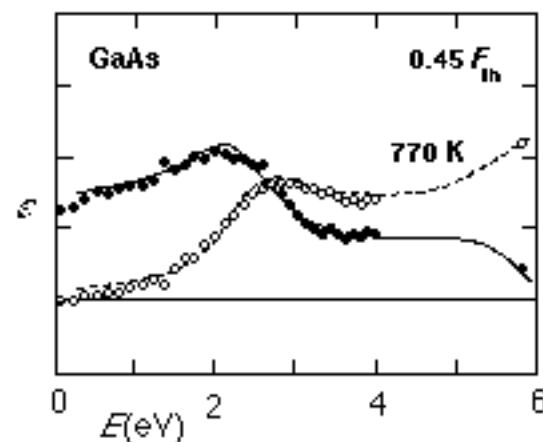

carrier density down, electronic effects subsided...



LOW FLUENCE, LONG TIME SCALE

structure

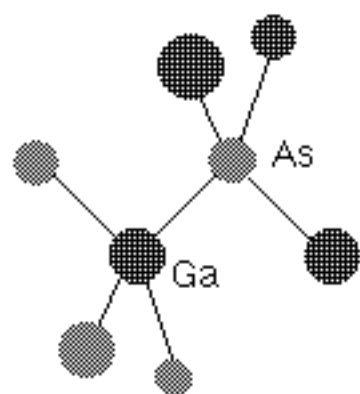

bandstructure

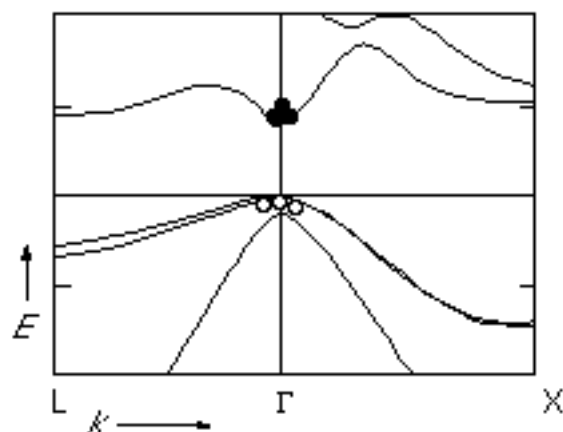

dielectric function

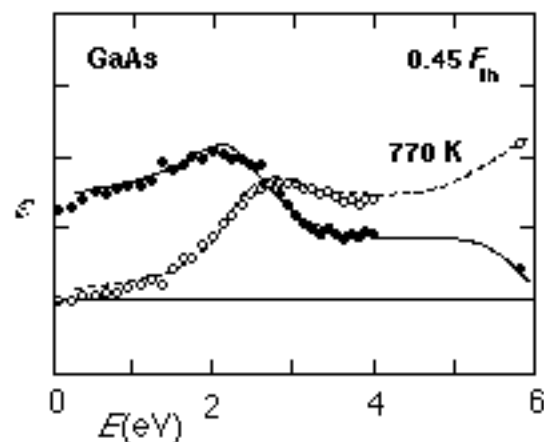

...and lattice heats due to carrier relaxation



LOW FLUENCE, LONG TIME SCALE

structure

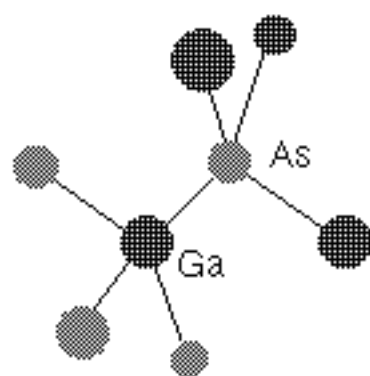

bandstructure

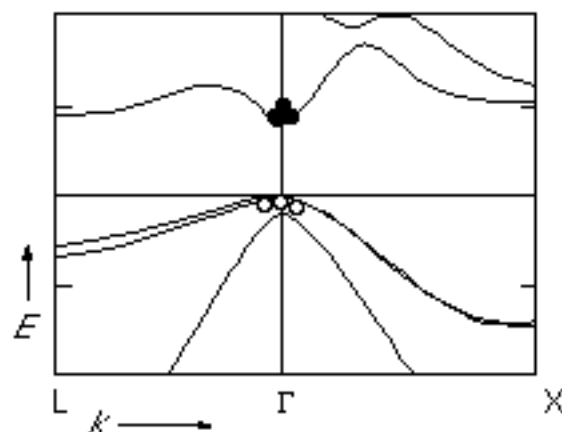

dielectric function

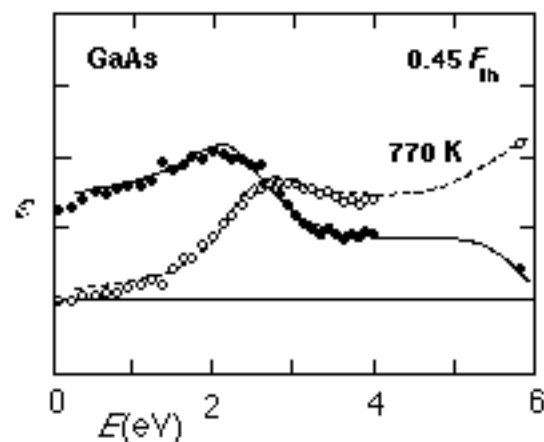

...and lattice heats due to carrier relaxation



HIGH FLUENCE, LONG TIME SCALE

structure

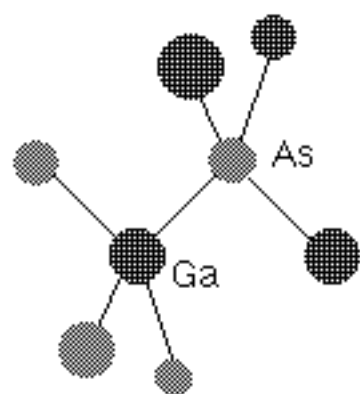

bandstructure

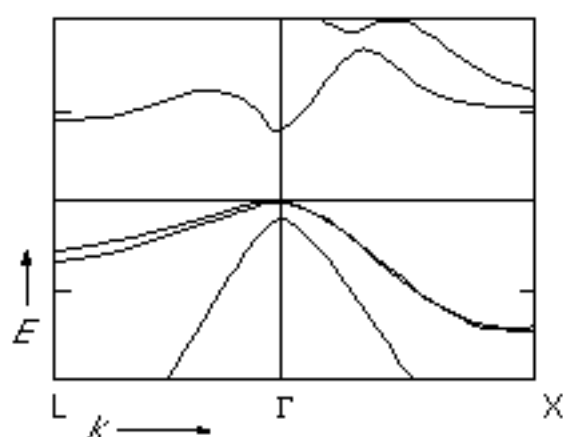

dielectric function

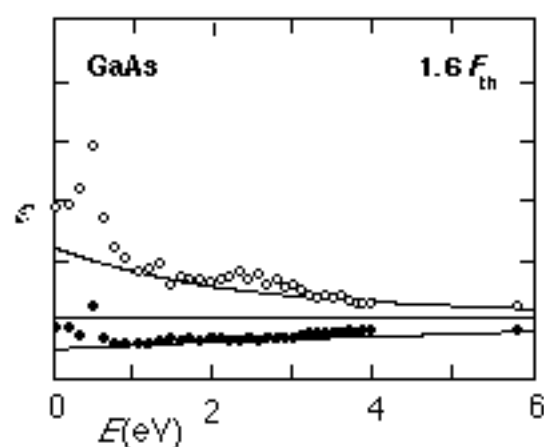

gradual drop in gap \rightarrow not electronic effect



HIGH FLUENCE, LONG TIME SCALE

structure

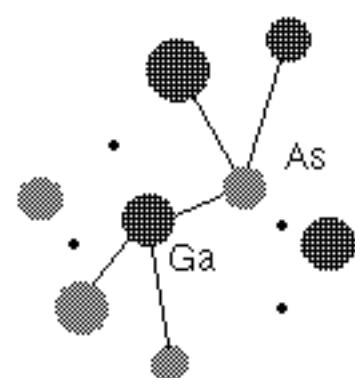

bandstructure

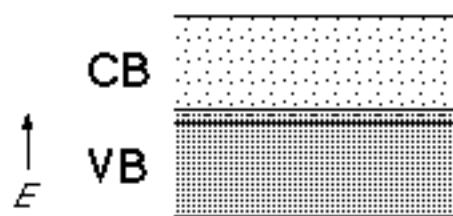

dielectric function

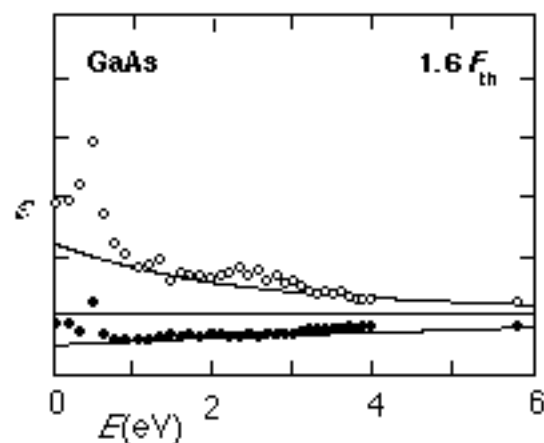

BROADBAND DATA

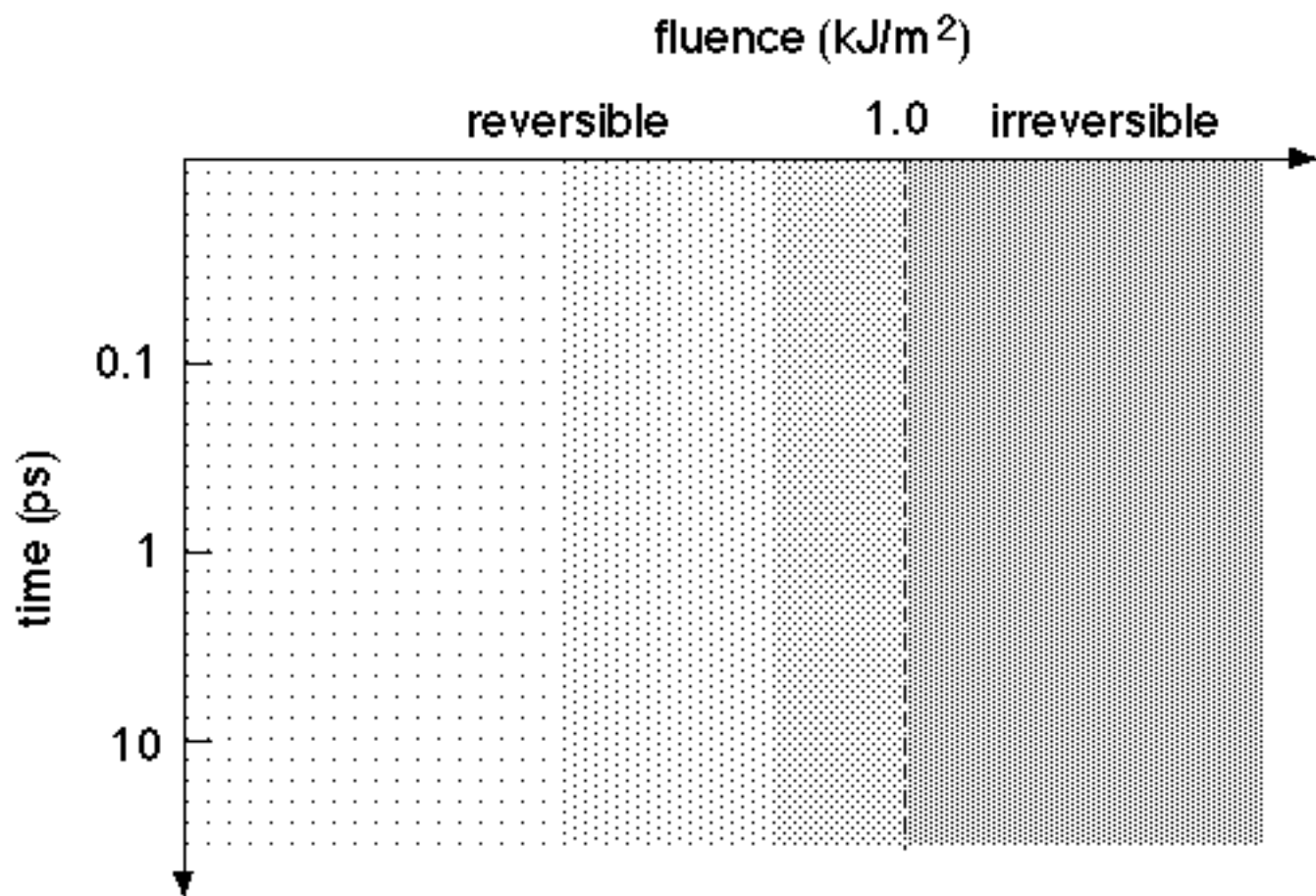

BROADBAND DATA

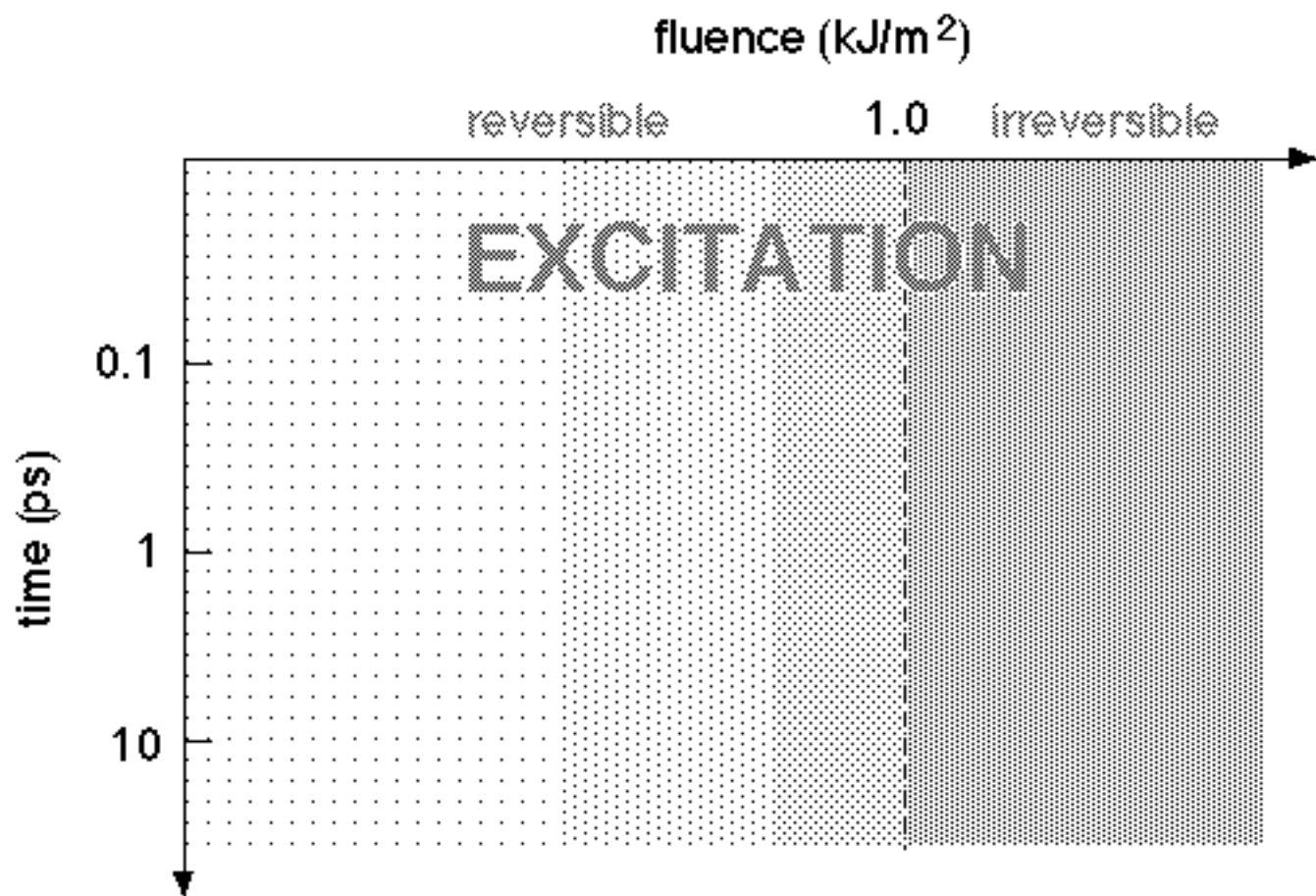

BROADBAND DATA

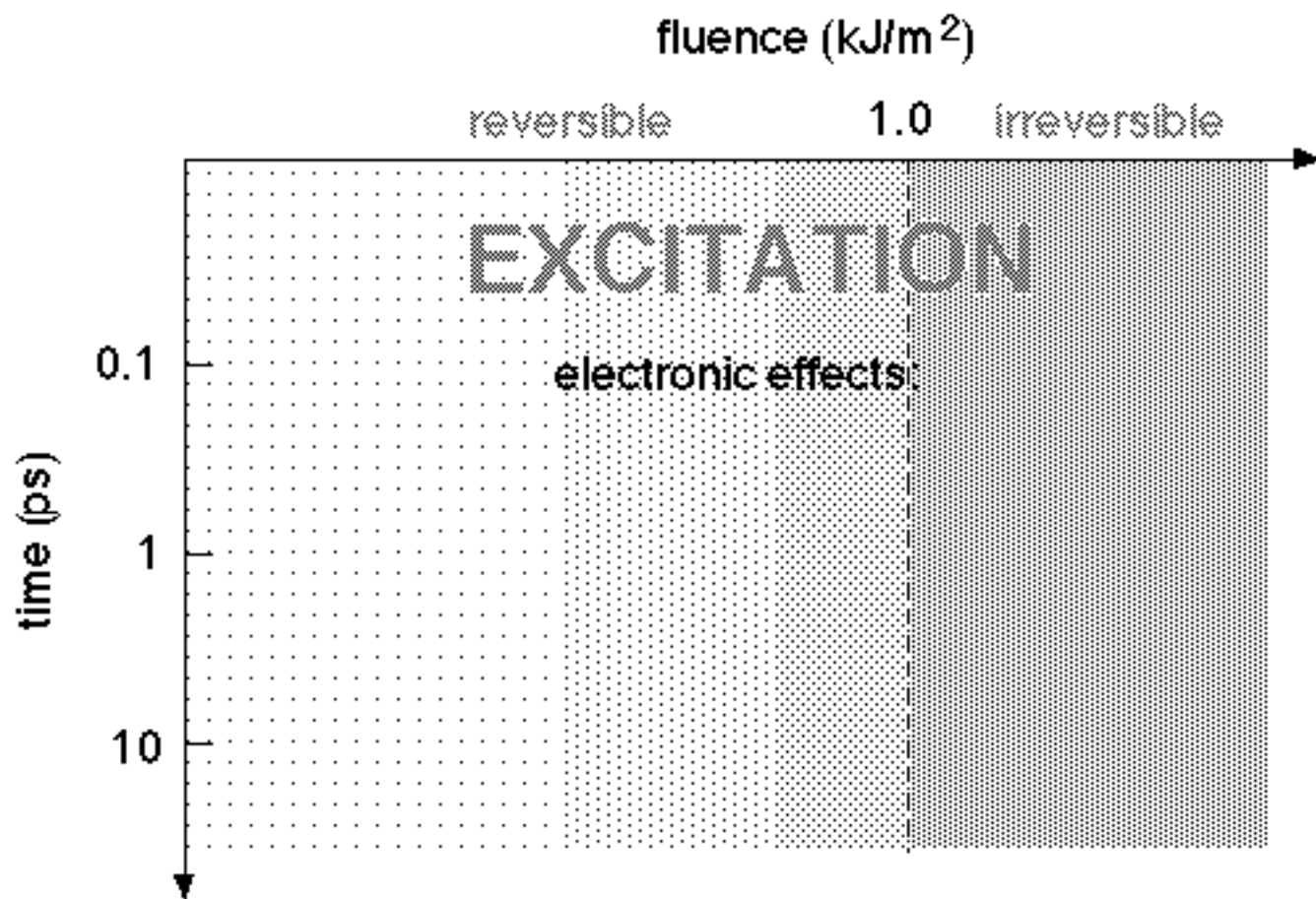

BROADBAND DATA

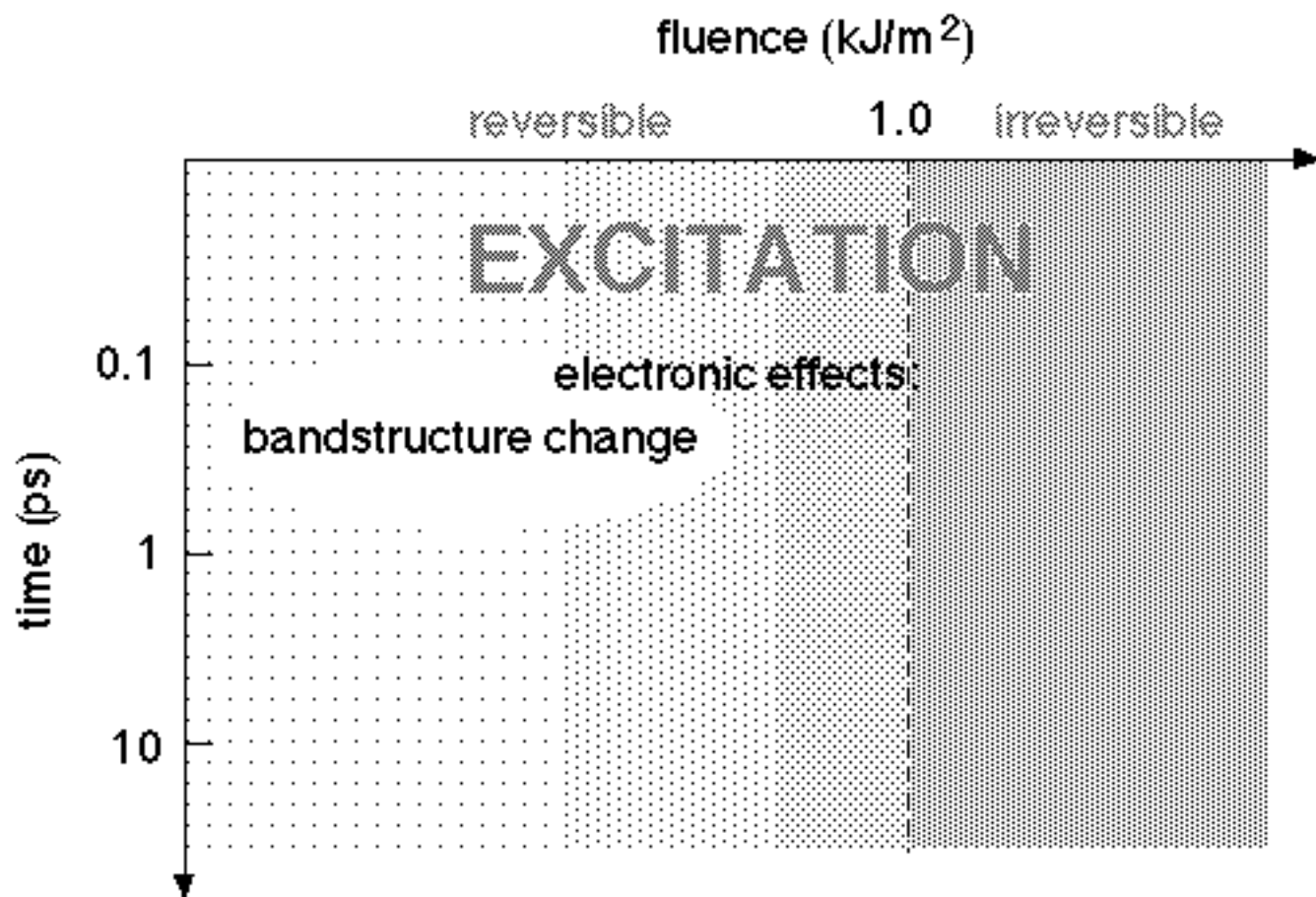

BROADBAND DATA

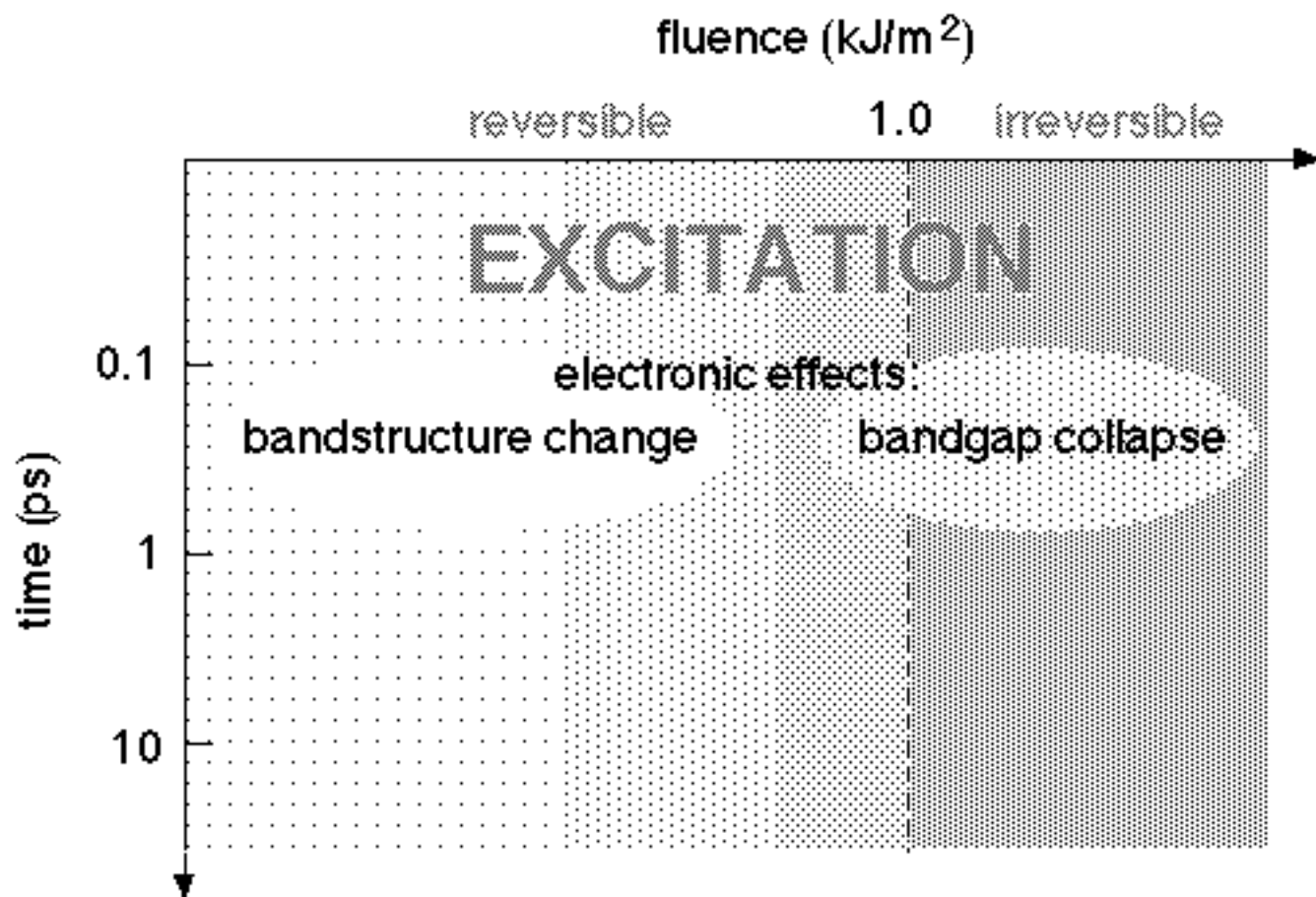

BROADBAND DATA

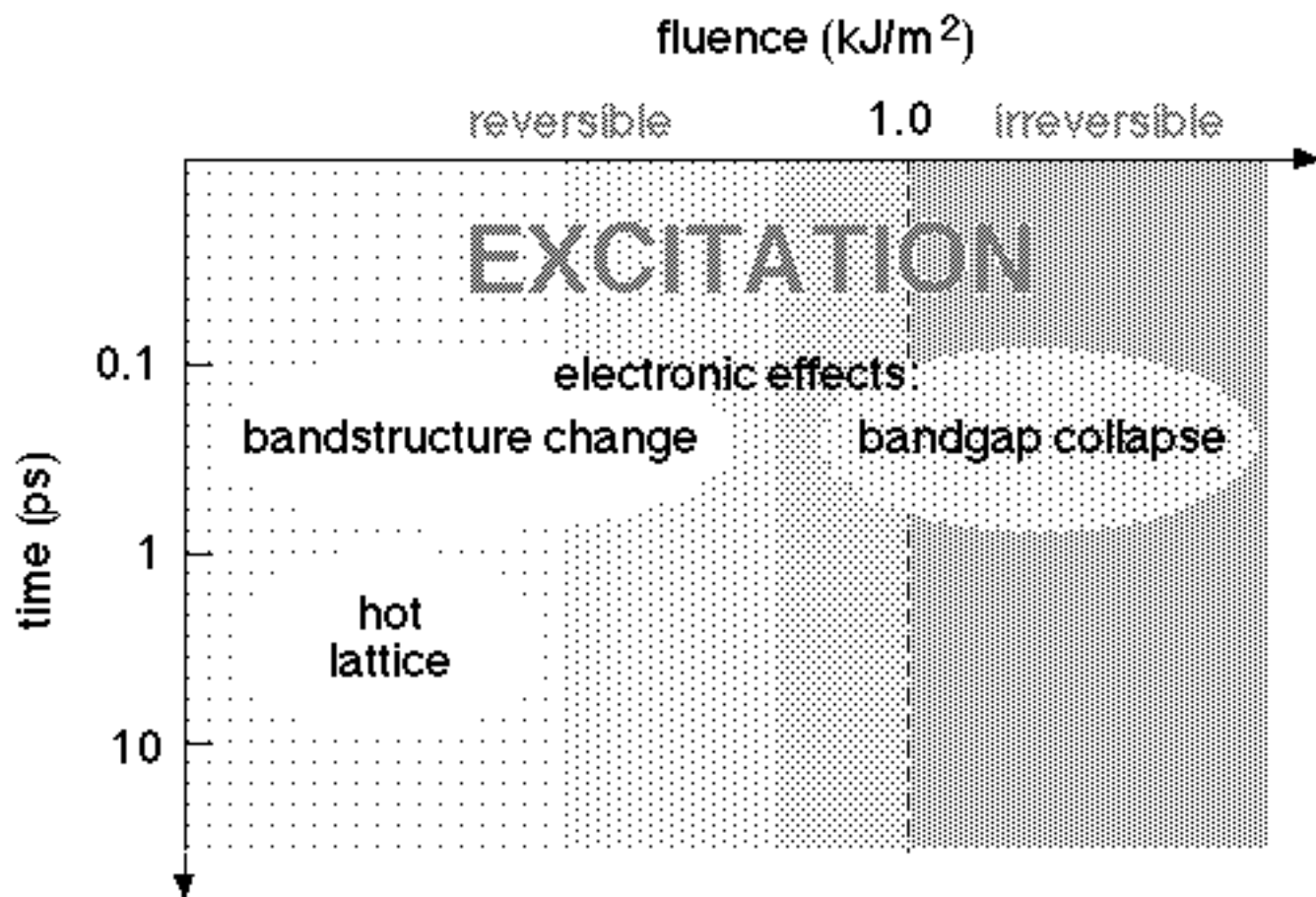

BROADBAND DATA

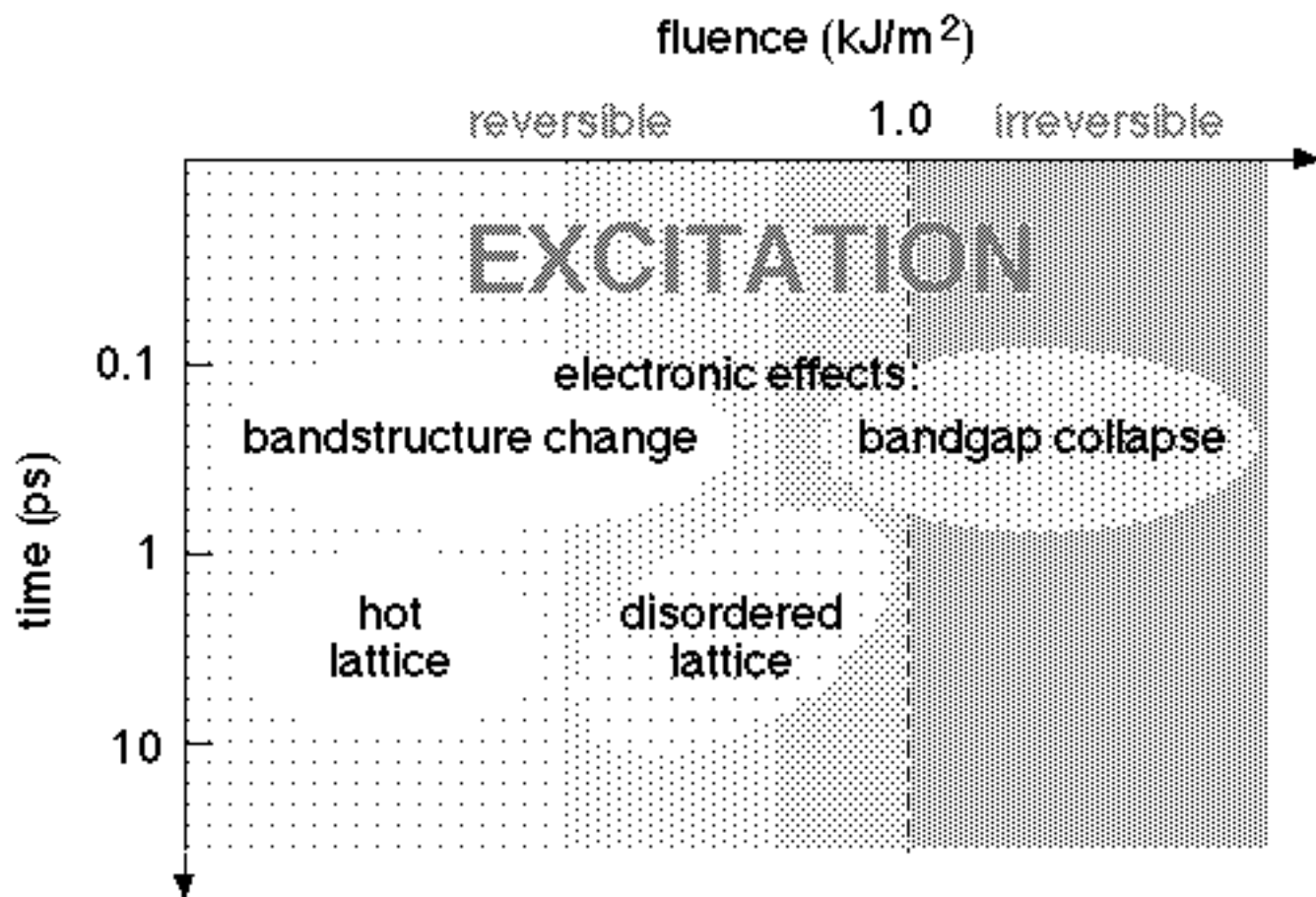

BROADBAND DATA

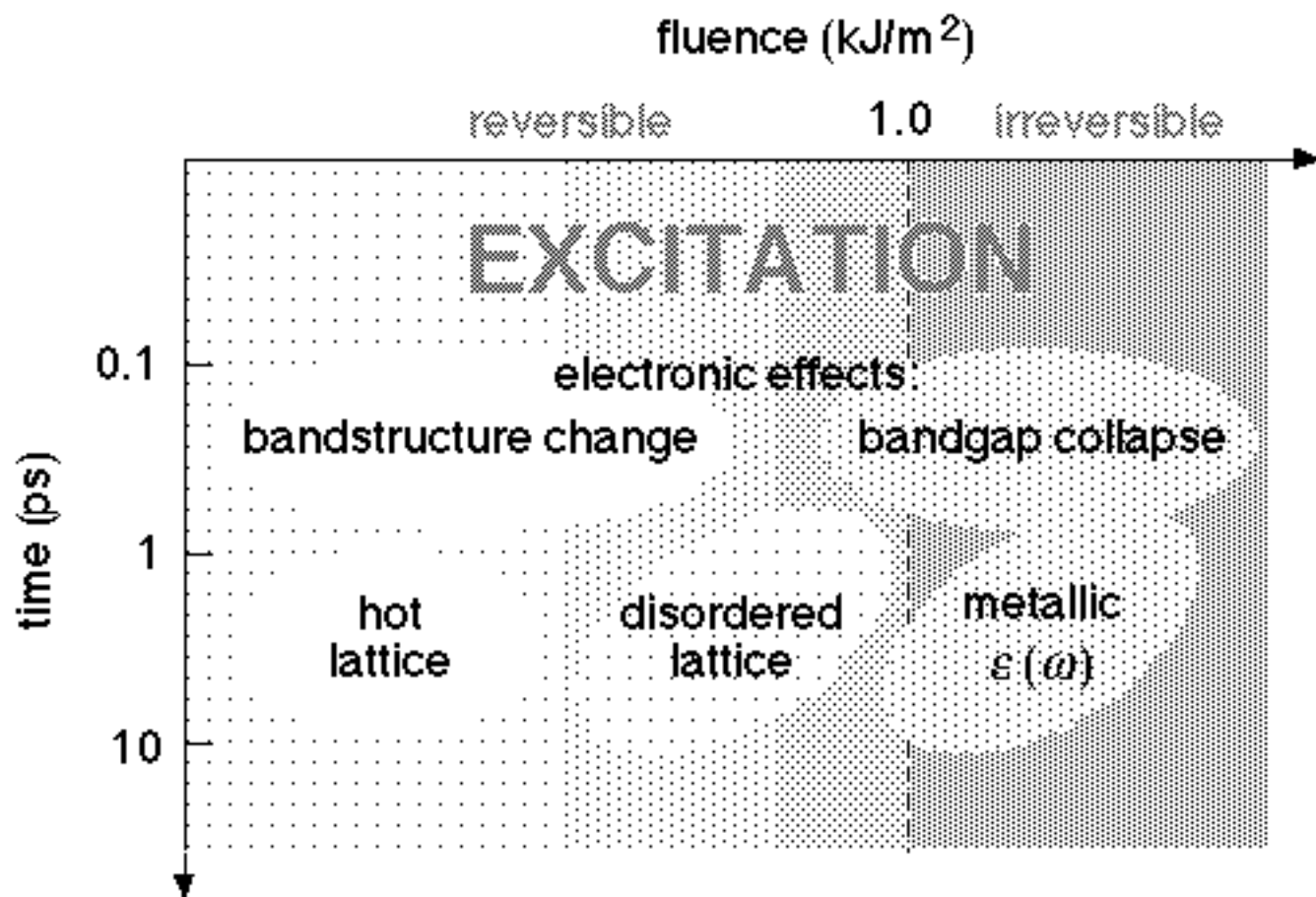

- ▶ measurement of $\epsilon(\omega)$ identifies ultrafast phase changes
- ▶ initial response is electronic, via band structure and electron occupation changes
- ▶ structural effects dominate after a few ps
- ▶ interesting reversible regime

- ▶ strong electronic excitation can drive a structural transition
- ▶ femtosecond lasers allow us to see the dynamics of the transition



Prof. Bloembergen
Prof. Ehrenreich
Prof. Kaxiras
Prof. Klingshirn

ONR, NSF

<http://mazur-www.harvard.edu>

