

Wrapping light around a hair

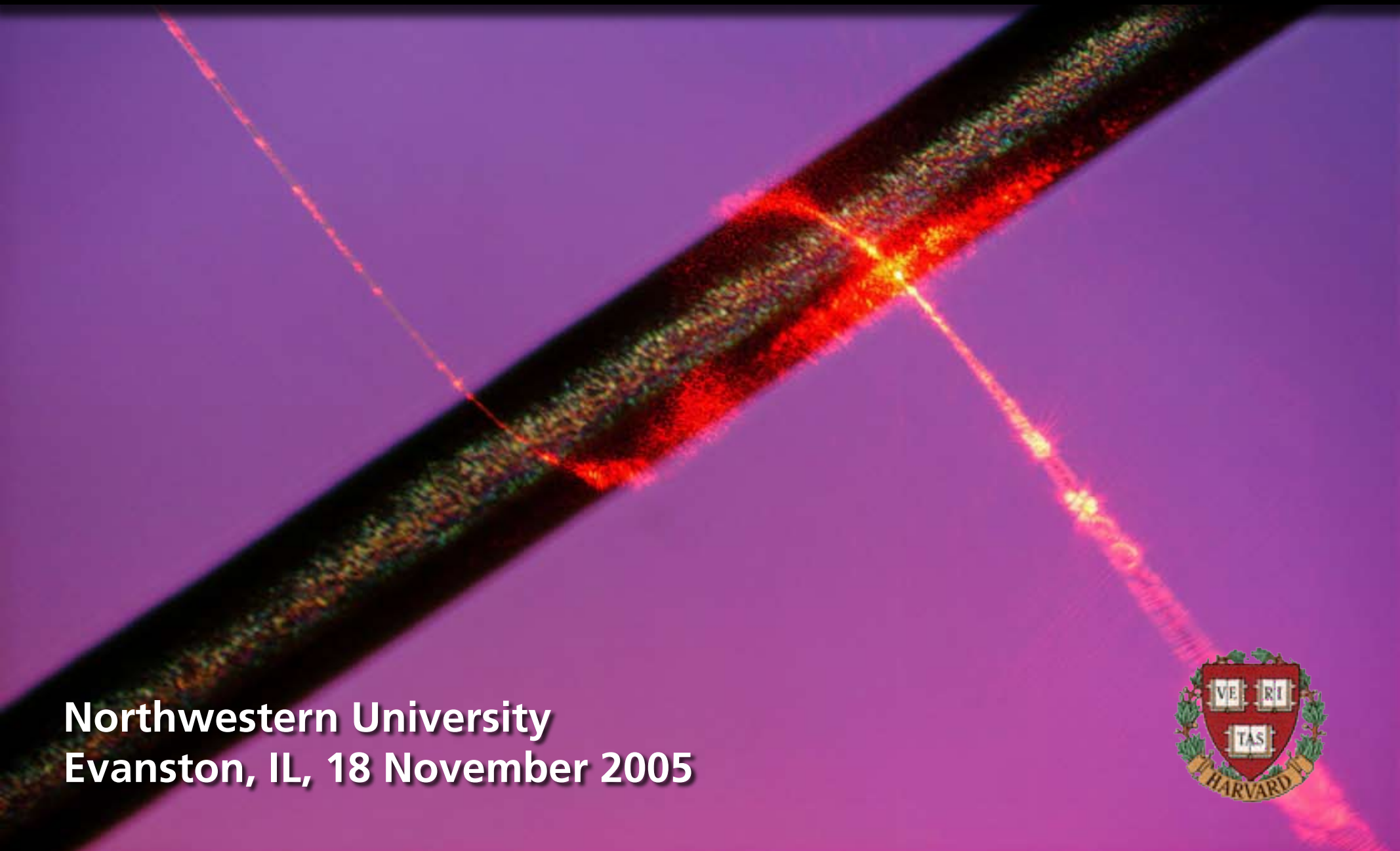

Northwestern University
Evanston, IL, 18 November 2005

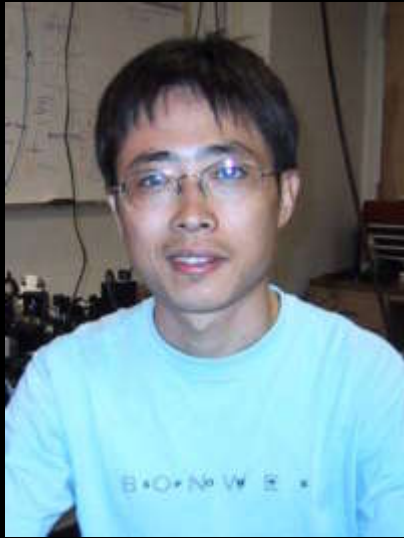



Limin Tong



Rafael Gattass



Geoff Svacha



Tommaso Baldacchini

and also....

at Harvard:

Jonathan Aschom

Mengyan Shen

Iva Maxwell

James Carey

Brian Tull

Dr. Yuan Lu

Dr. Richard Schalek

Prof. Federico Capasso

Prof. Cynthia Friend

and elsewhere:

Xuwen Chen (Zhejiang University)

Zhanghua Han (Zhejiang University)

Dr. Sailing He (Zhejiang University)

Prof. Igor Khrushev (Aston University)

Dr. Jingyi Lou (Zhejiang University)

Dr. Ray Mariella (LLNL)

Liu Liu (Zhejiang University)

“I managed to illuminate the interior of a stream in a dark space. I have discovered that this strange arrangement offers one of the most beautiful, and most curious experiments that one can perform in a course on Optics.”

Daniel Colladon, *Comptes Rendus*, 15, 800–802 (1842)

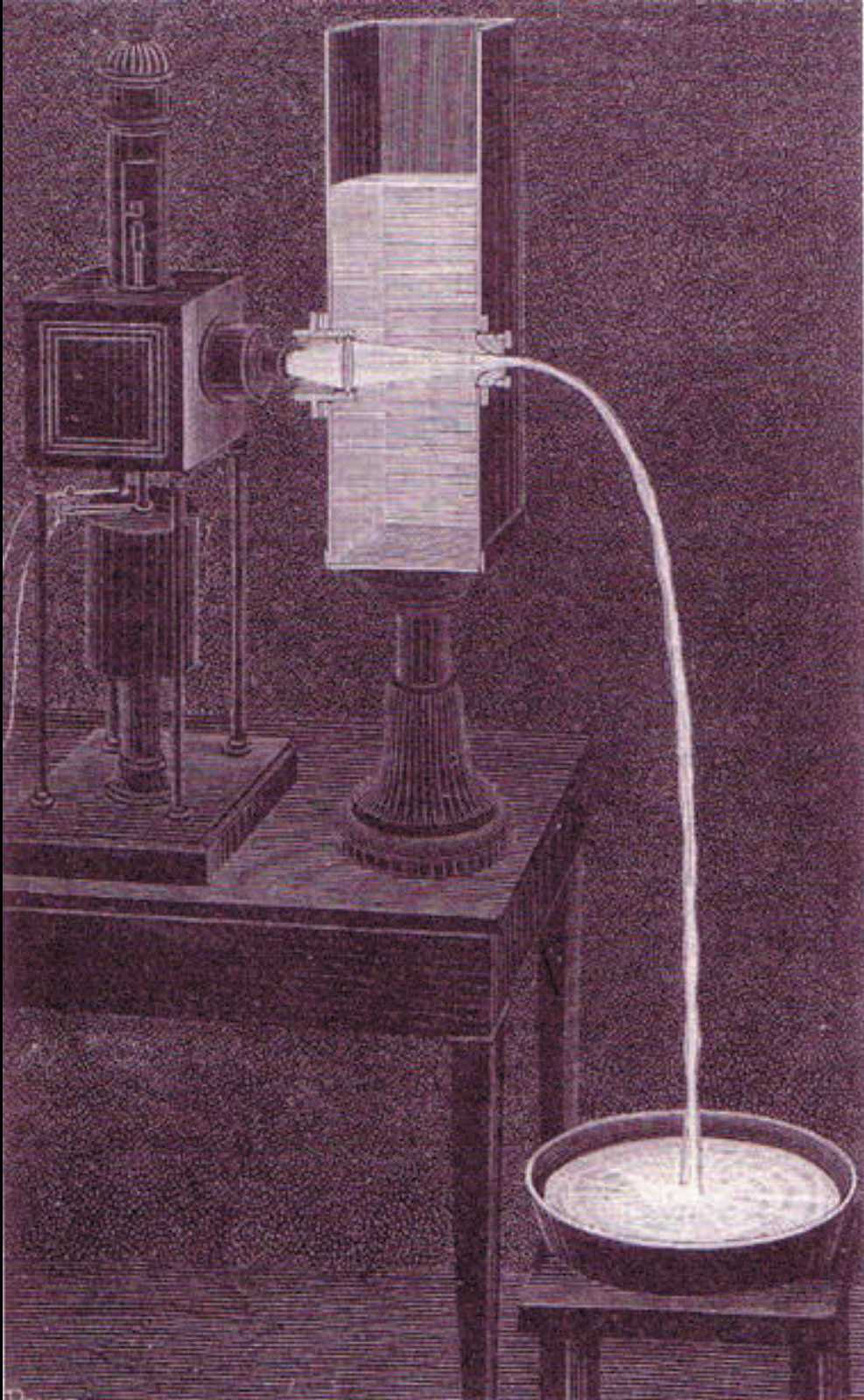

D. Colladon, *La Nature*, 325 (1884)



W. WHEELER.

APPARATUS FOR LIGHTING DWELLINGS OR OTHER STRUCTURES.

No. 247,229.

Patented Sept. 20, 1881.

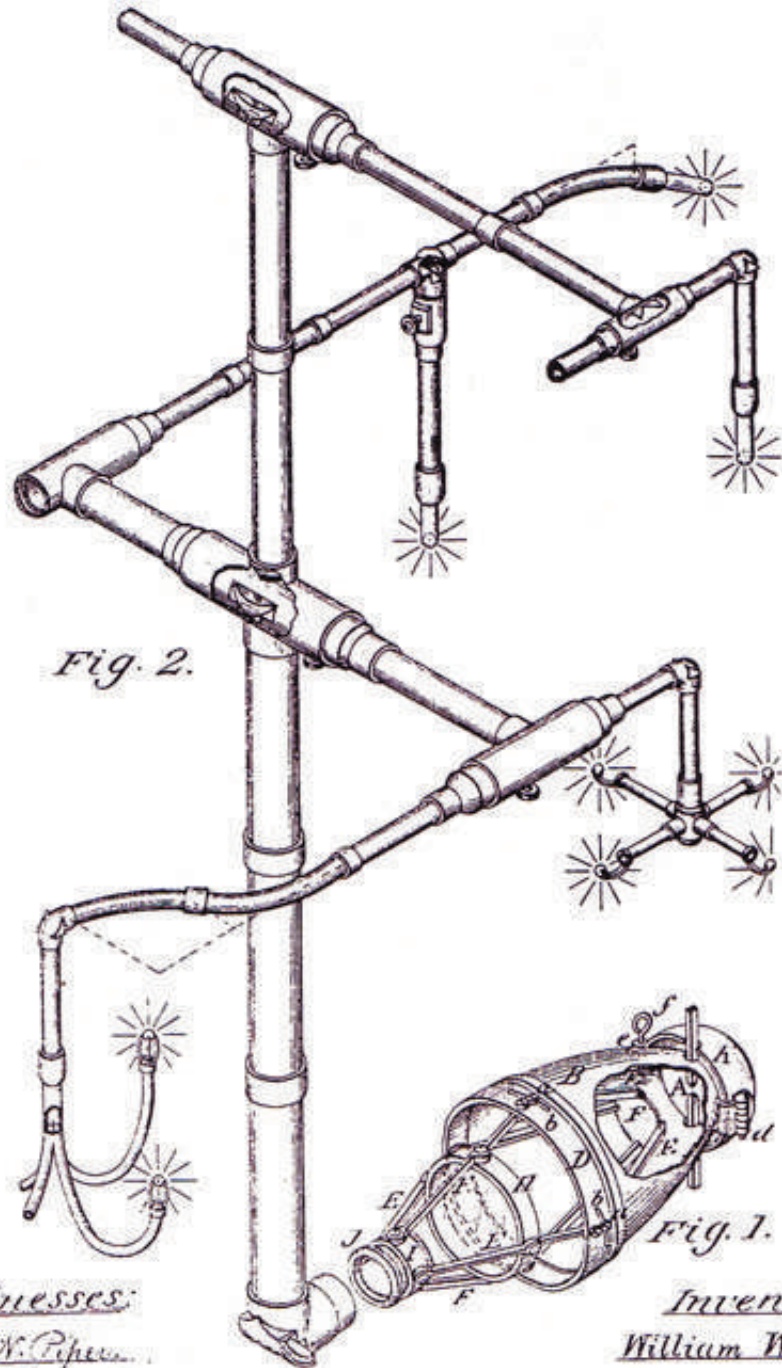

Fig. 2.

Fig. 1.

Witnesses:
J. N. Piper
E. L. [unclear]

Inventor:
William Wheeler
 by attorney
[unclear]

US Patent 247, 229 (1881)

Outline

- waveguiding
- nanowire fabrication
- optical properties

Waveguiding

two crossed planar waves...

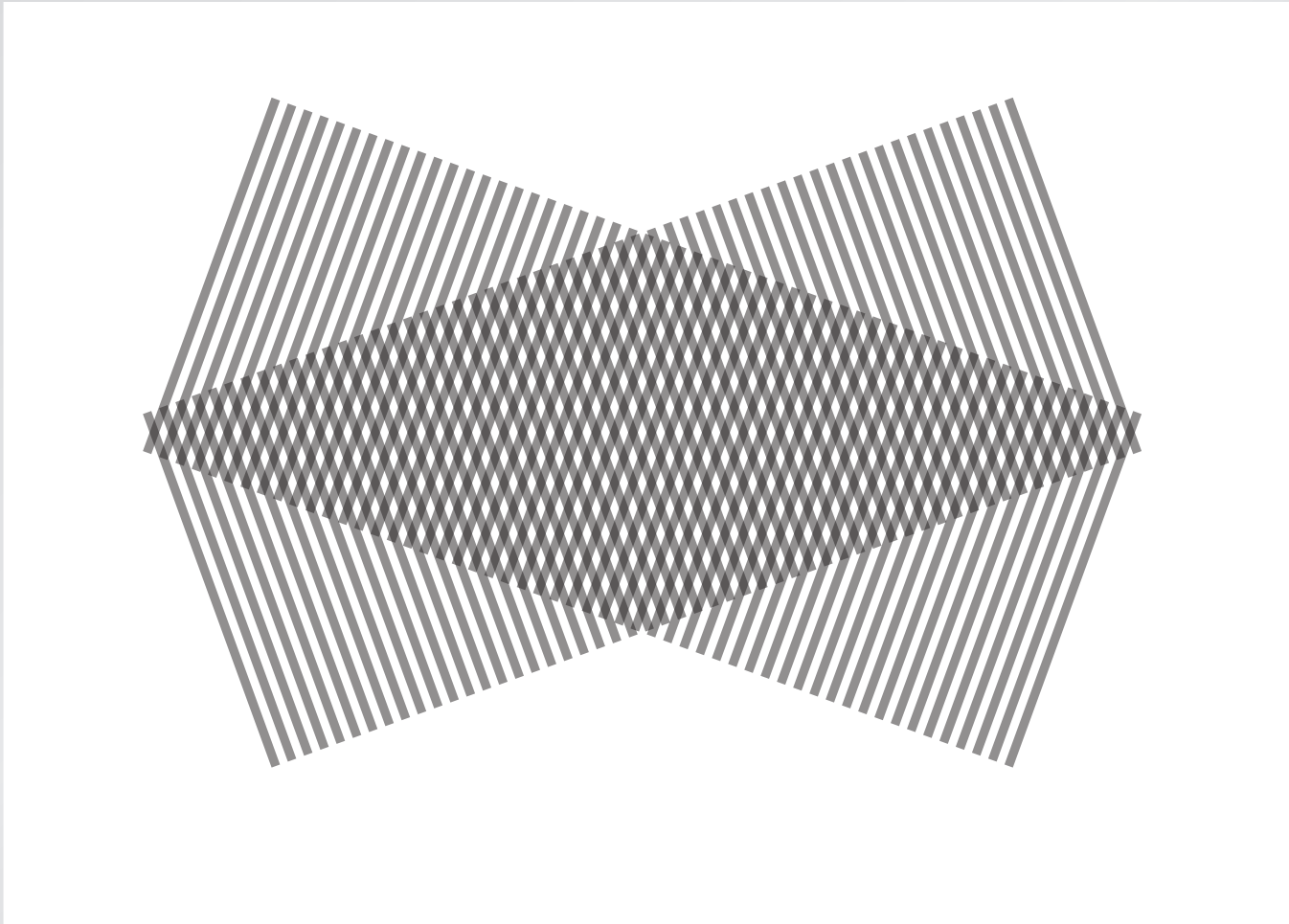

Waveguiding

...cause an interference pattern

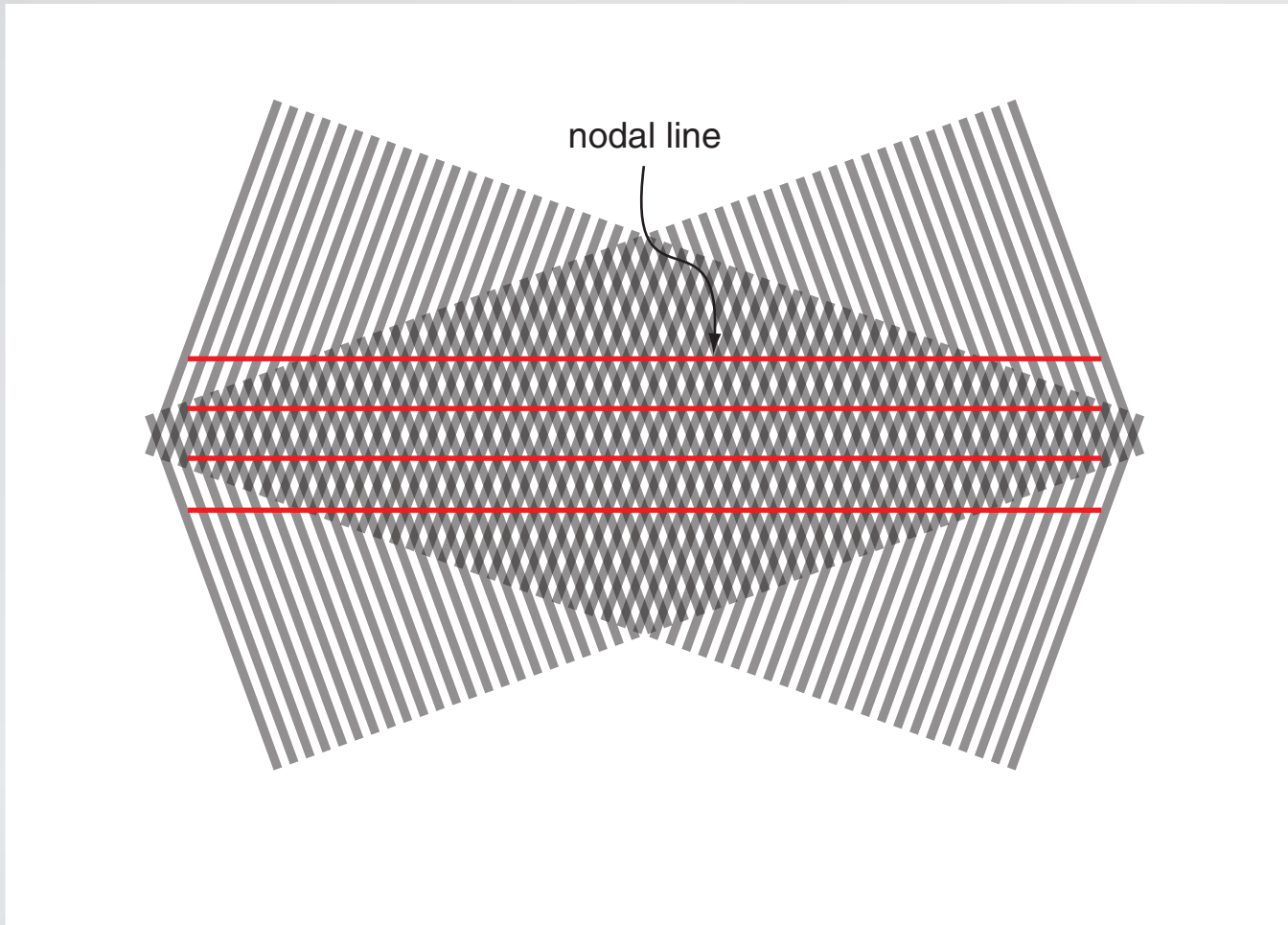

Waveguiding

$E = 0$ on the nodal lines

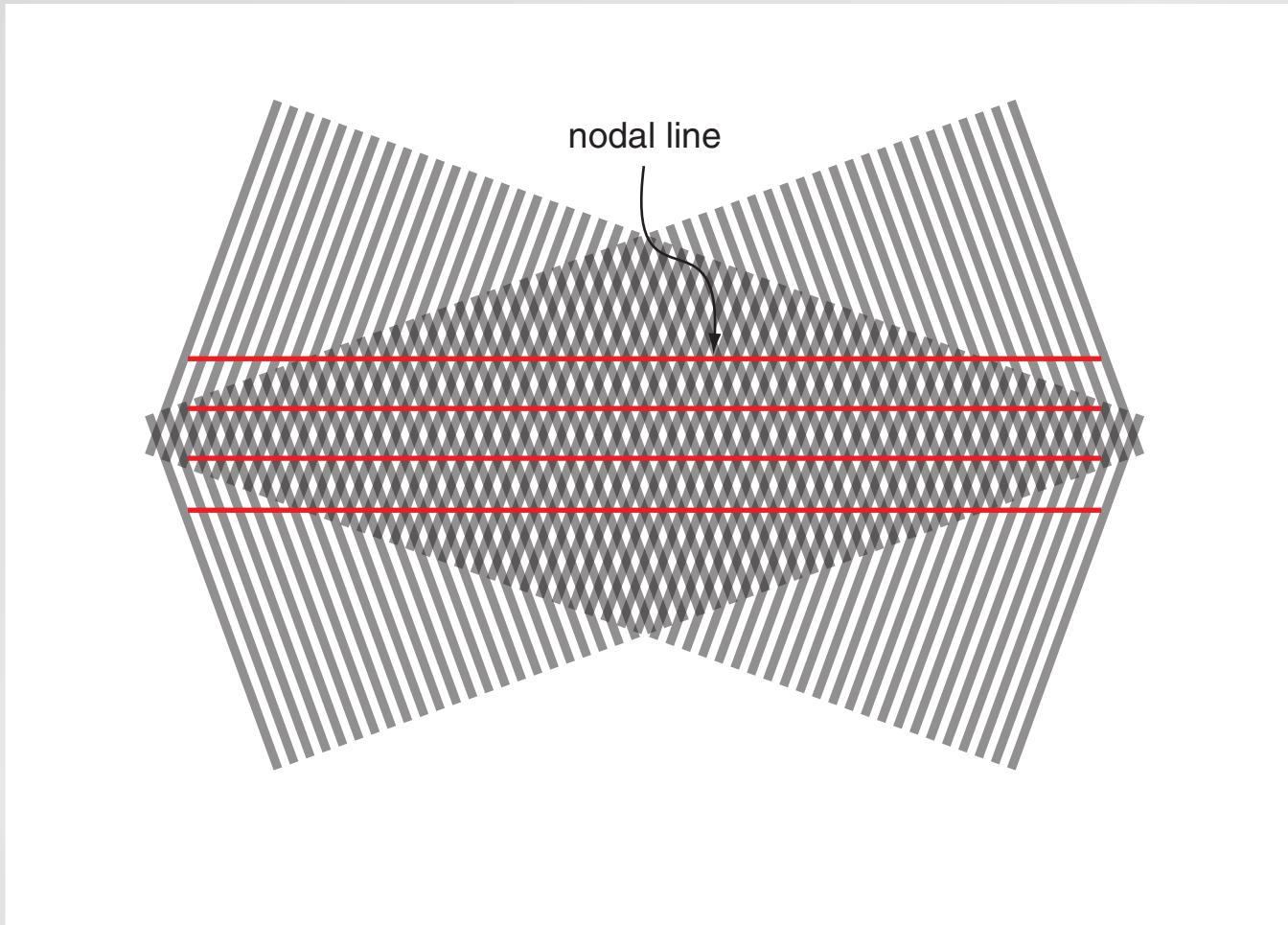

Waveguiding

...satisfying boundary conditions for planar-mirror waveguide

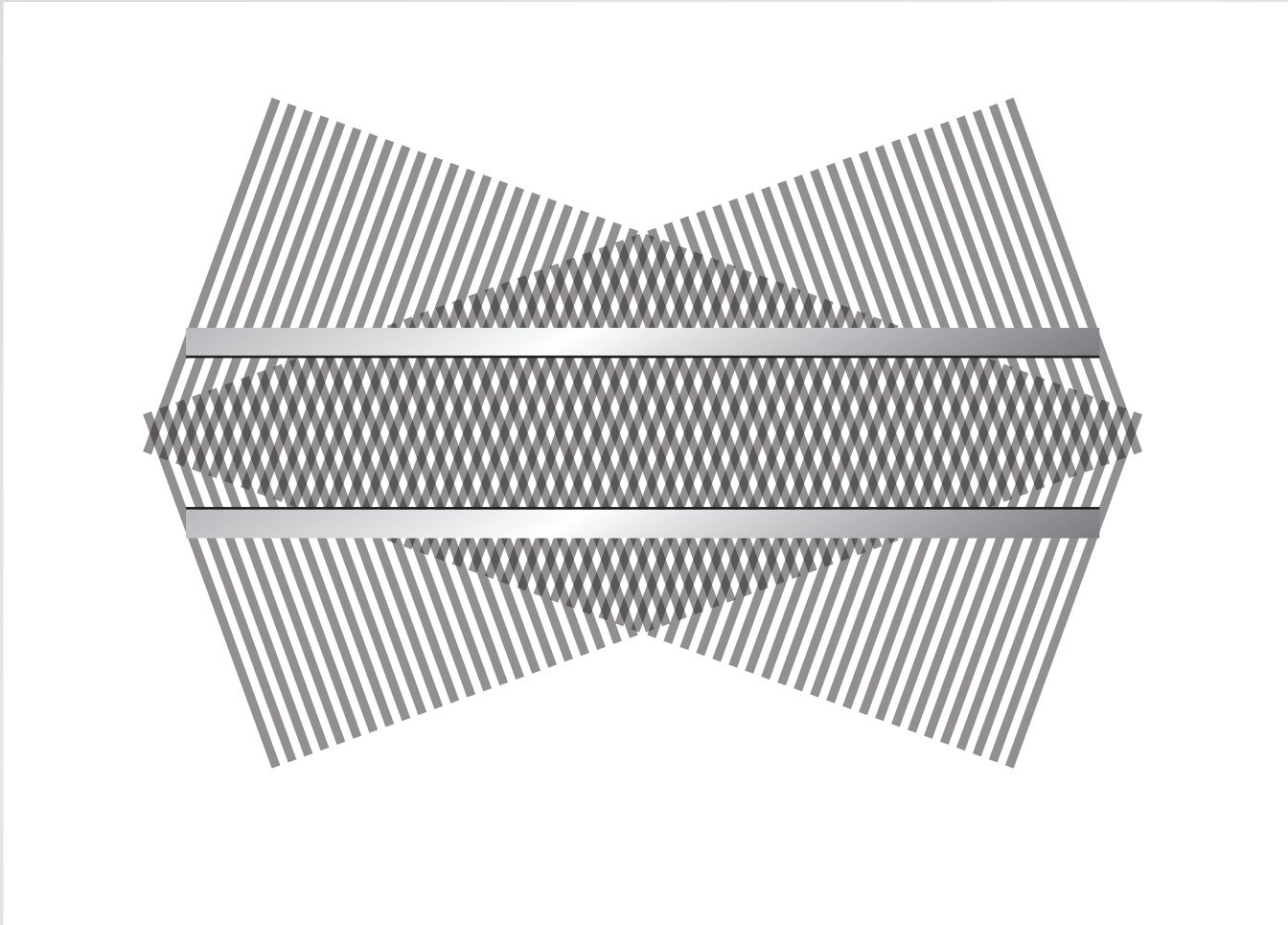

Waveguiding

transverse standing wave, traveling along axis

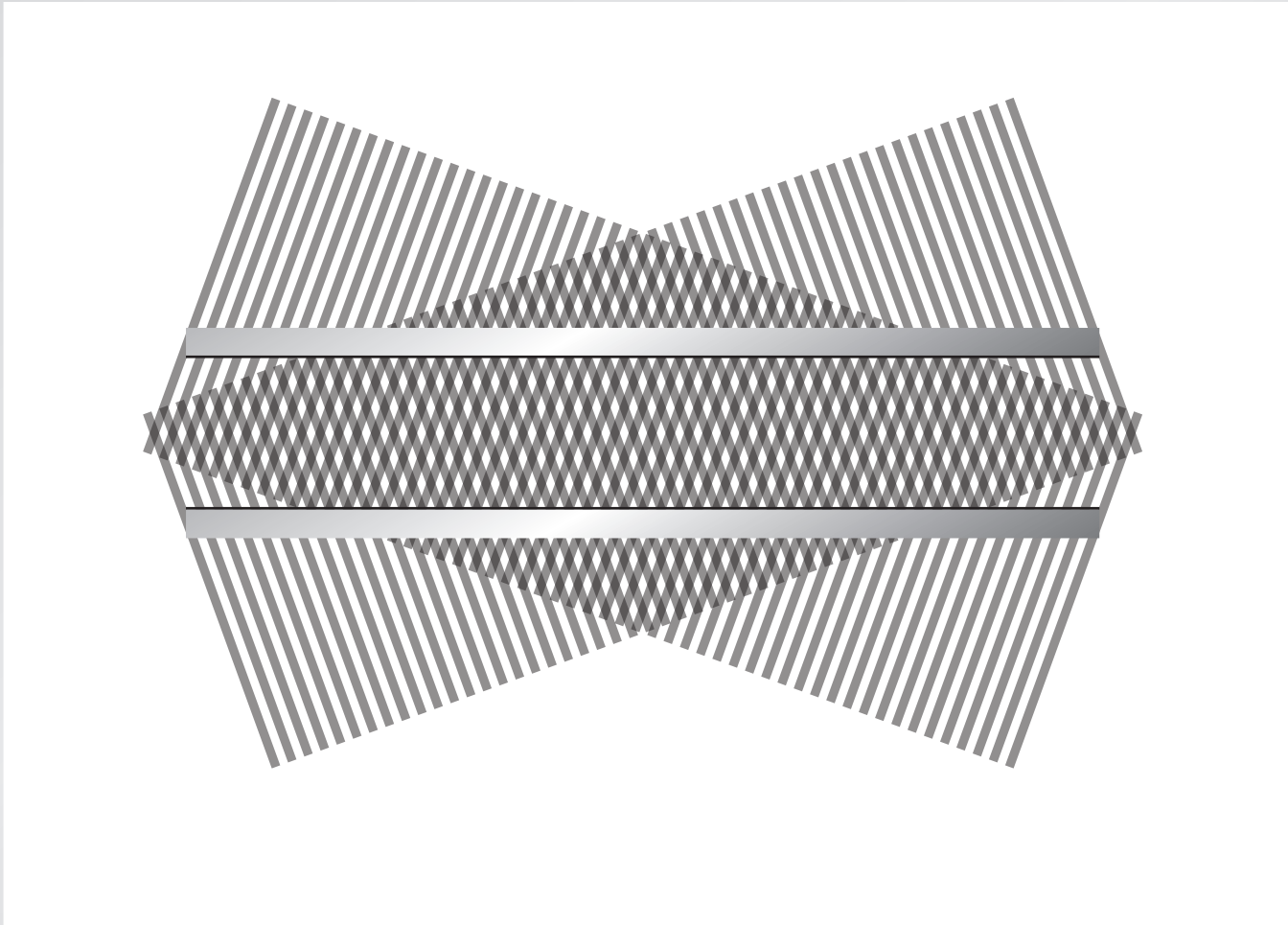

Waveguiding

transverse standing wave, traveling along axis

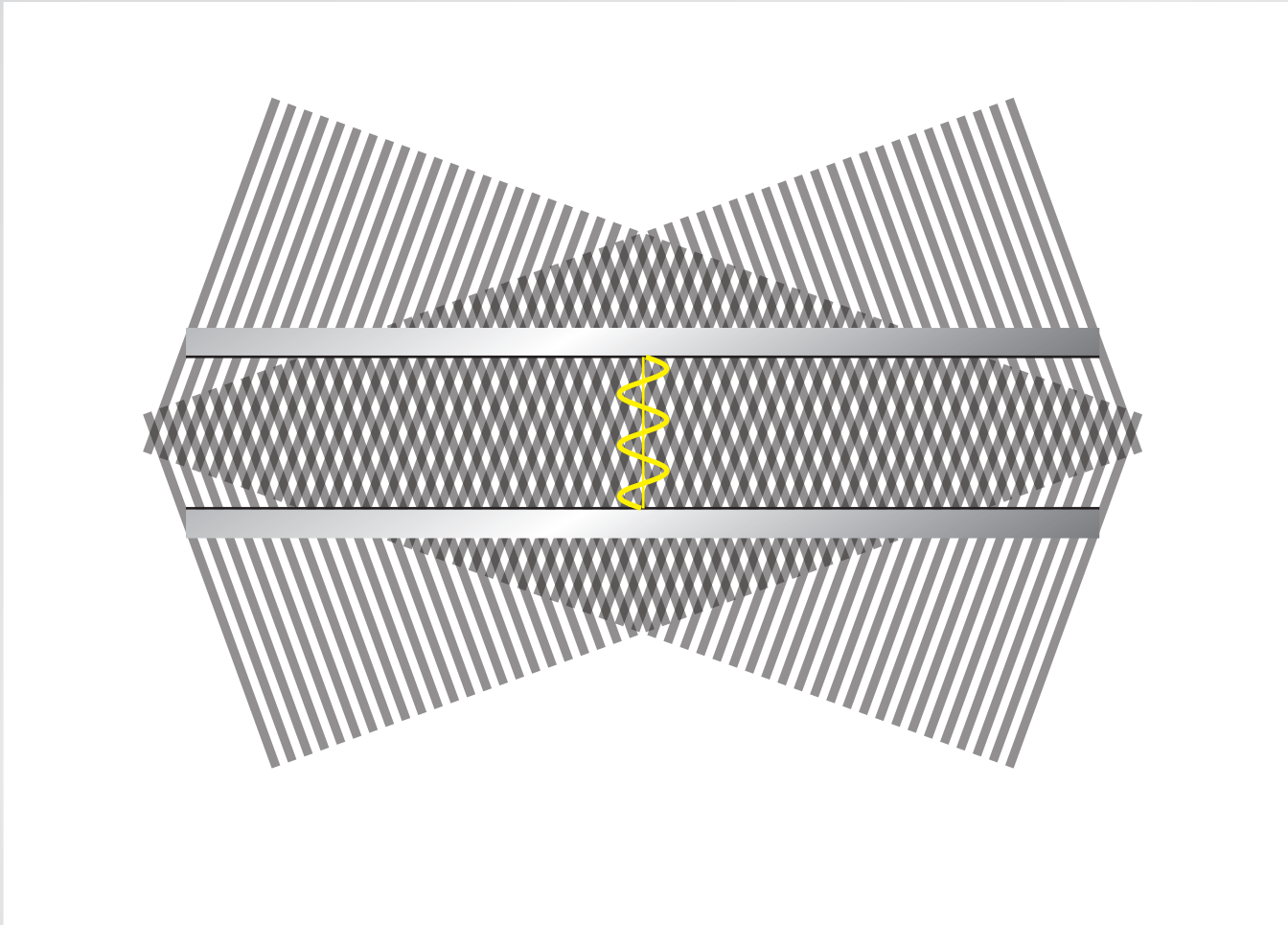

Waveguiding

change angle of incident waves...

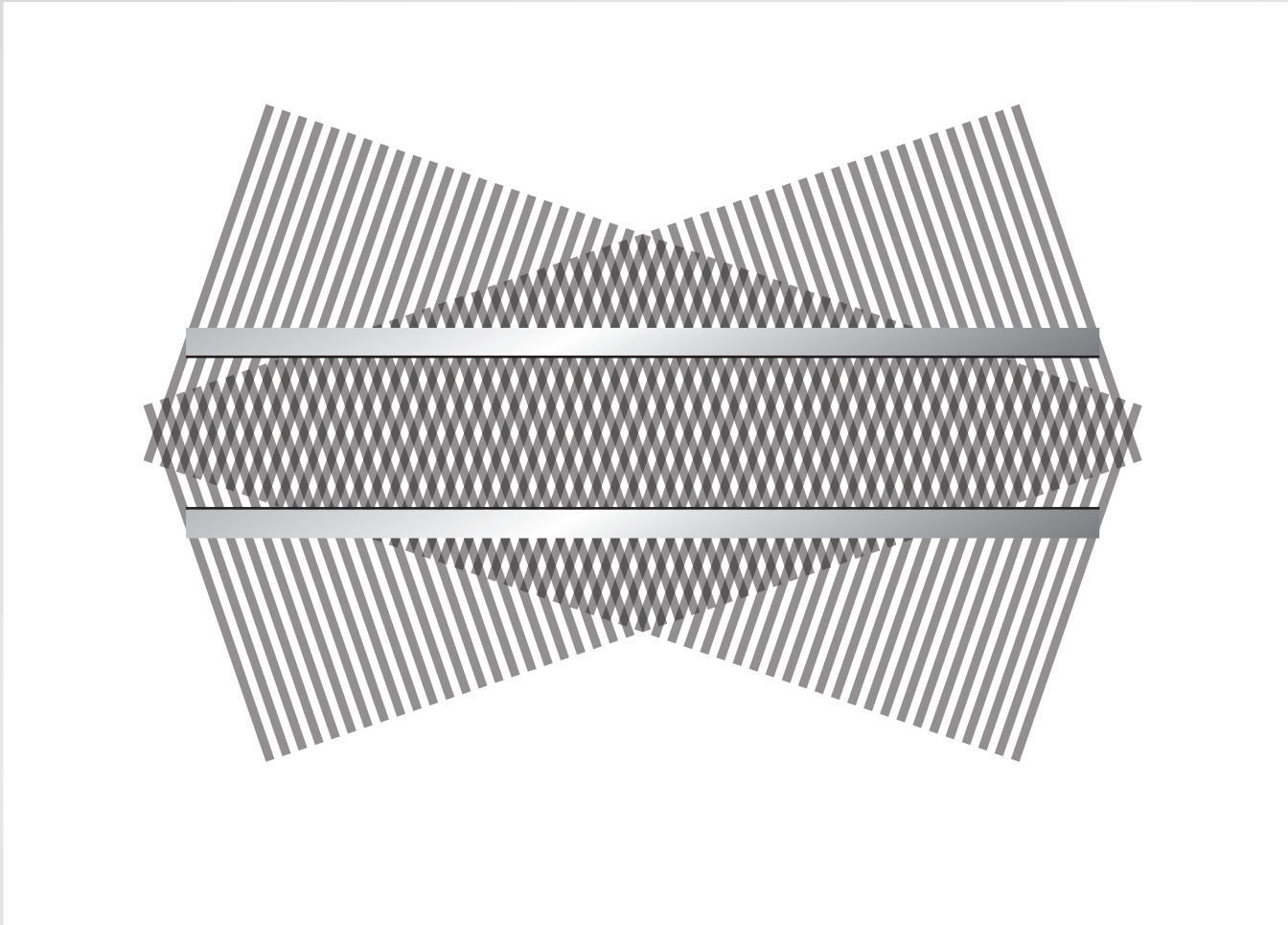

Waveguiding

change angle of incident waves...

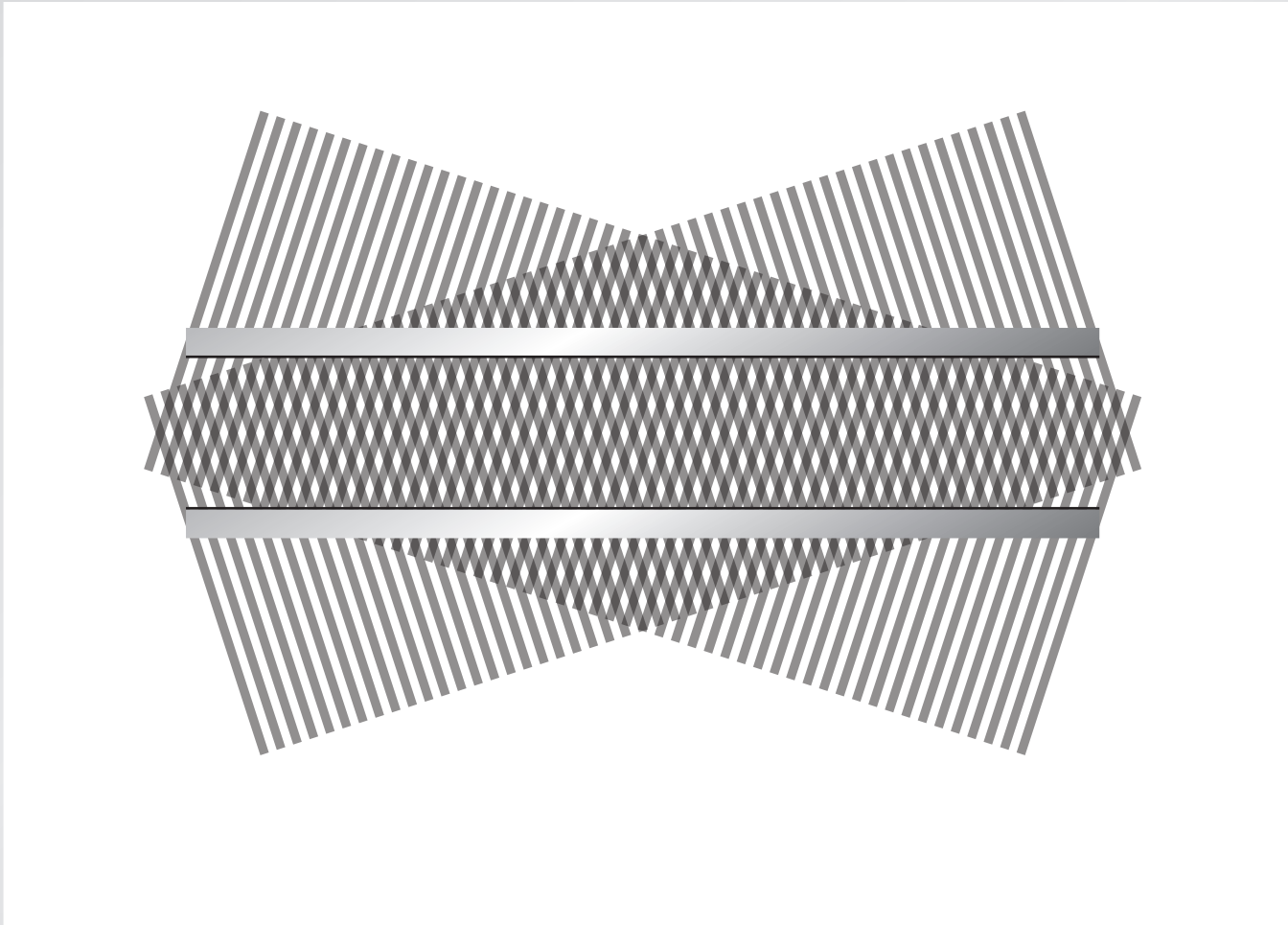

Waveguiding

change angle of incident waves...

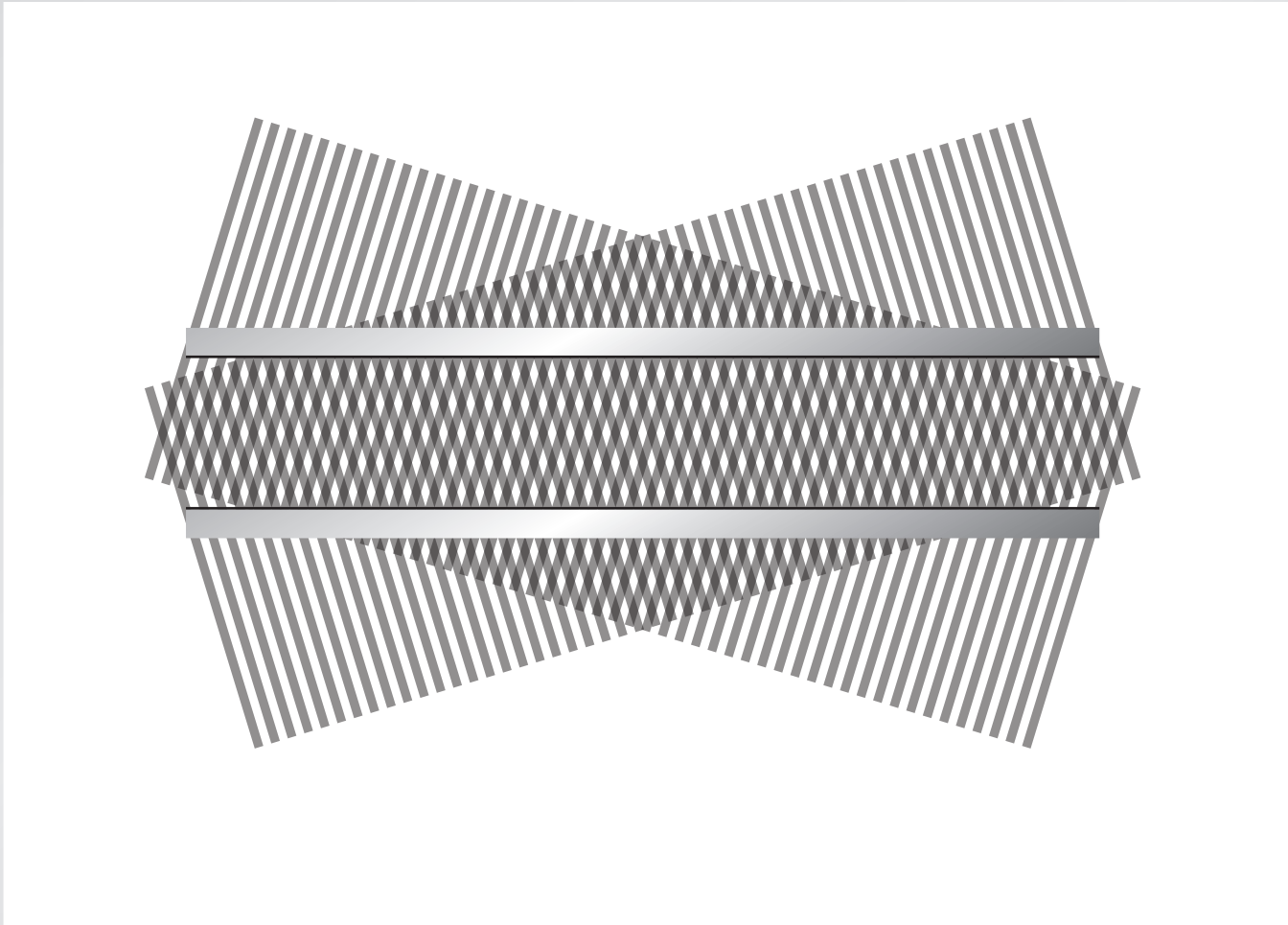

Waveguiding

change angle of incident waves...

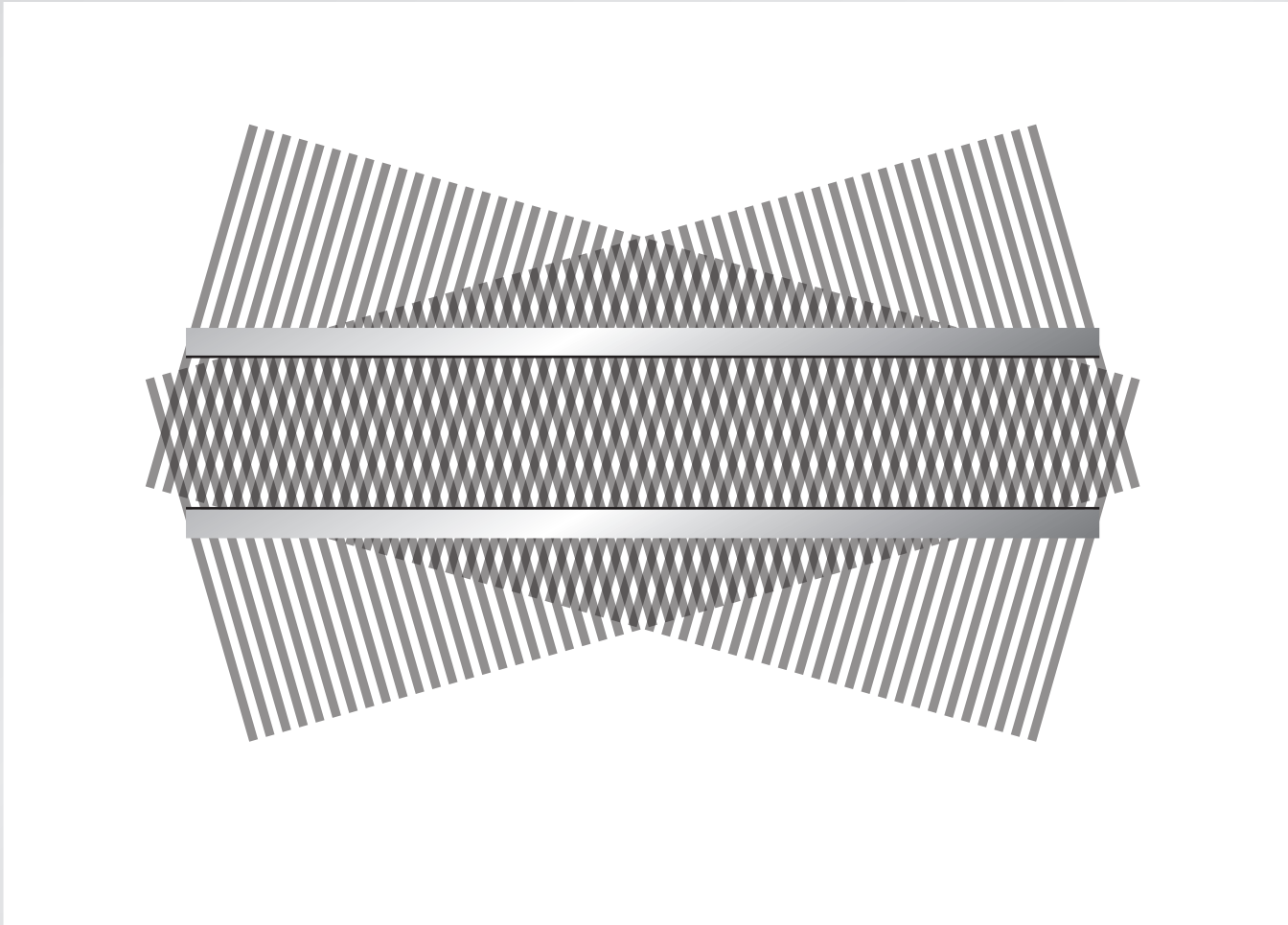

Waveguiding

change angle of incident waves...

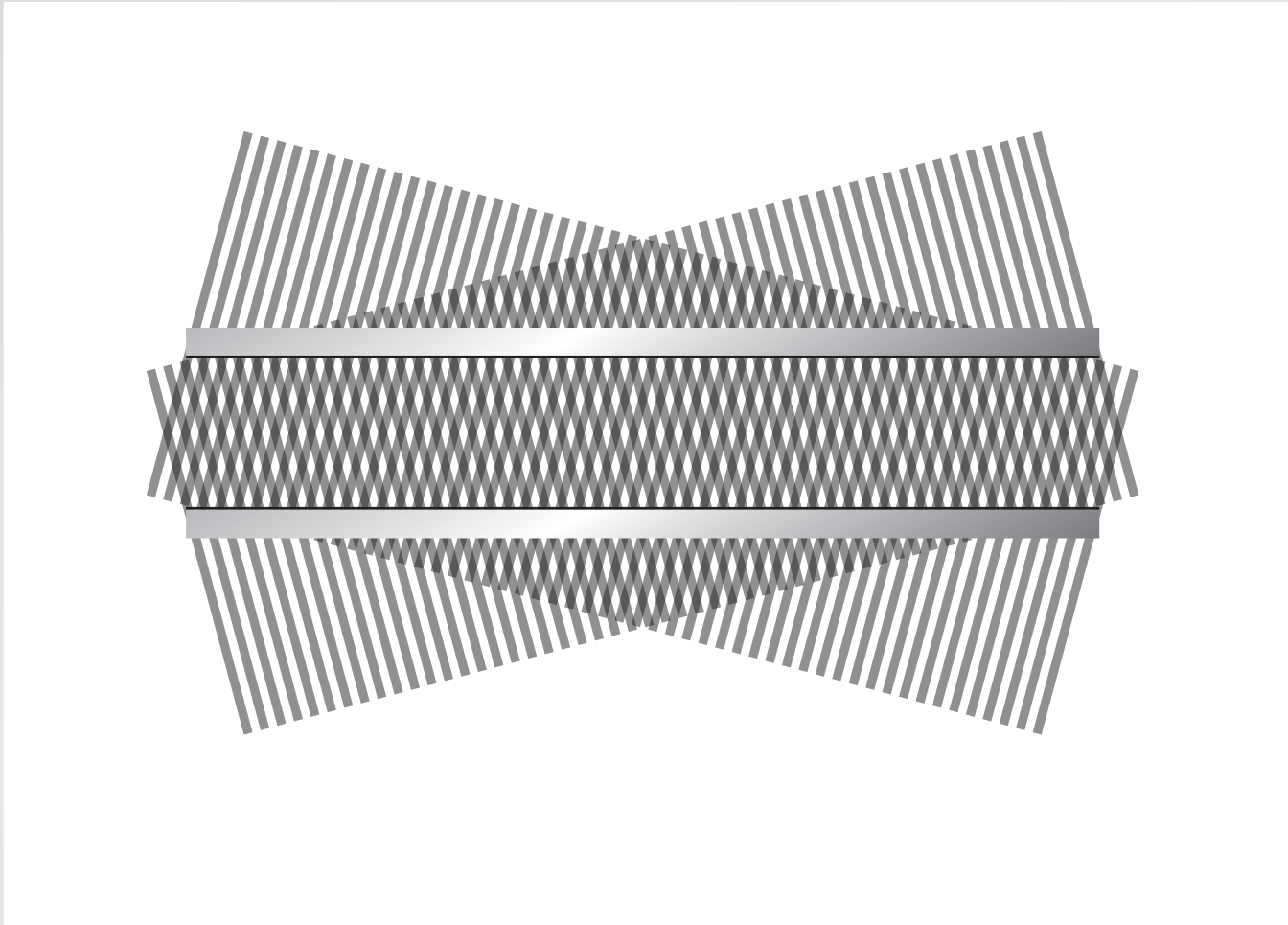

Waveguiding

change angle of incident waves...

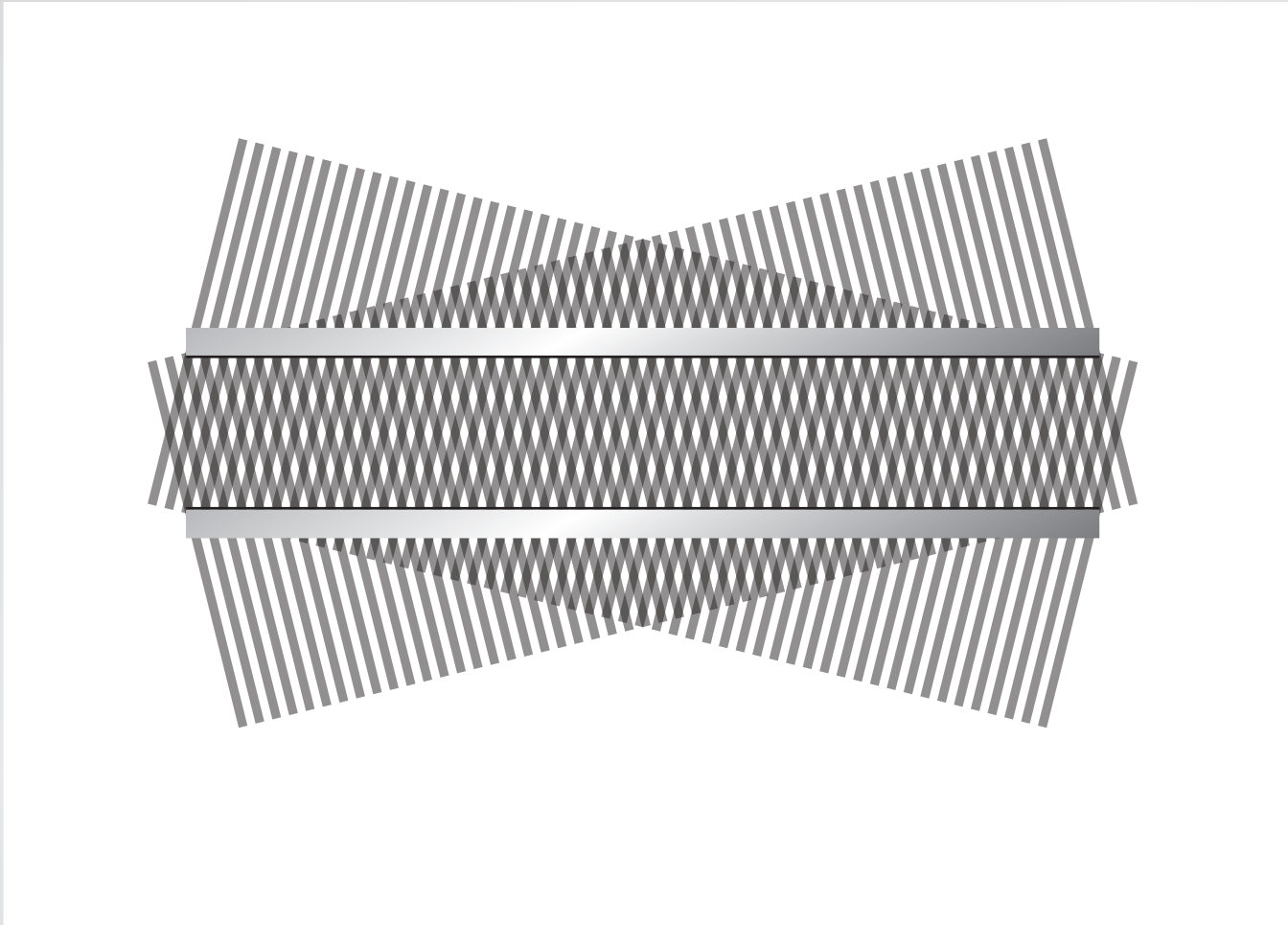

Waveguiding

change angle of incident waves...

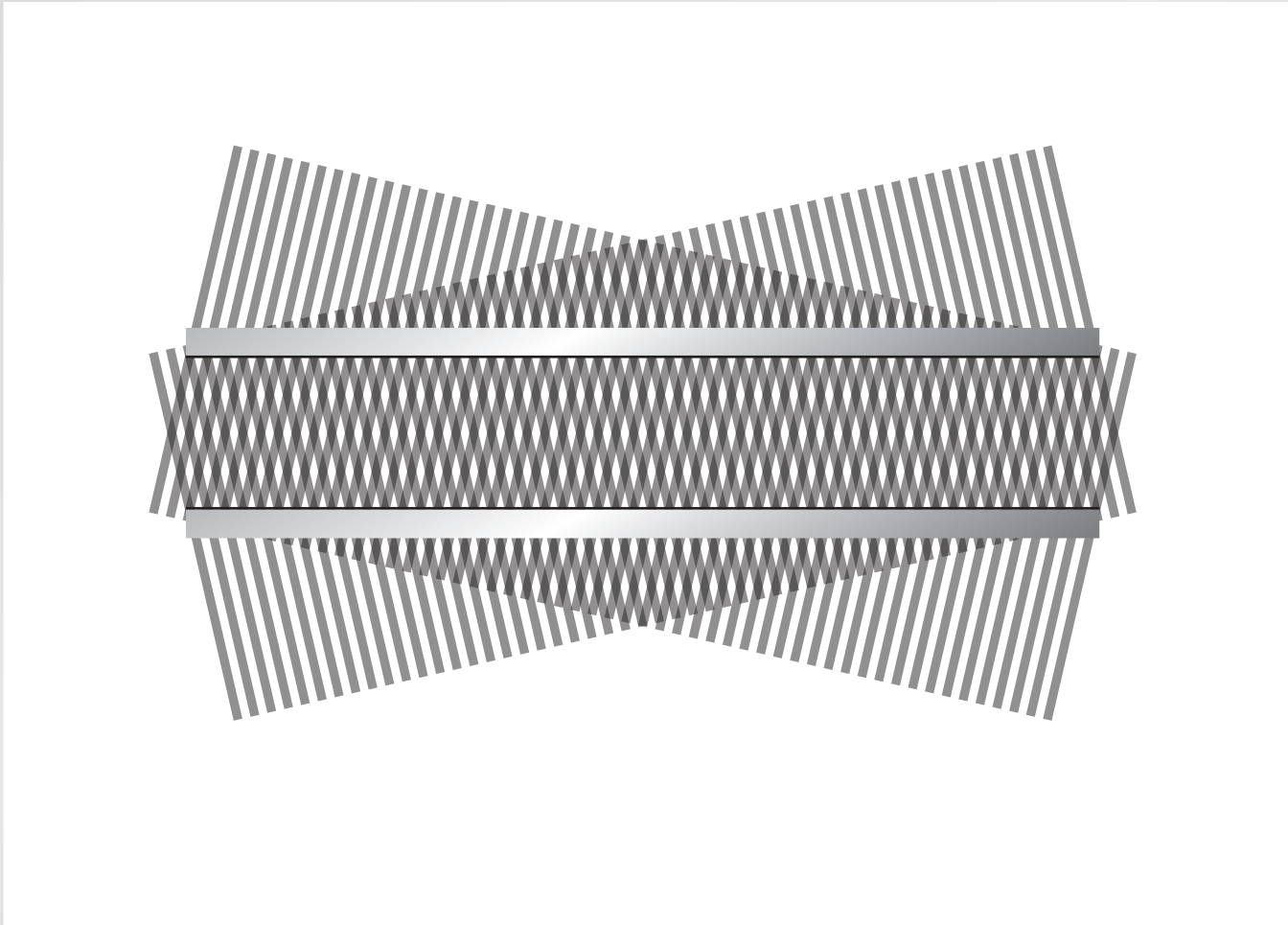

Waveguiding

change angle of incident waves...

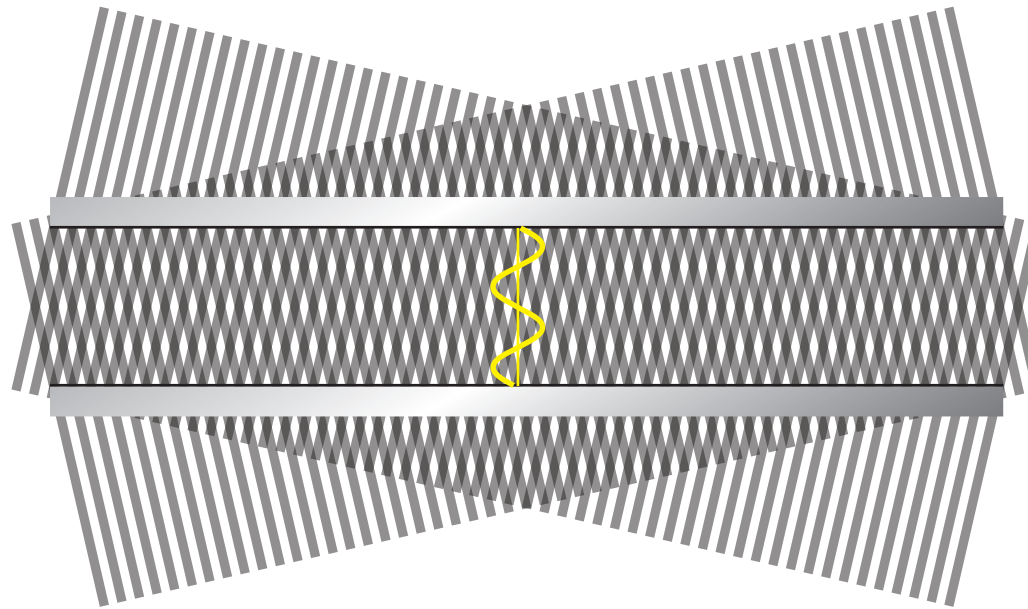

Waveguiding

change angle of incident waves...

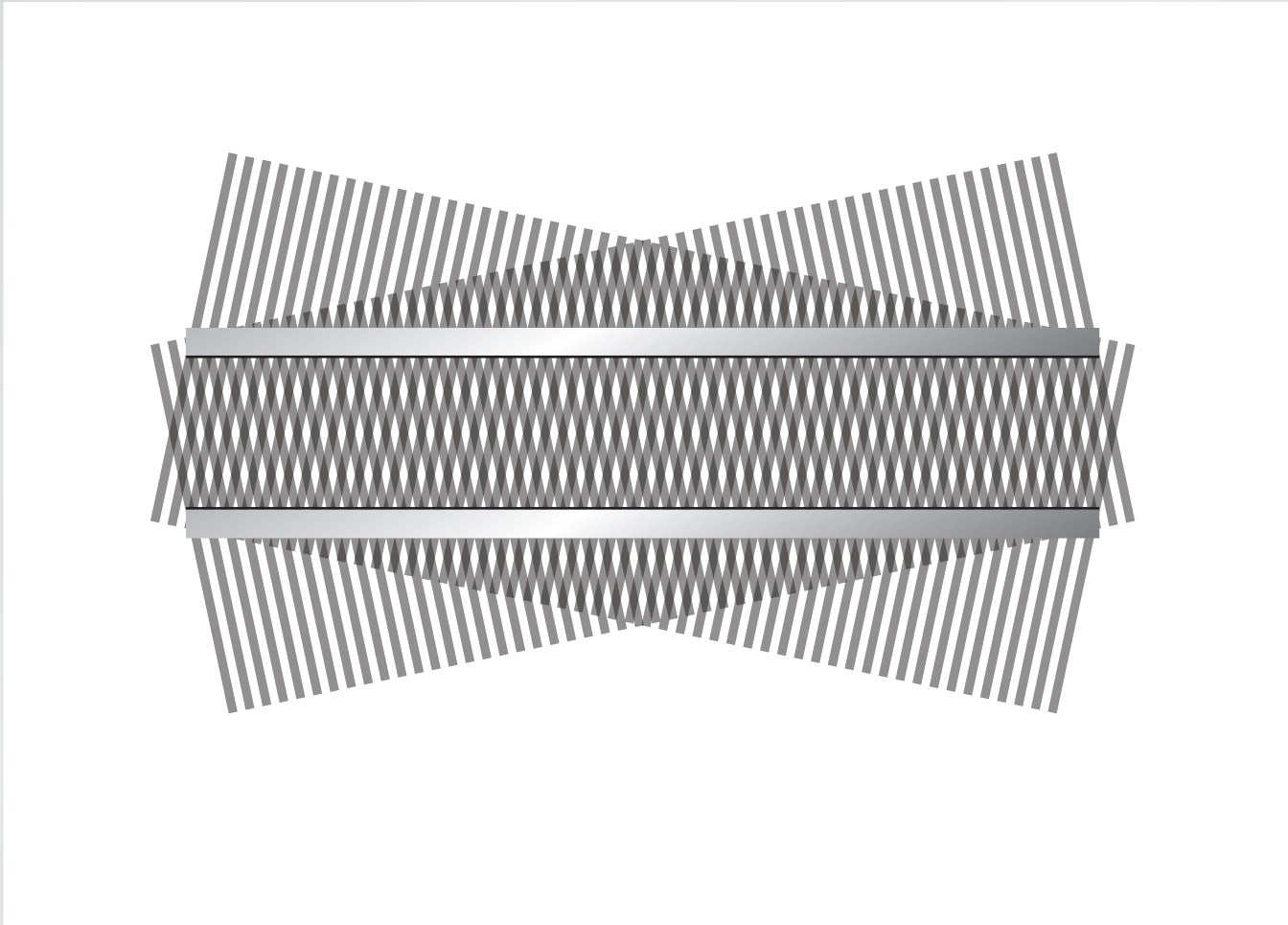

Waveguiding

change angle of incident waves...

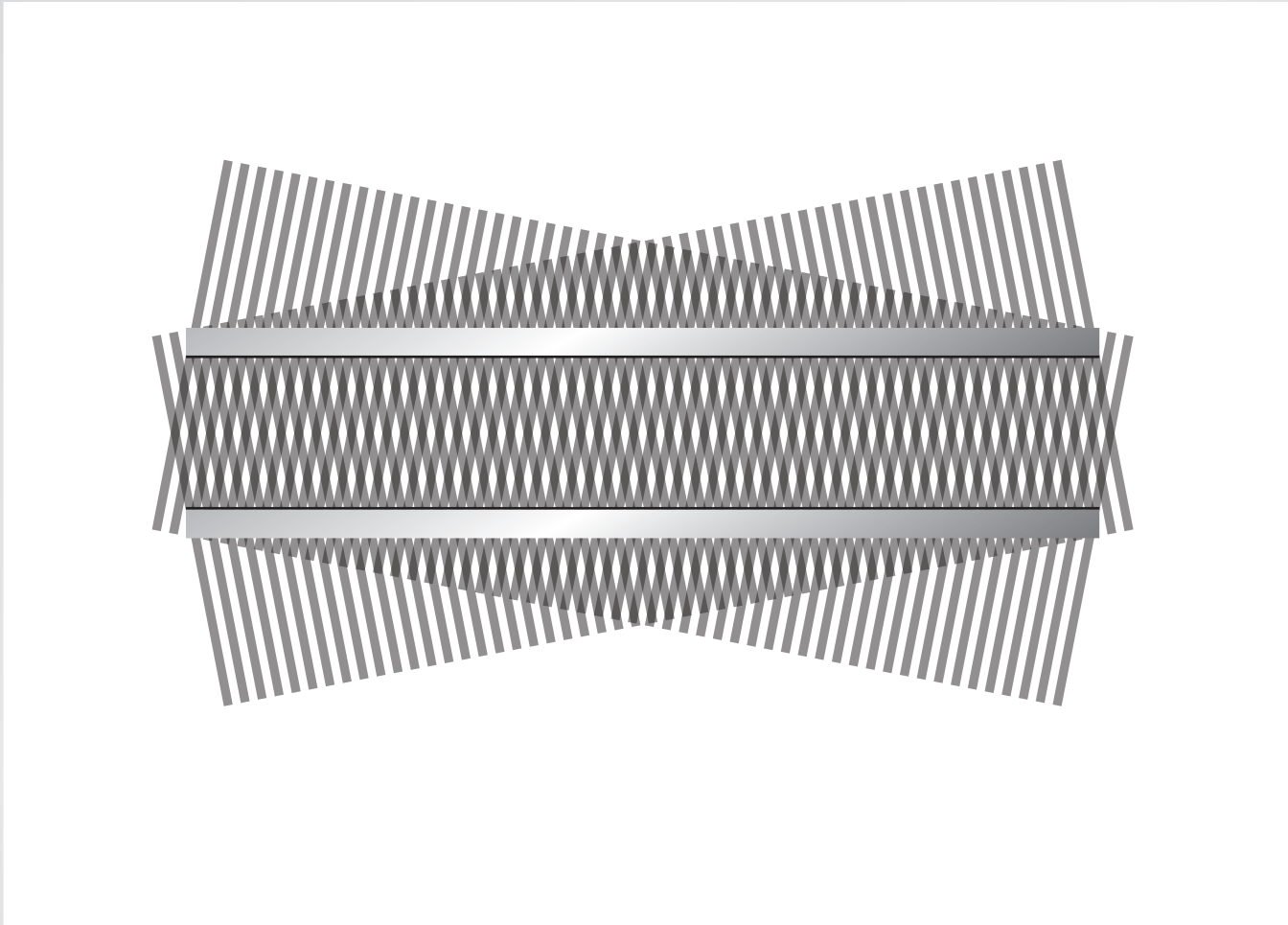

Waveguiding

change angle of incident waves...

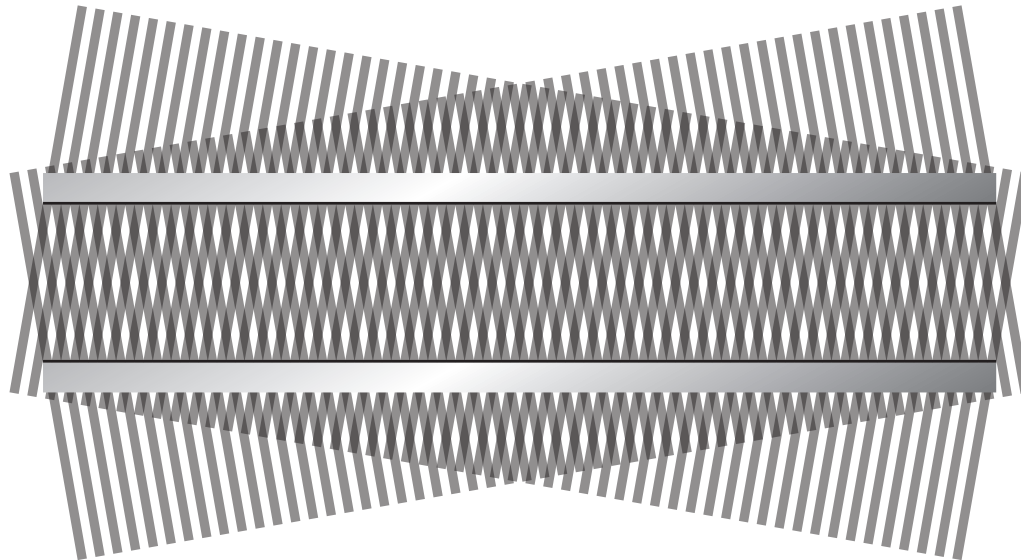

Waveguiding

change angle of incident waves...

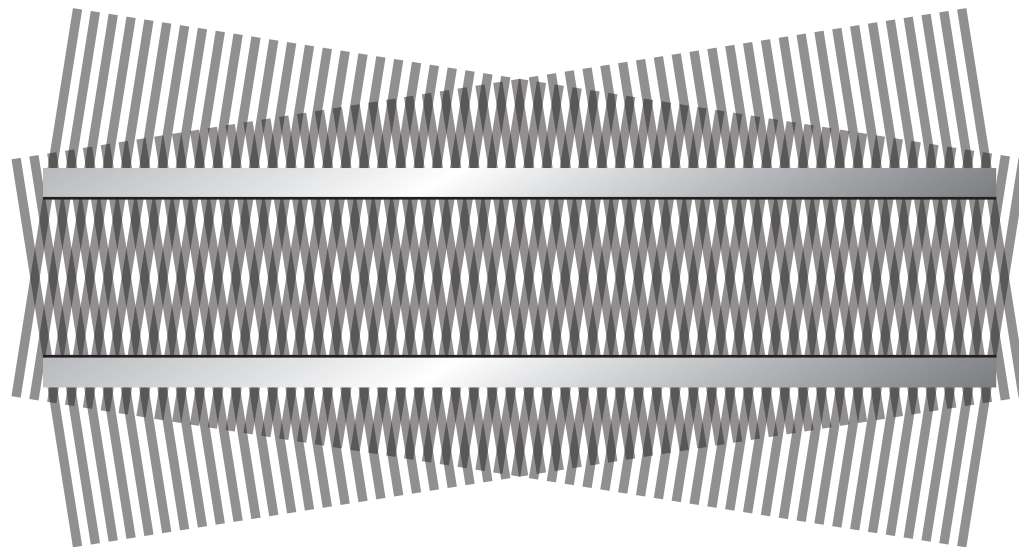

Waveguiding

change angle of incident waves...

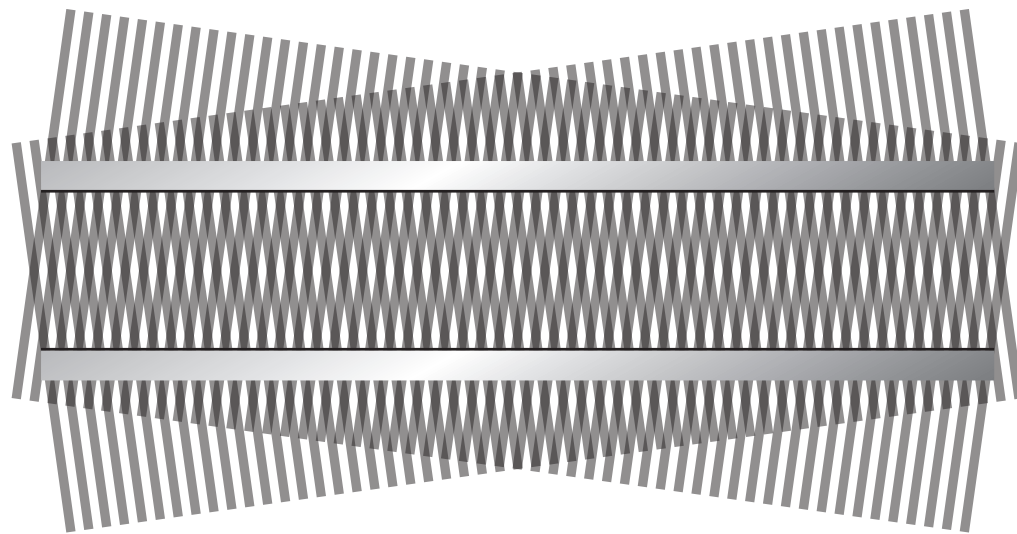

Waveguiding

change angle of incident waves...

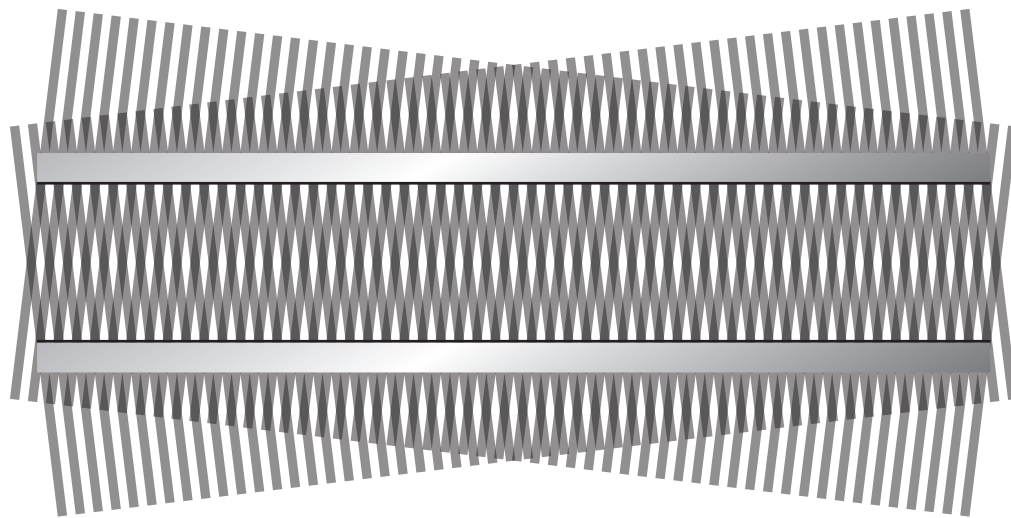

Waveguiding

change angle of incident waves...

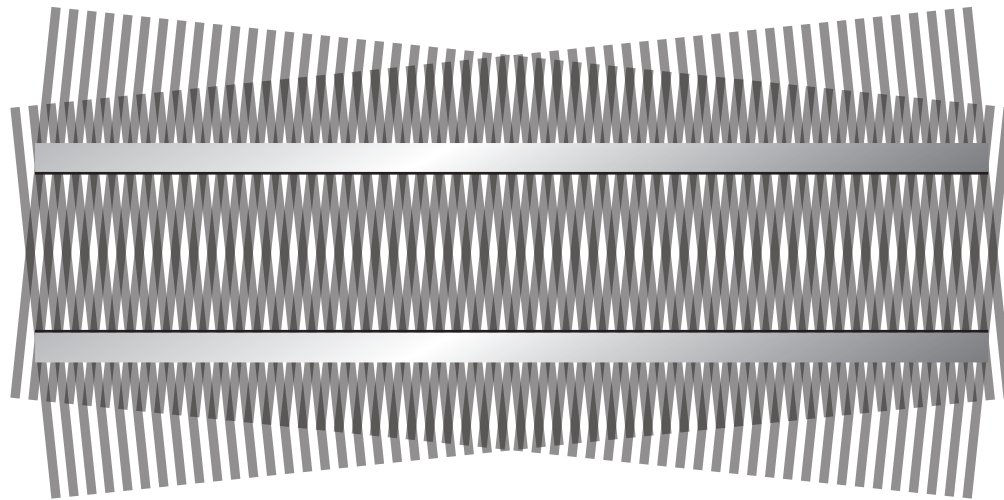

Waveguiding

change angle of incident waves...

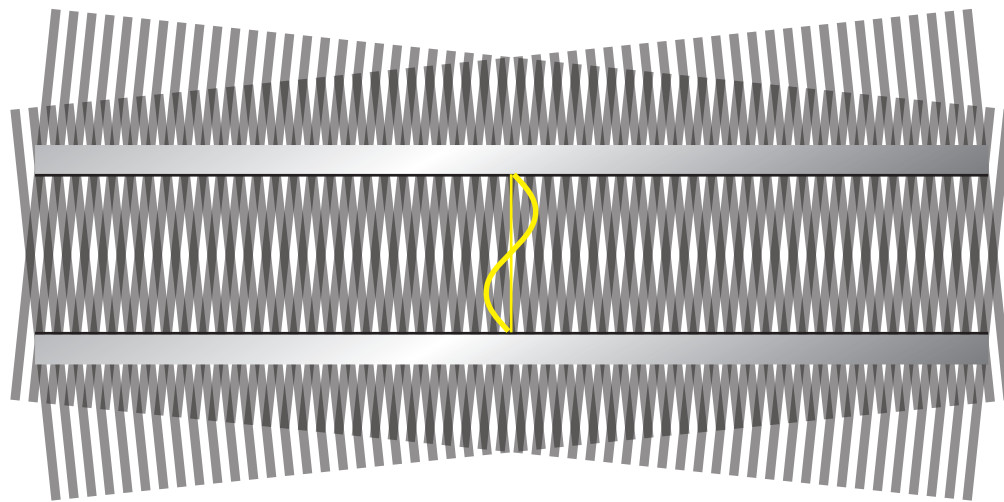

Waveguiding

change angle of incident waves...

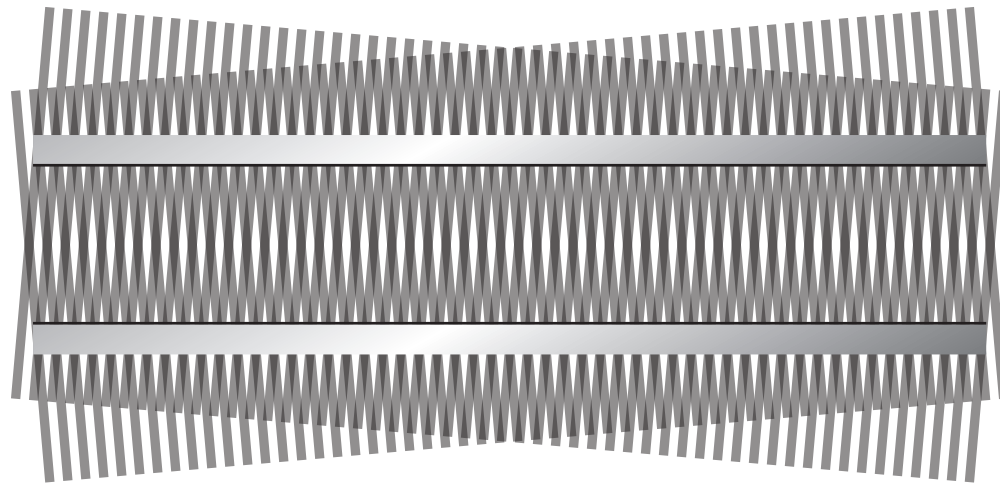

Waveguiding

change angle of incident waves...

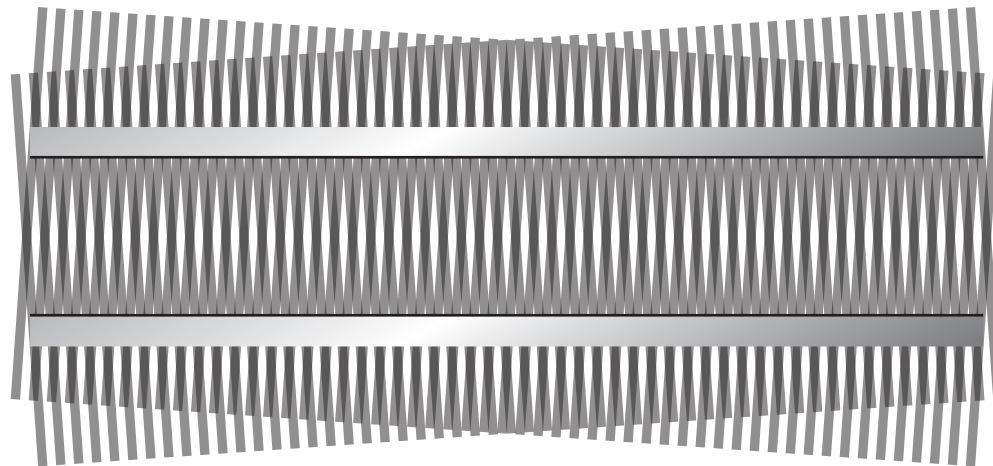

Waveguiding

boundary conditions only satisfied for certain θ

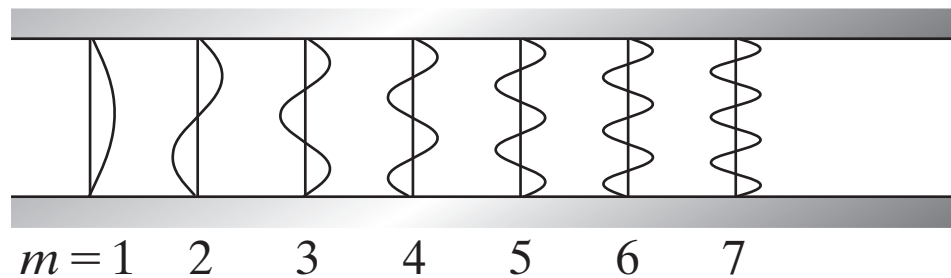

standing wave in y -direction, traveling in z -direction

Waveguiding

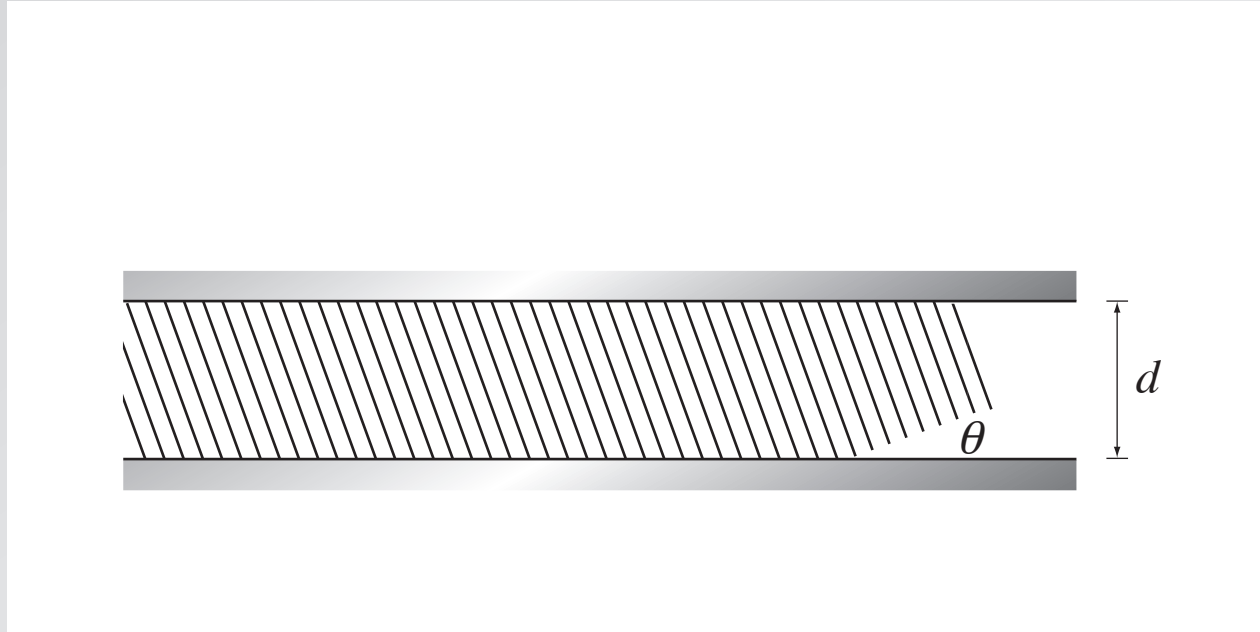

consider wave incident at angle θ

Waveguiding

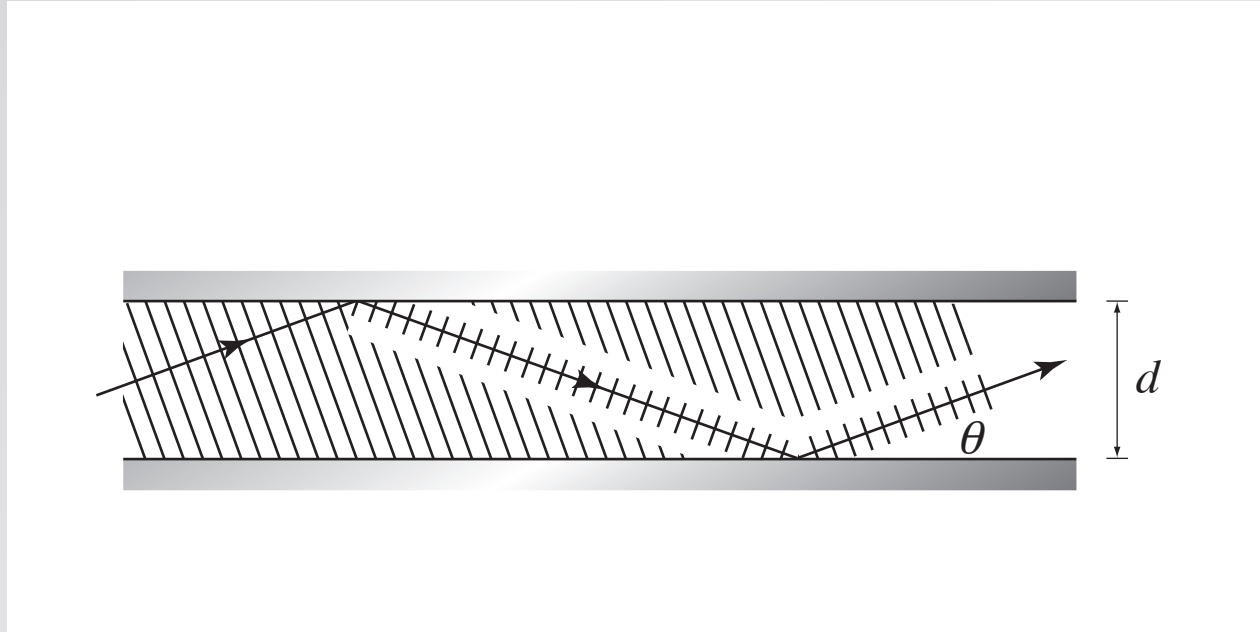

twice-reflected wave

Waveguiding

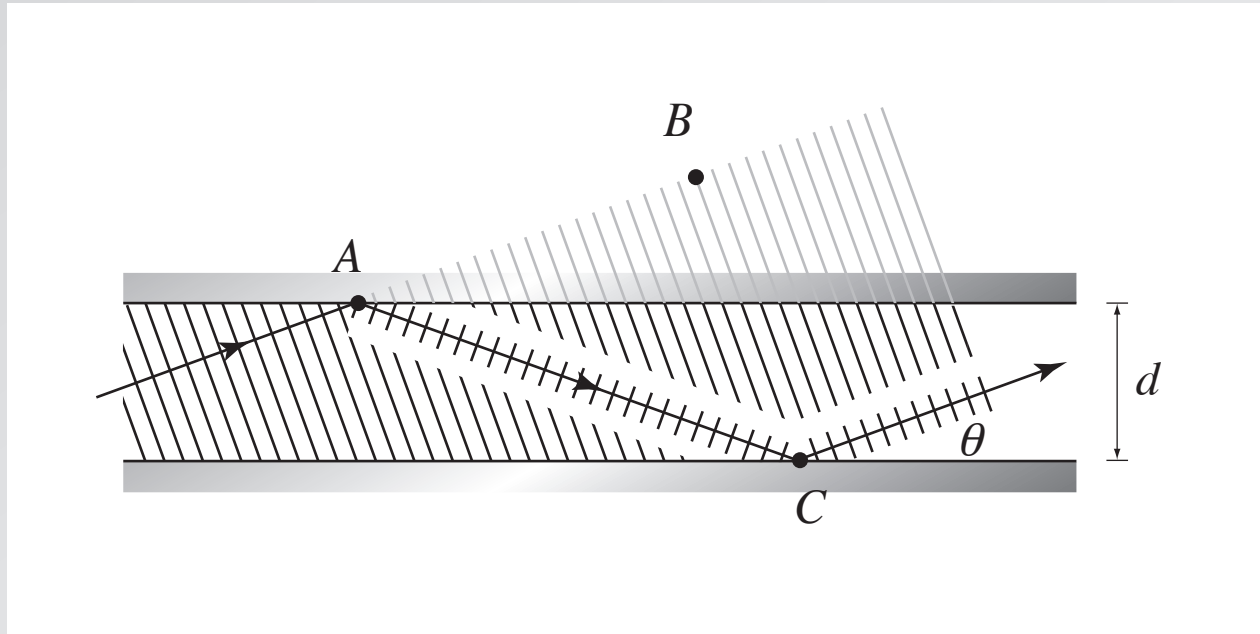

self consistency:

$$AC - AB = 2d \sin\theta = m\lambda \quad (m = 1, 2, \dots)$$

Waveguiding

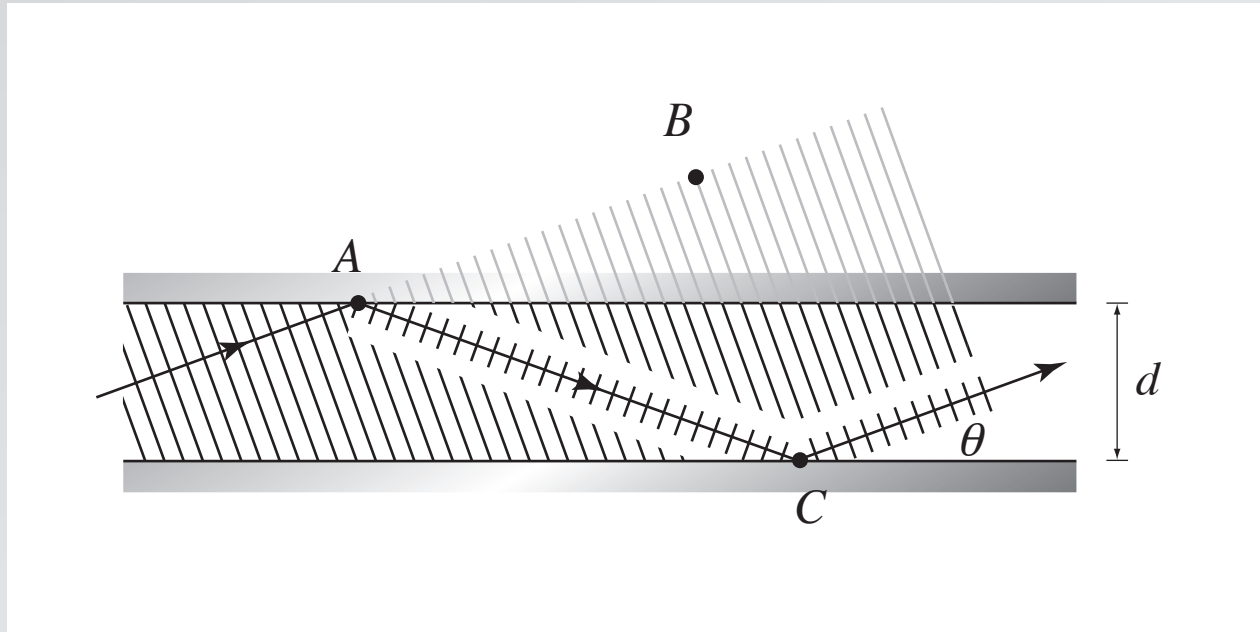

self consistency:

$$AC - AB = 2d \sin\theta = m\lambda \quad (m = 1, 2, \dots)$$

so:

$$\sin\theta_m = m \frac{\lambda}{2d}$$

Waveguiding

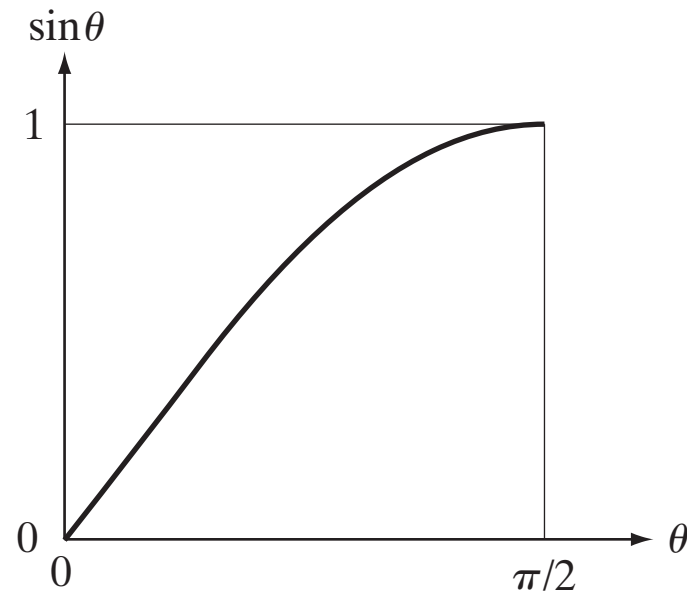

self consistency:

$$AC - AB = 2d \sin \theta = m\lambda \quad (m = 1, 2, \dots)$$

so:

$$\sin \theta_m = m \frac{\lambda}{2d}$$

Waveguiding

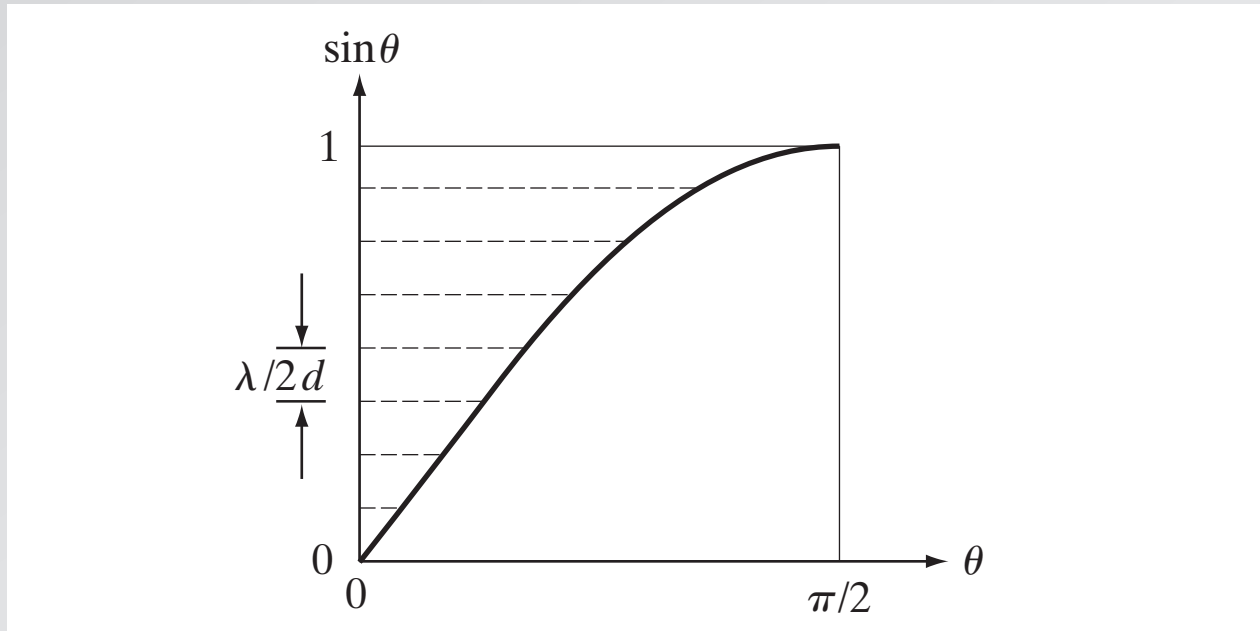

self consistency:

$$AC - AB = 2d \sin \theta = m\lambda \quad (m = 1, 2, \dots)$$

so:

$$\sin \theta_m = m \frac{\lambda}{2d}$$

Waveguiding

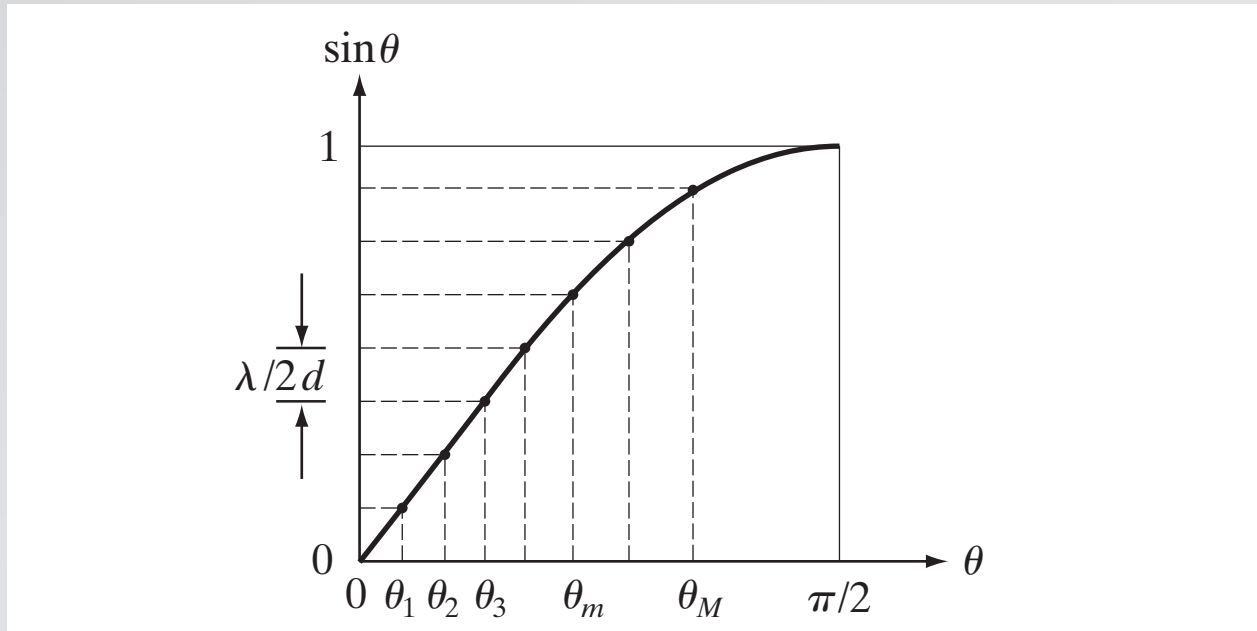

self consistency:

$$AC - AB = 2d \sin \theta = m\lambda \quad (m = 1, 2, \dots)$$

so:

$$\sin \theta_m = m \frac{\lambda}{2d}$$

Waveguiding

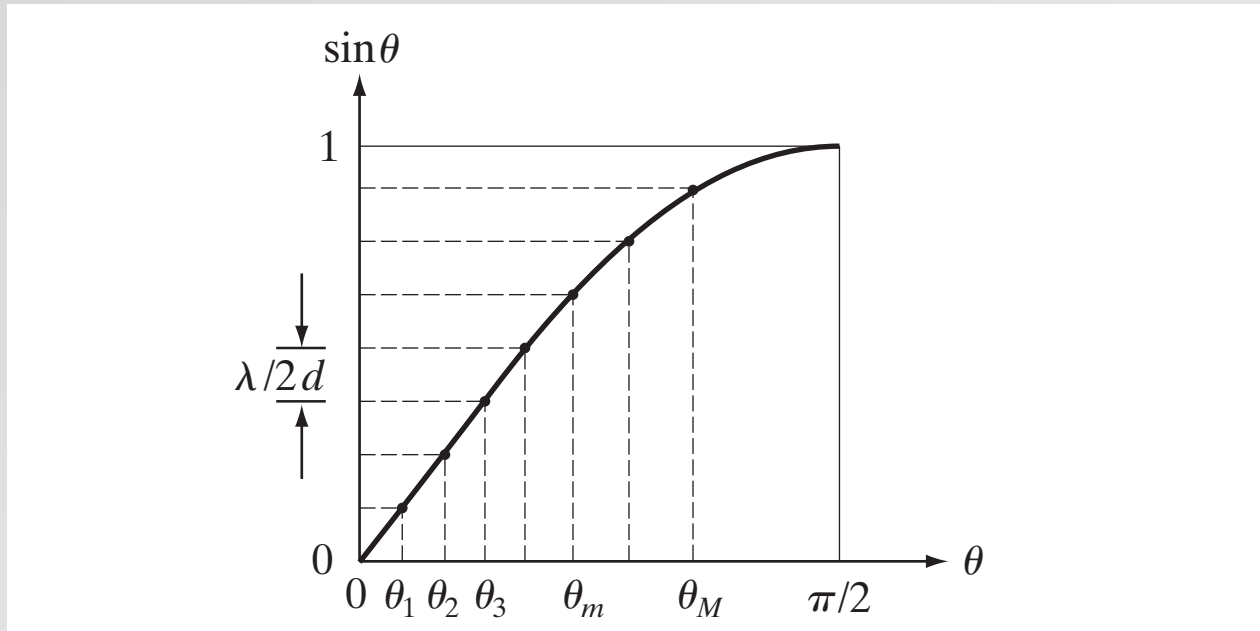

number of modes:

$$M = \frac{2d}{\lambda}$$

Waveguiding



now consider a planar dielectric waveguide

Waveguiding

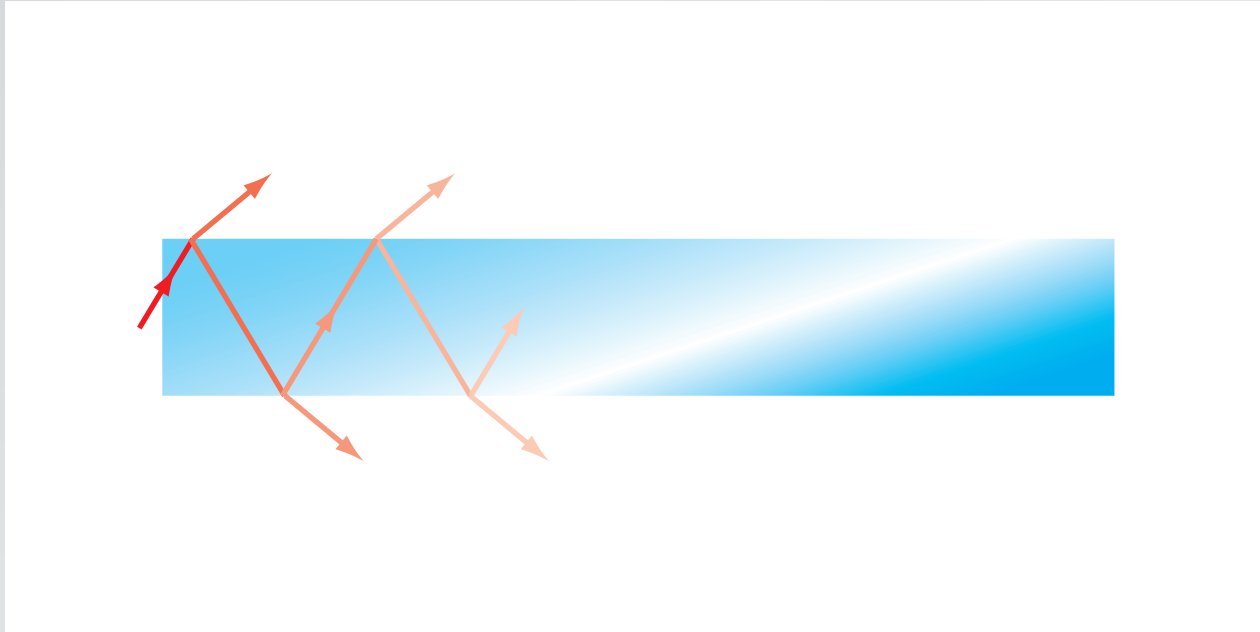

rays incident at angle $\theta > \pi/2 - \theta_c$ are unguided

Waveguiding

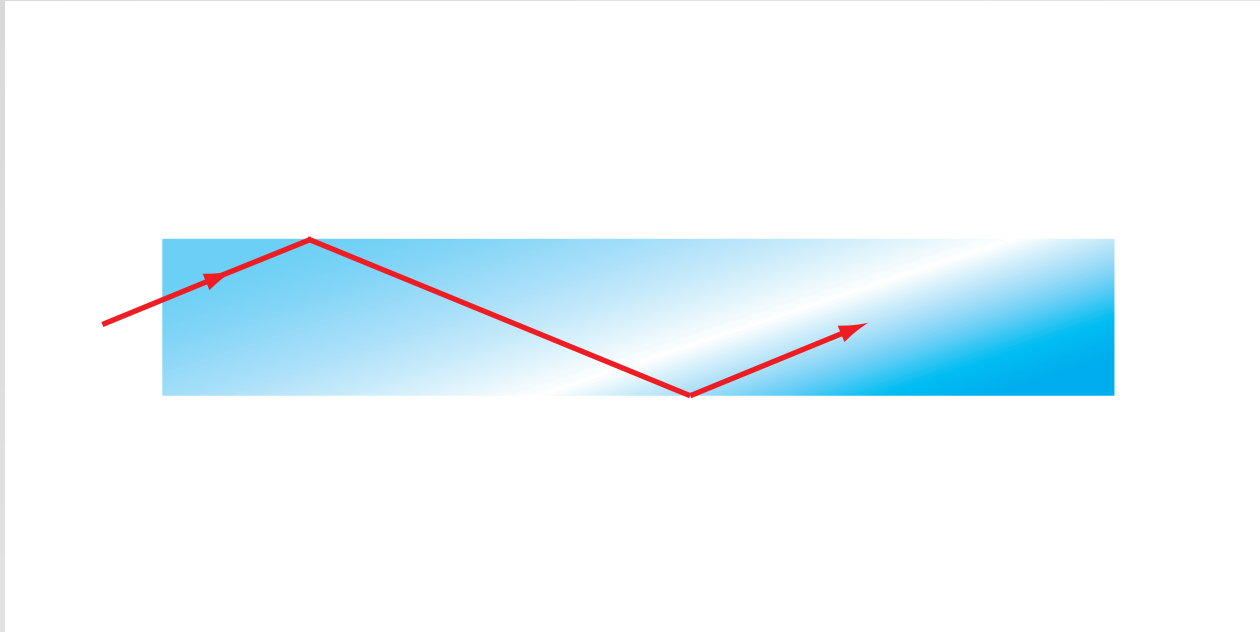

rays incident at angle $\theta < \pi/2 - \theta_c$ are guided

Waveguiding

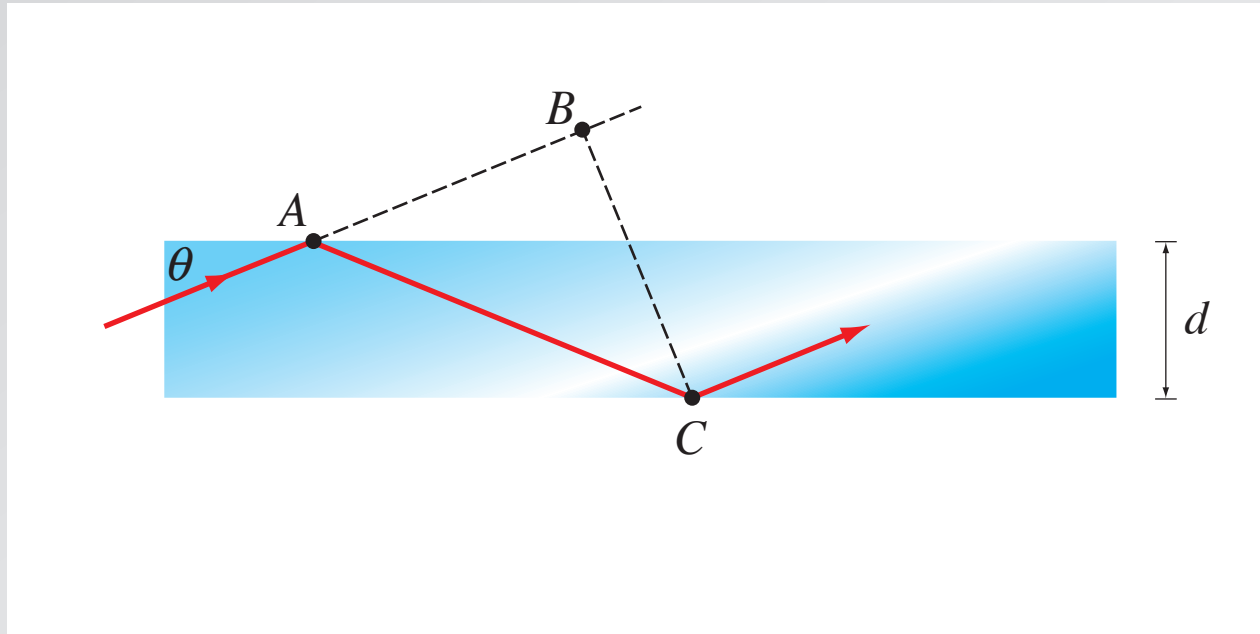

rays incident at angle $\theta < \pi/2 - \theta_c$ are guided

Waveguiding

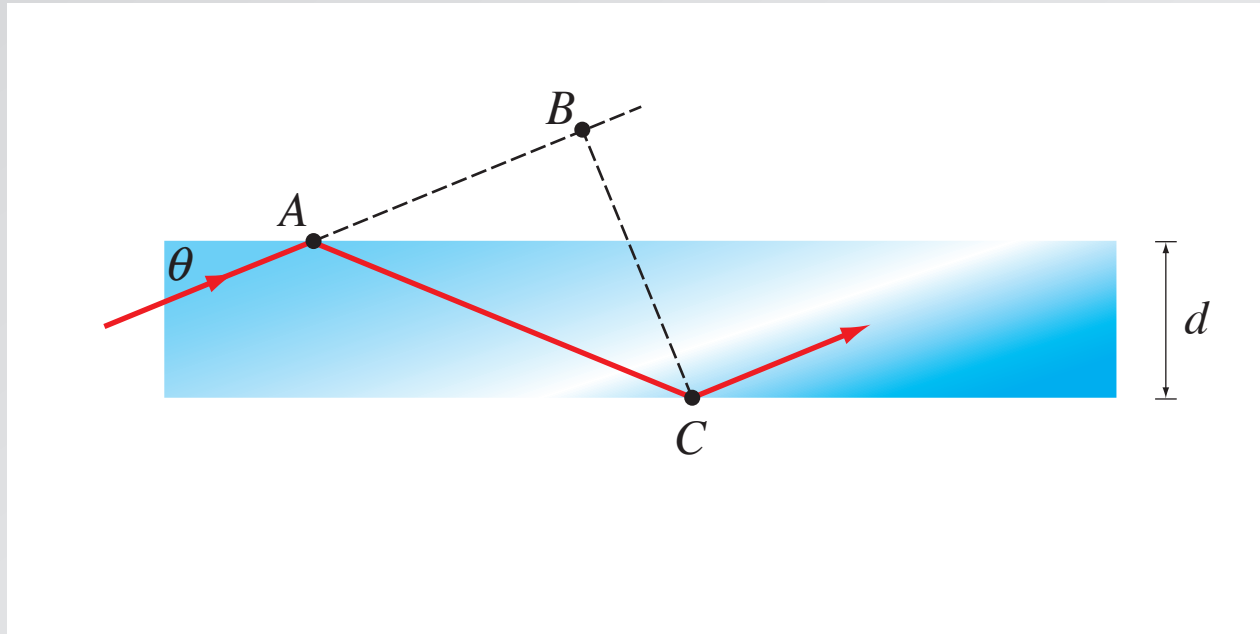

self consistency:

$$AC - AB = 2d \sin \theta - \frac{\varphi_r}{\pi} \lambda = m \lambda \quad (m = 0, 1, 2 \dots)$$

Waveguiding

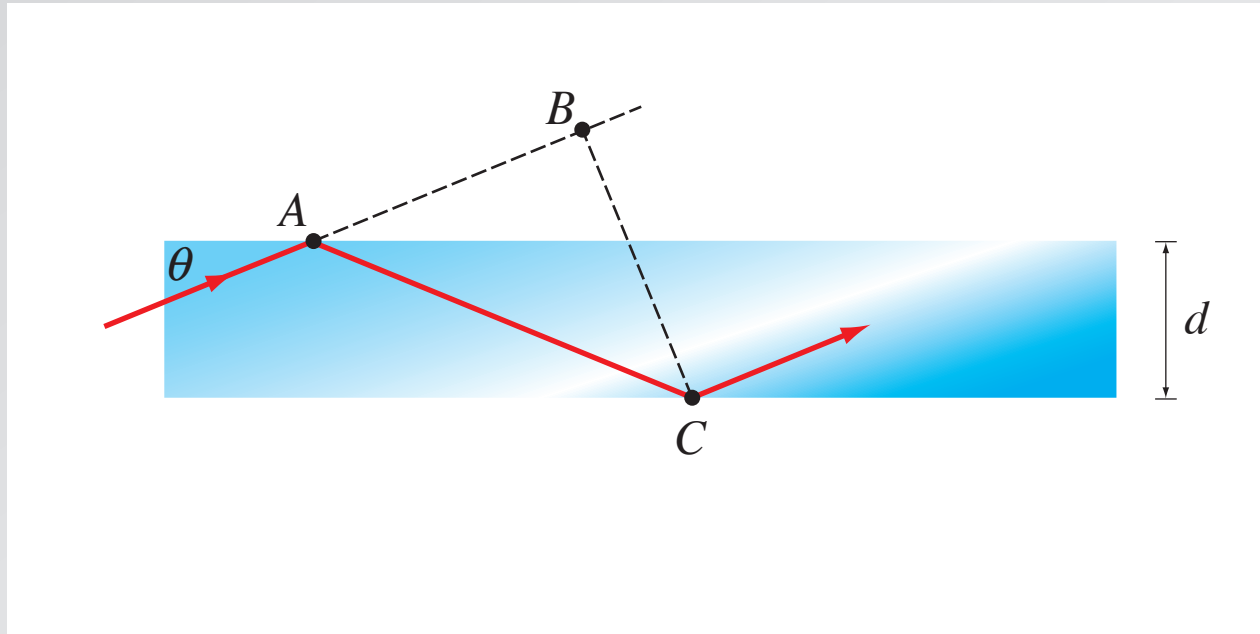

self consistency:

$$AC - AB = 2d \sin\theta - \frac{\varphi_r}{\pi} \lambda = m\lambda \quad (m = 0, 1, 2\dots)$$

SO:

$$\tan\left(\frac{\pi d}{\lambda} \sin\theta - m\frac{\pi}{2}\right) = \left(\frac{\sin^2(\pi/2 - \theta_c)}{\sin^2\theta} - 1\right)^{1/2}$$

Waveguiding

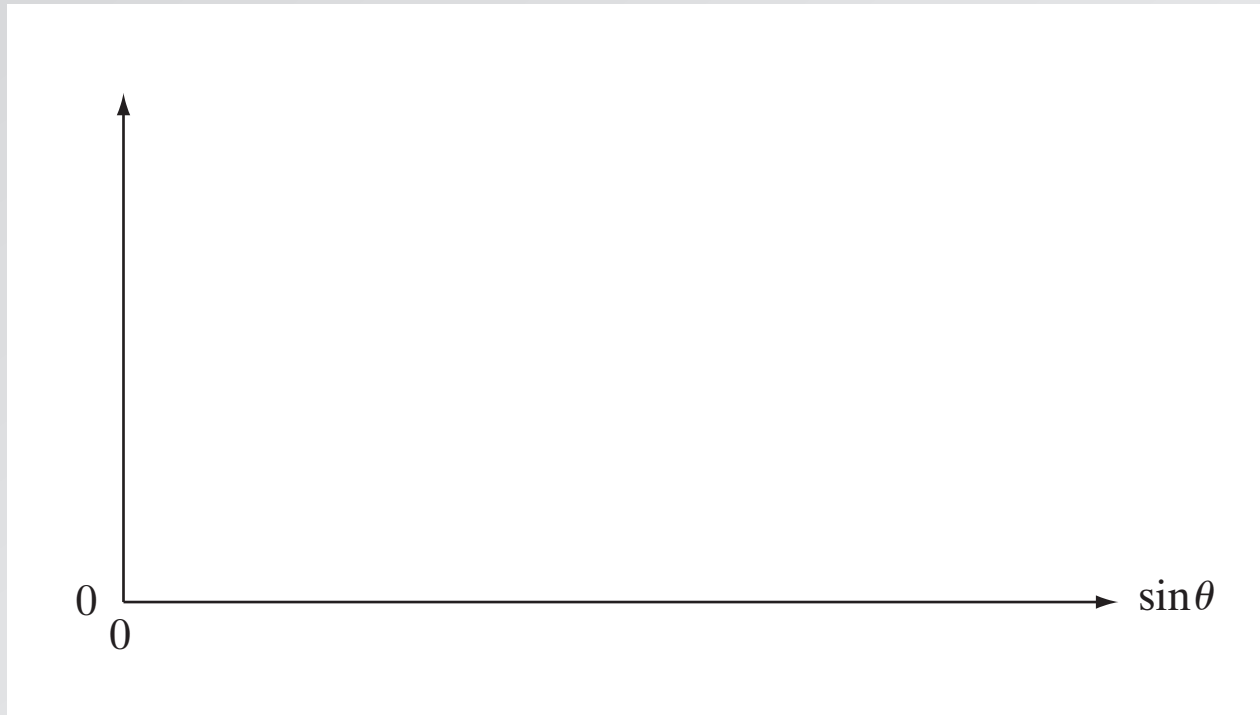

self consistency:

$$AC - AB = 2d \sin \theta - \frac{\varphi_r}{\pi} \lambda = m \lambda \quad (m = 0, 1, 2 \dots)$$

SO:

$$\tan \left(\frac{\pi d}{\lambda} \sin \theta - m \frac{\pi}{2} \right) = \left(\frac{\sin^2(\pi/2 - \theta_c)}{\sin^2 \theta} - 1 \right)^{1/2}$$

Waveguiding

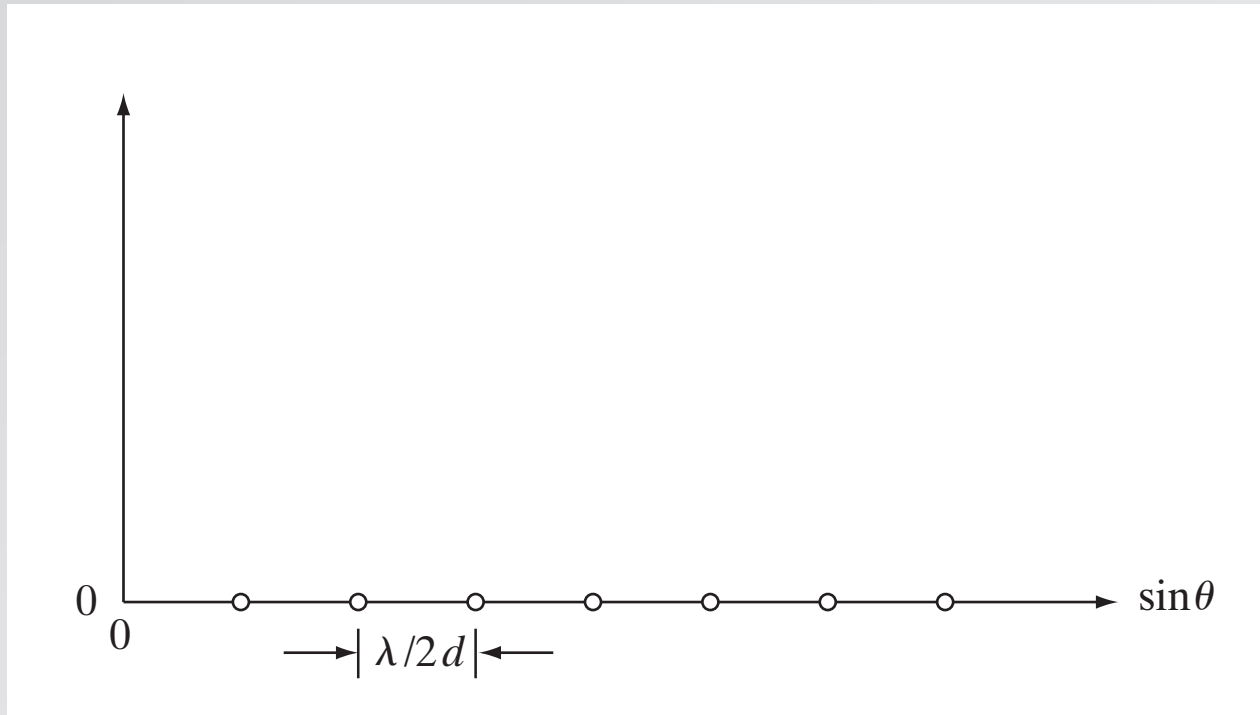

self consistency:

$$AC - AB = 2d \sin \theta - \frac{\varphi_r}{\pi} \lambda = m \lambda \quad (m = 0, 1, 2 \dots)$$

SO:

$$\tan \left(\frac{\pi d}{\lambda} \sin \theta - m \frac{\pi}{2} \right) = \left(\frac{\sin^2(\pi/2 - \theta_c)}{\sin^2 \theta} - 1 \right)^{1/2}$$

Waveguiding

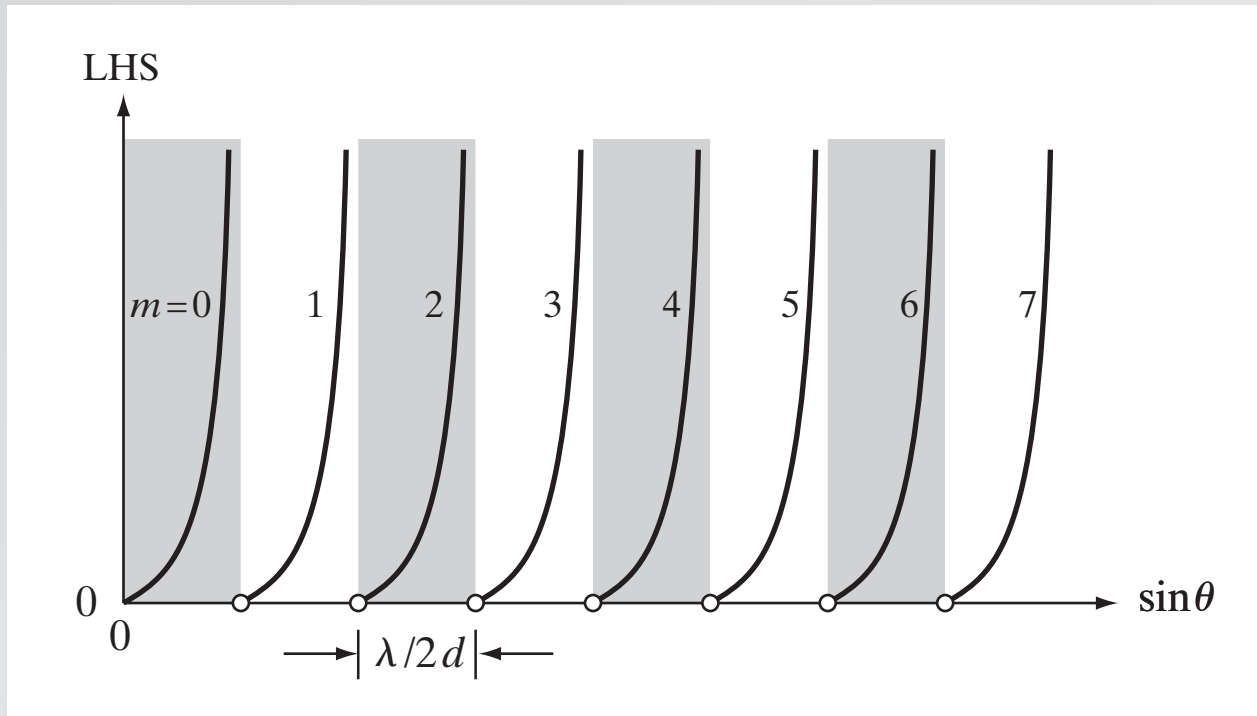

self consistency:

$$AC - AB = 2d \sin \theta - \frac{\varphi_r}{\pi} \lambda = m\lambda \quad (m = 0, 1, 2\dots)$$

SO:

$$\tan \left(\frac{\pi d}{\lambda} \sin \theta - m \frac{\pi}{2} \right) = \left(\frac{\sin^2(\pi/2 - \theta_c)}{\sin^2 \theta} - 1 \right)^{1/2}$$

Waveguiding

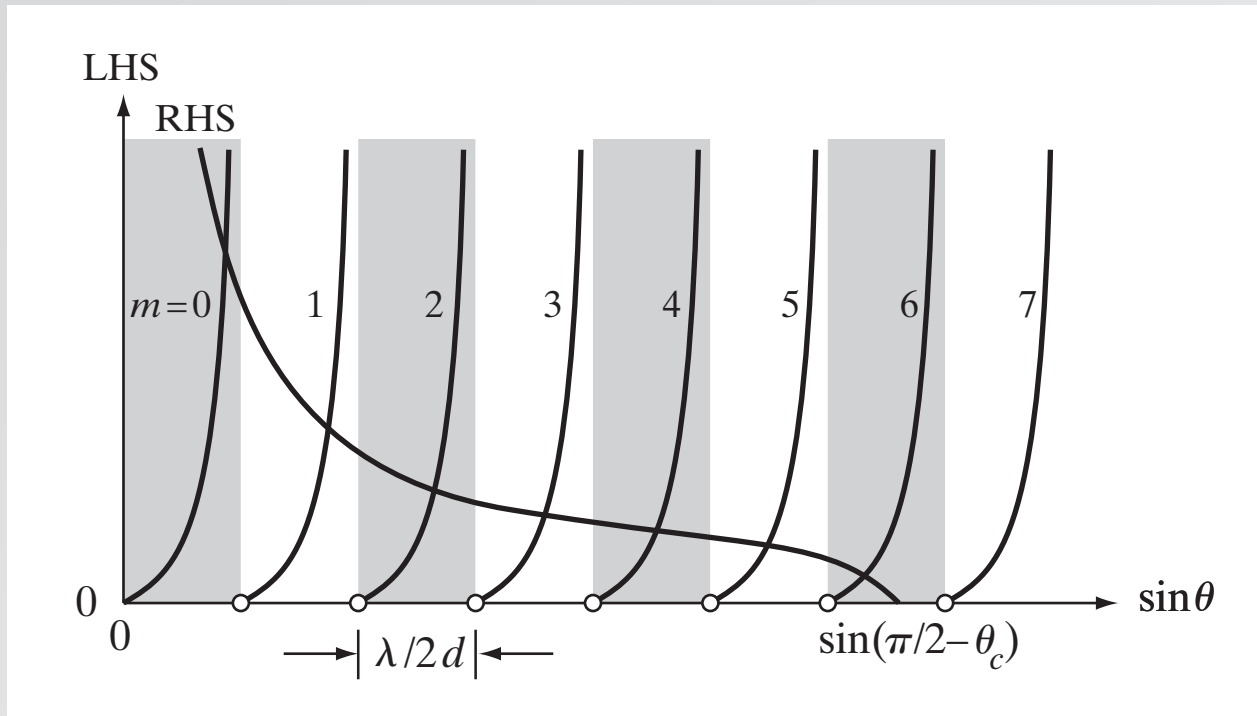

self consistency:

$$AC - AB = 2d \sin \theta - \frac{\varphi_r}{\pi} \lambda = m \lambda \quad (m = 0, 1, 2 \dots)$$

SO:

$$\tan \left(\frac{\pi d}{\lambda} \sin \theta - m \frac{\pi}{2} \right) = \left(\frac{\sin^2(\pi/2 - \theta_c)}{\sin^2 \theta} - 1 \right)^{1/2}$$

Waveguiding

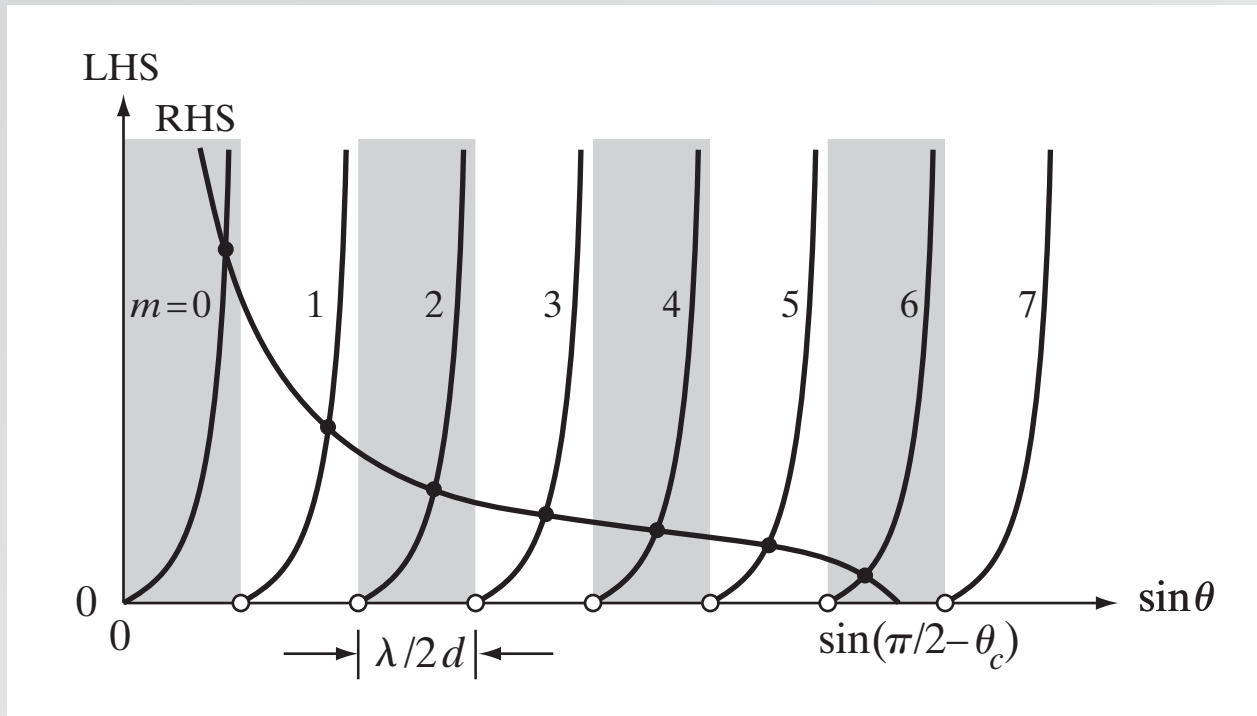

self consistency:

$$AC - AB = 2d \sin \theta - \frac{\varphi_r}{\pi} \lambda = m \lambda \quad (m = 0, 1, 2 \dots)$$

SO:

$$\tan \left(\frac{\pi d}{\lambda} \sin \theta - m \frac{\pi}{2} \right) = \left(\frac{\sin^2(\pi/2 - \theta_c)}{\sin^2 \theta} - 1 \right)^{1/2}$$

Waveguiding

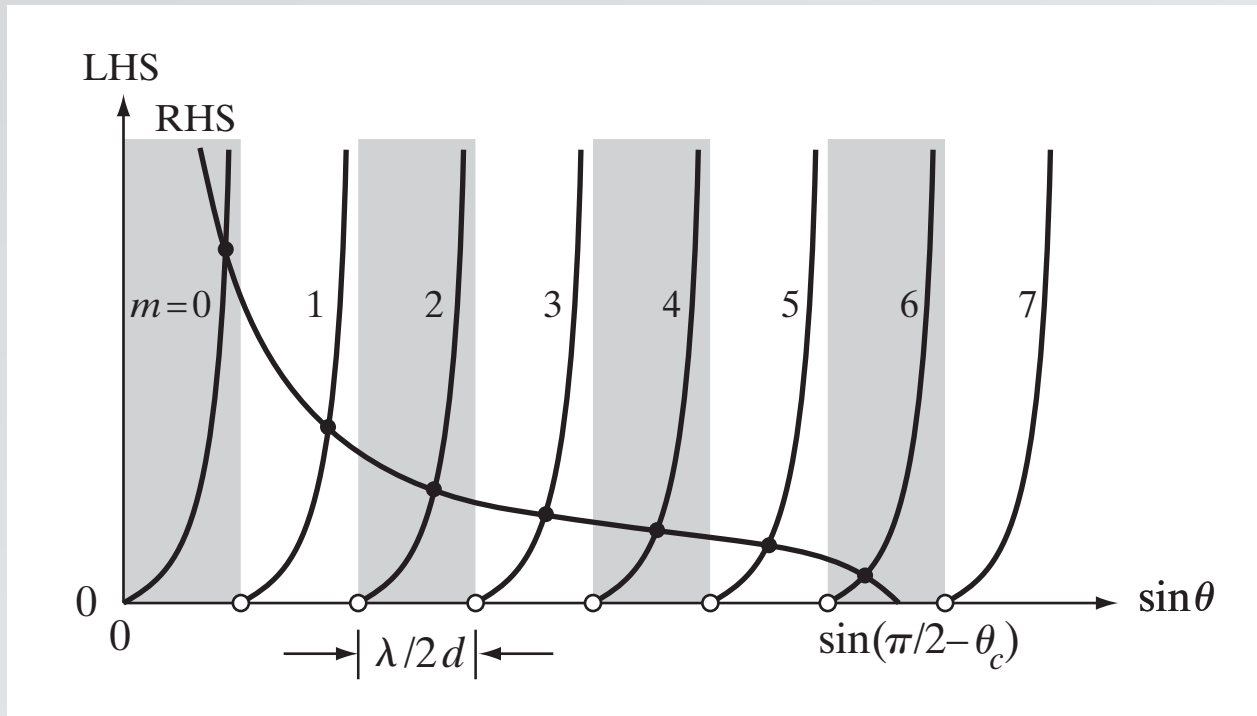

number of modes:

$$M \doteq \frac{\sin(\pi/2 - \theta_c)}{\lambda/2d}$$

Waveguiding

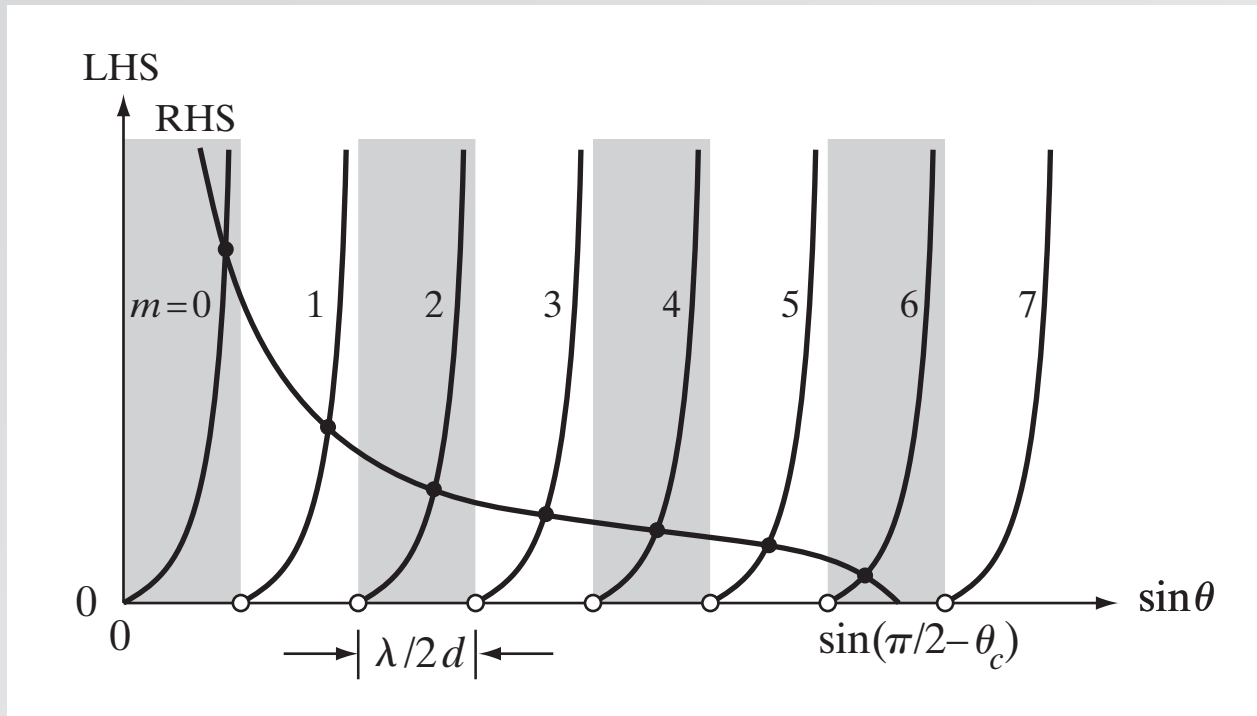

number of modes:

$$M \doteq \frac{\sin(\pi/2 - \theta_c)}{\lambda/2d}$$

or:

$$M \doteq 2 \frac{d}{\lambda} (n_1^2 - n_2^2)^{1/2}$$

Waveguiding

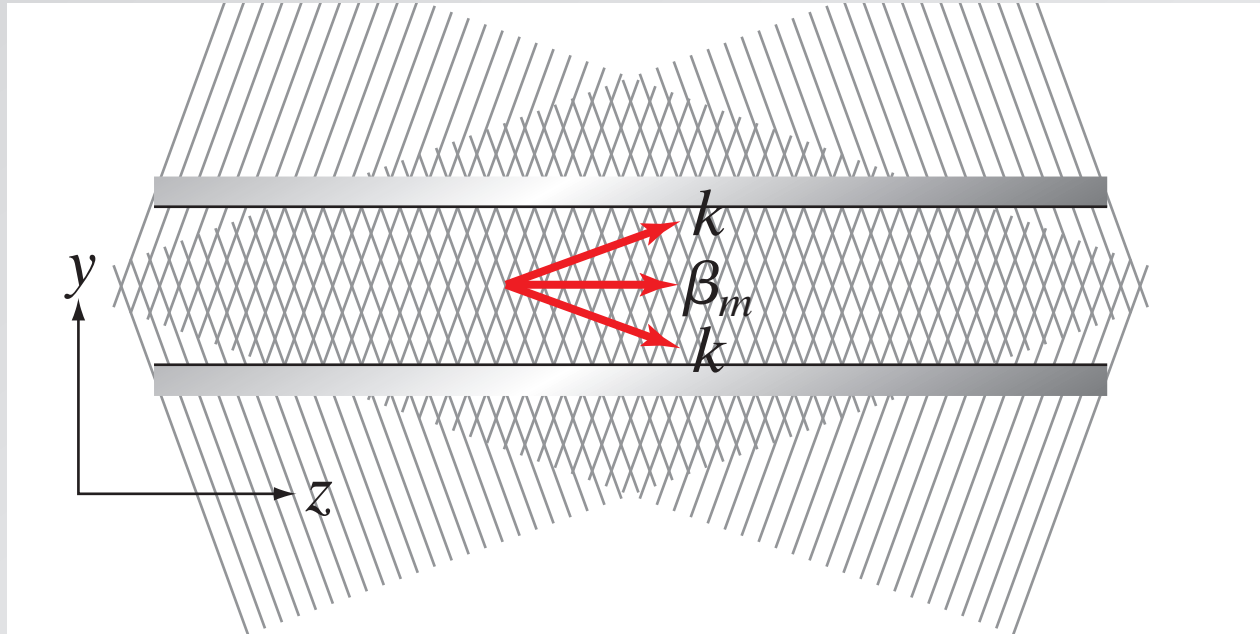

propagation constant of guided wave:

$$\beta_m^2 = k^2 - k_y^2 = k^2 - \frac{m^2 \pi^2}{d^2}$$

group velocity:

$$v_m = c \cos \theta_m$$

Waveguiding

single mode condition for 600-nm light:

planar mirror

$$M \doteq \frac{2d}{\lambda}$$

$$300 < d < 600 \text{ nm}$$

dielectric

$$M \doteq 2 \frac{d}{\lambda} (n_1^2 - n_2^2)^{1/2}$$

$$d < 268 \text{ nm}$$

Waveguiding

single mode condition for 600-nm light:

planar mirror

$$M \doteq \frac{2d}{\lambda}$$

$$300 < d < 600 \text{ nm}$$

dielectric

$$M \doteq 2 \frac{d}{\lambda} (n_1^2 - n_2^2)^{1/2}$$

$$d < 268 \text{ nm}$$

can make d larger by making $n_1 - n_2$ smaller!

Waveguiding

Vector potential obeys:

$$\nabla^2 \vec{A} + \omega^2 \mu_o \epsilon \vec{A} = -i\omega \mu_o \nabla \epsilon \Phi$$

Waveguiding

Vector potential obeys:

$$\nabla^2 \vec{A} + \omega^2 \mu_o \epsilon \vec{A} = 0$$

Waveguiding

Vector potential obeys:

$$\nabla^2 \vec{A} + \omega^2 \mu_o \epsilon \vec{A} = 0$$

Substituting

$$\vec{A} = \hat{y} u(x,y) e^{-i\beta z}$$

Waveguiding

Vector potential obeys:

$$\nabla^2 \vec{A} + \omega^2 \mu_o \epsilon \vec{A} = 0$$

Substituting

$$\vec{A} = \hat{y} u(x,y) e^{-i\beta z}$$

yields:

$$\nabla_T^2 u + [-\beta^2 + \omega^2 \mu \epsilon(r)] u = 0$$

Waveguiding

Vector potential obeys:

$$\nabla^2 \vec{A} + \omega^2 \mu_o \epsilon \vec{A} = 0$$

Substituting

$$\vec{A} = \hat{y} u(x,y) e^{-i\beta z}$$

yields:

$$\nabla_T^2 u + [-\beta^2 + \omega^2 \mu \epsilon(r)] u = 0$$

Compare to time-independent Schrödinger equation:

$$\nabla^2 \psi + \frac{2m}{\hbar^2} [E - V(r)] \psi = 0$$

Waveguiding

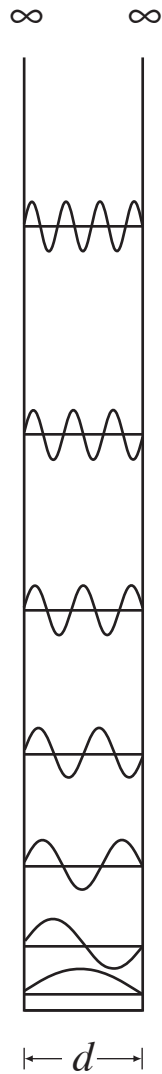

Waveguiding

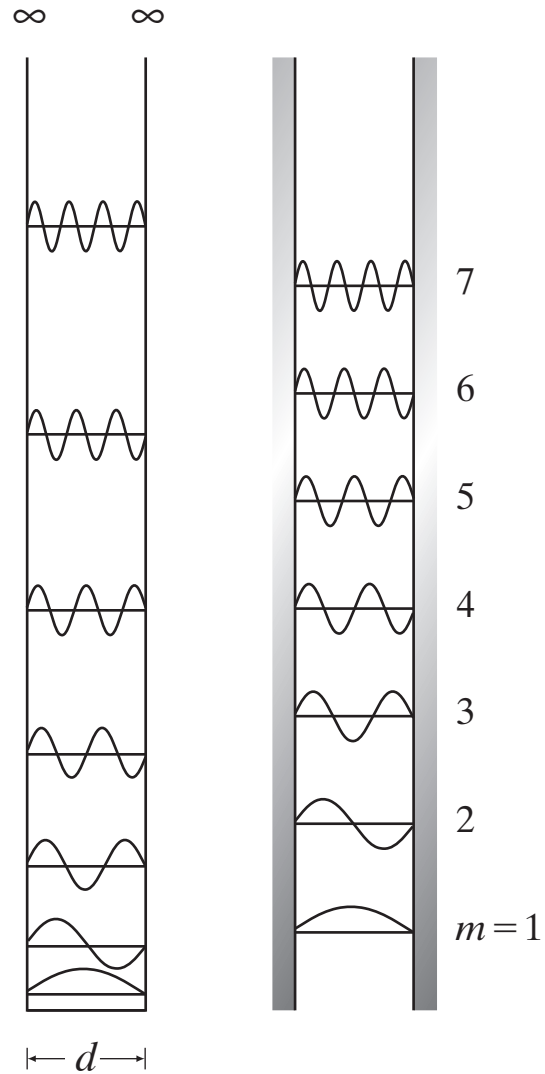

Waveguiding

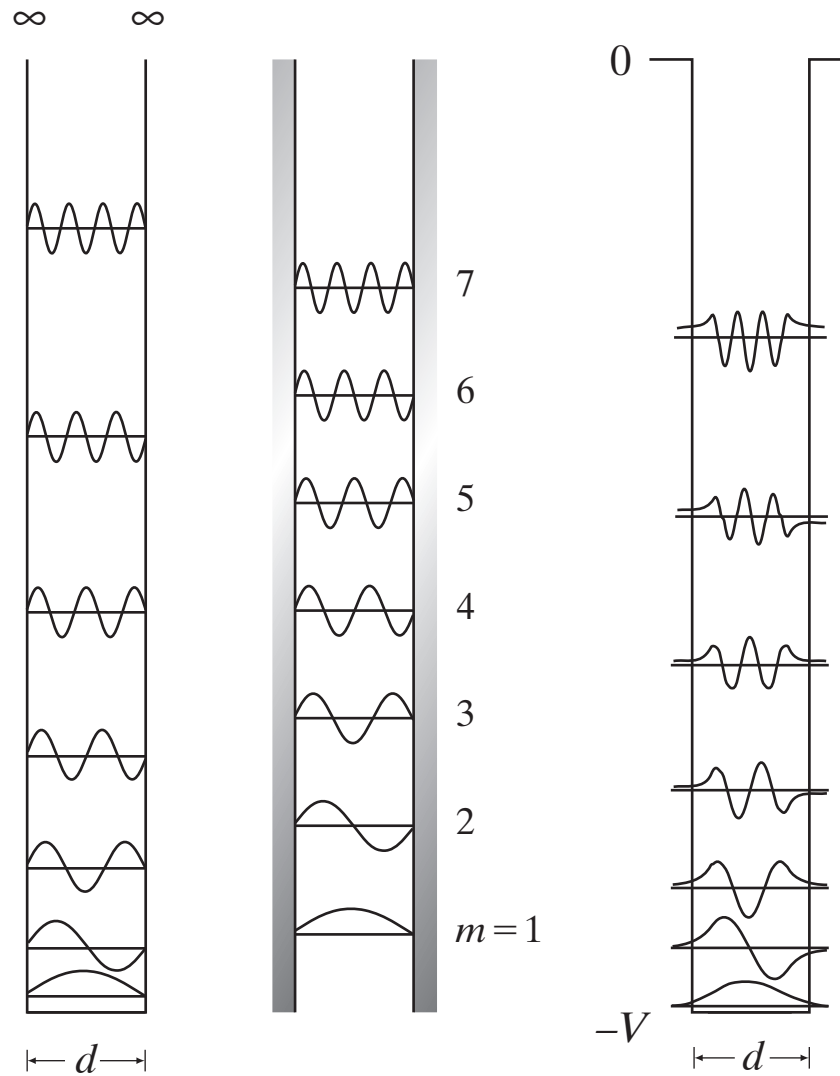

Waveguiding

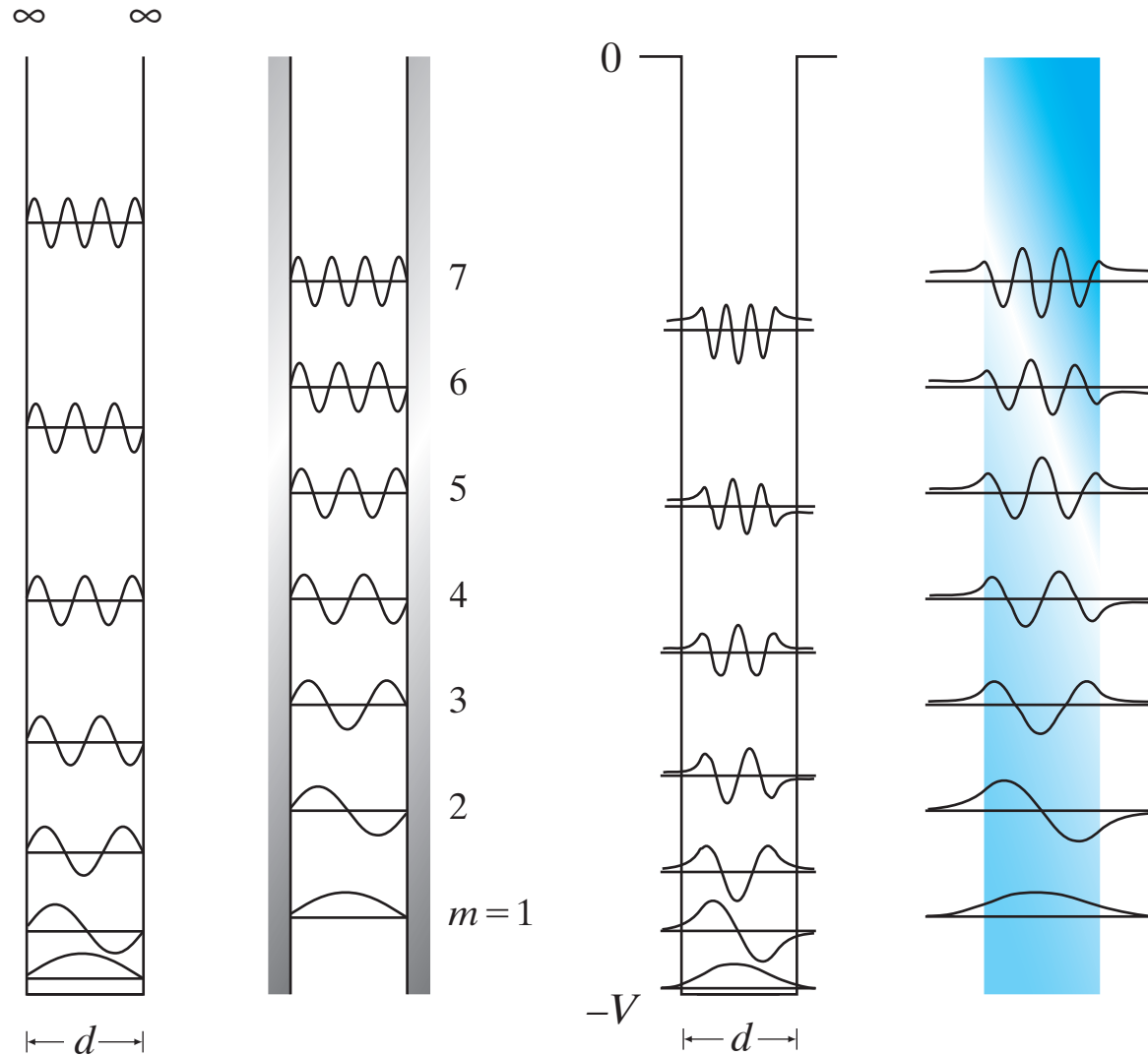

Waveguiding

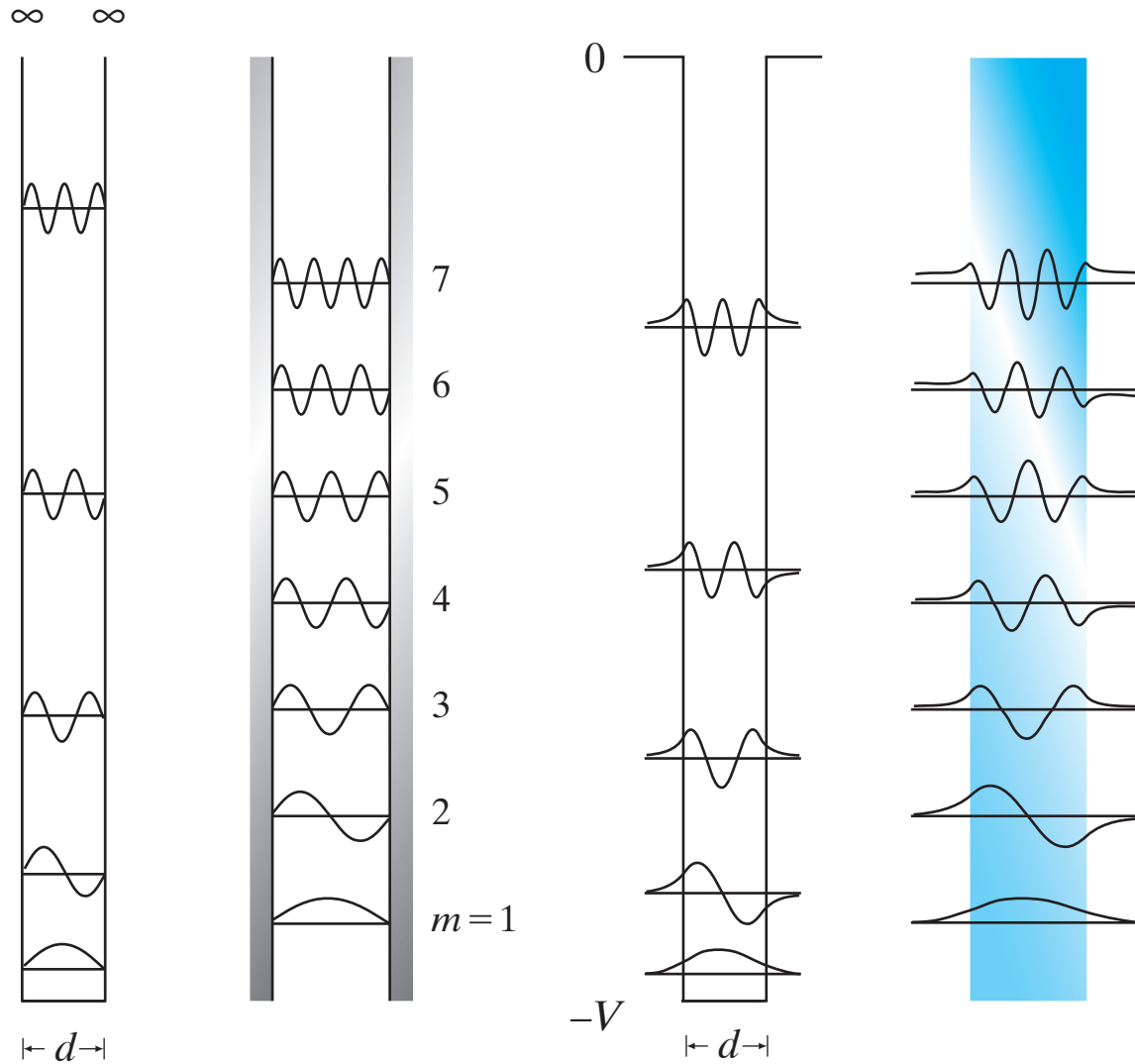

Waveguiding

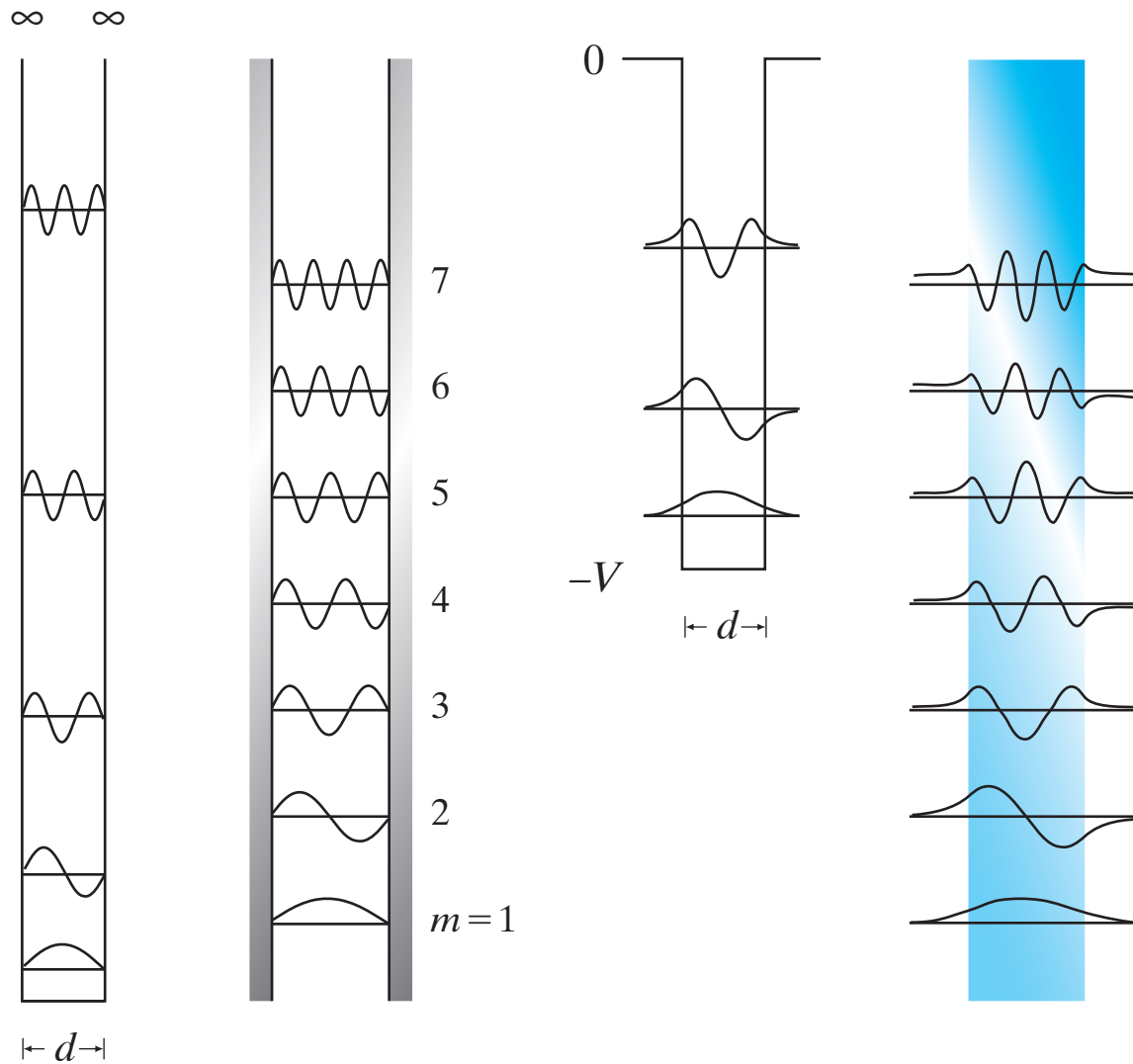

Waveguiding

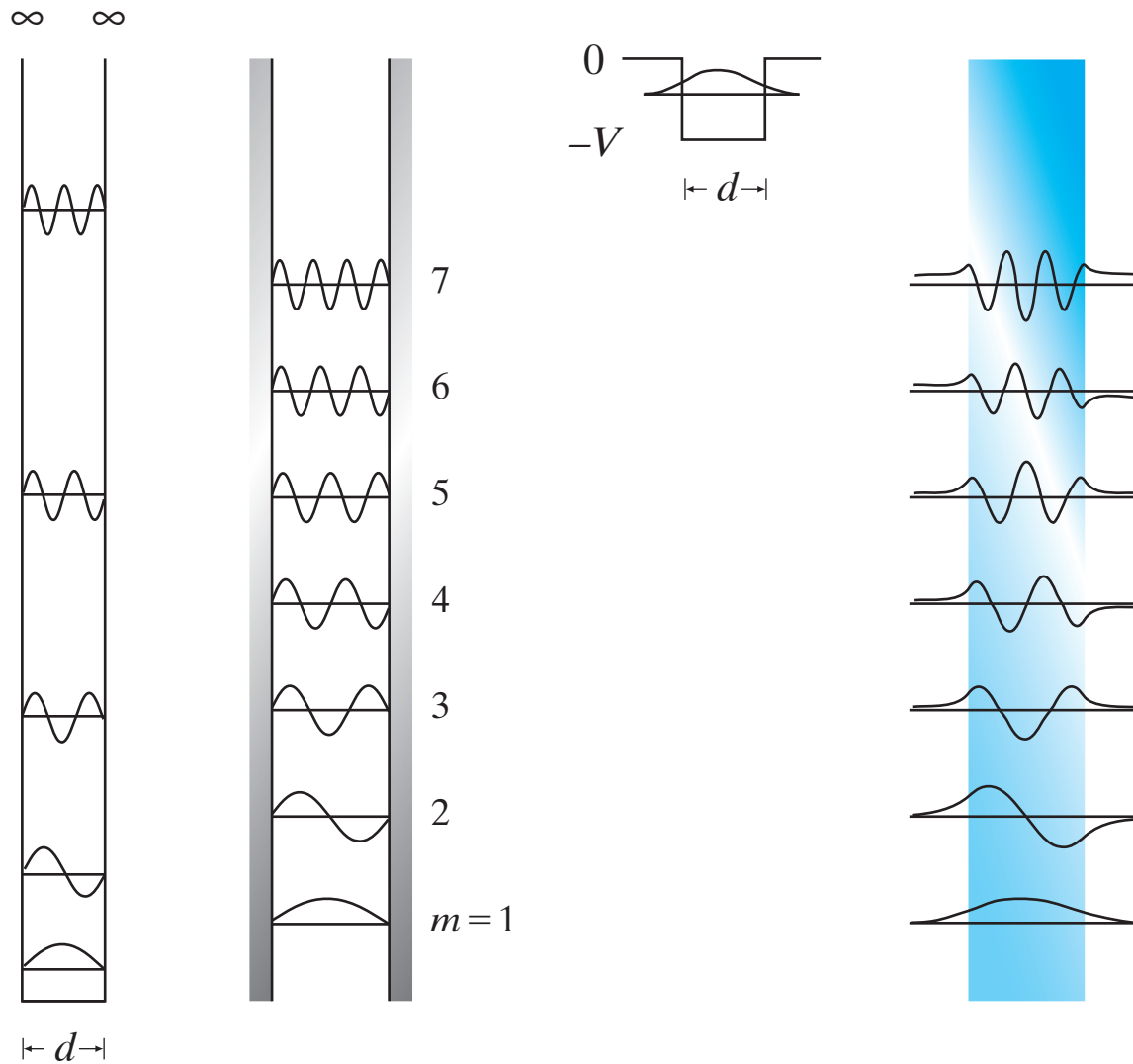

Waveguiding

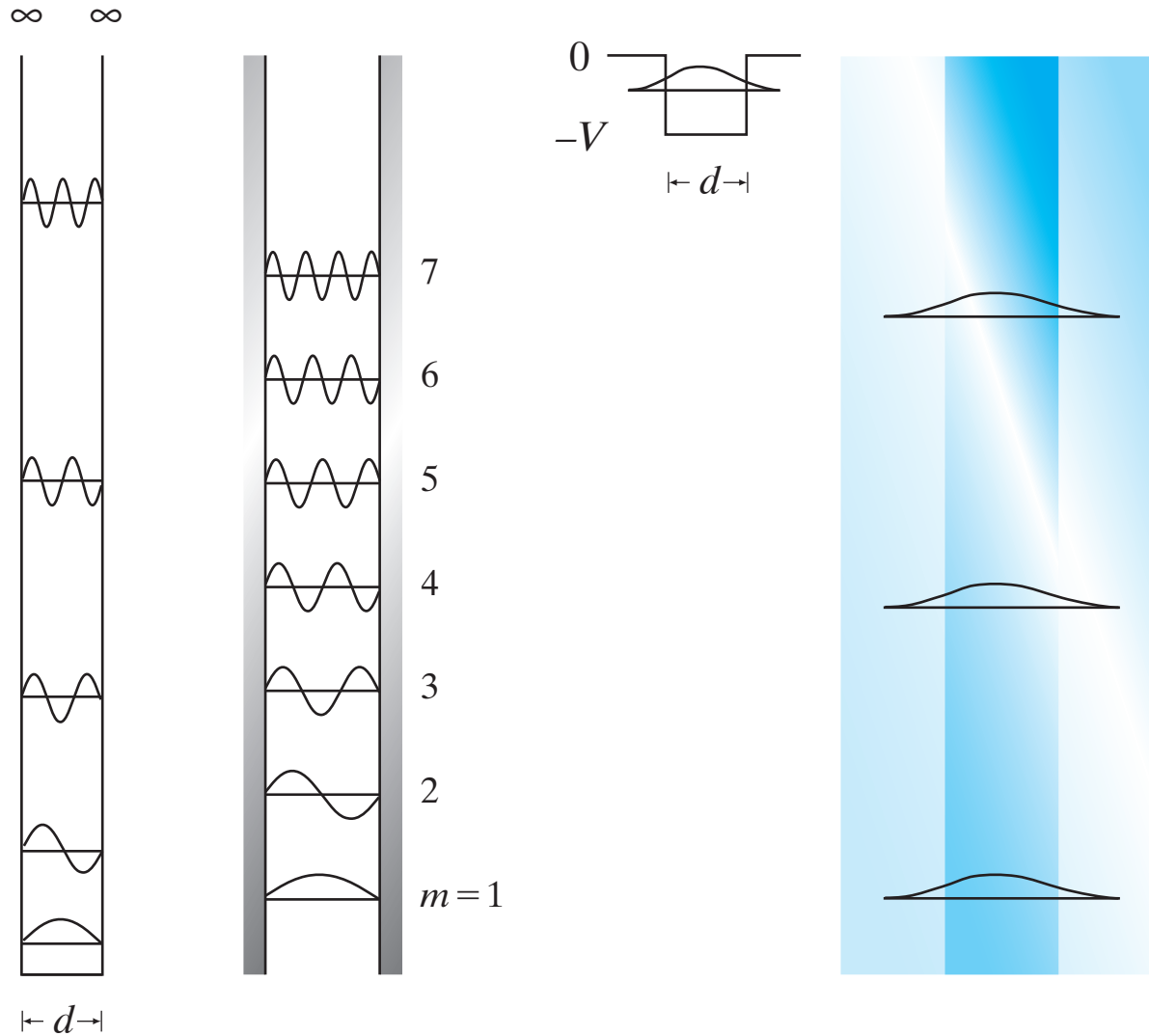

Waveguiding

single mode condition for 600-nm light:

$$M \doteq 2 \frac{d}{\lambda} (n_1^2 - n_2^2)^{1/2}$$

without cladding: $d < 268 \text{ nm}$

Add cladding with 0.4% index difference:

$$d < 5 \text{ } \mu\text{m}$$

Waveguiding

commercial single-mode fiber (Corning Titan[®])



| | core | cladding |
|-----------|-------------------|-----------------------------|
| index | $n_1 = 1.468$ | $n_2 = 1.462$ |
| diameter: | $8.3 \mu\text{m}$ | $125.0 \pm 1.0 \mu\text{m}$ |

operating wavelength: $\lambda = 1310 \text{ nm}/1550 \text{ nm}$

Waveguiding

drawbacks of clad fibers:

- **weak confinement**
- **no tight bending**
- **coupling requires splicing**

Waveguiding

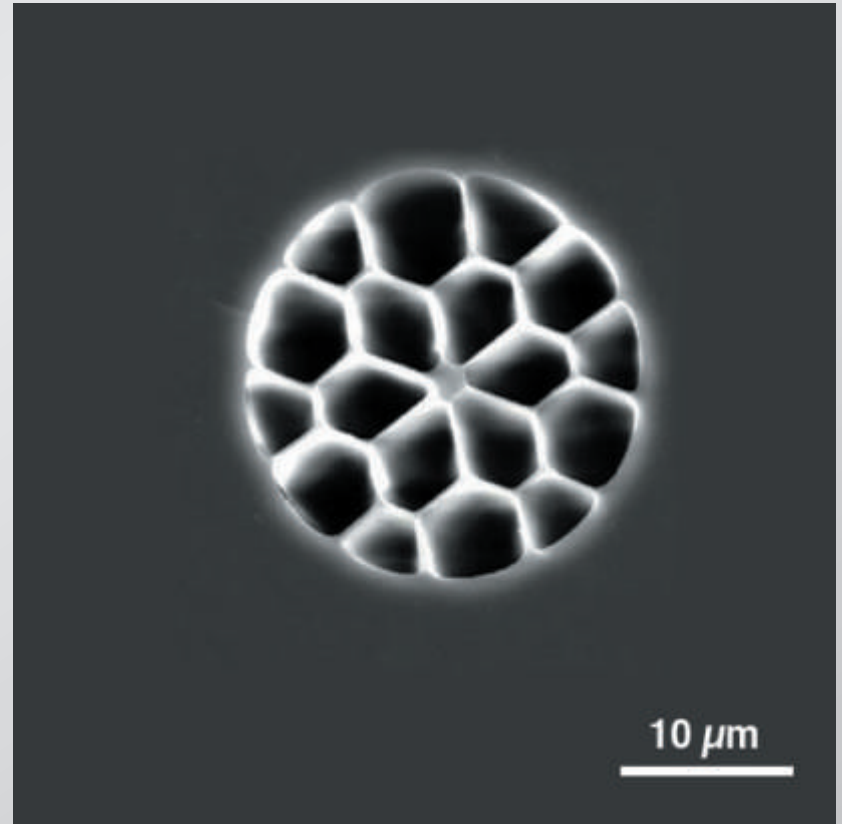
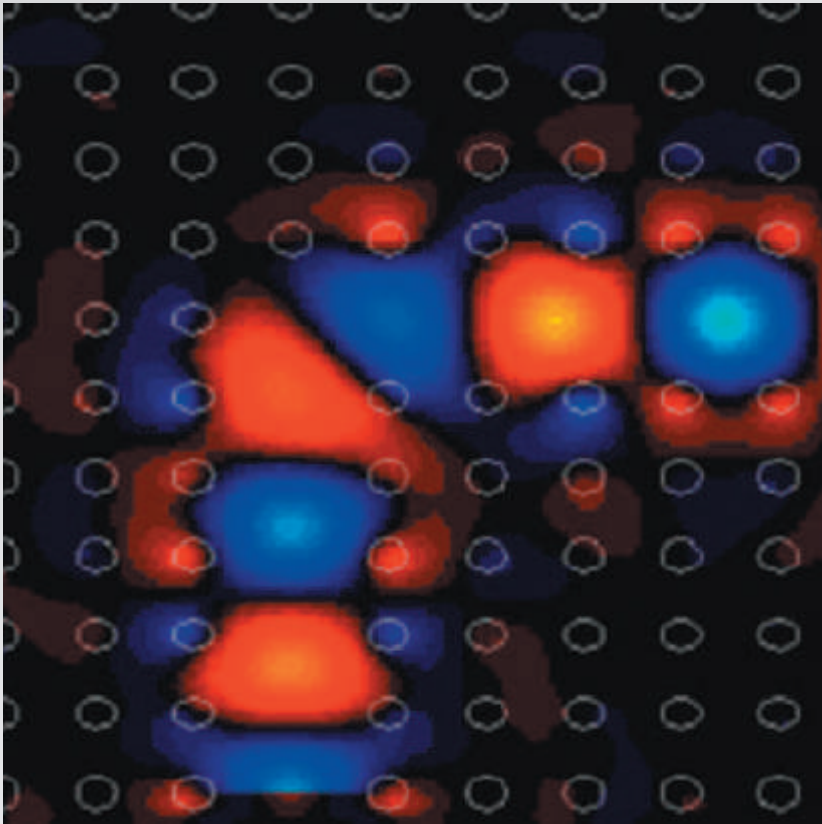

Outline

- waveguiding
- nanowire fabrication
- optical properties

Nanowire fabrication

two-step drawing process

standard
fiber



Nanowire fabrication

two-step drawing process

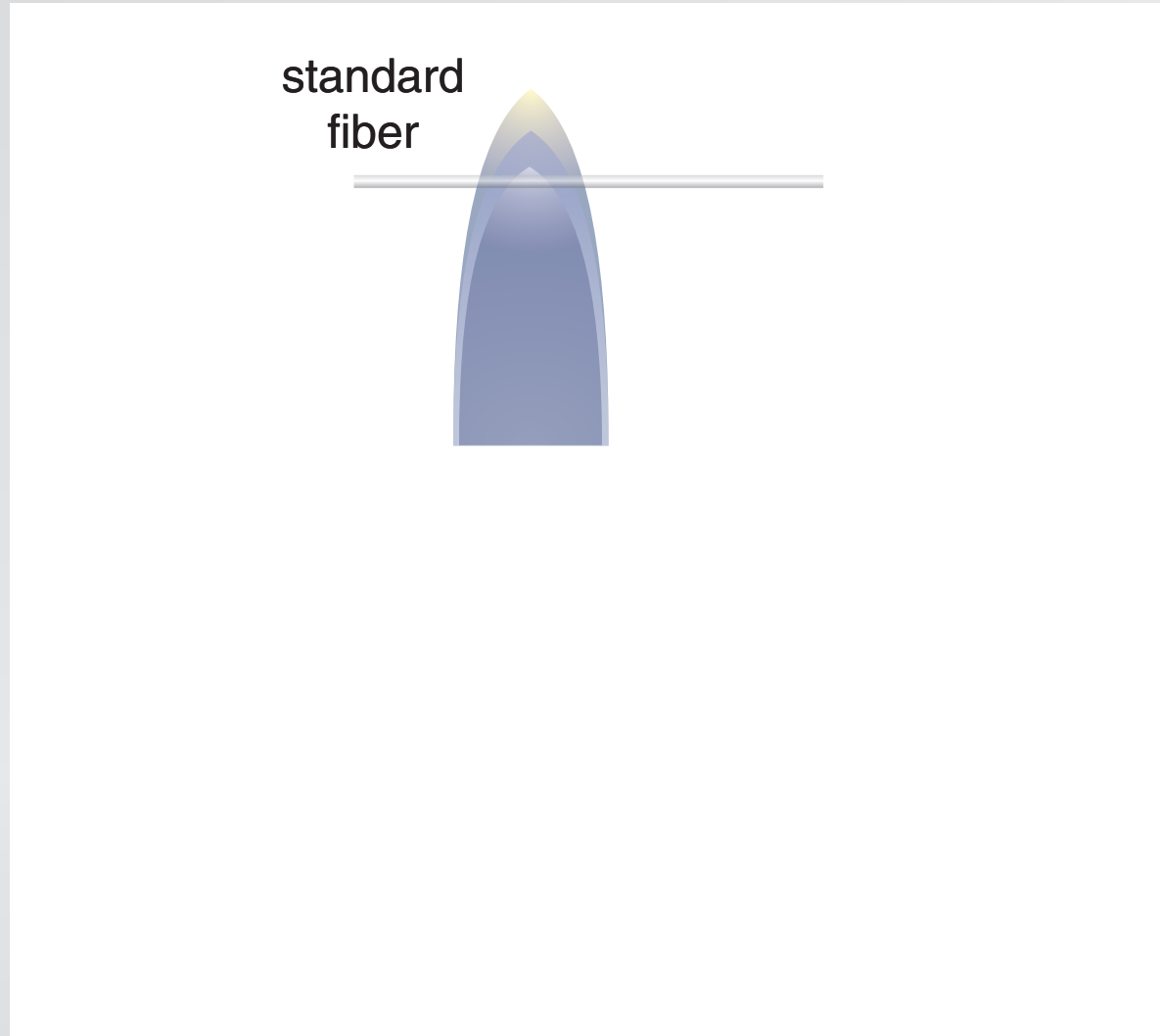

Nanowire fabrication

two-step drawing process

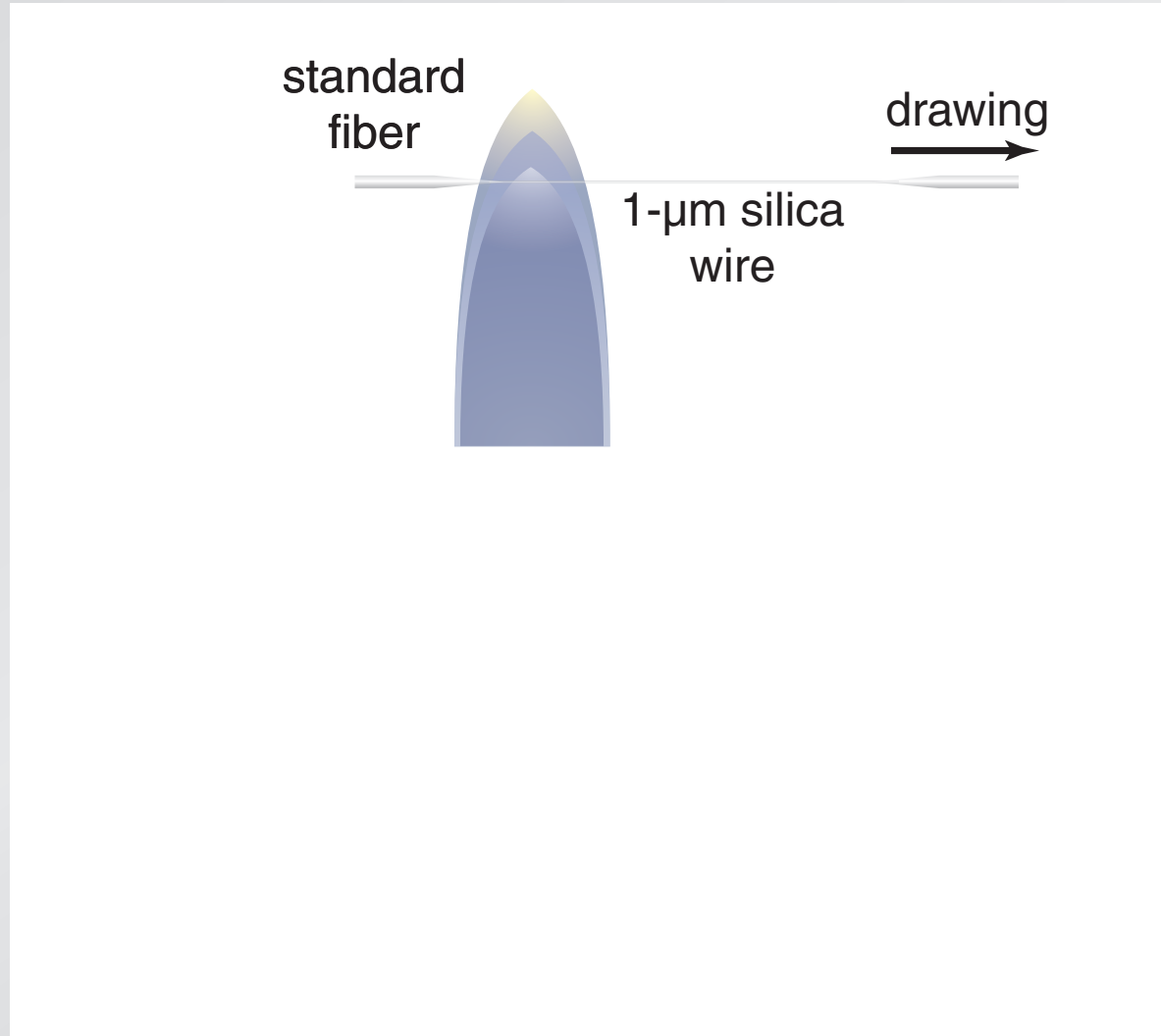

Nanowire fabrication

two-step drawing process

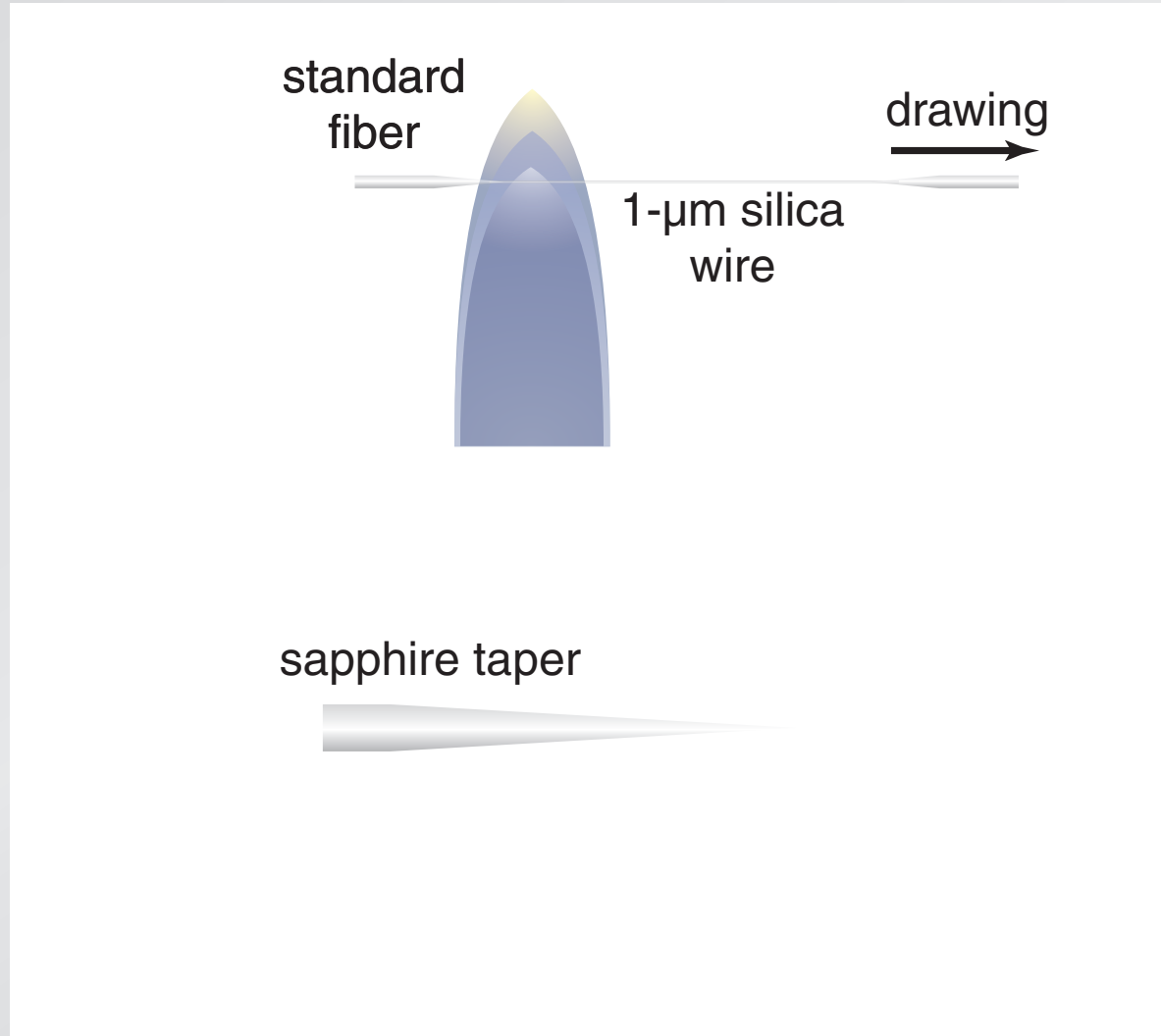

Nanowire fabrication

two-step drawing process

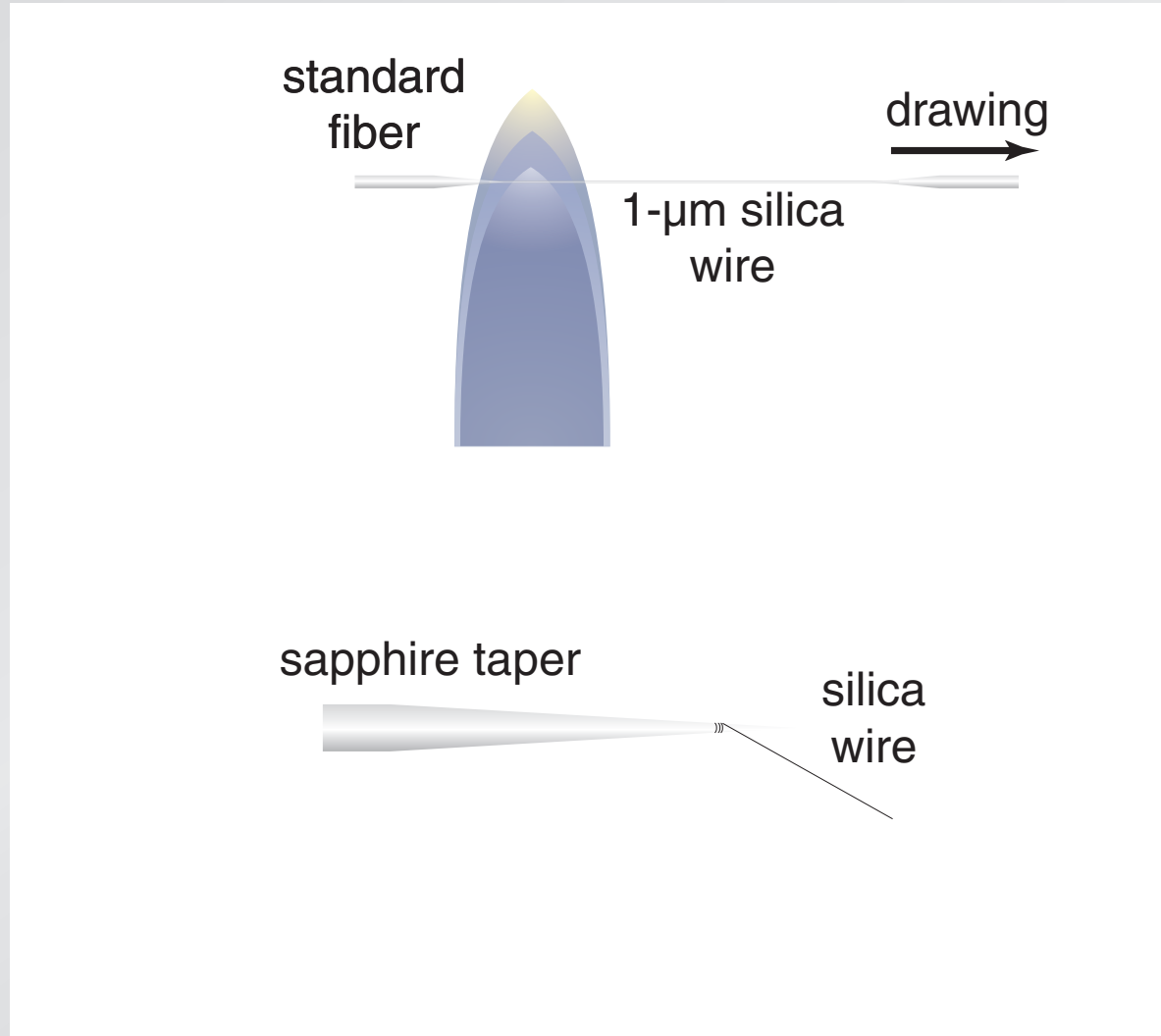

Nanowire fabrication

two-step drawing process

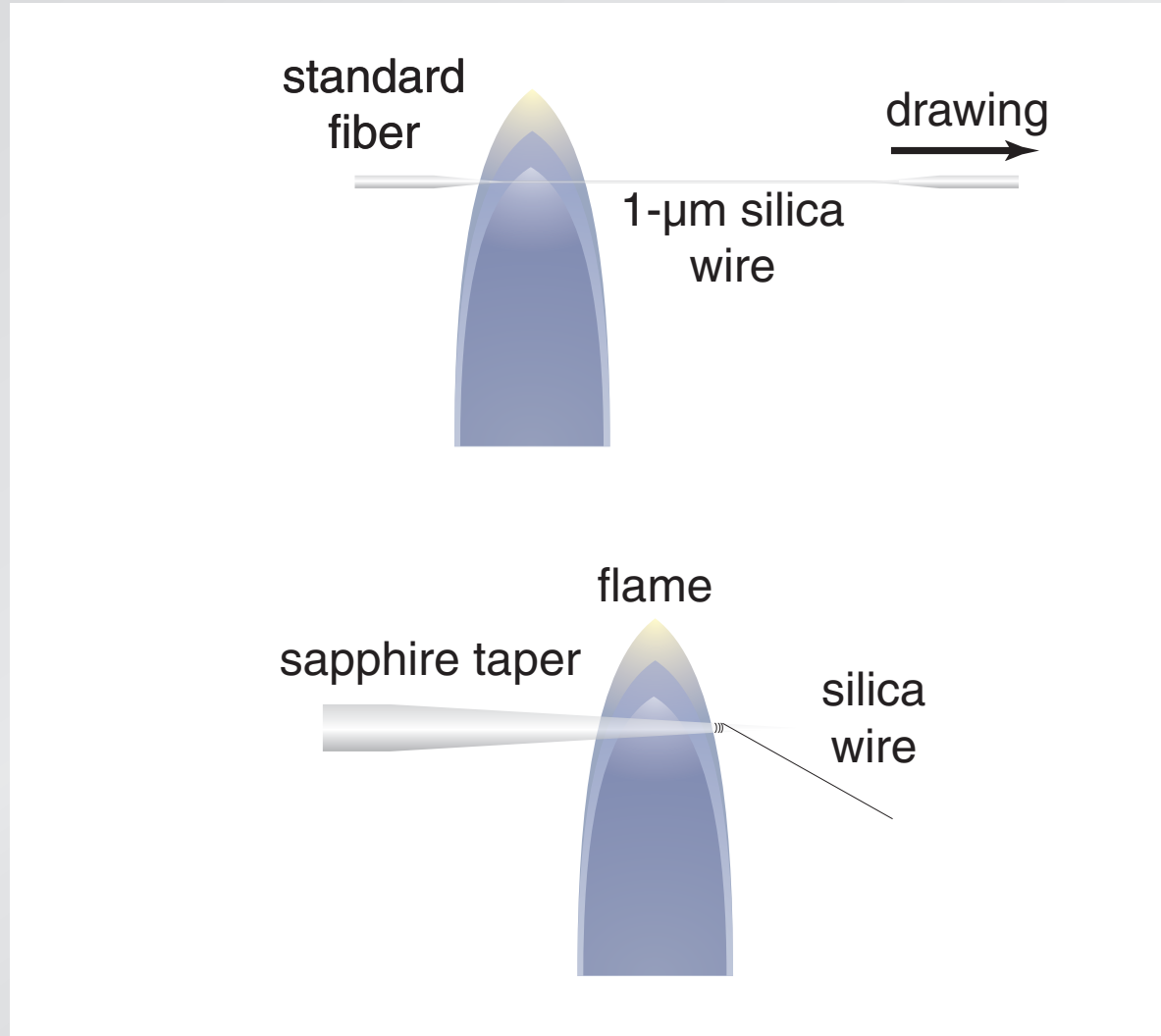

Nanowire fabrication

two-step drawing process

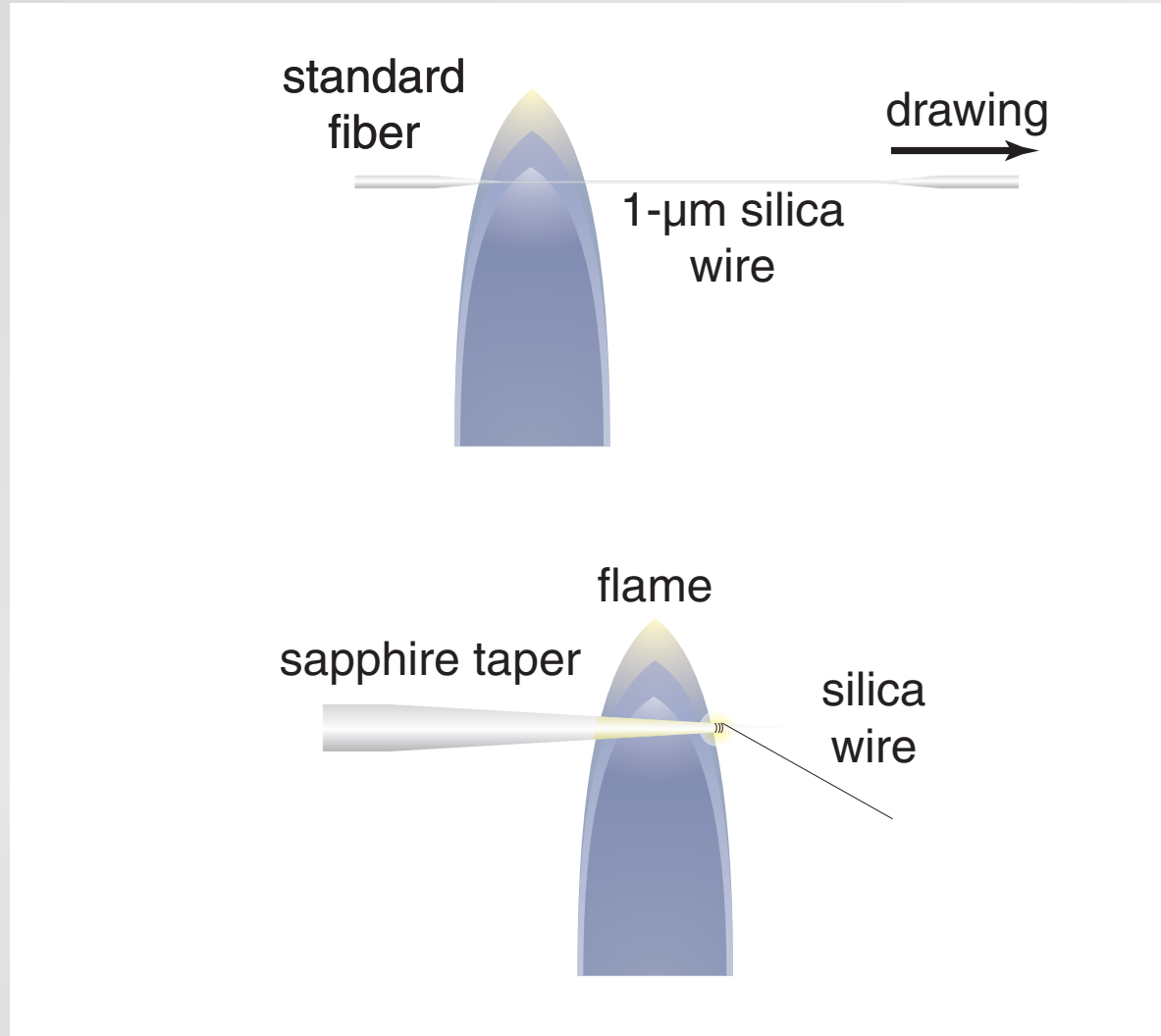

Nanowire fabrication

two-step drawing process

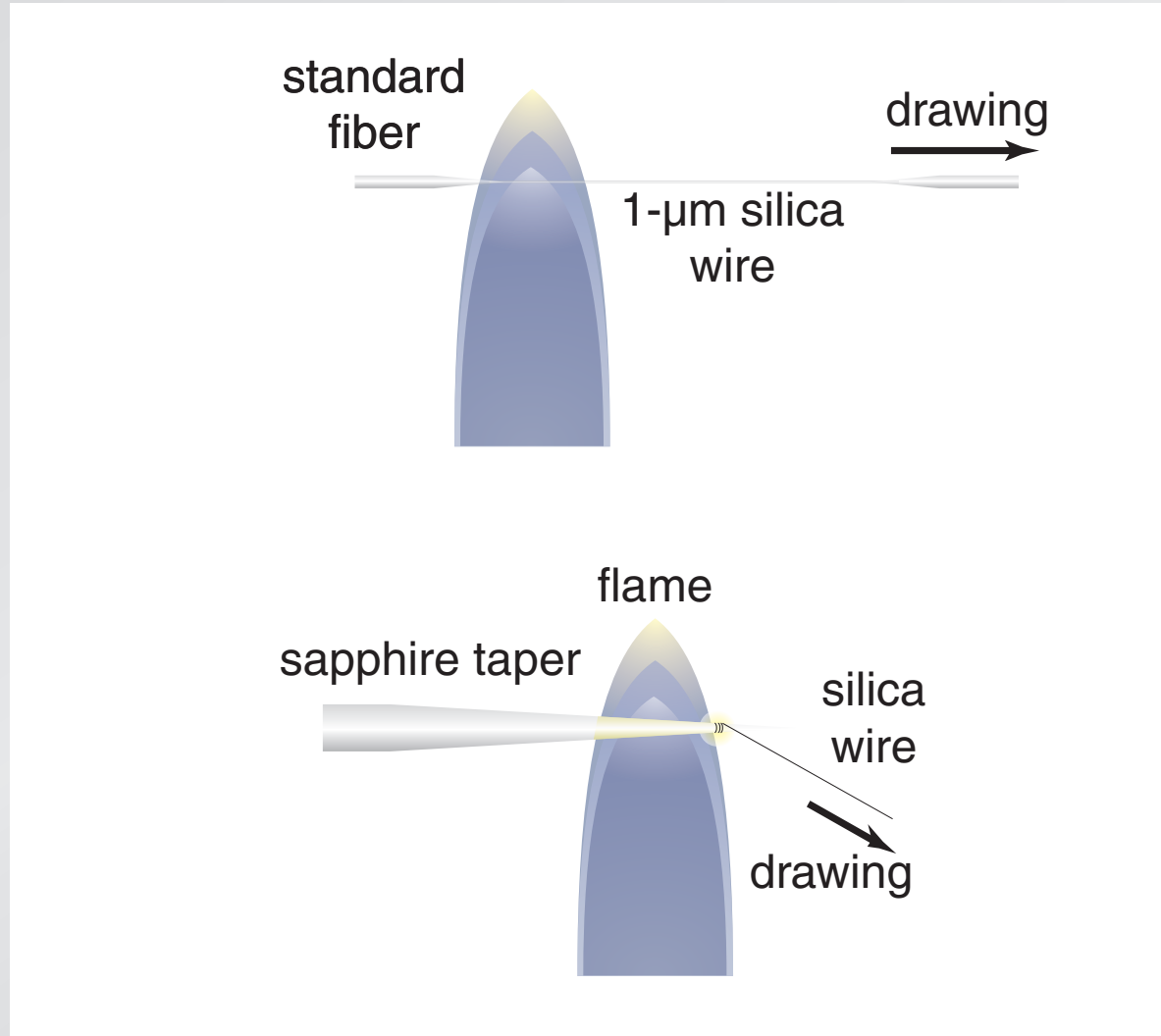

Nanowire fabrication

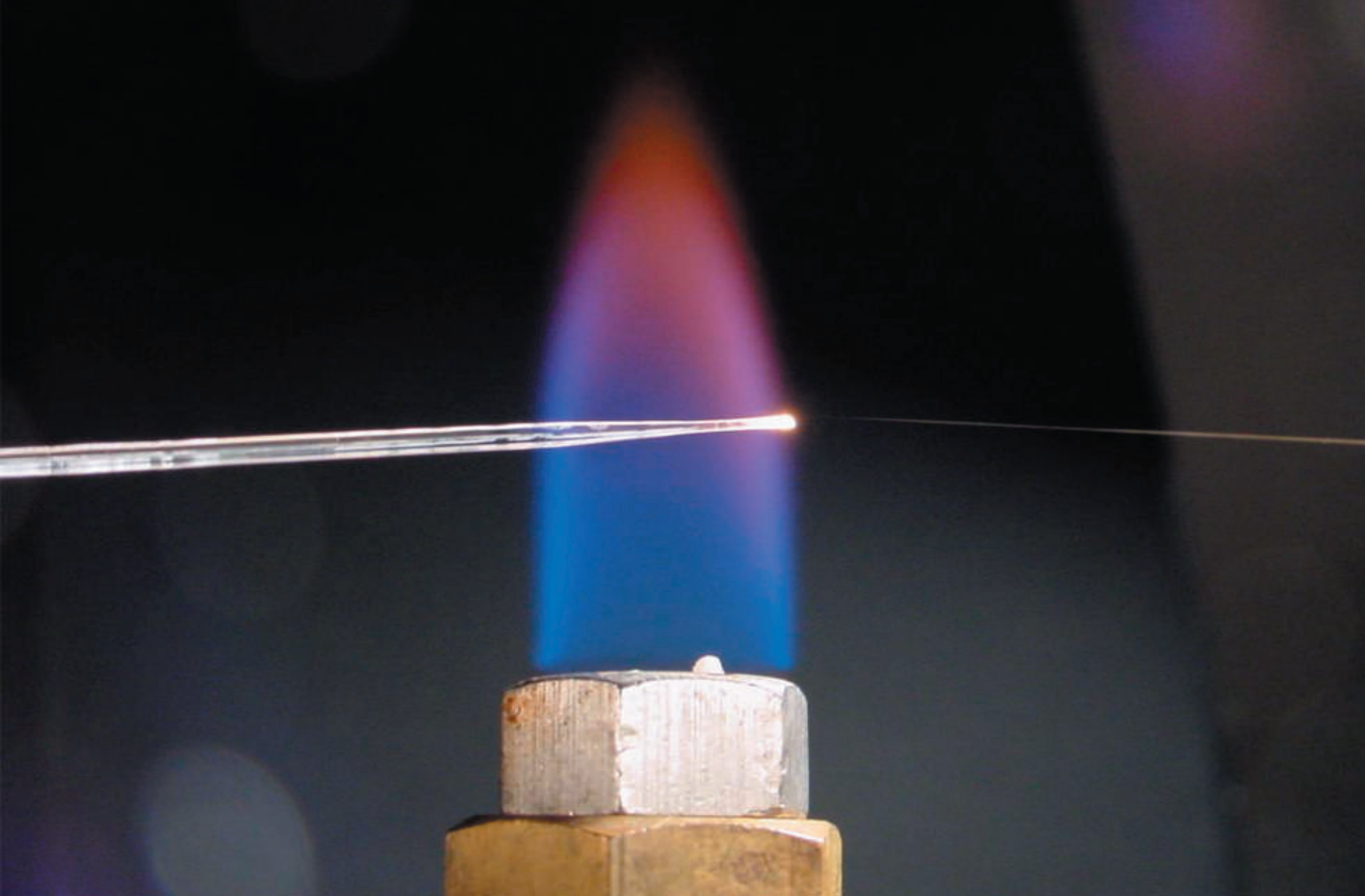

Nanowire fabrication

1 μm



Nature, 426, 816 (2003)

Nanowire fabrication

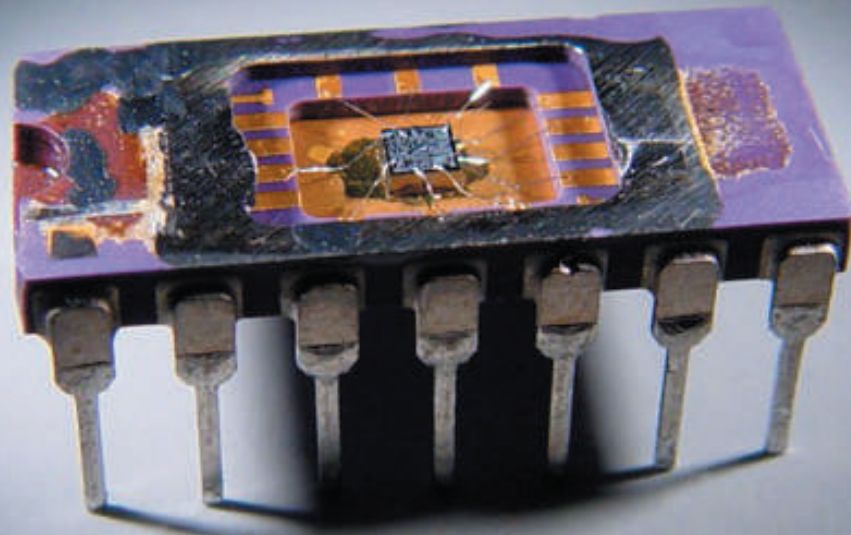

Nanowire fabrication

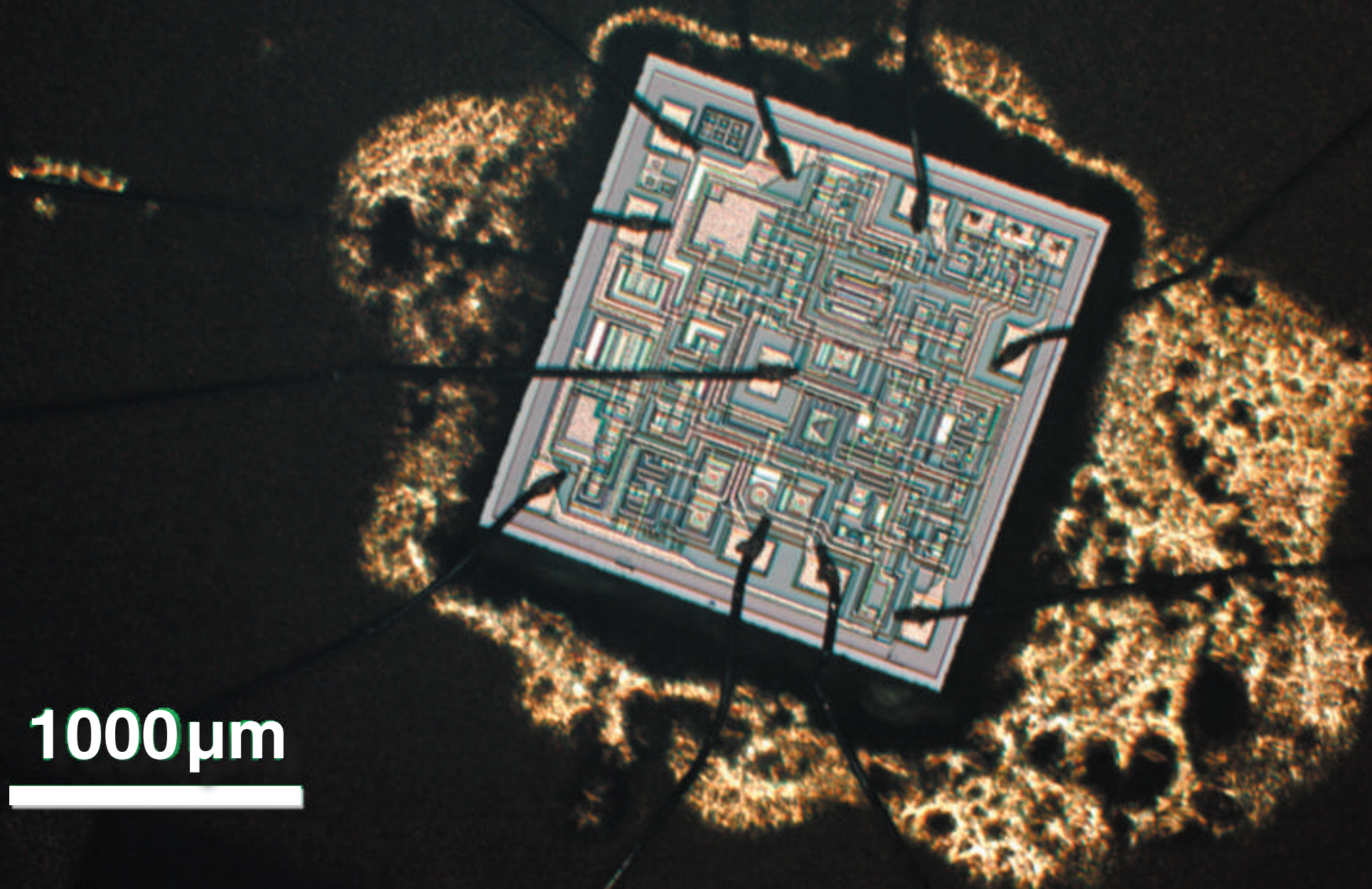

Nanowire fabrication

500 μm

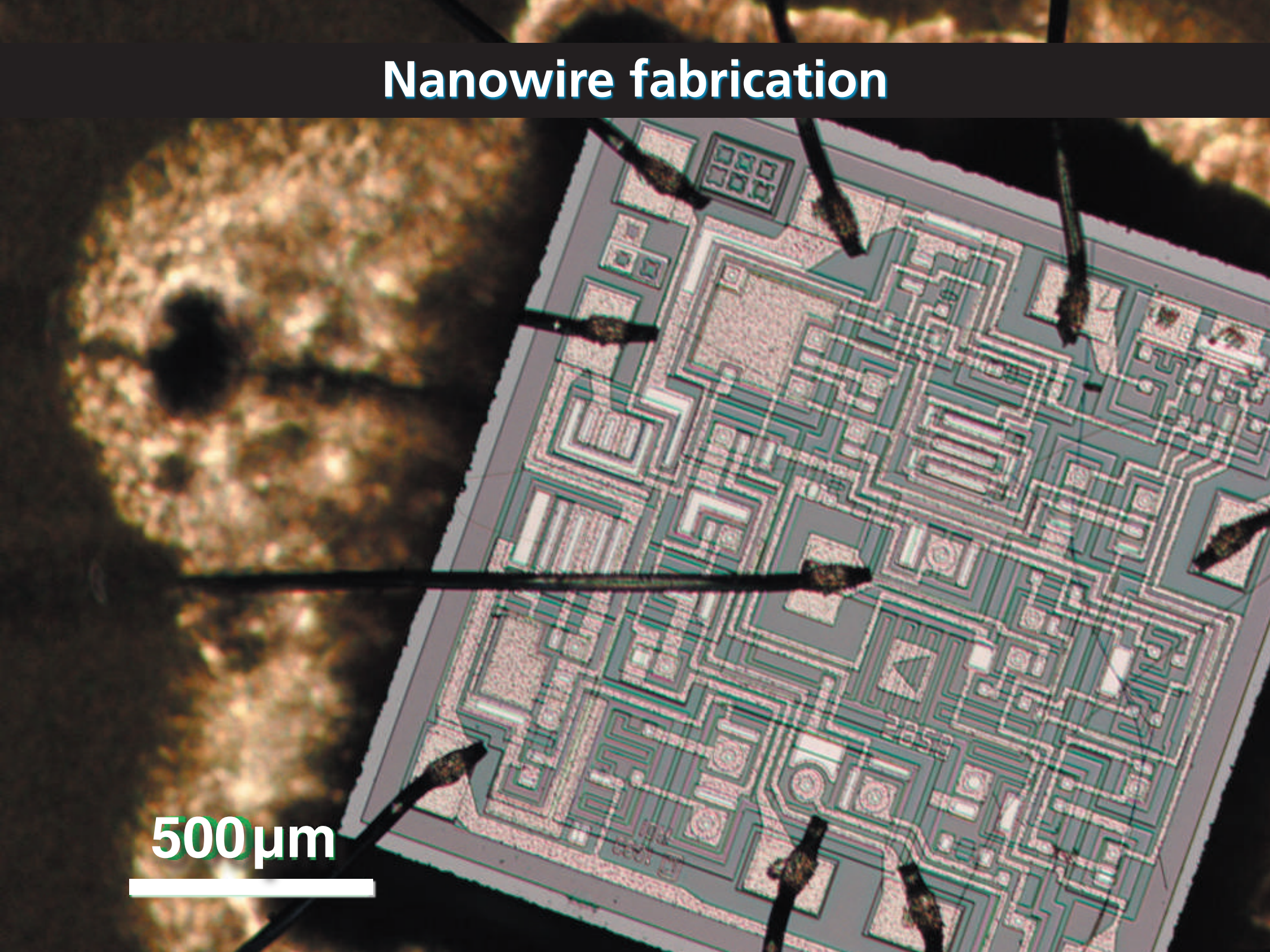

Nanowire fabrication

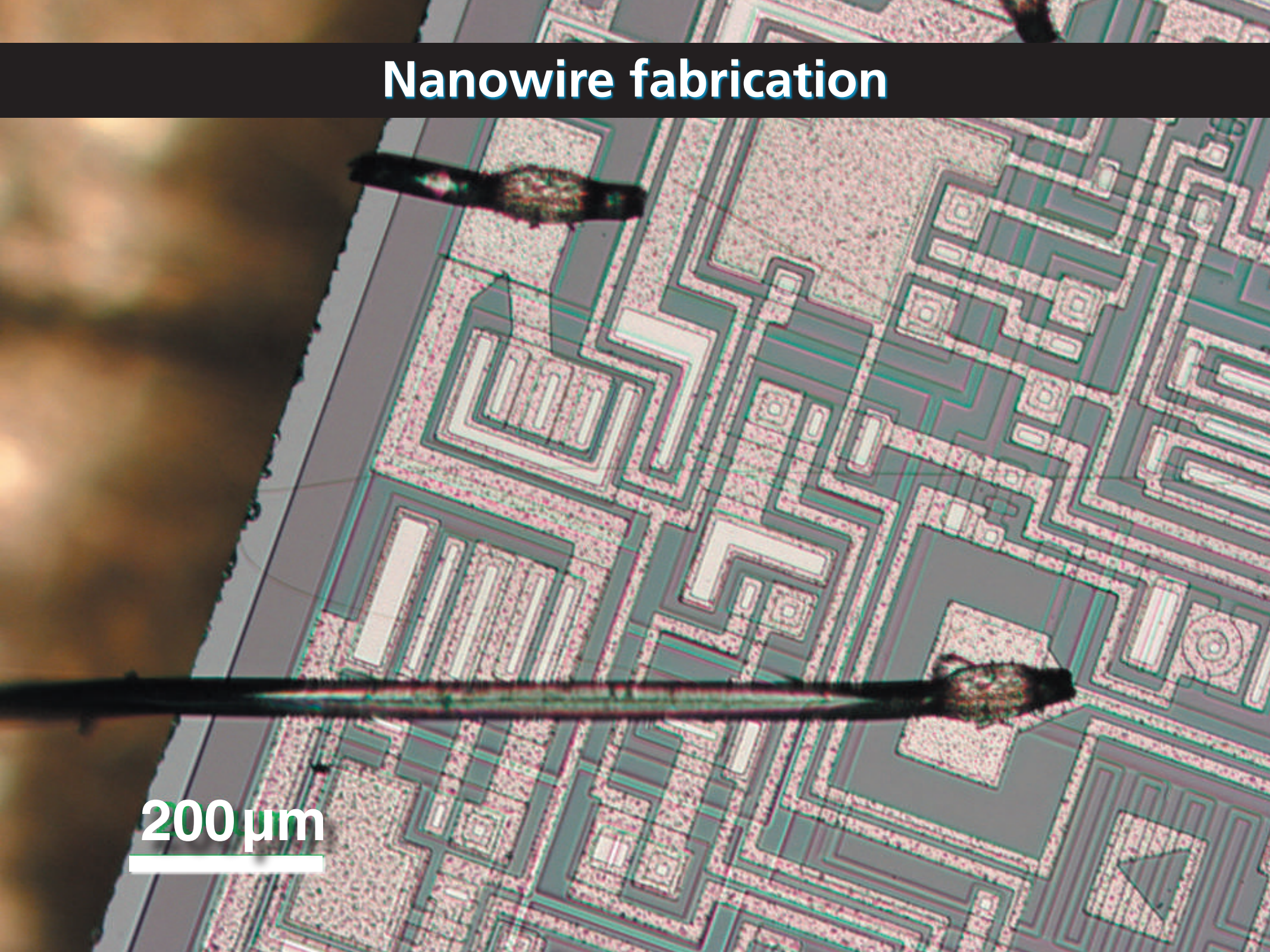

200 μm

Nanowire fabrication

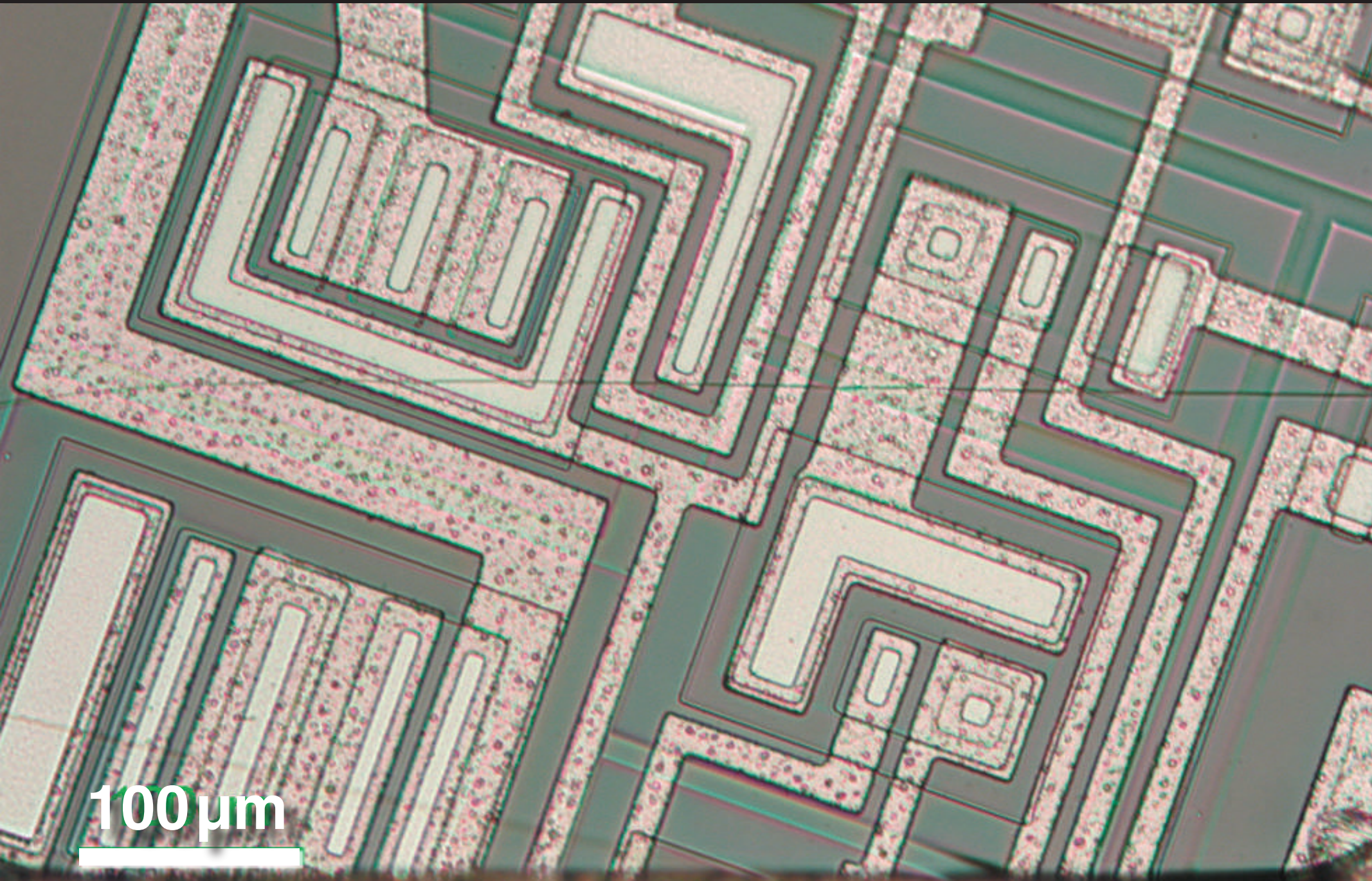

Nanowire fabrication

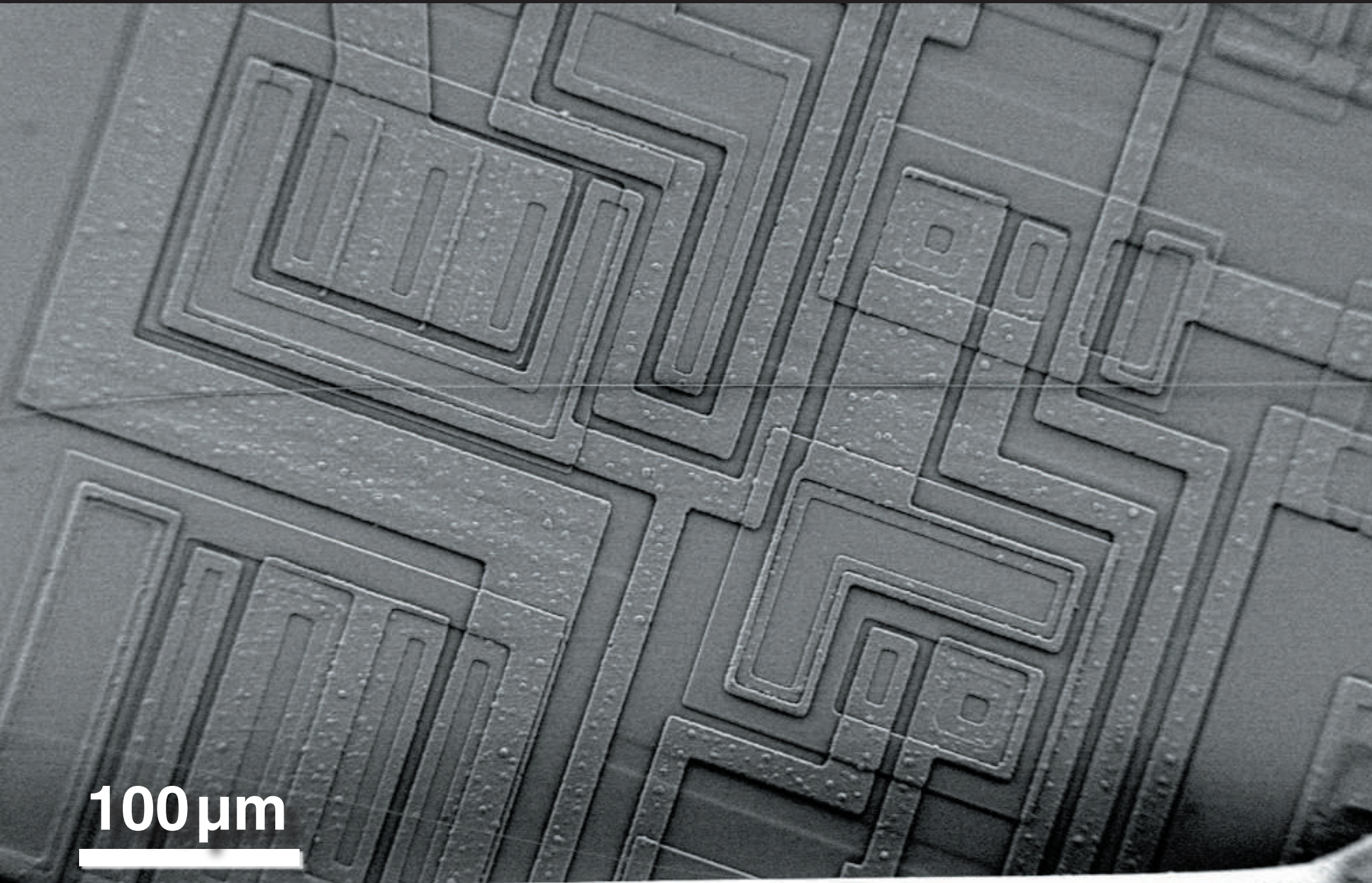

100 μm



Nanowire fabrication

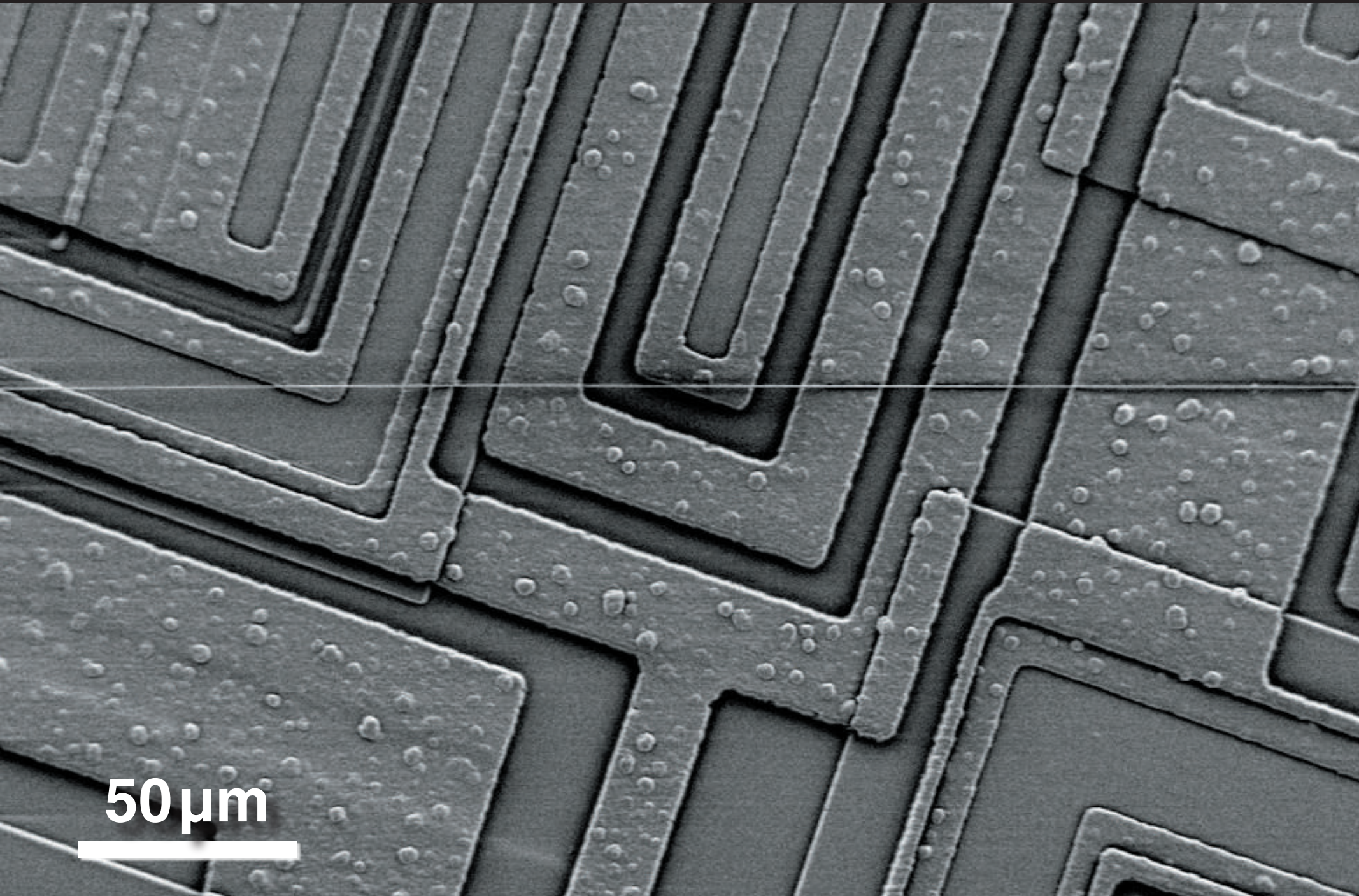

50 μm

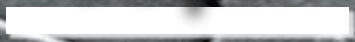

Nanowire fabrication

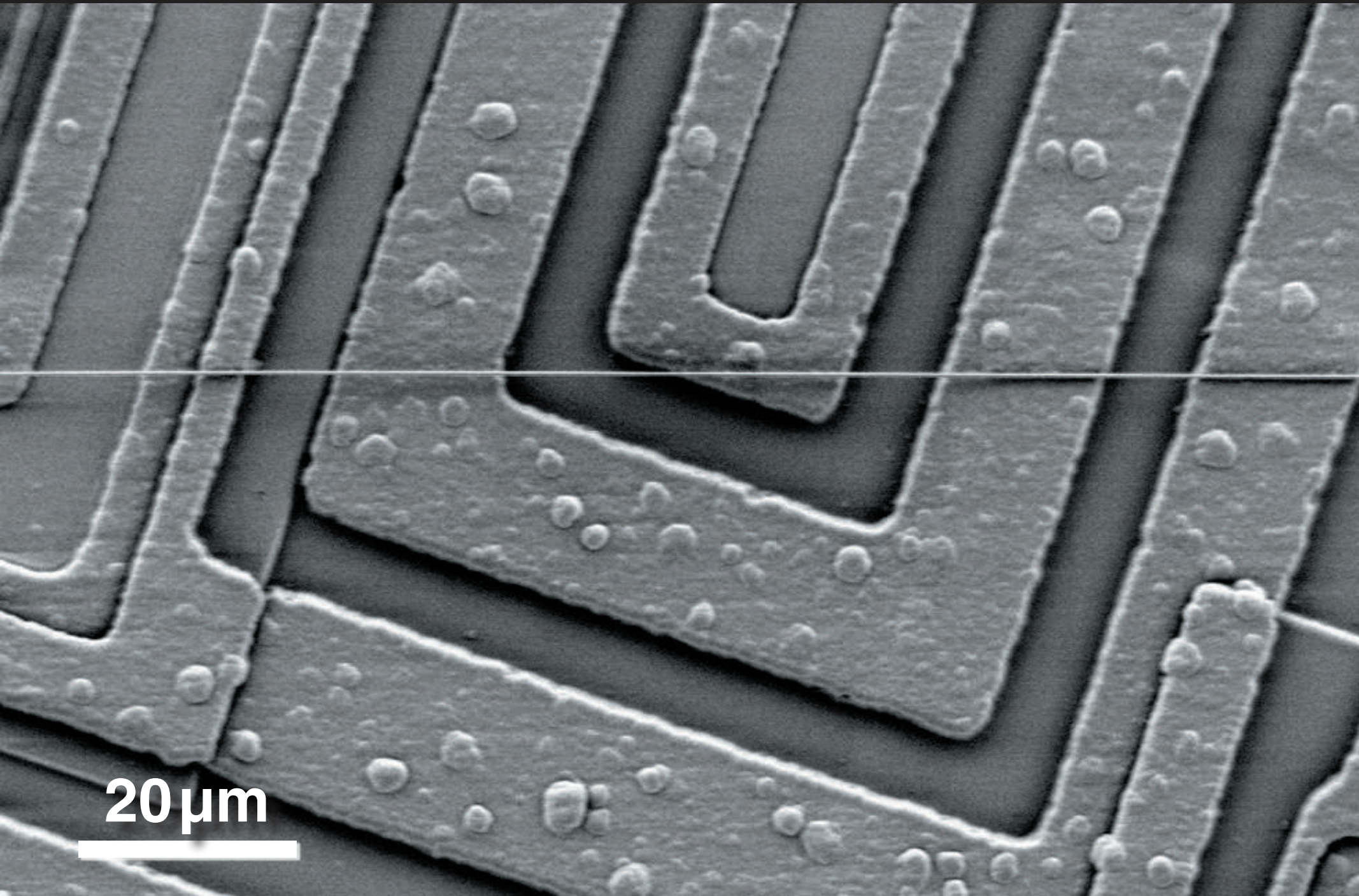

20 μm

Nanowire fabrication

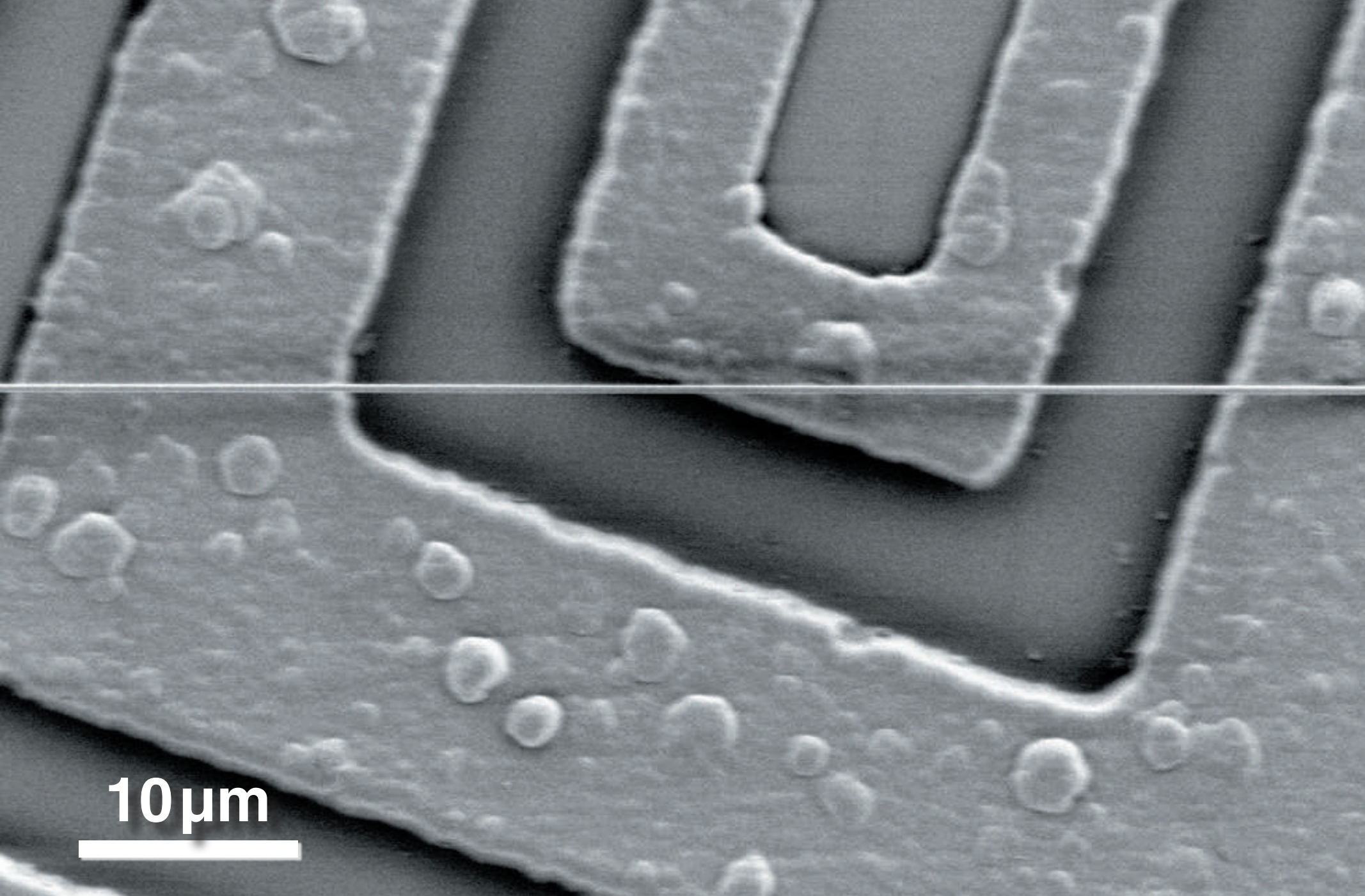

10 μm

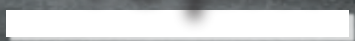

Nanowire fabrication

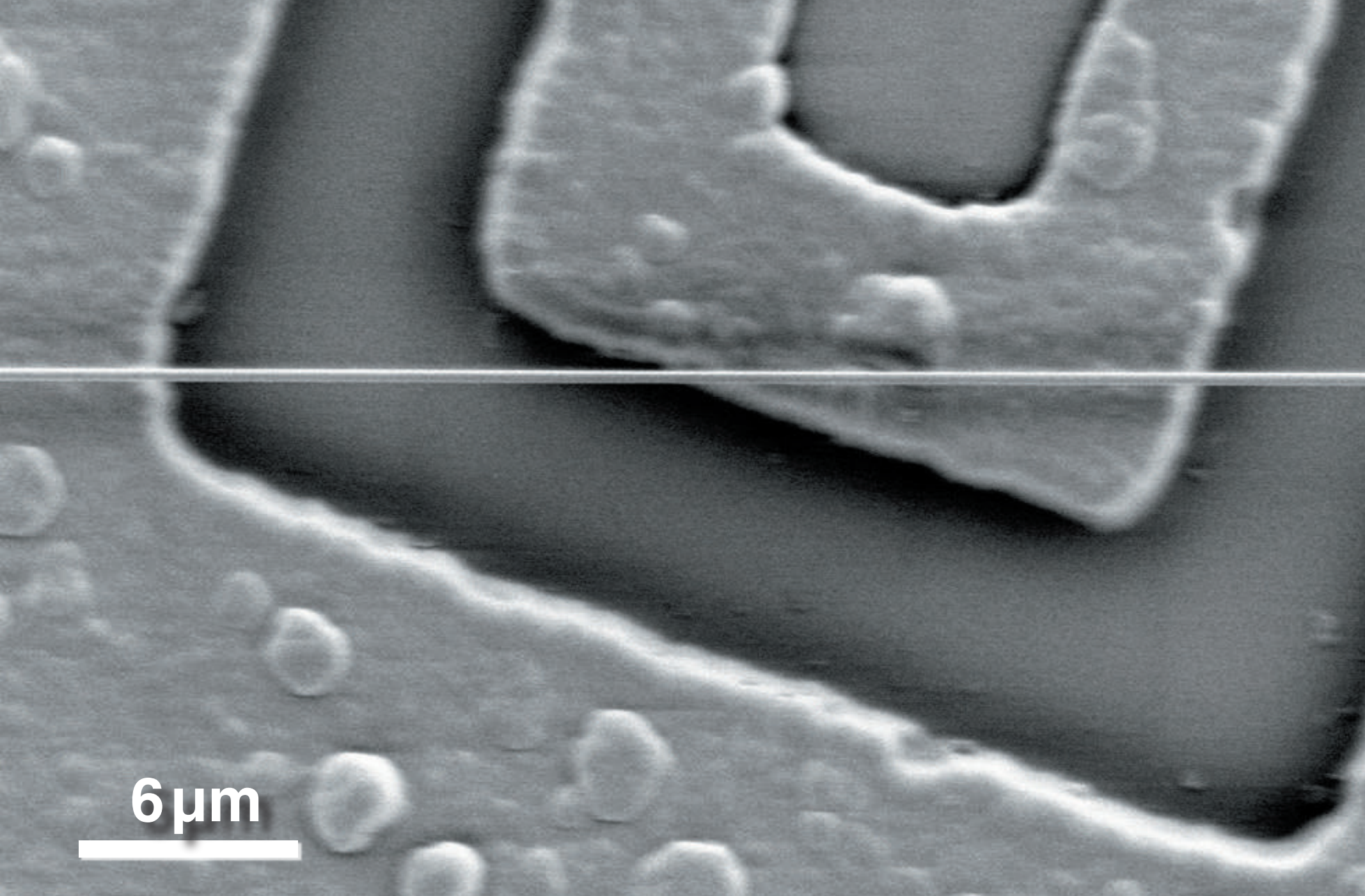

6 μm



Nanowire fabrication

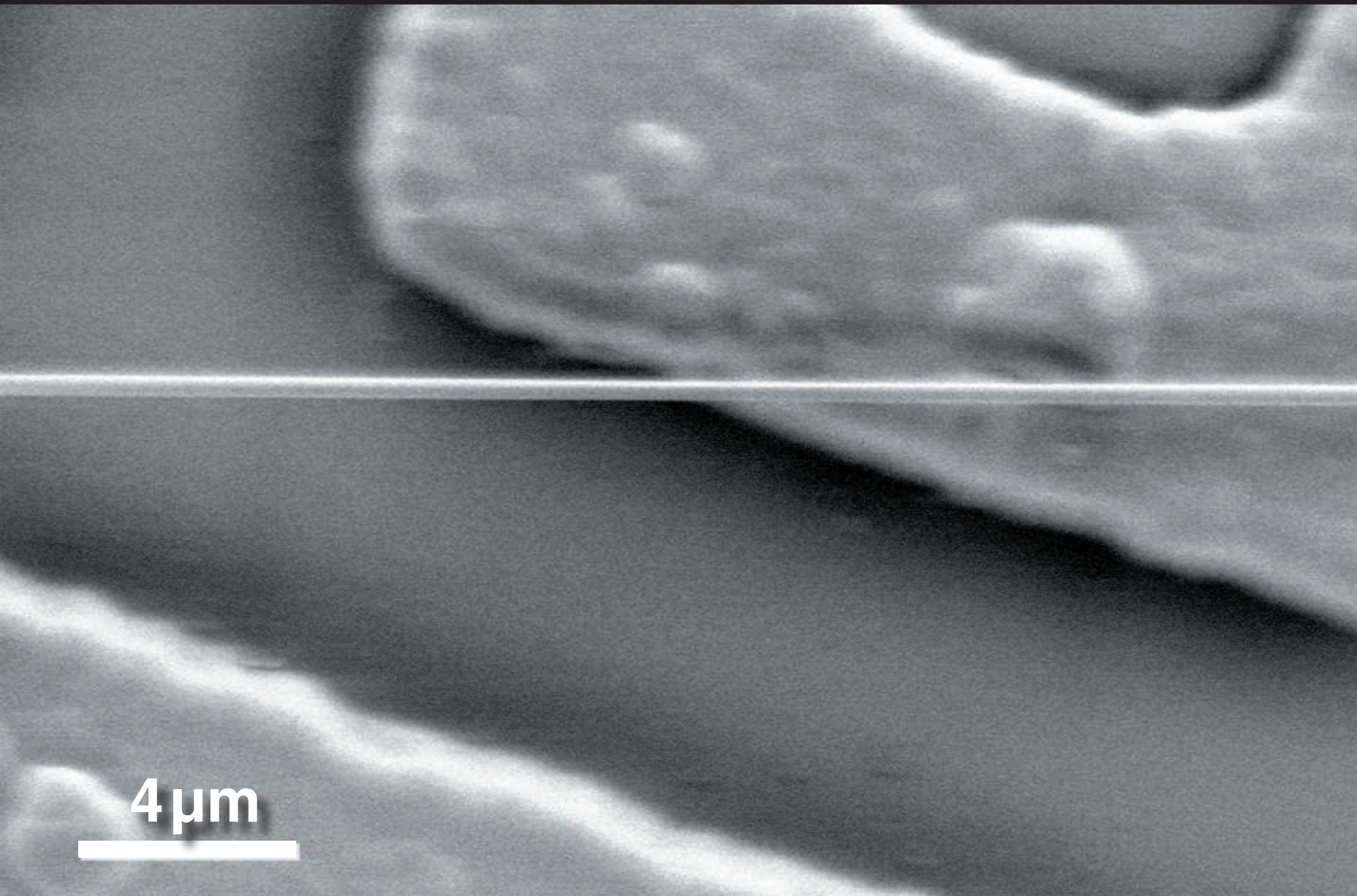

4 μm



Nanowire fabrication

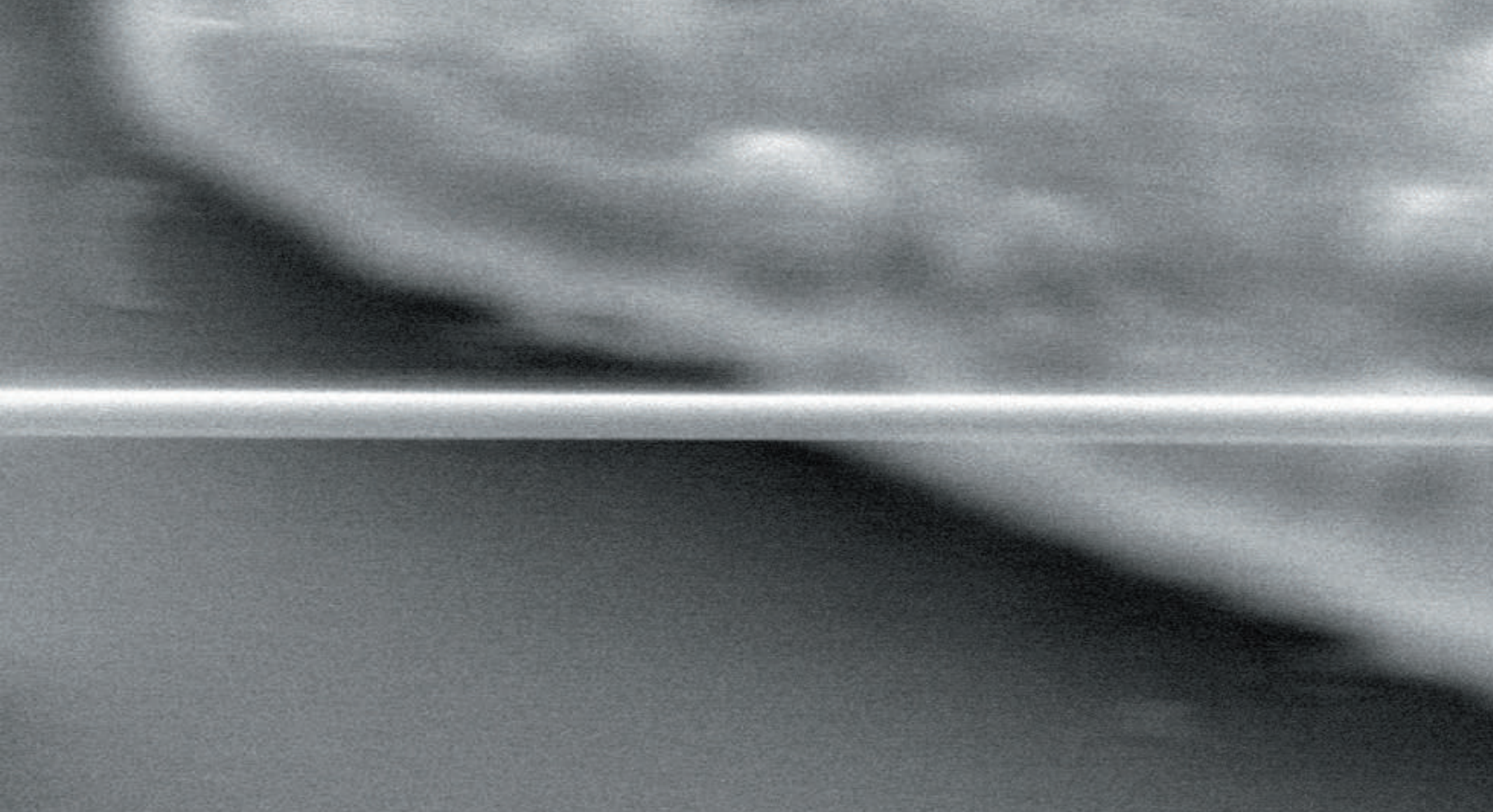

2 μm

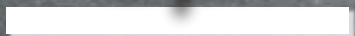

Nanowire fabrication

312 nm

A transmission electron micrograph (TEM) showing a single nanowire. The nanowire is a bright, horizontal line against a dark background. A vertical white line with a crossbar at the bottom indicates the diameter of the nanowire, which is labeled as 312 nm. The nanowire has a slightly irregular, textured appearance.

1 μm

A white horizontal scale bar located in the bottom left corner of the image, representing a length of 1 micrometer.

Waveguiding

Specifications

| | |
|------------------------------------|--------------------|
| diameter D : | down to 20 nm |
| length L : | up to 90 mm |
| aspect ratio D/L : | up to 10^6 |
| diameter uniformity $\Delta D/L$: | 2×10^{-6} |

Nanowire fabrication

$d = 260 \text{ nm}$

$L = 4 \text{ mm}$

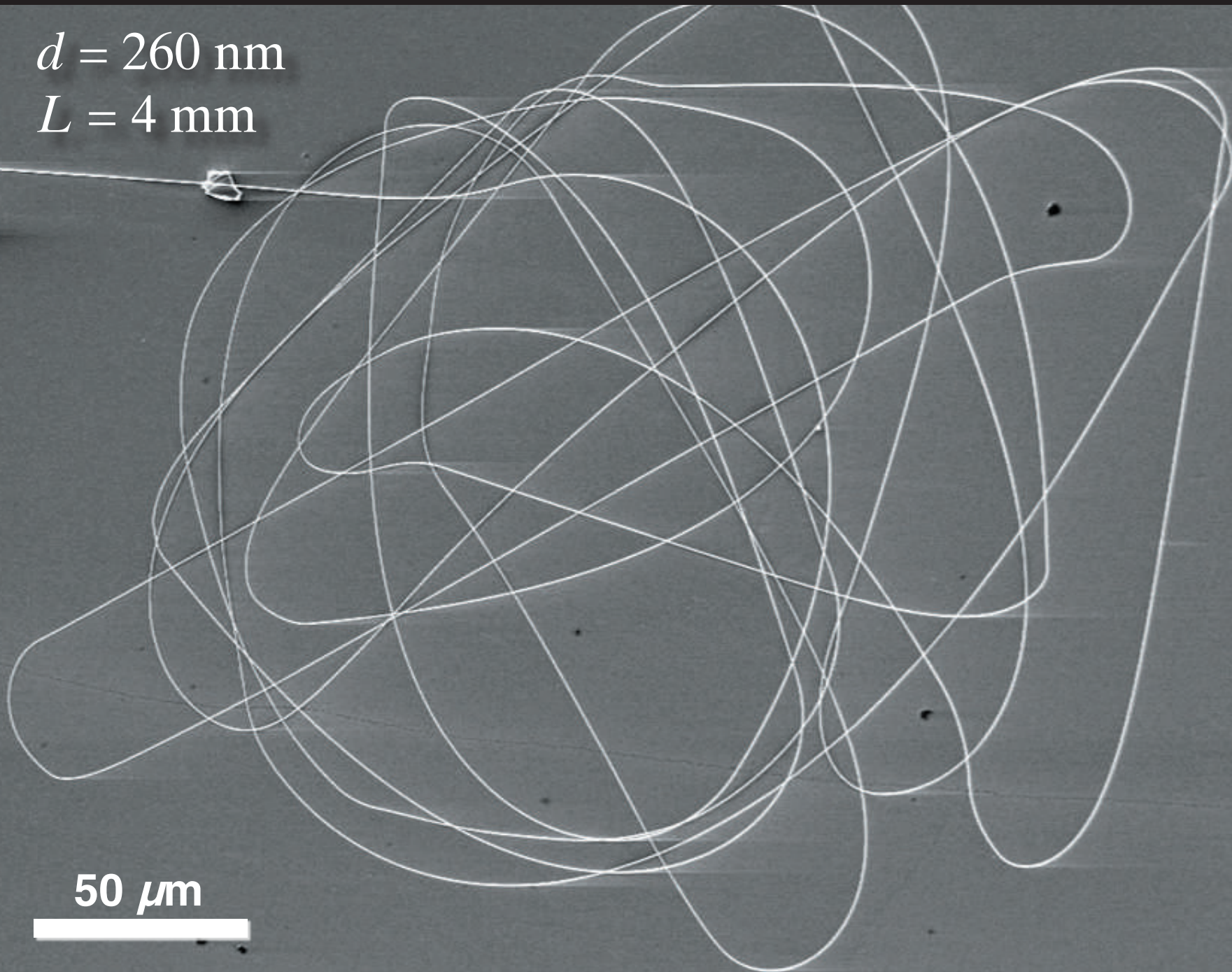

Nanowire fabrication

240-nm wire

200 nm



Nanowire fabrication

RMS roughness < 0.5 nm

20 nm



Nanowire fabrication

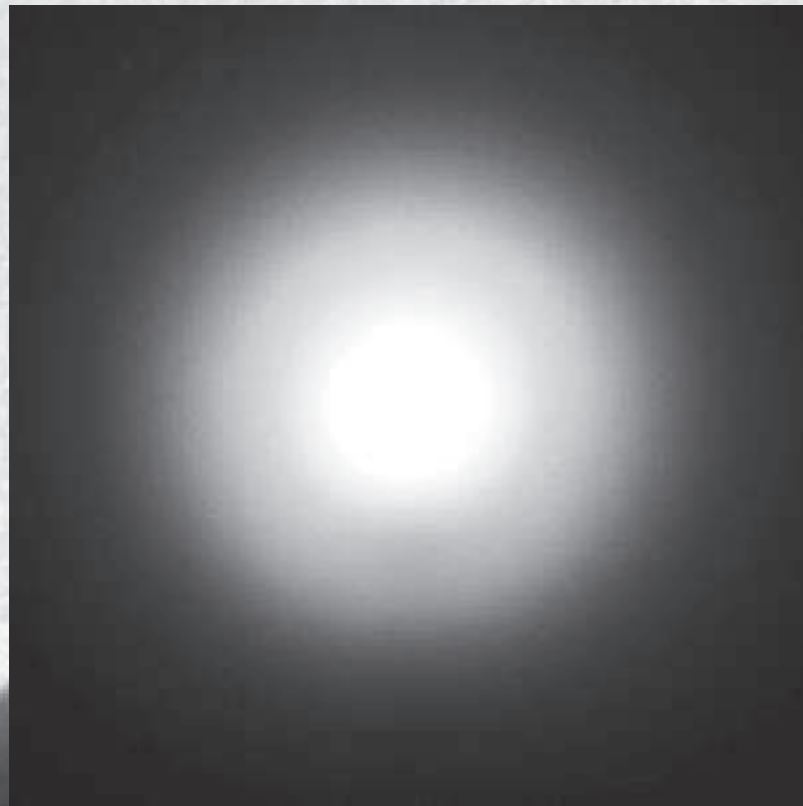

20 nm



Nanowire fabrication

measure tensile stress
at breaking point



Nanowire fabrication

bend to
breaking point

50 μm

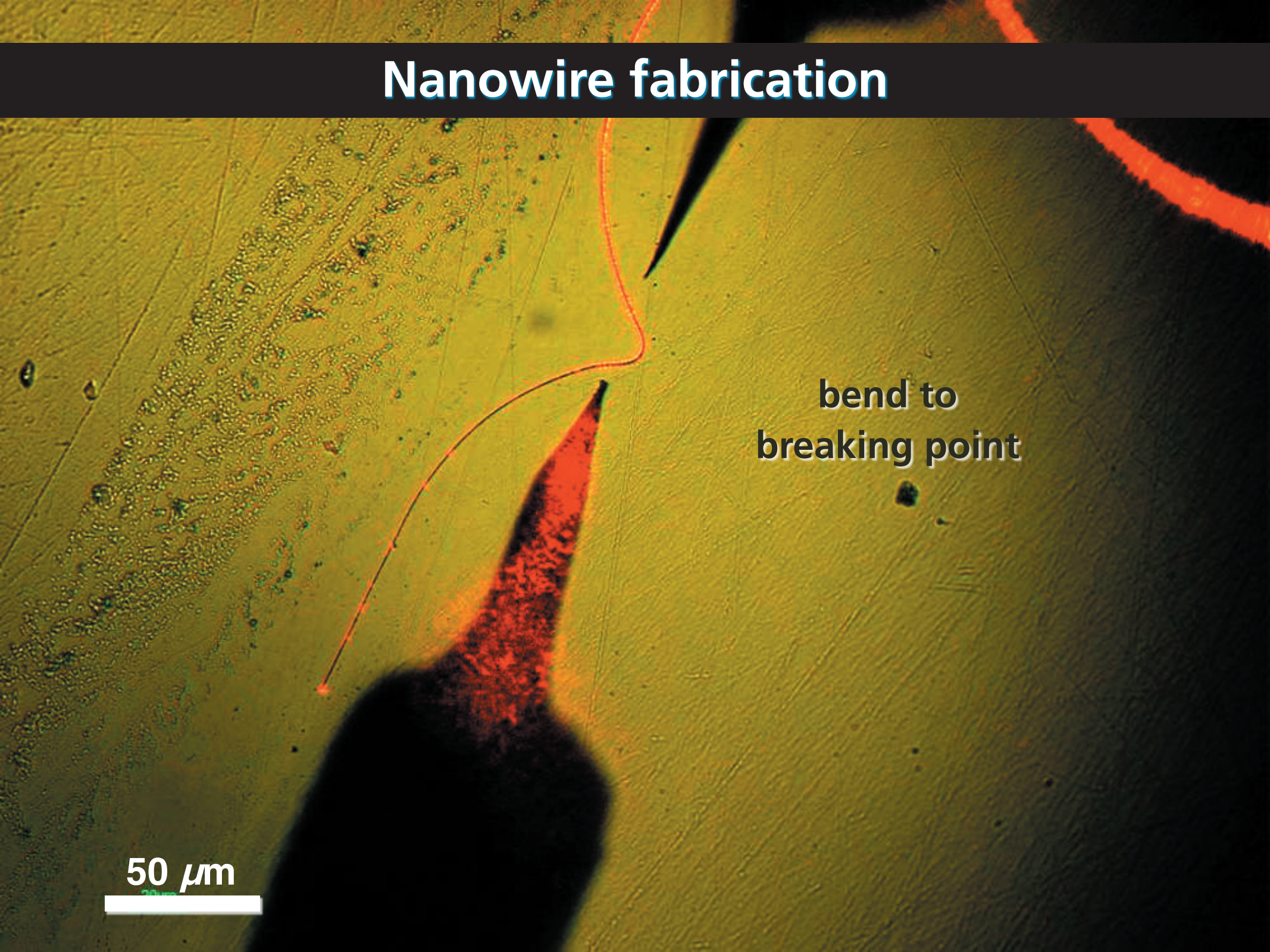

Nanowire fabrication

bend to
breaking point

50 μm

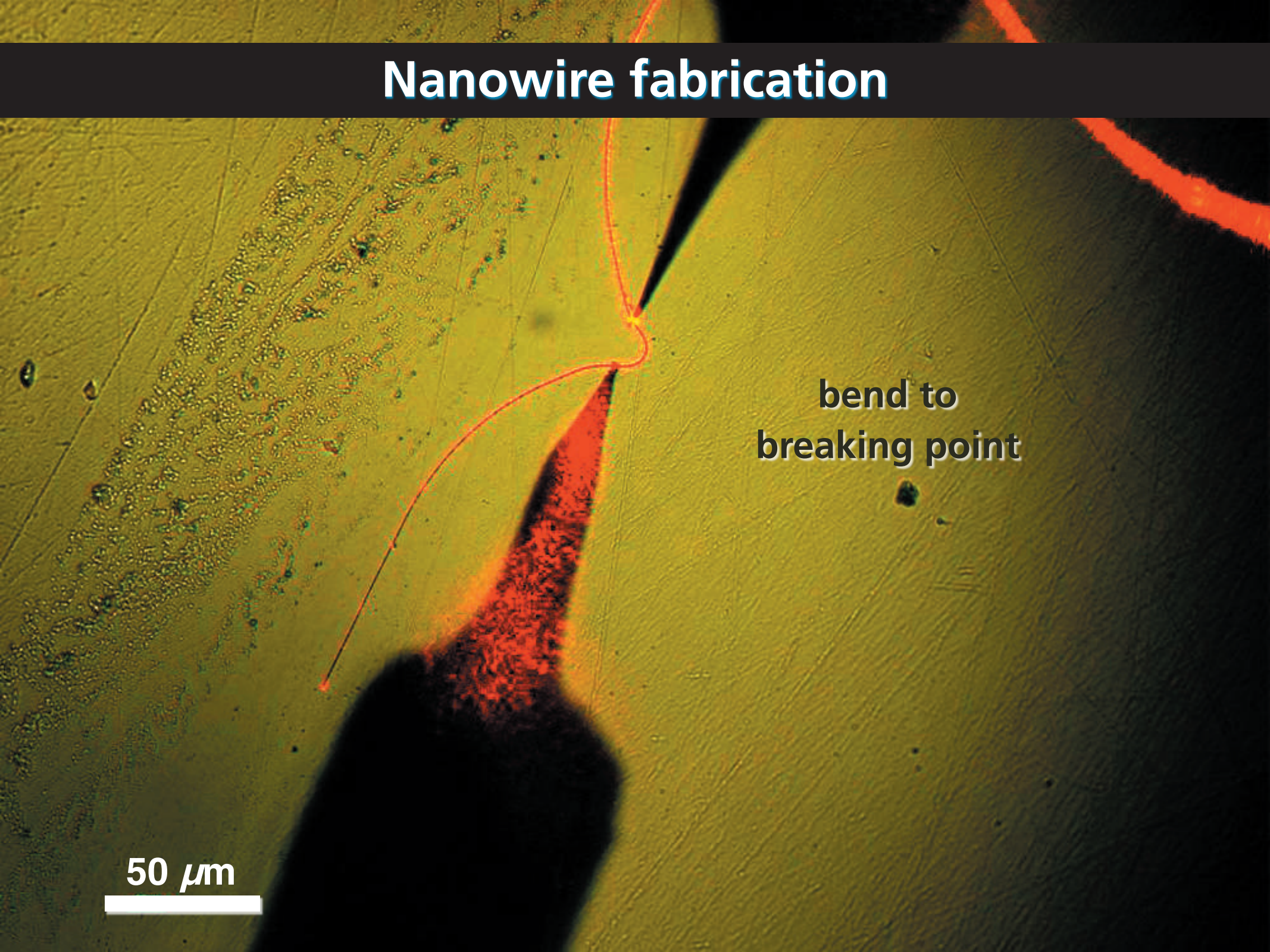

Nanowire fabrication

bend to
breaking point

50 μm

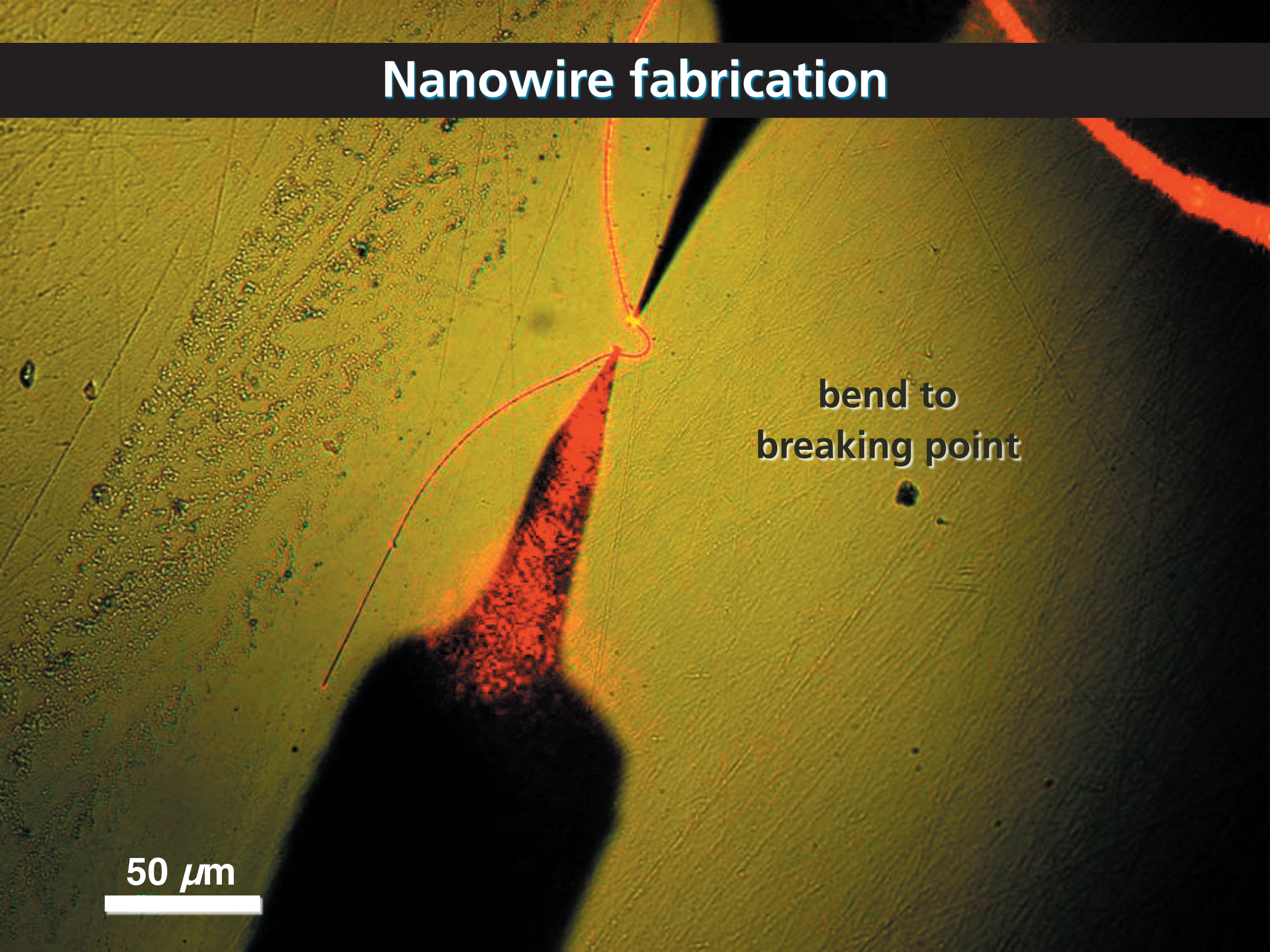

Nanowire fabrication



minimum bending radius R_{EB}
gives tensile stress:

$$\sigma = \frac{ED}{2R_{EB}}$$

E = Young's modulus

D = wire diameter

Waveguiding

tensile strength

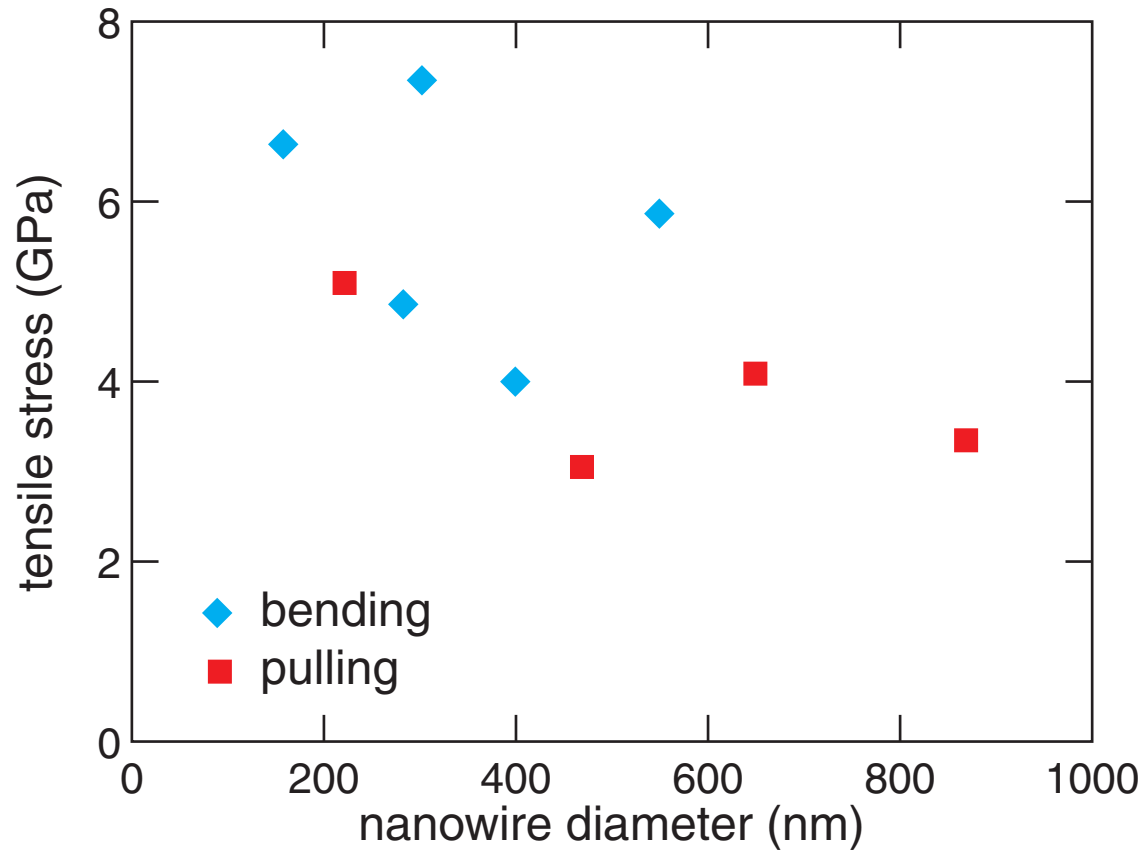

Nanowire fabrication

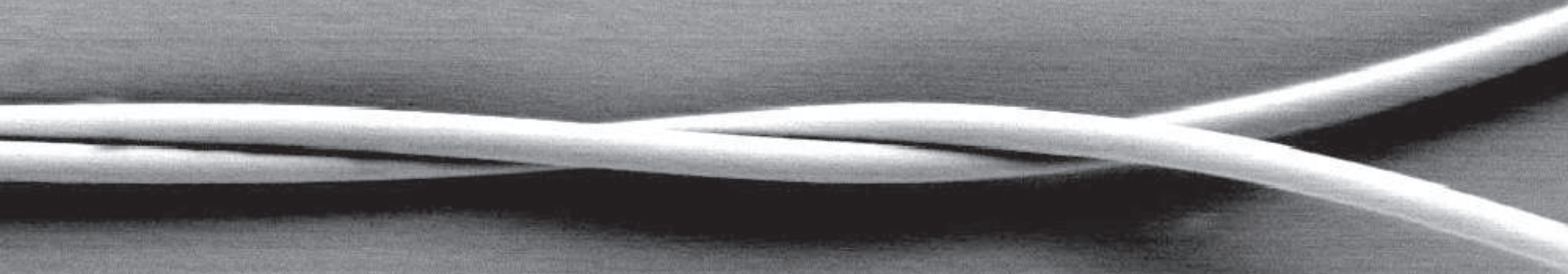

2 μm



Nanowire fabrication

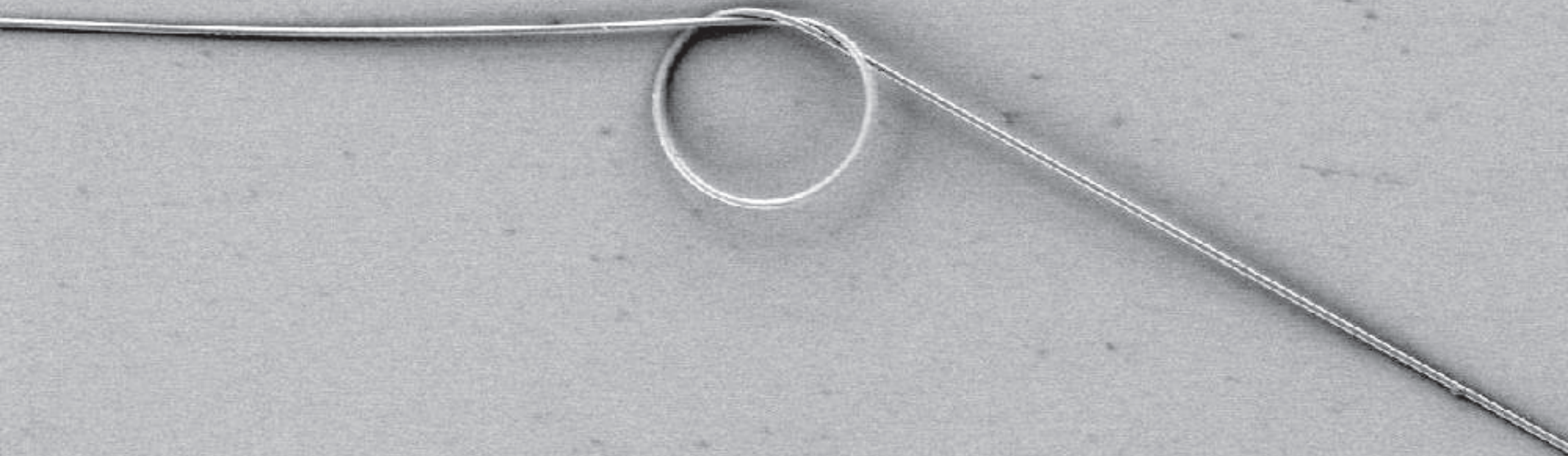

20 μm



Nanowire fabrication

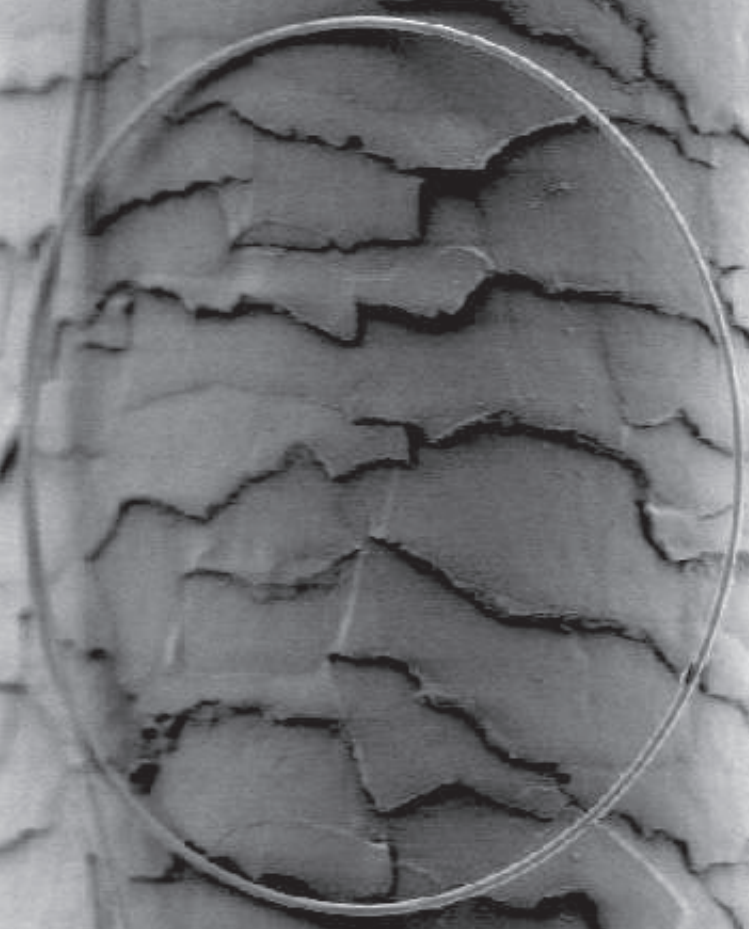

20 μm



Outline

- waveguiding
- nanowire fabrication
- optical properties

Optical properties

coupling light into nanowires

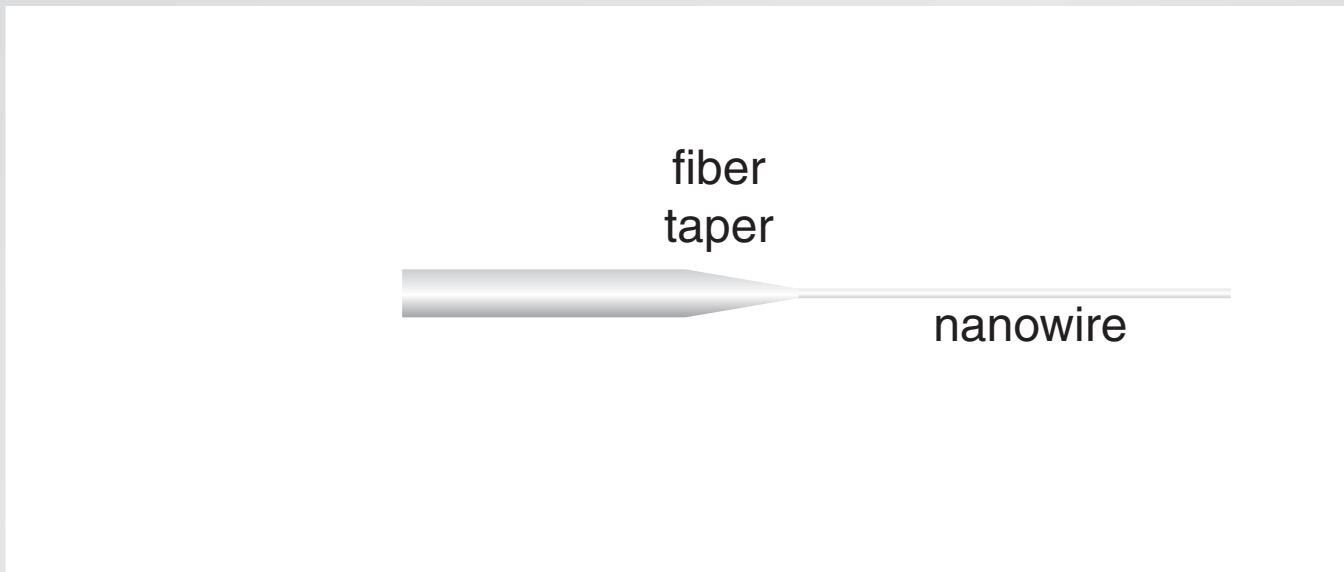

Optical properties

coupling light into nanowires

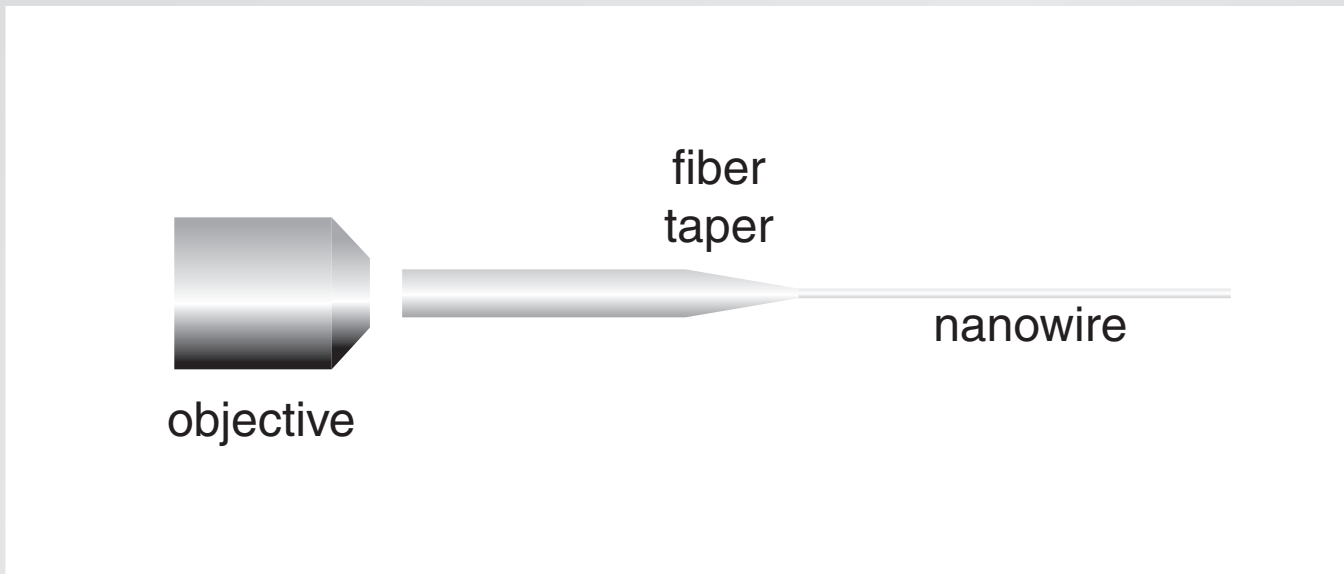

Optical properties

coupling light into nanowires

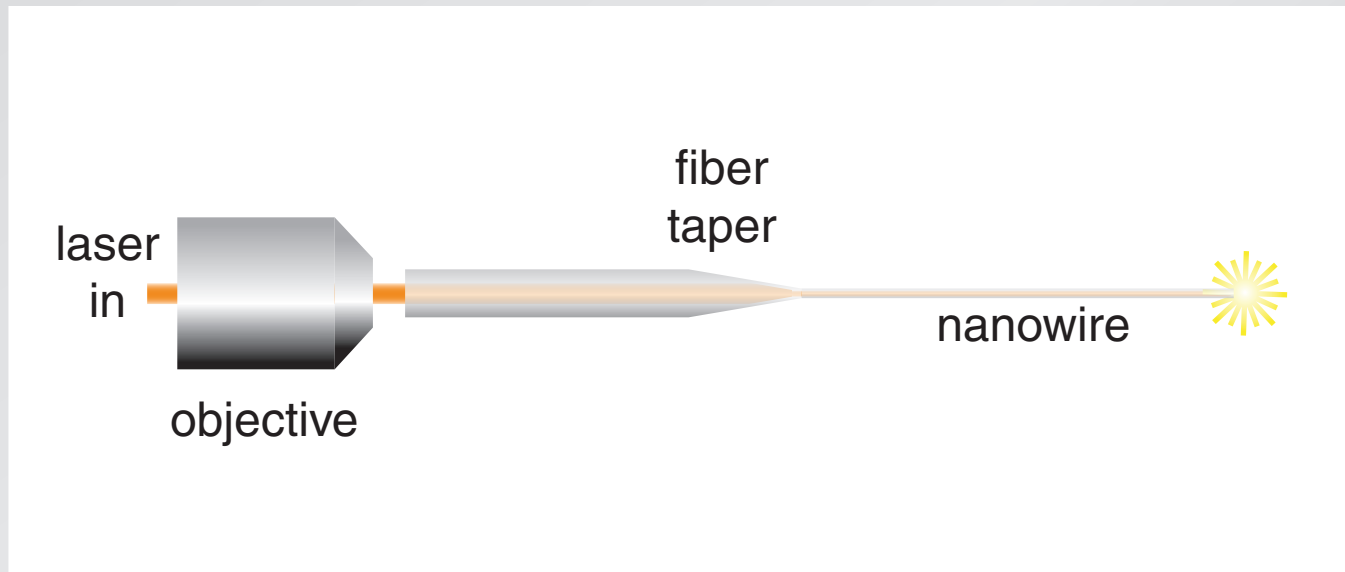

Optical properties

280-nm nanowire



360 nm



450 nm



Optical properties

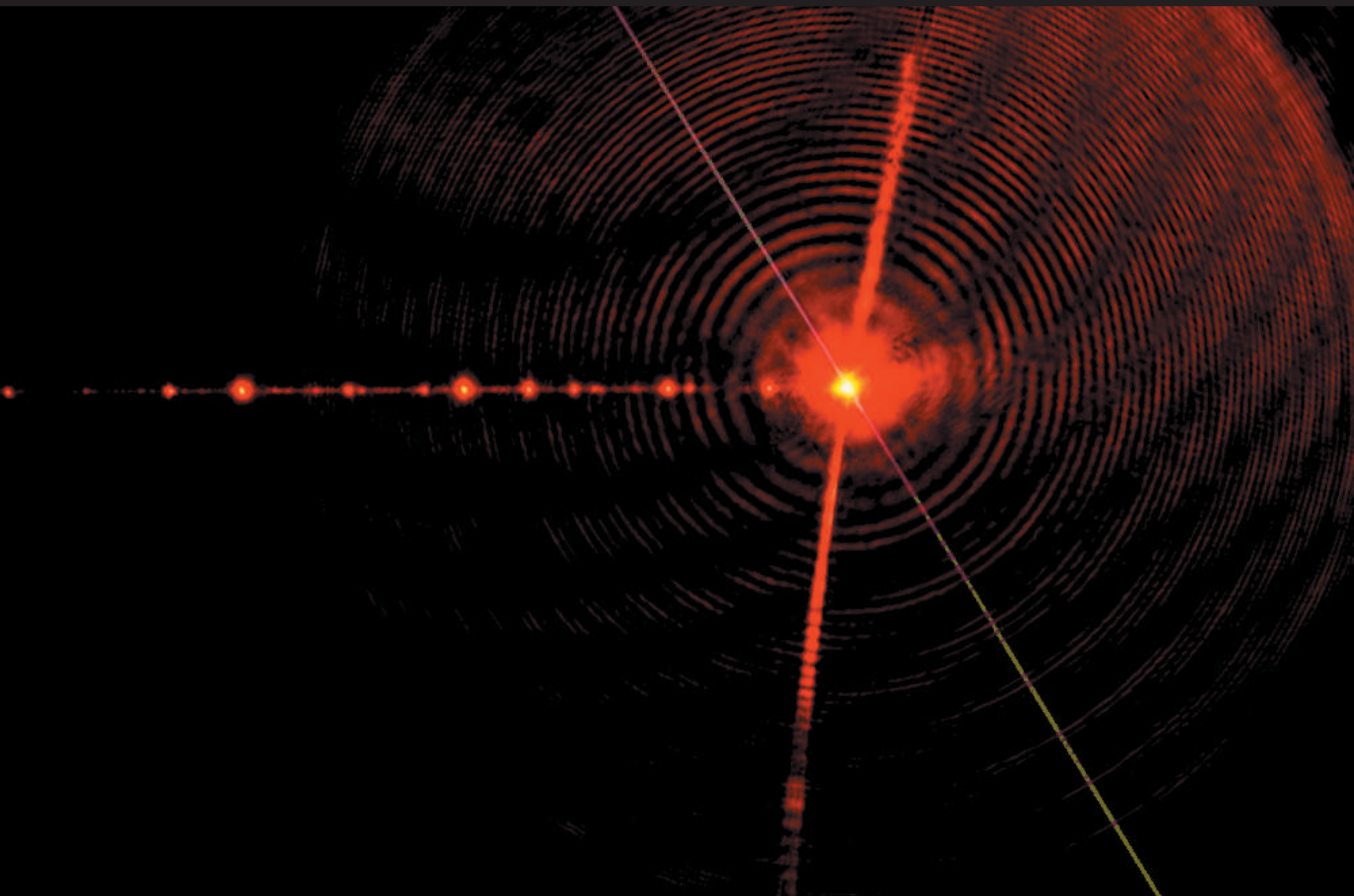

Optical properties



Optical properties

Poynting vector profile for 800-nm nanowire

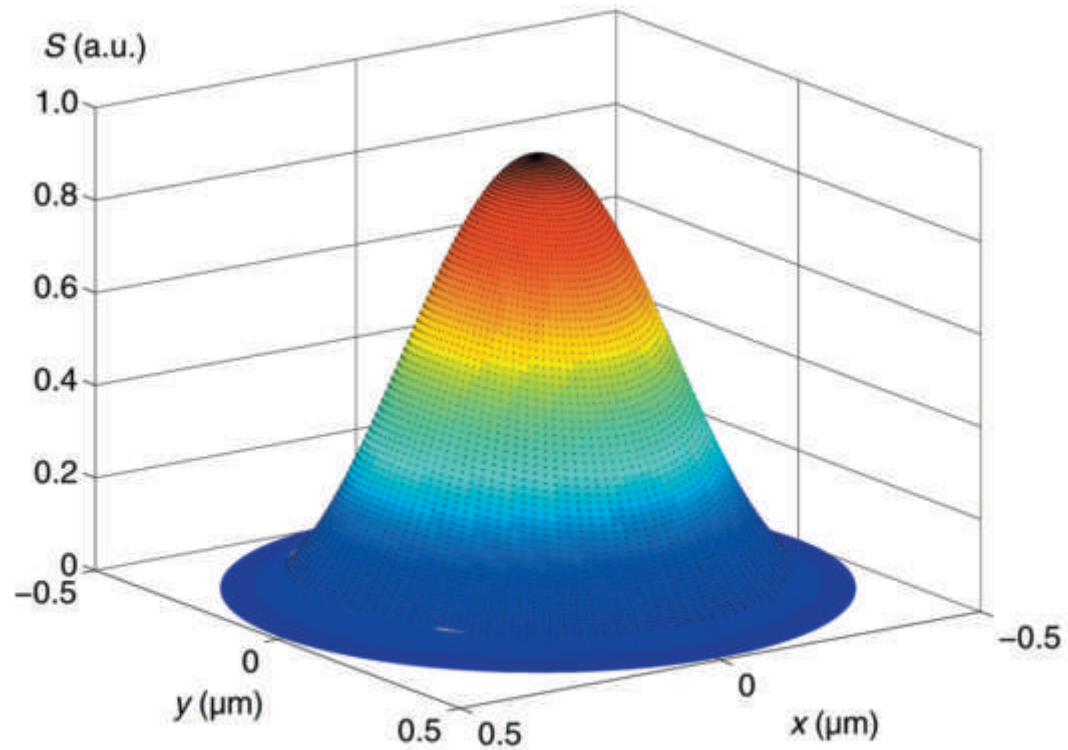

Optical properties

Poynting vector profile for 800-nm nanowire

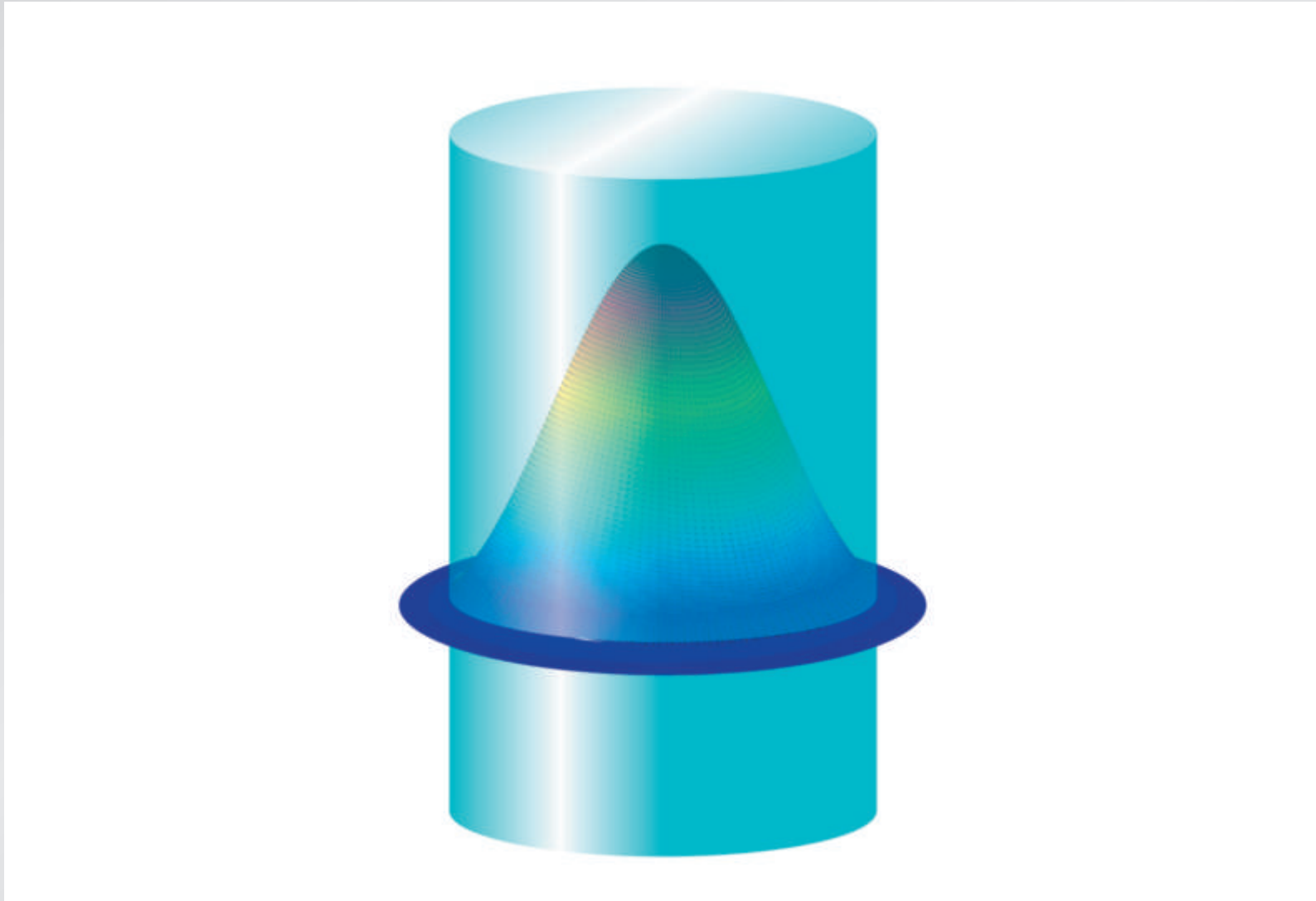

Optical properties

Poynting vector profile for 800-nm nanowire

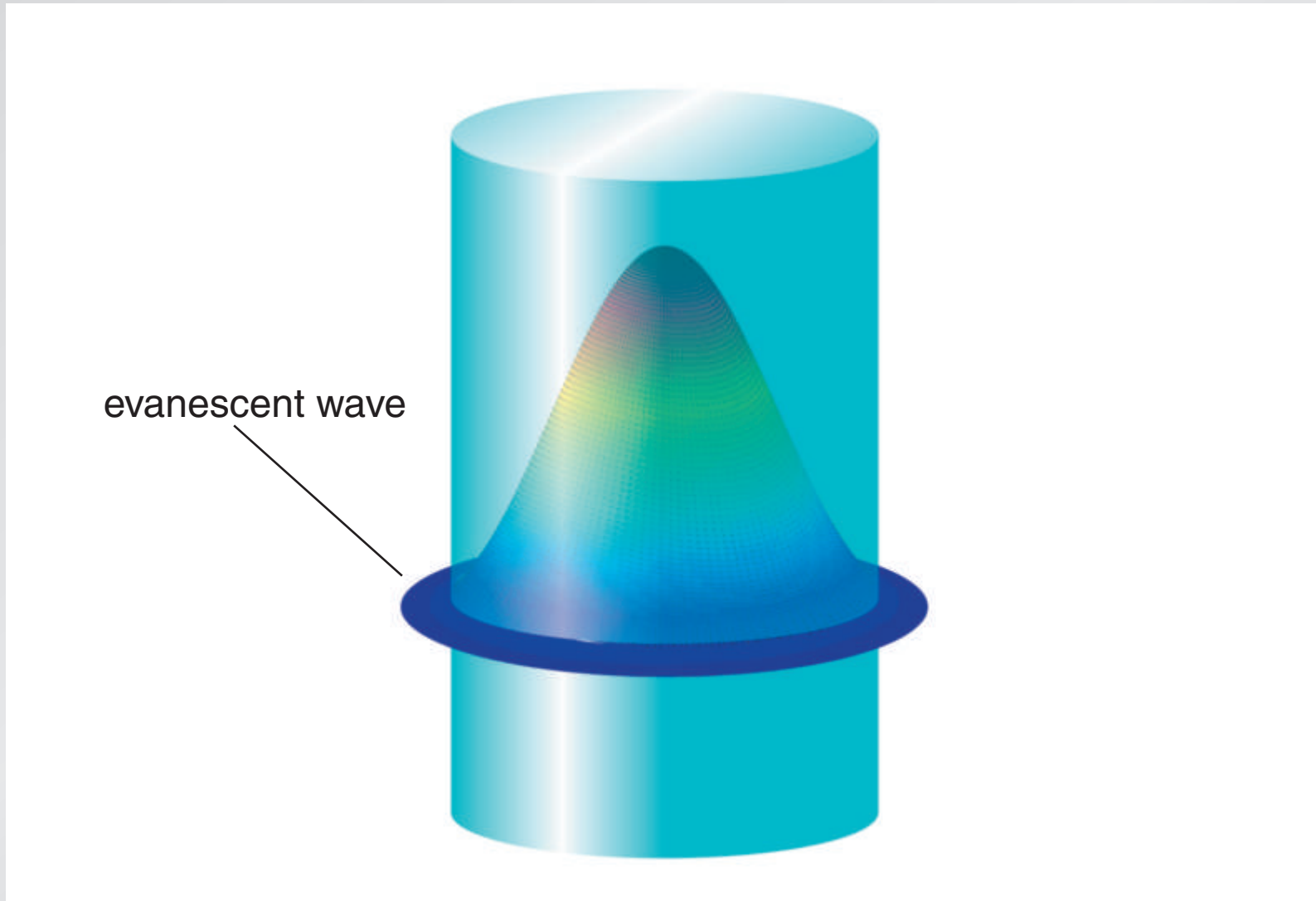

Optical properties

Poynting vector profile for 600-nm nanowire

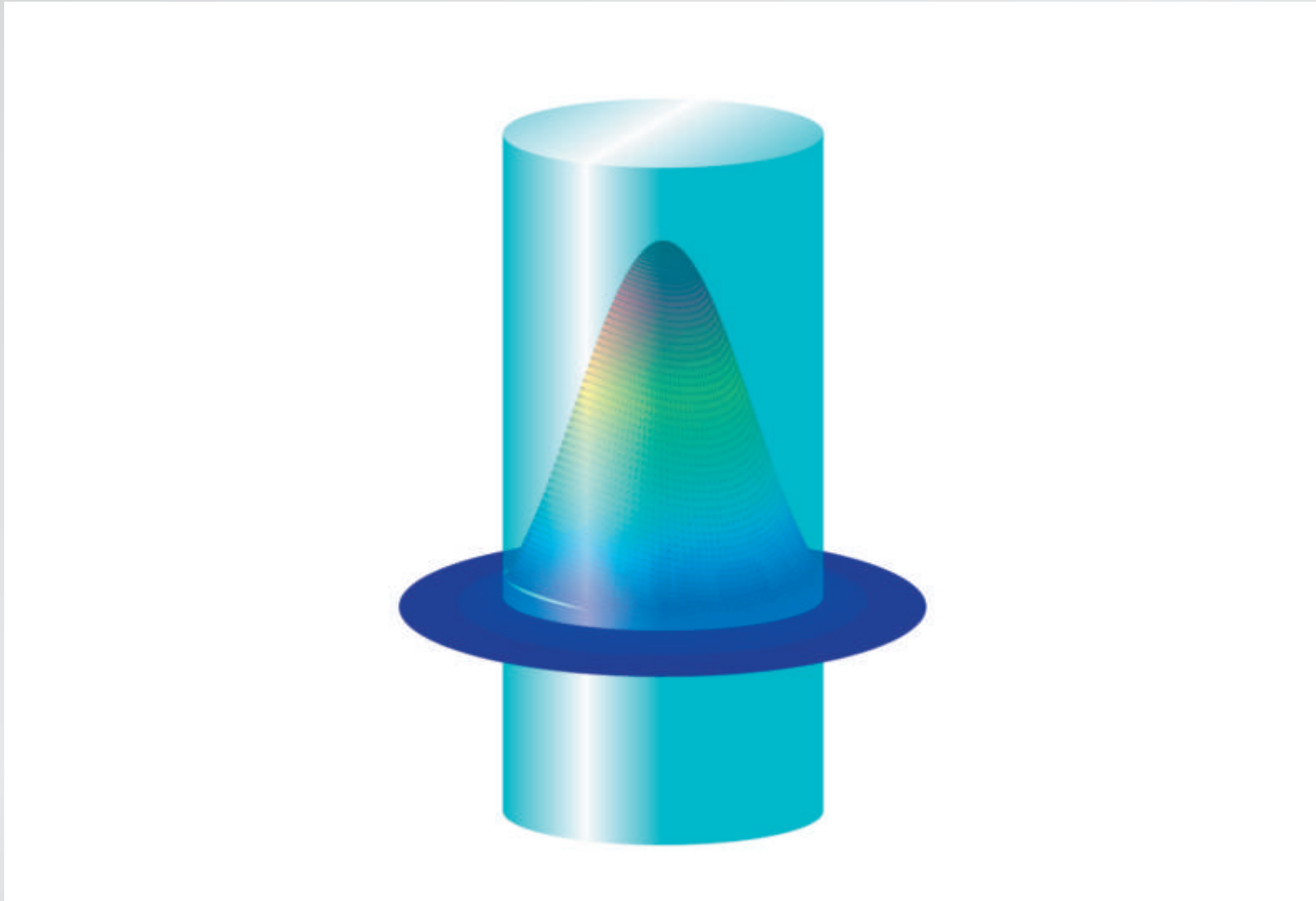

Optical properties

Poynting vector profile for 500-nm nanowire

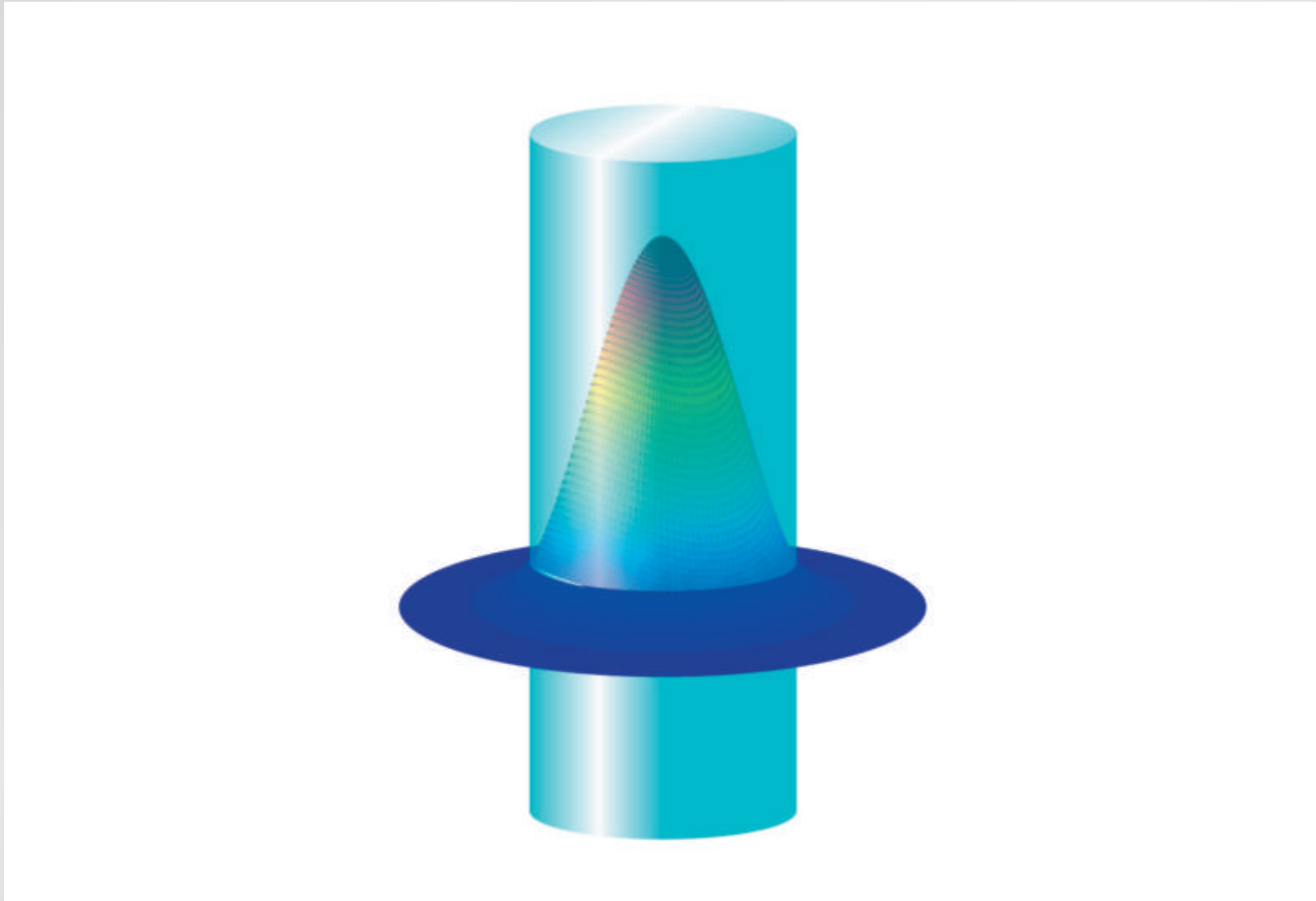

Optical properties

Poynting vector profile for 400-nm nanowire

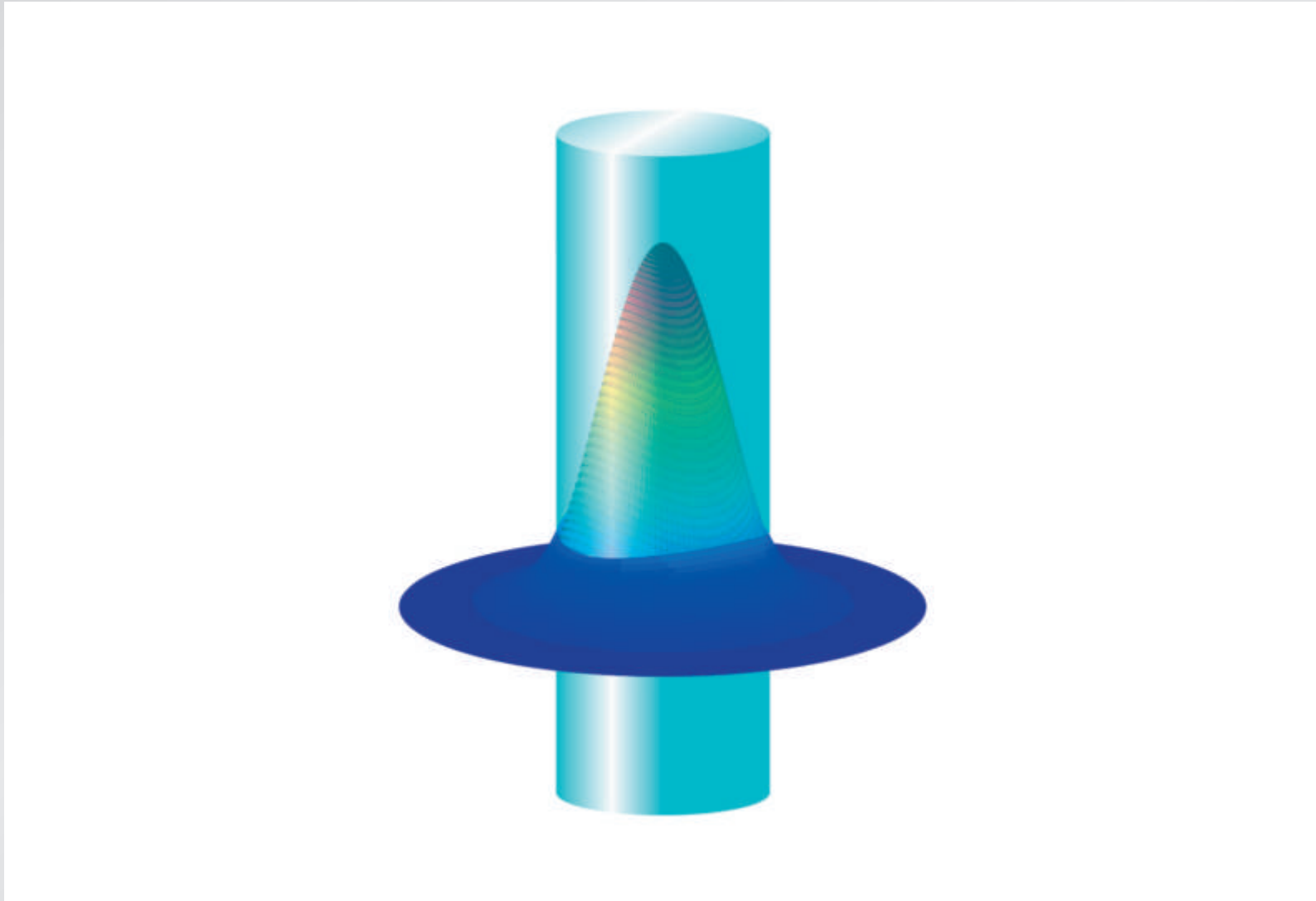

Optical properties

Poynting vector profile for 300-nm nanowire

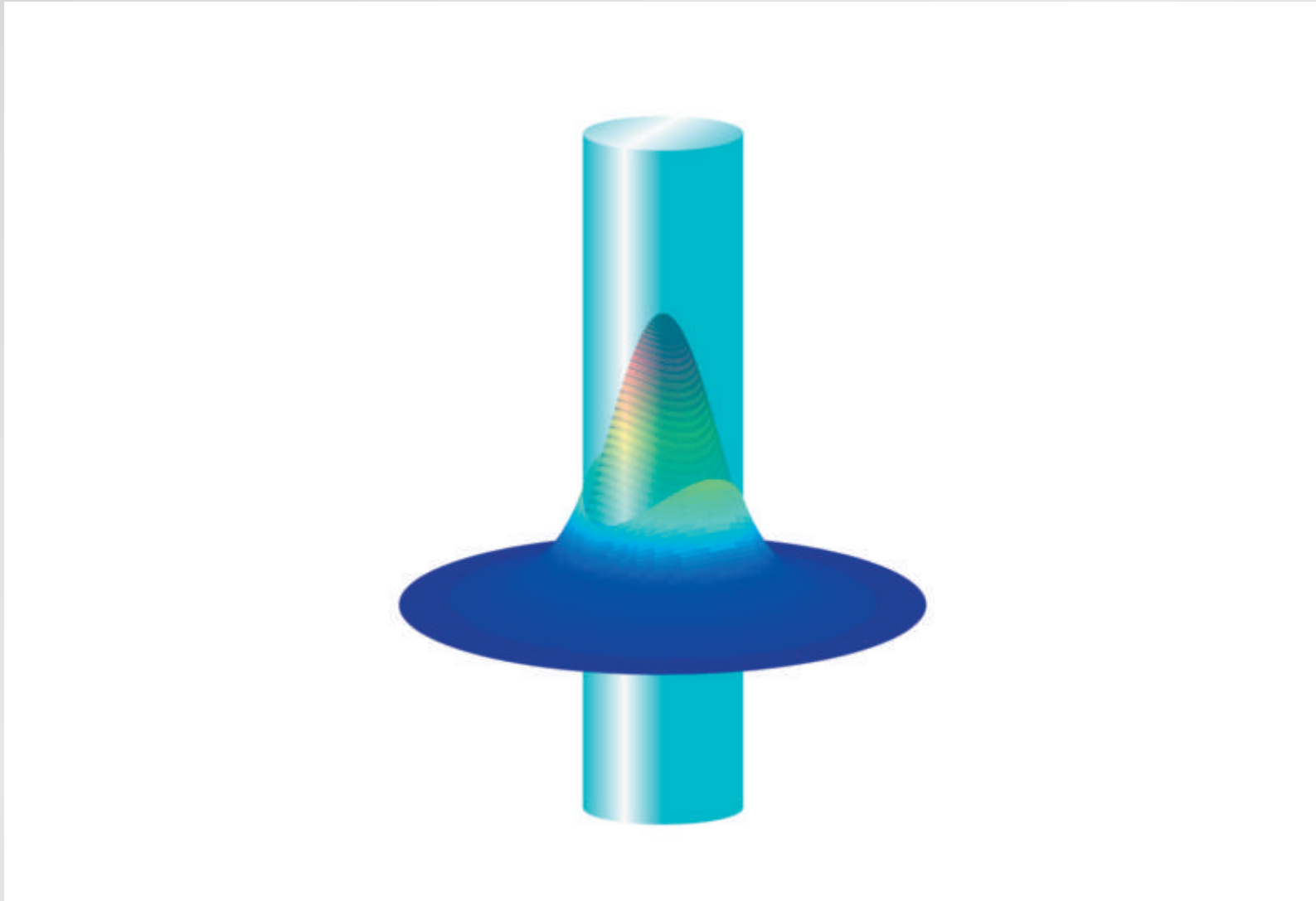

Optical properties

Poynting vector profile for 200-nm nanowire

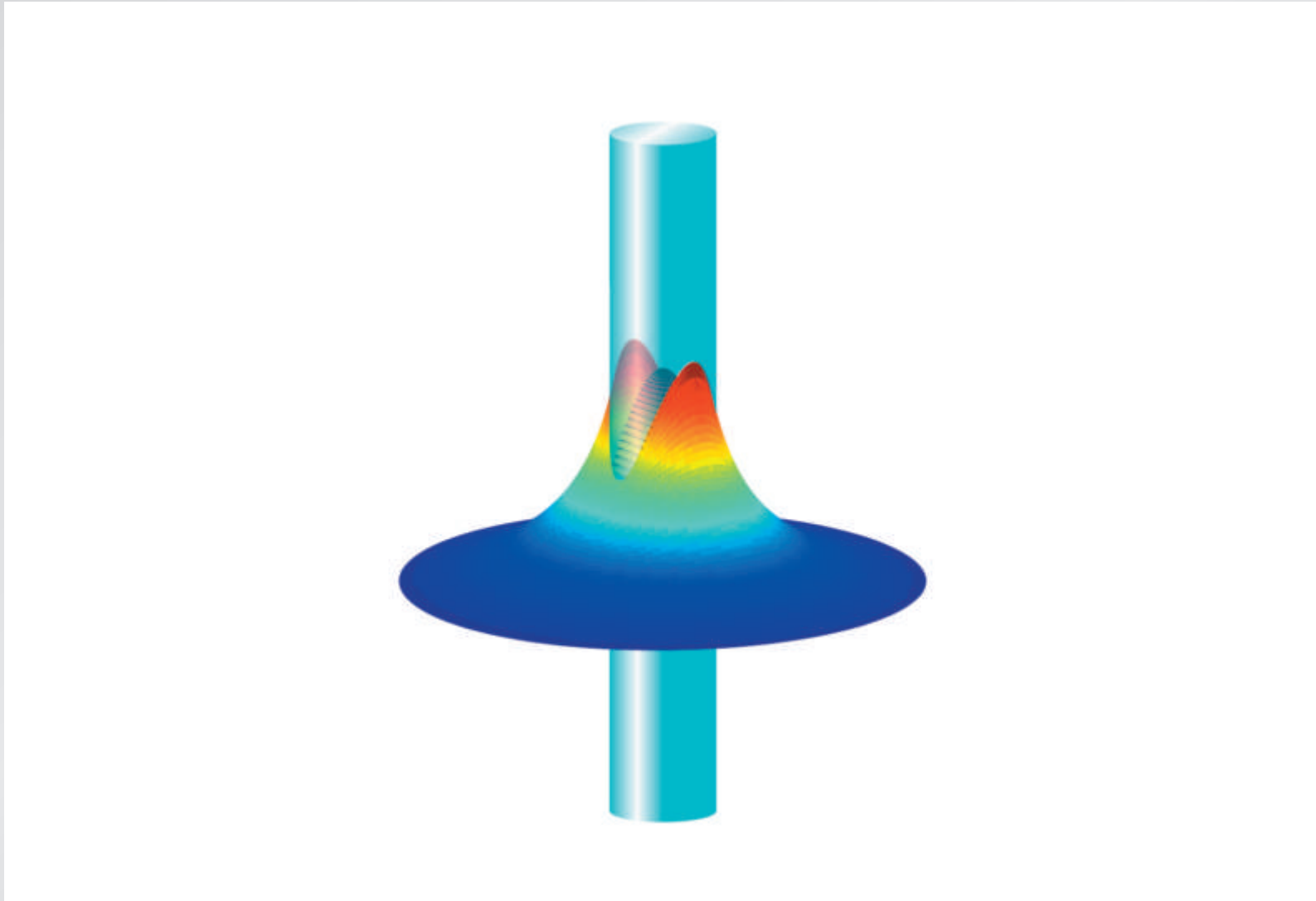

Waveguiding

fraction of power carried in core

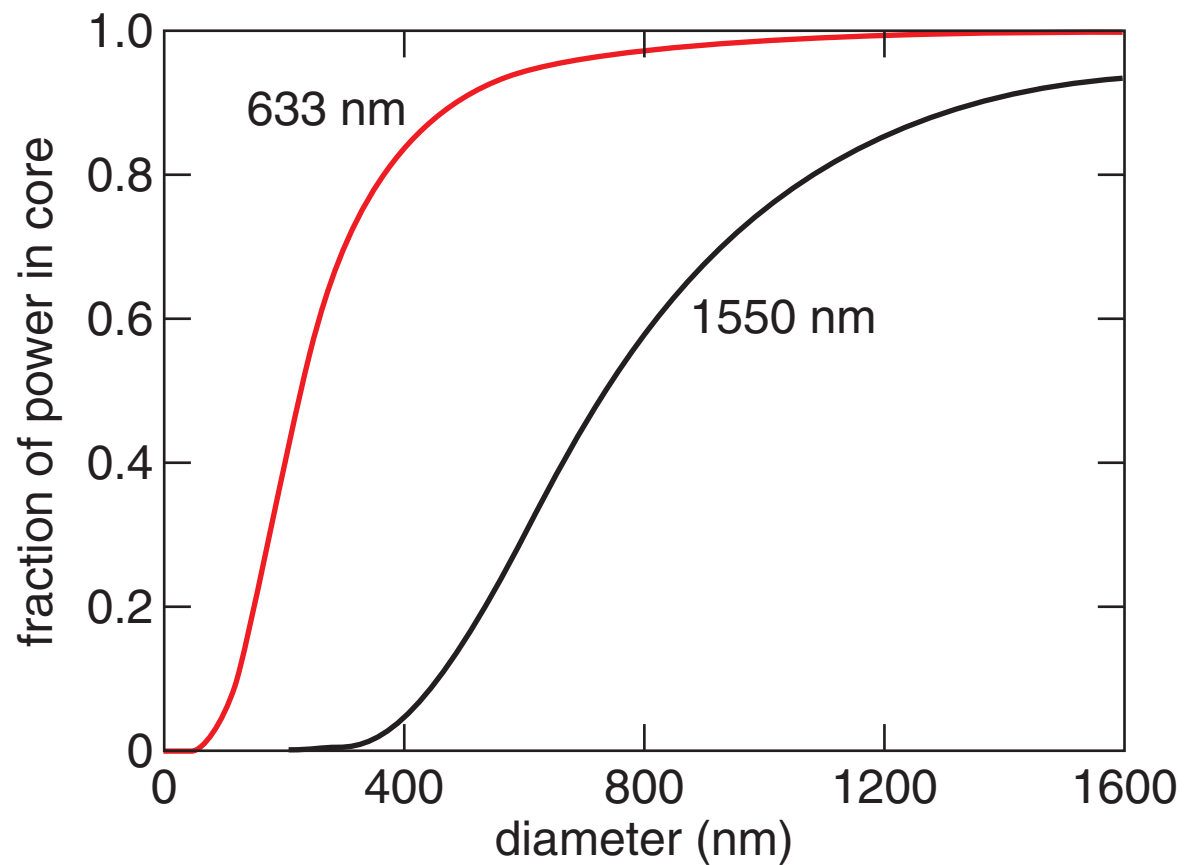

Optical properties

coupling light between nanowires

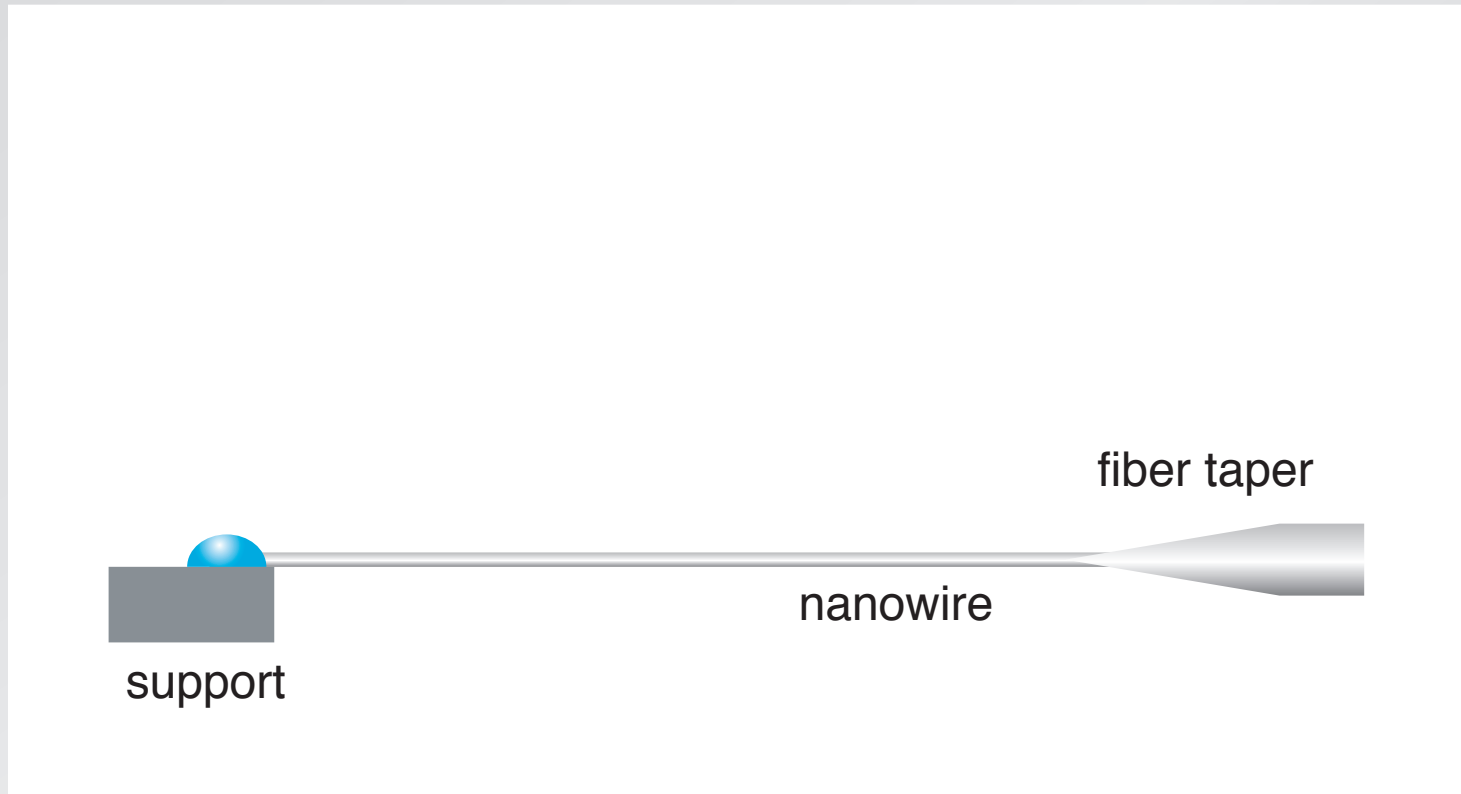

Optical properties

coupling light between nanowires

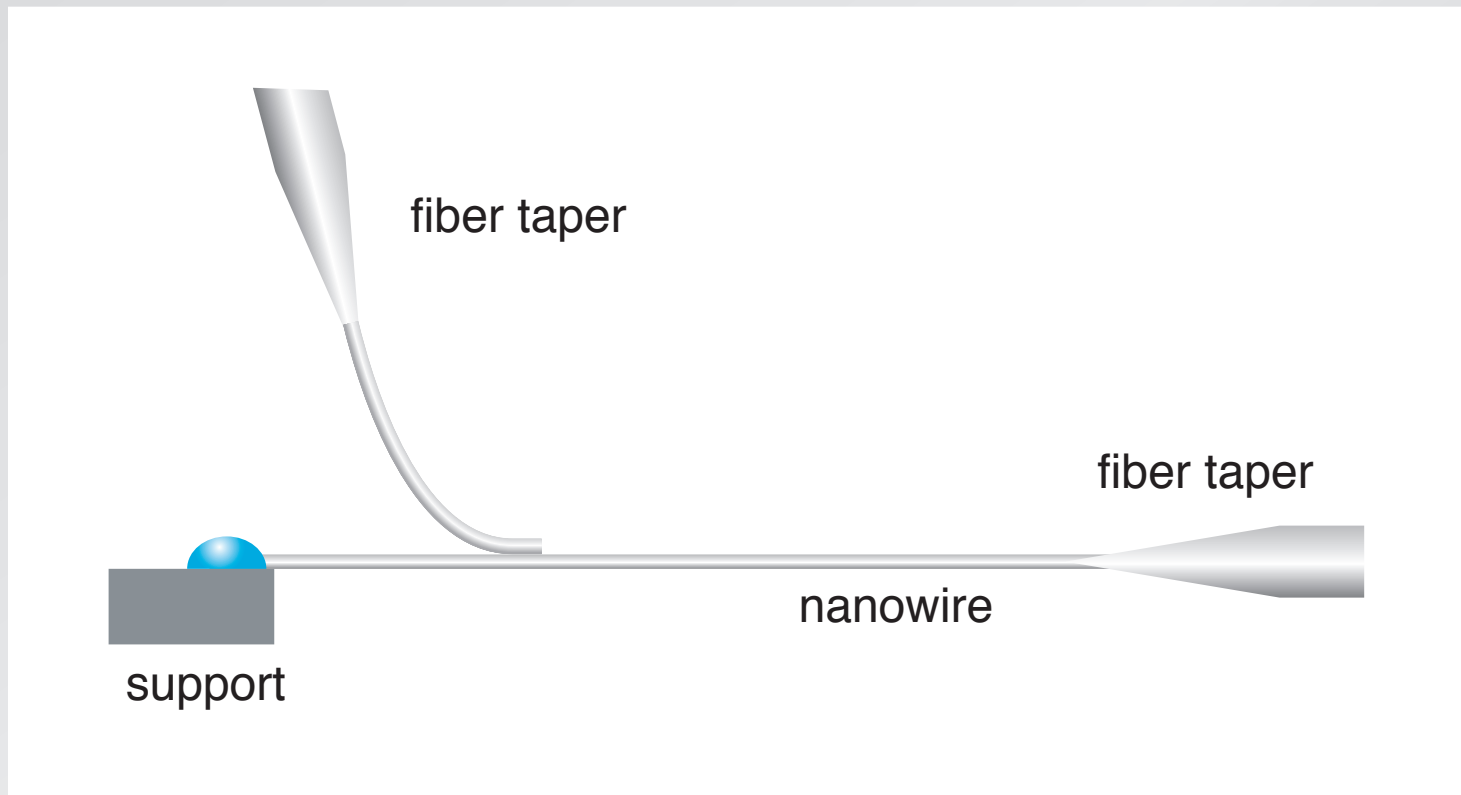

Optical properties

coupling light between nanowires

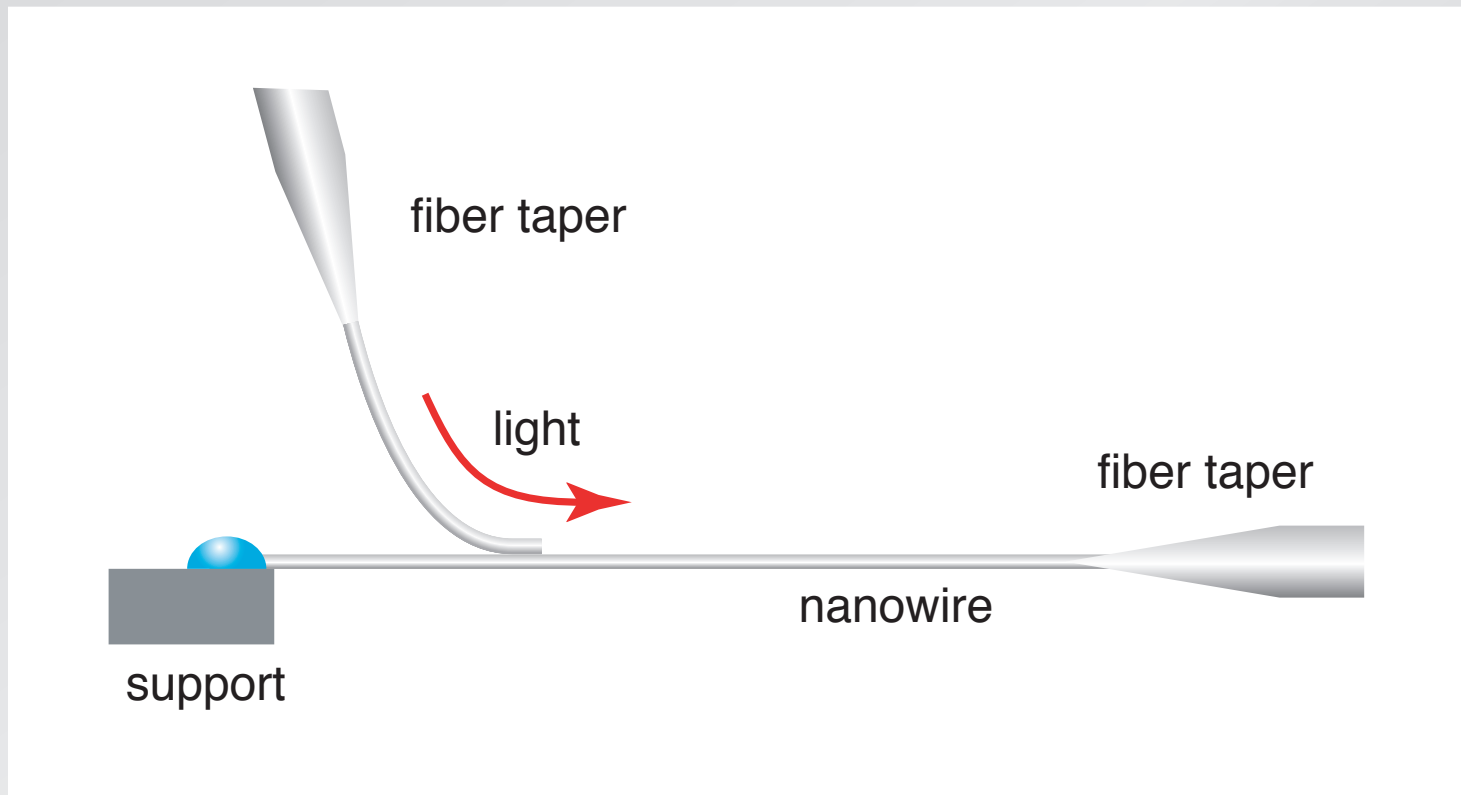

Optical properties

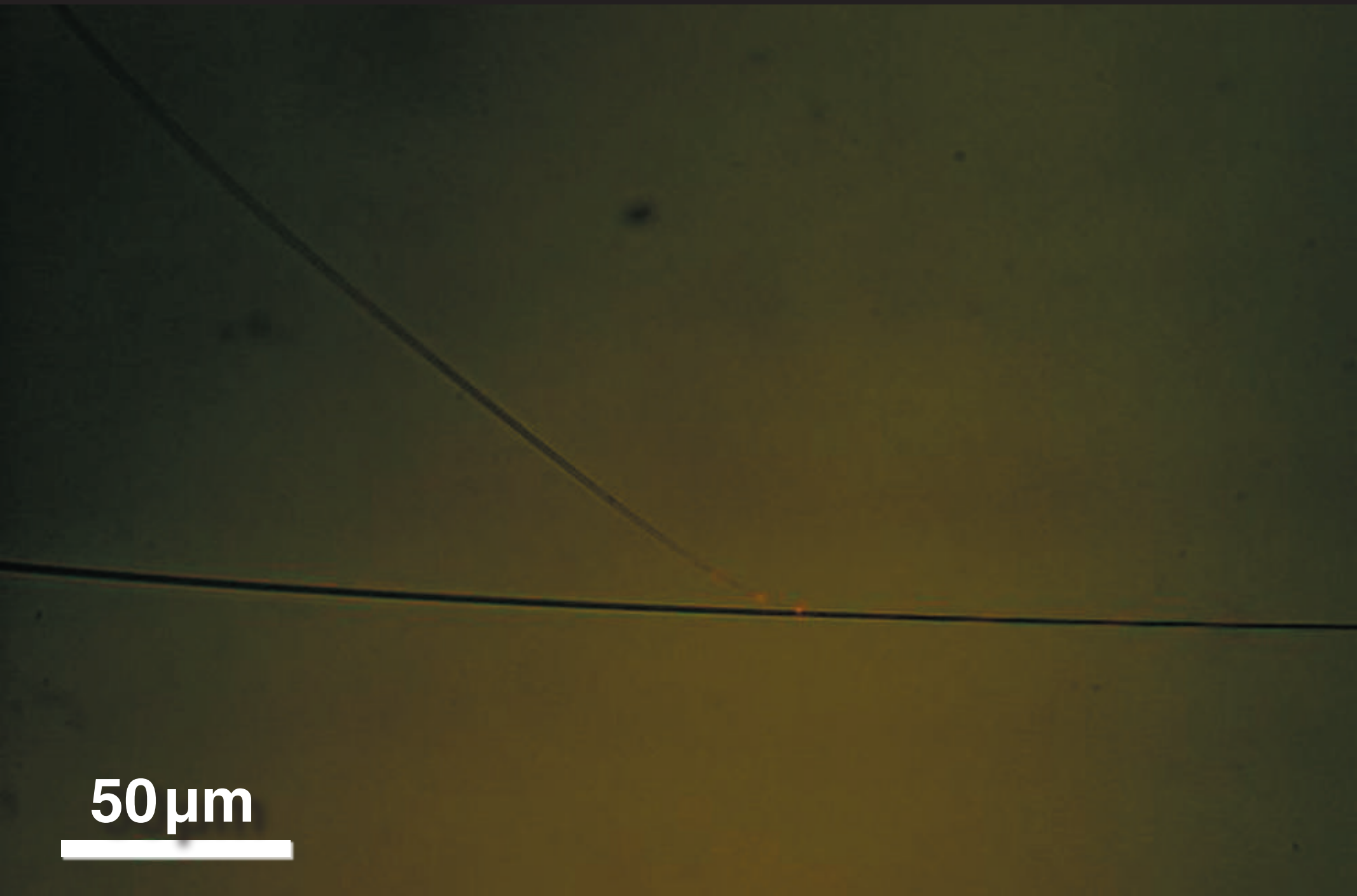

50 μm

Optical properties



50 μm



Optical properties

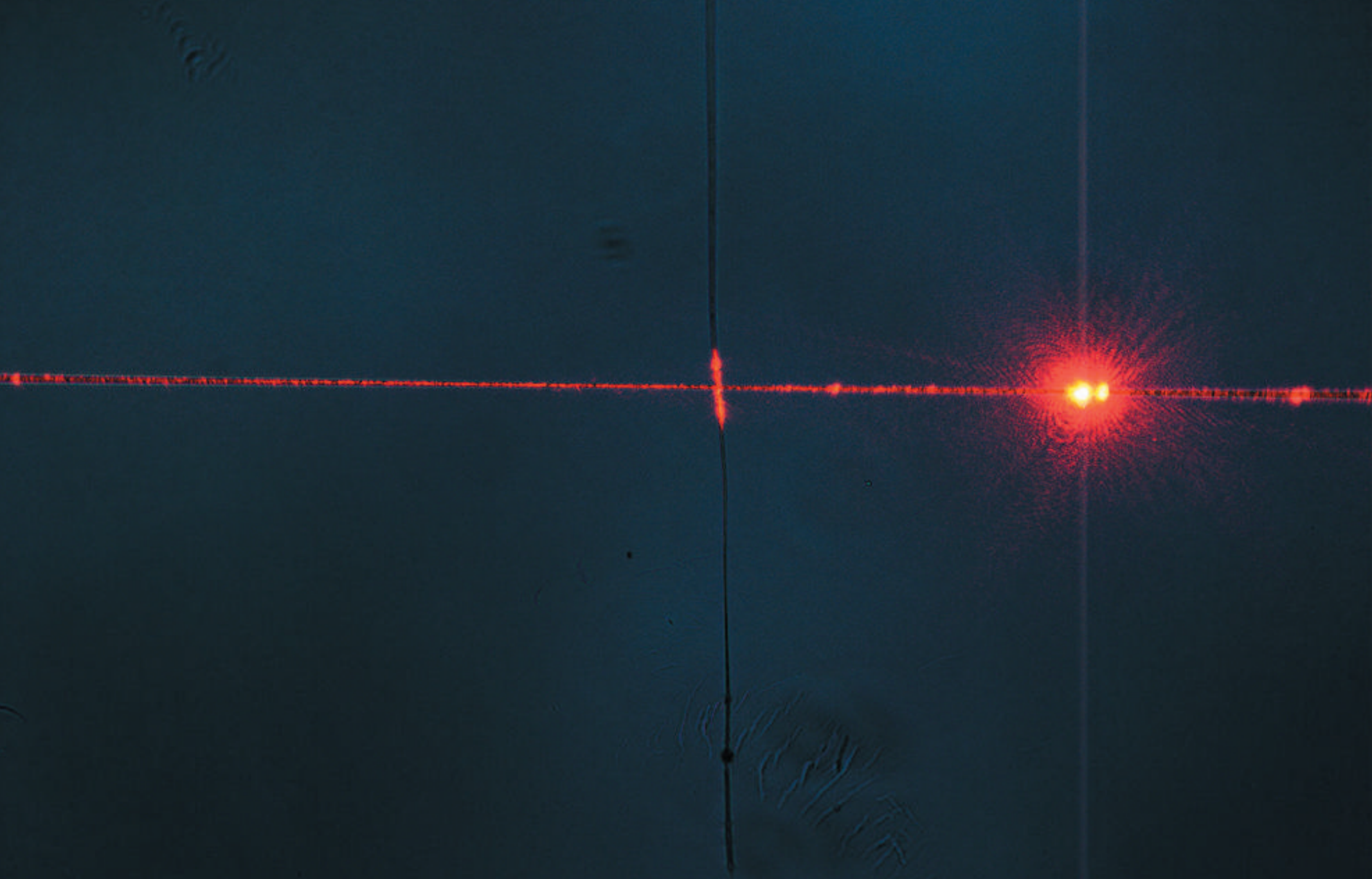

Optical properties

loss measurement

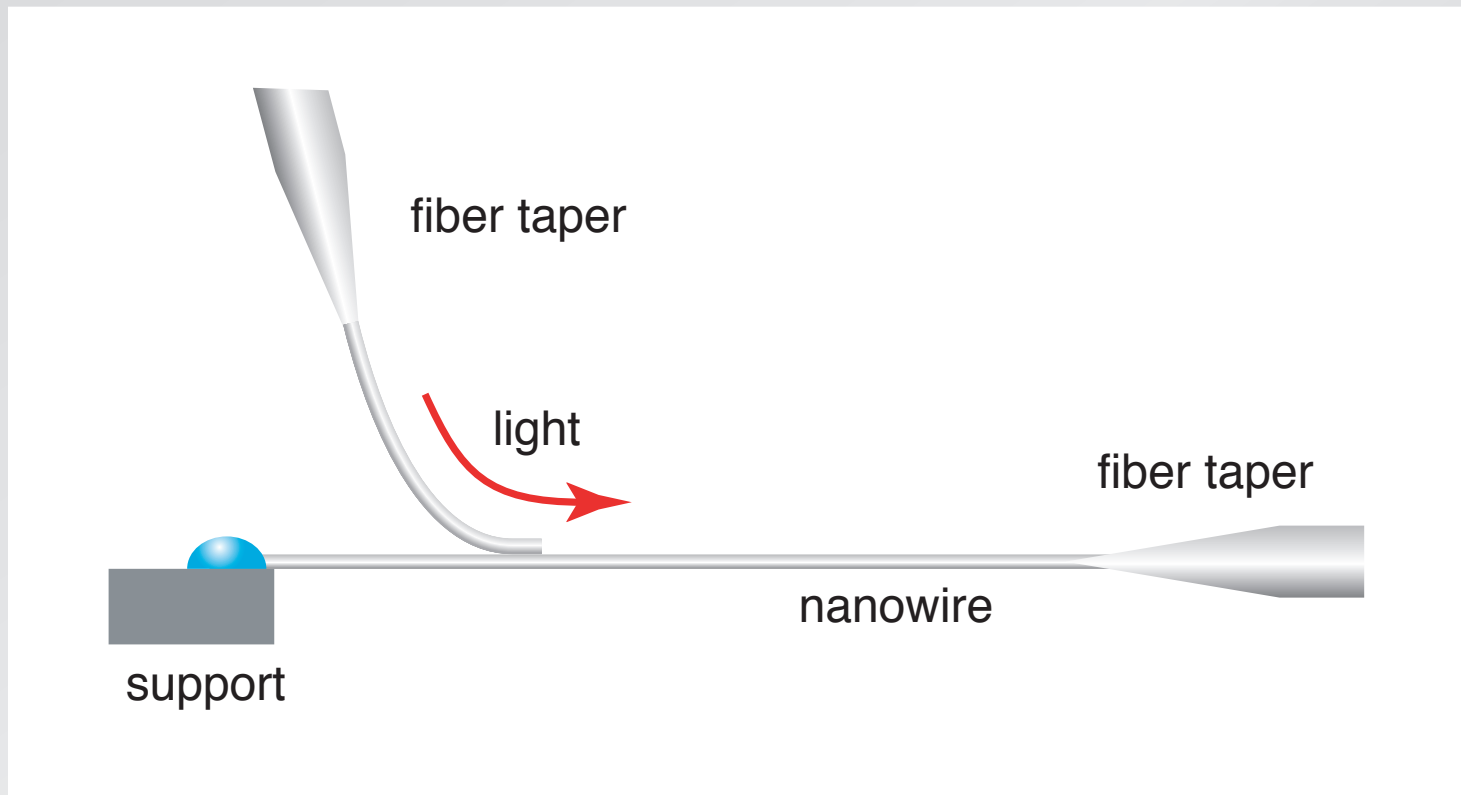

Optical properties

loss measurement

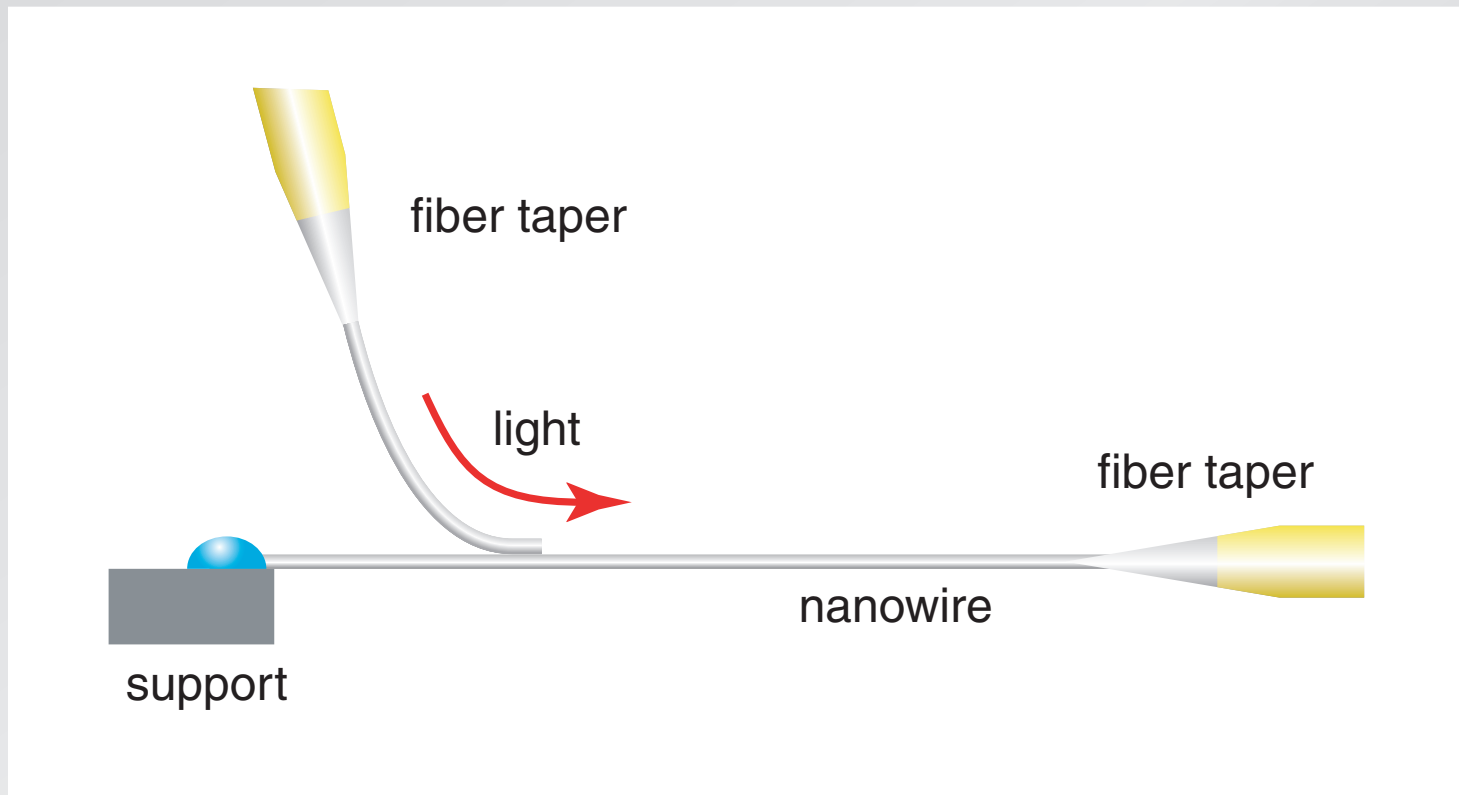

Optical properties

loss measurement

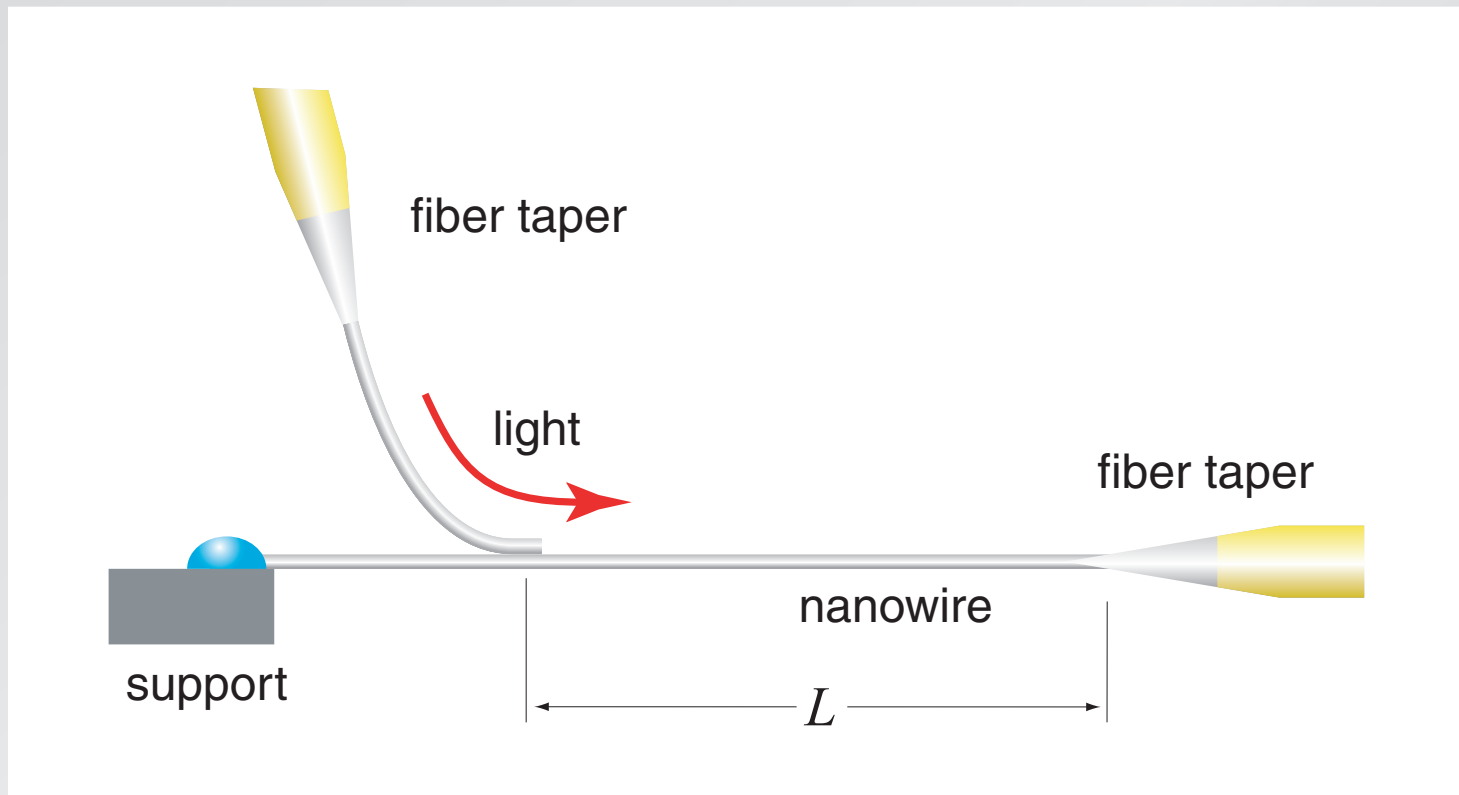

Optical properties

loss measurement

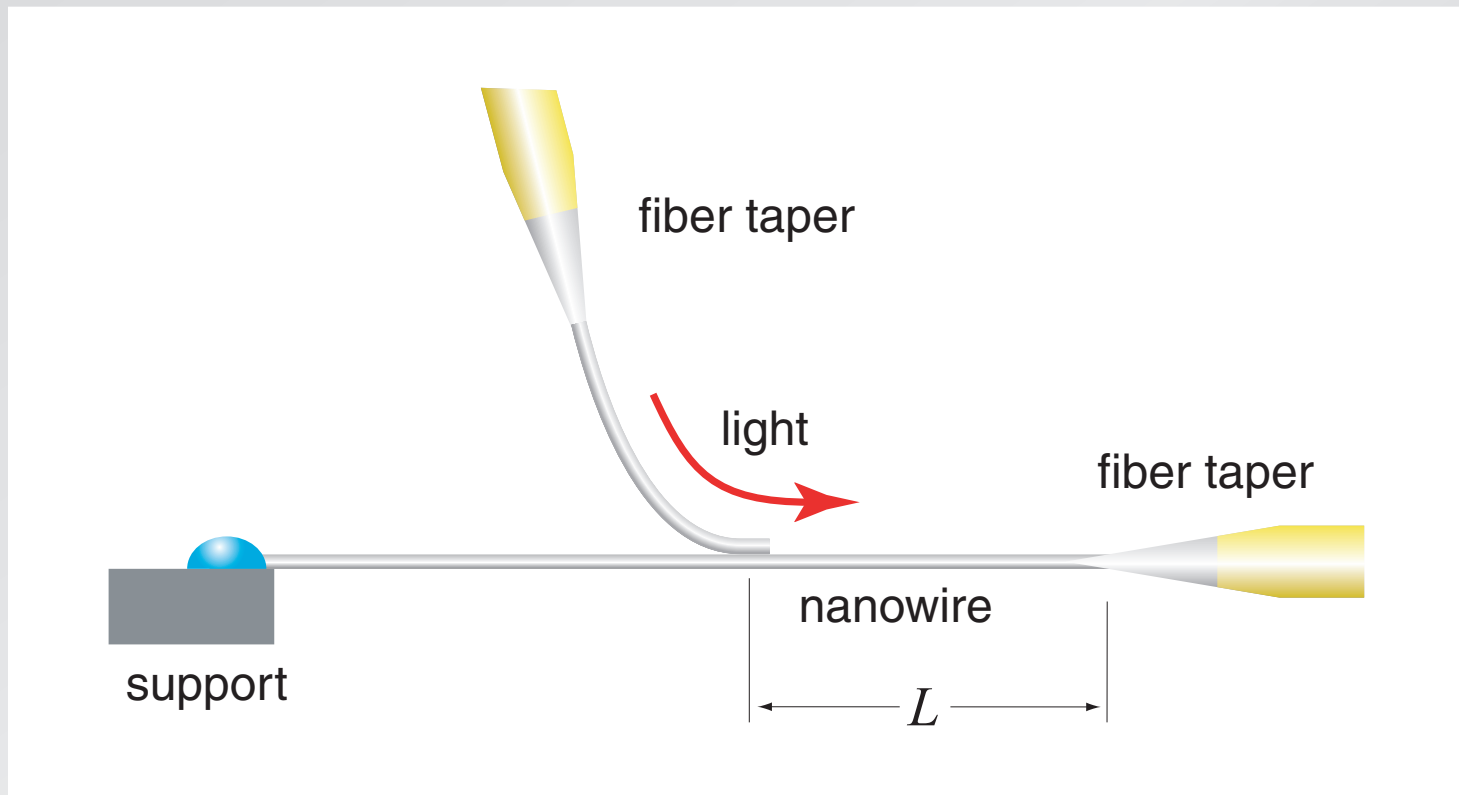

Optical properties

loss measurement

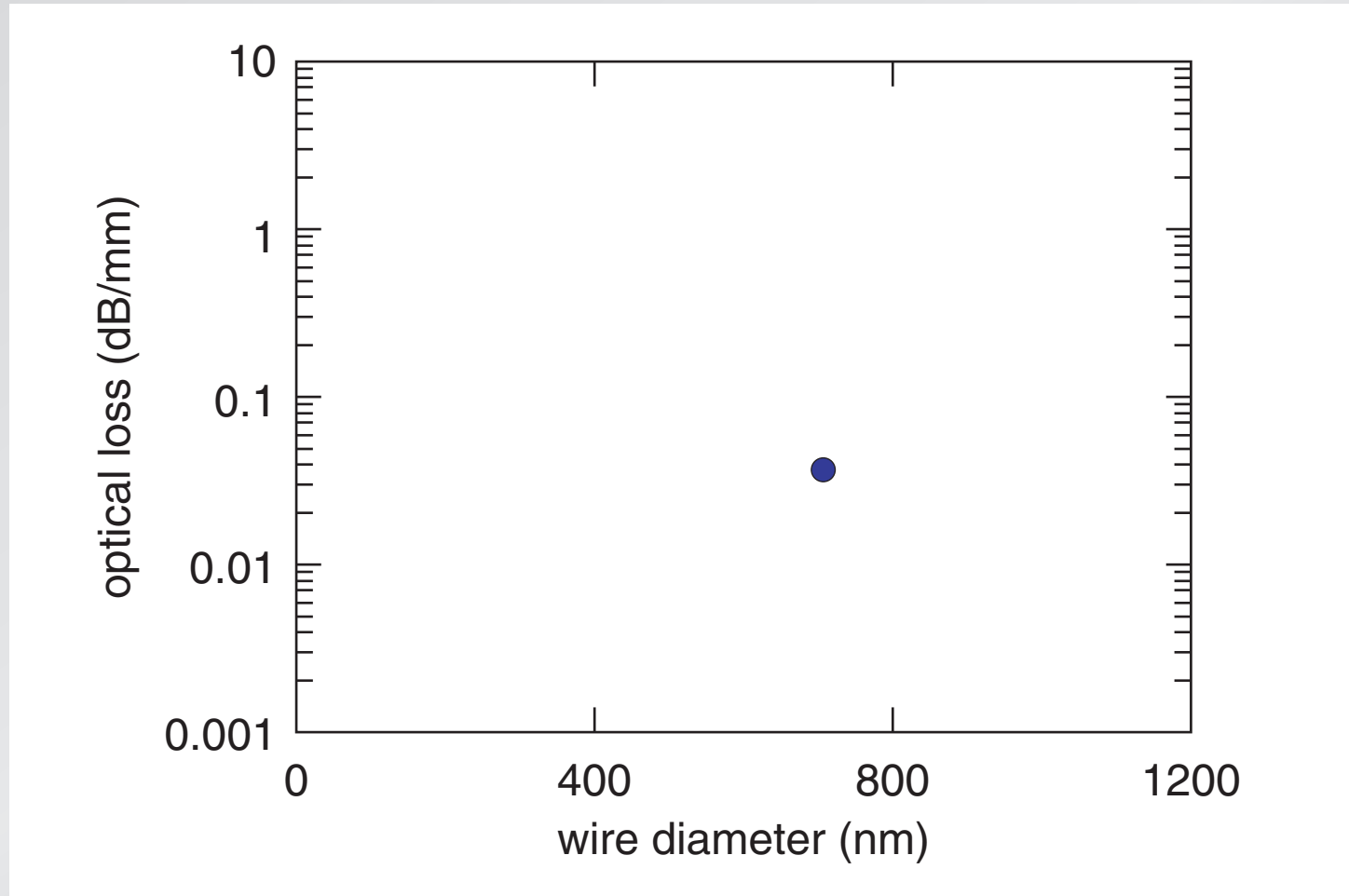

Nature, 426, 816 (2003)

Optical properties

loss measurement

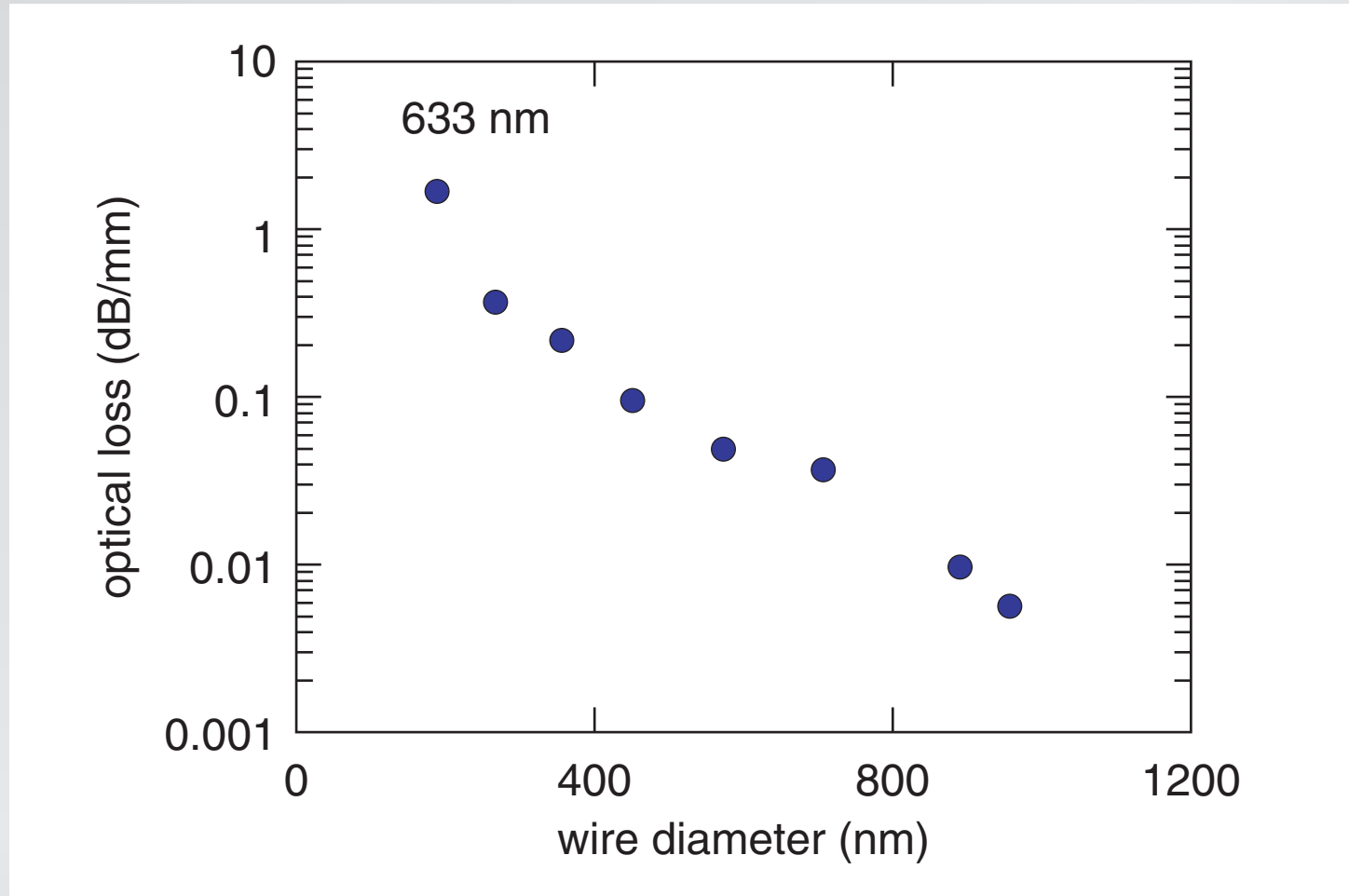

Optical properties

loss measurement

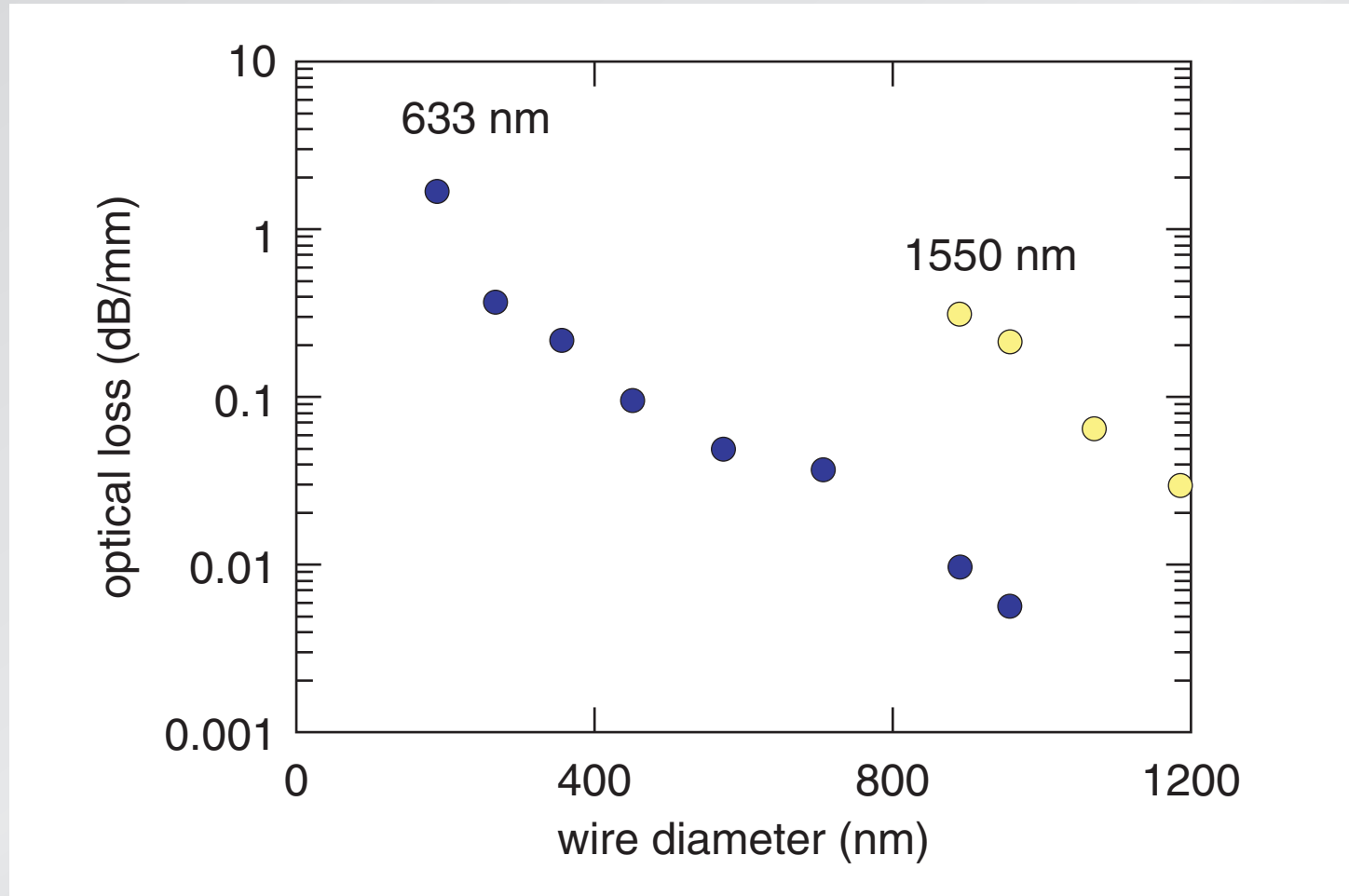

Optical properties

loss a single-mode diameter < 0.1 dB/mm

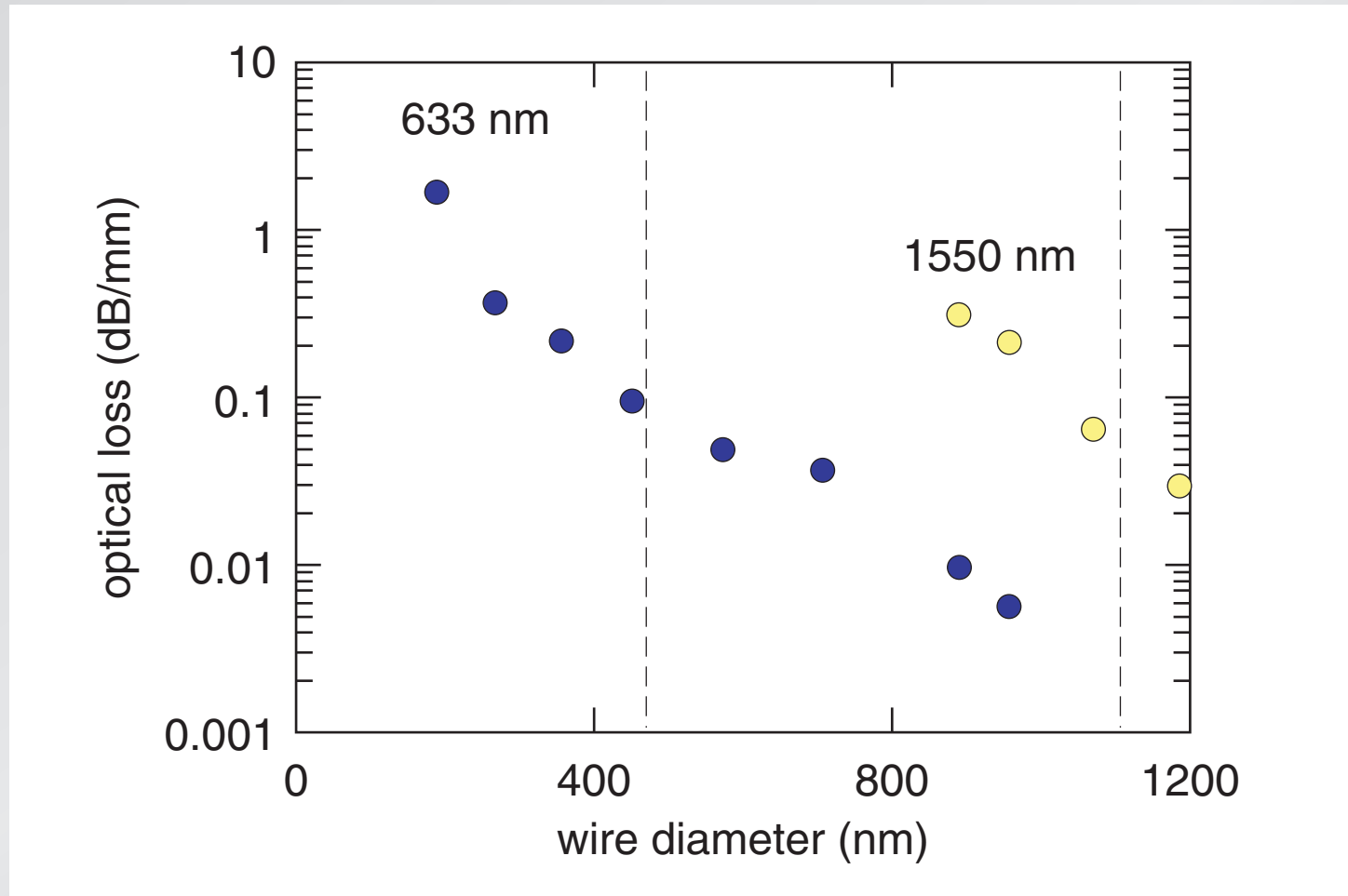

Nature, 426, 816 (2003)

Optical properties

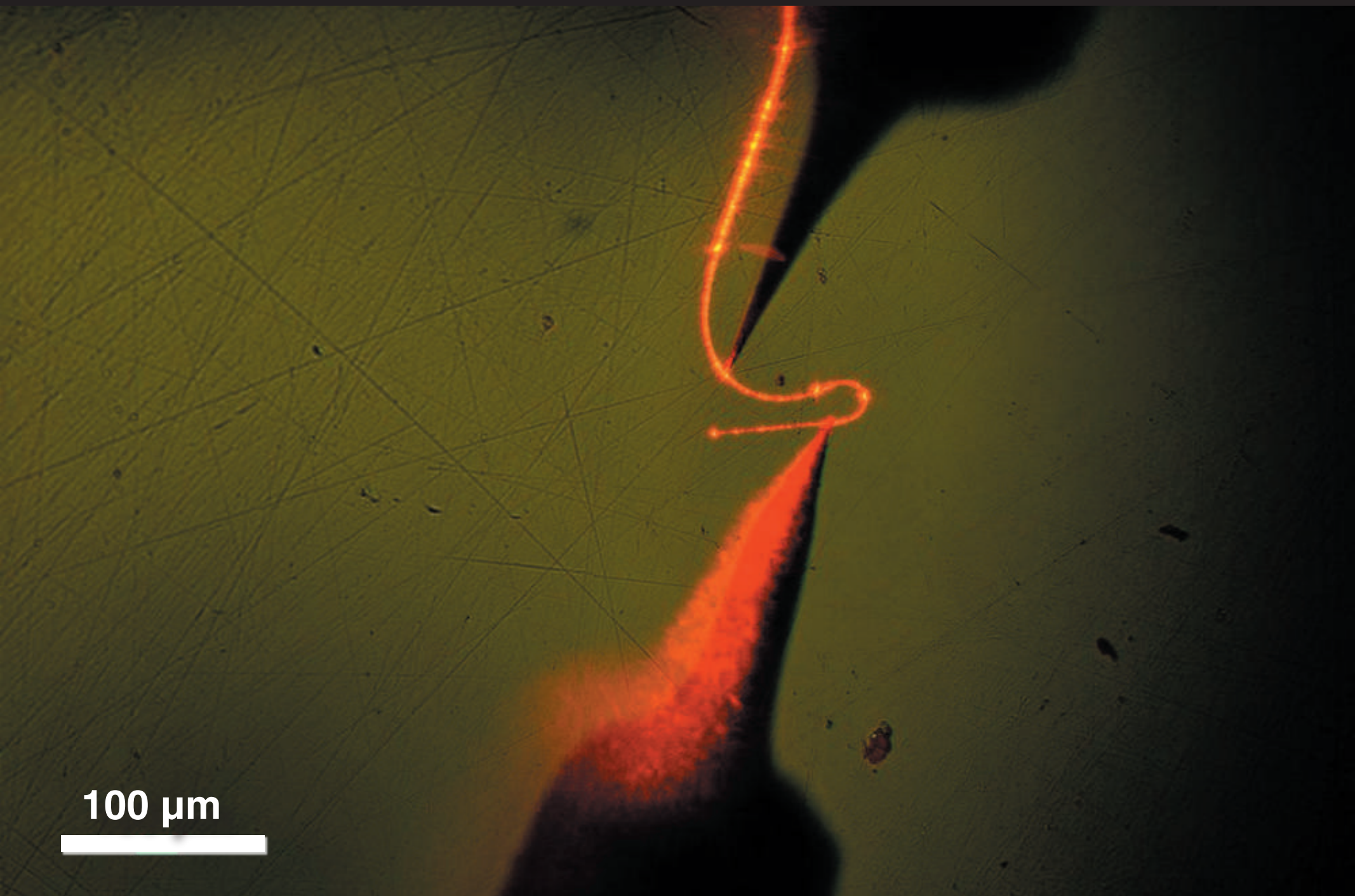

100 μm

Optical properties

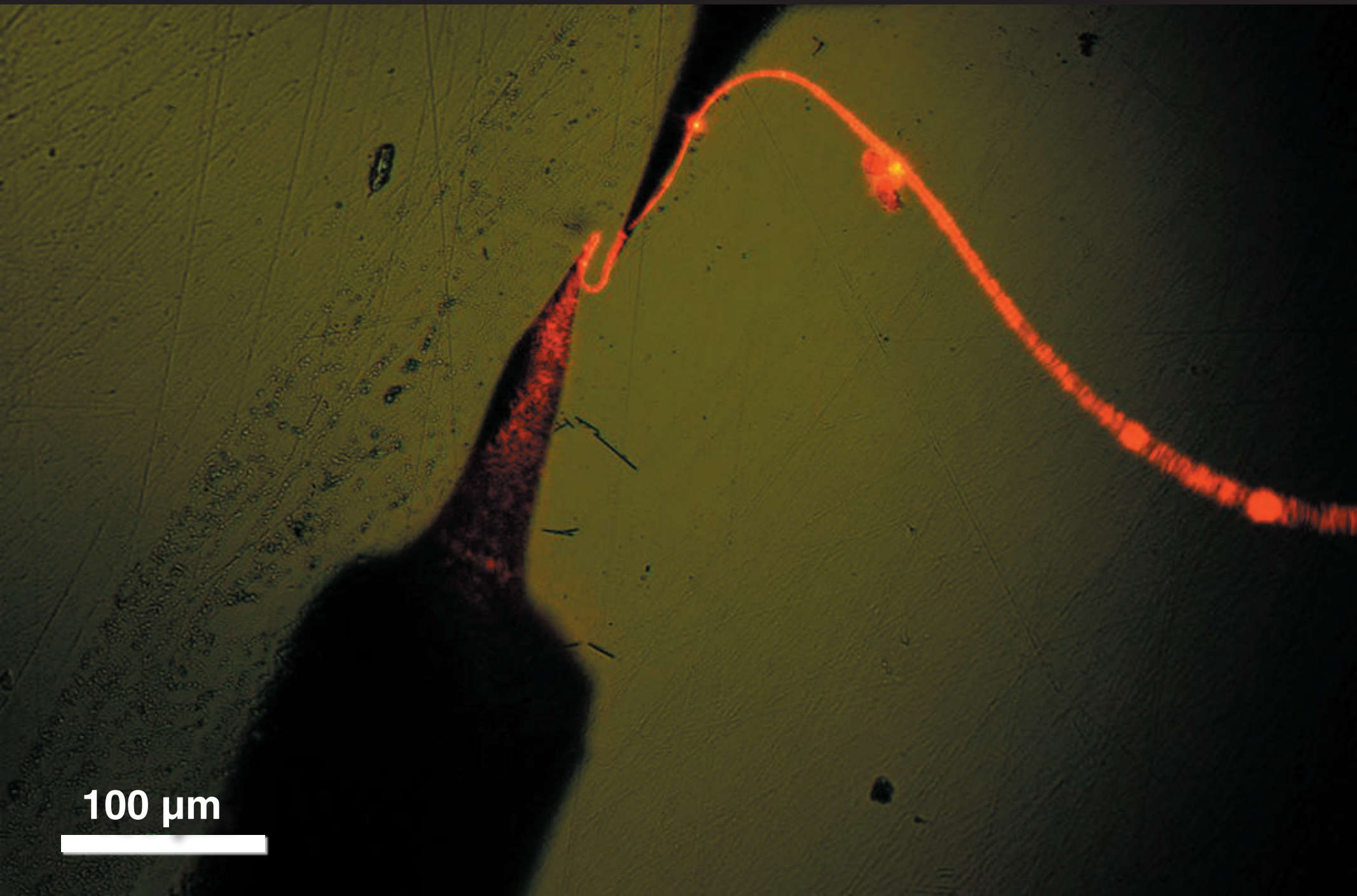

100 μm

Optical properties

minimum bending
radius: $5.6 \mu\text{m}$

100 μm



Optical properties

virtually no loss through 5 μm corner!

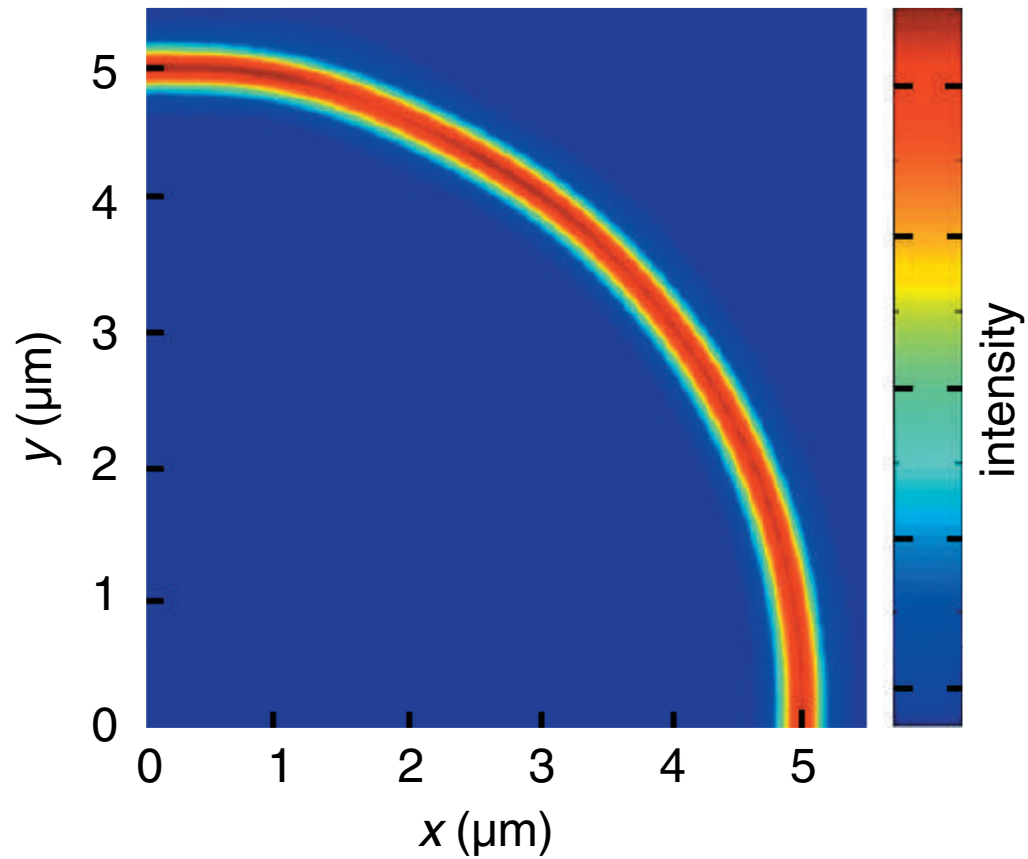

Optical properties

microphotonic components



Optical properties

microphotonic components

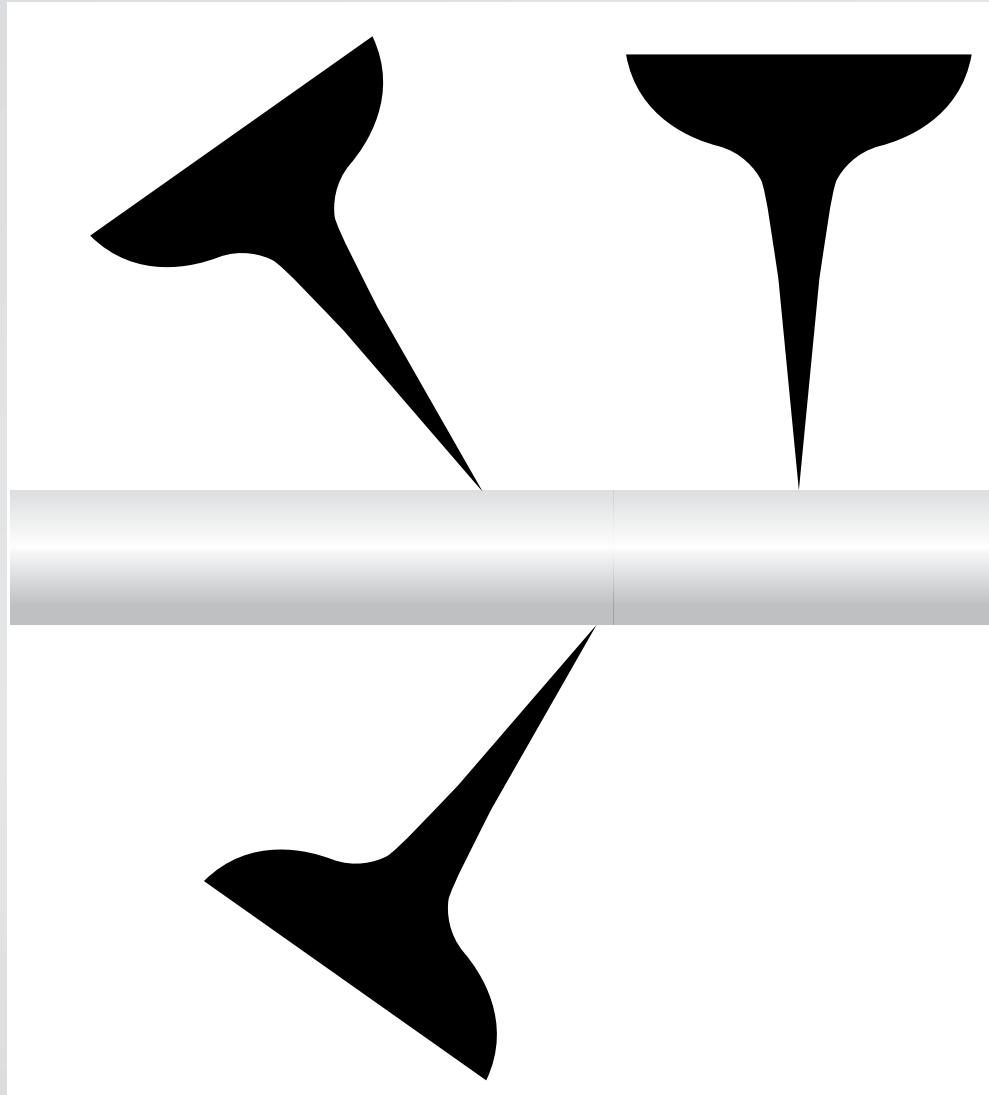

Optical properties

microphotonic components

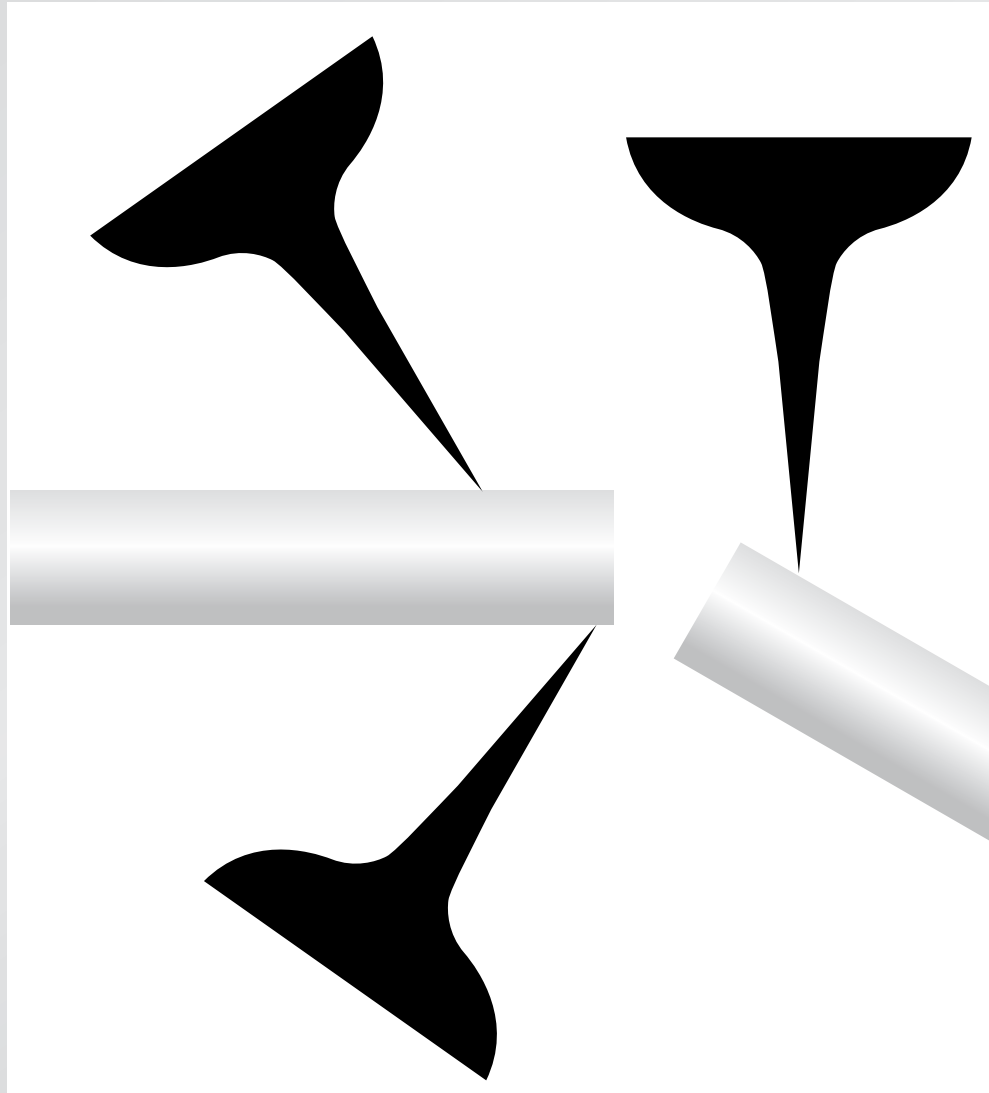

Optical properties

1 μm



Optical properties

500 nm

A grayscale micrograph showing three vertical nanowires of increasing diameter from left to right. The nanowires are positioned in the lower half of the frame. A white horizontal scale bar is located in the bottom-left corner, with the text '500 nm' positioned above it.

Optical properties

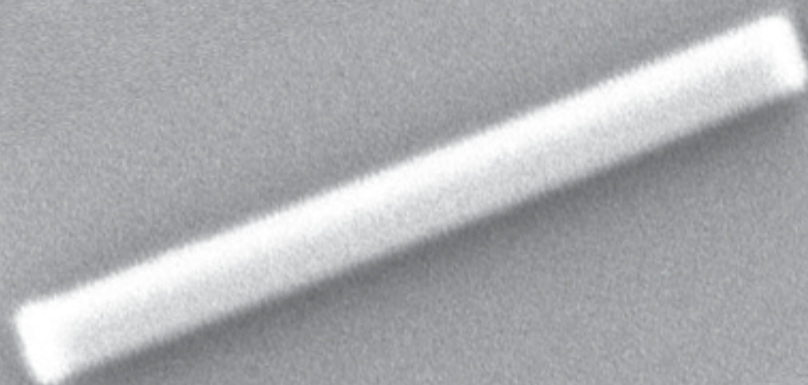

500 nm



Optical properties



Optical properties

Aerogel

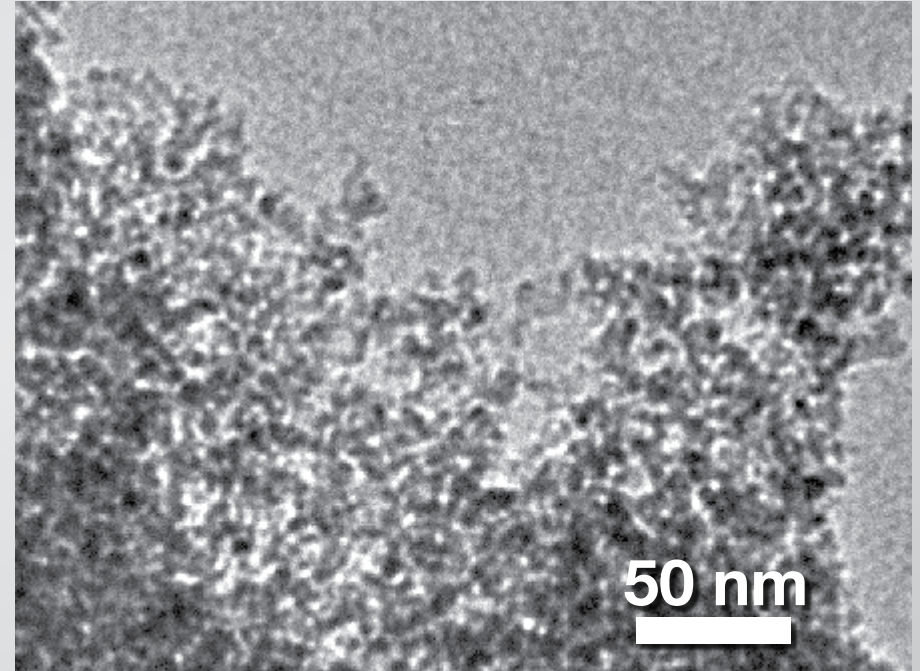
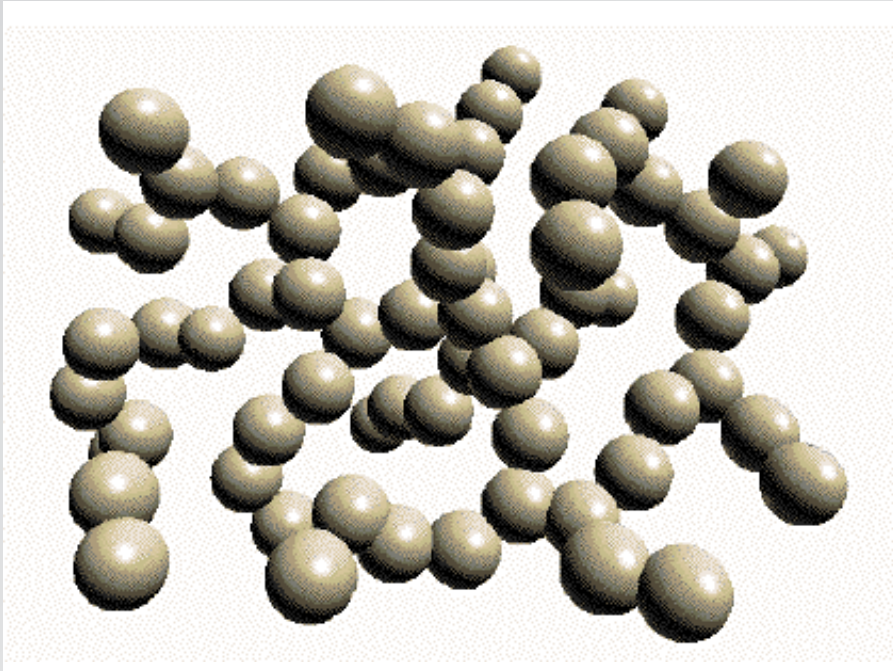

density: 1.9 kg/m^3

index of refraction: 1.03–1.08

Optical properties



Optical properties

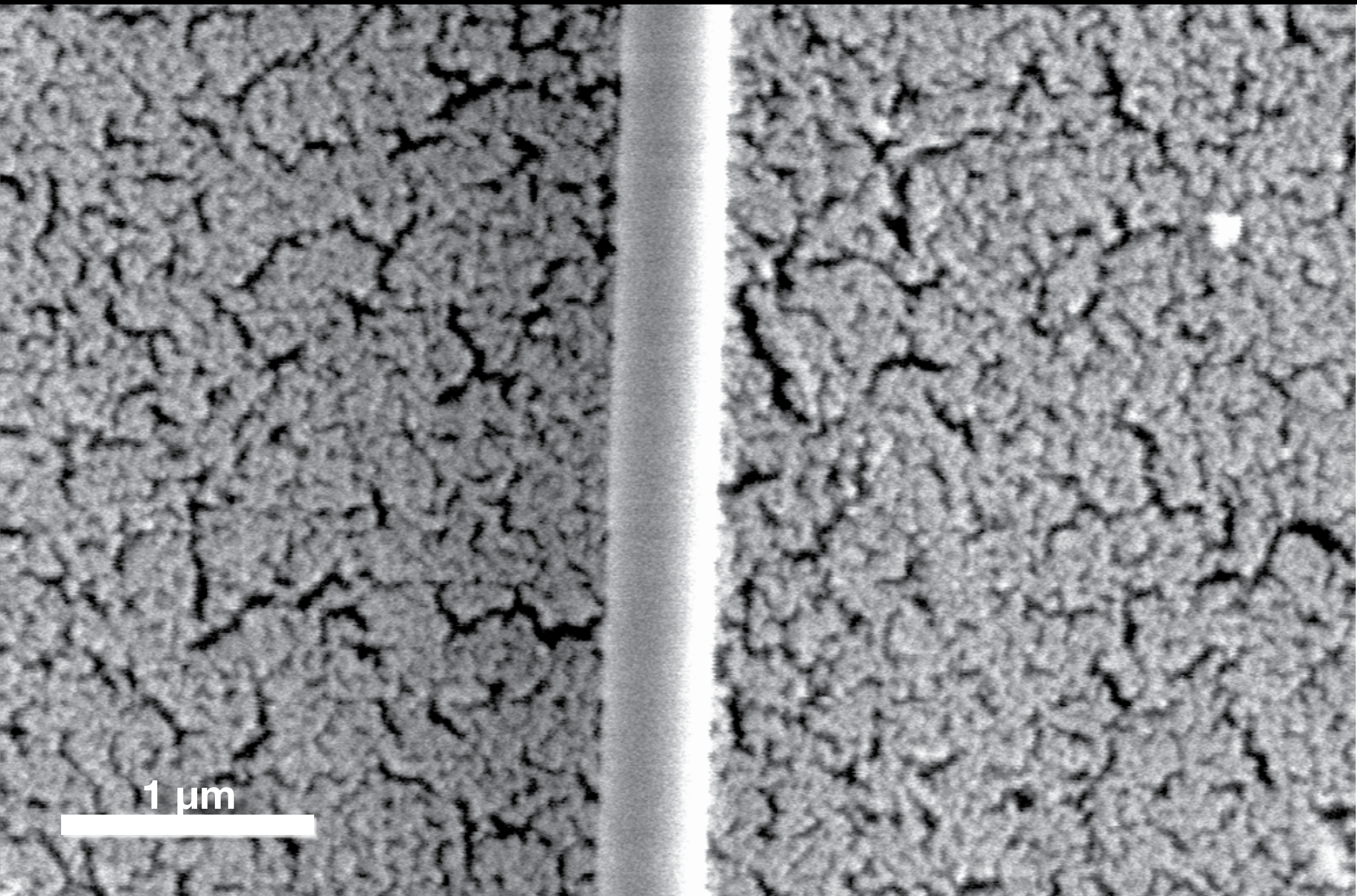

1 μm



Optical properties

loss measurement @ 633 nm

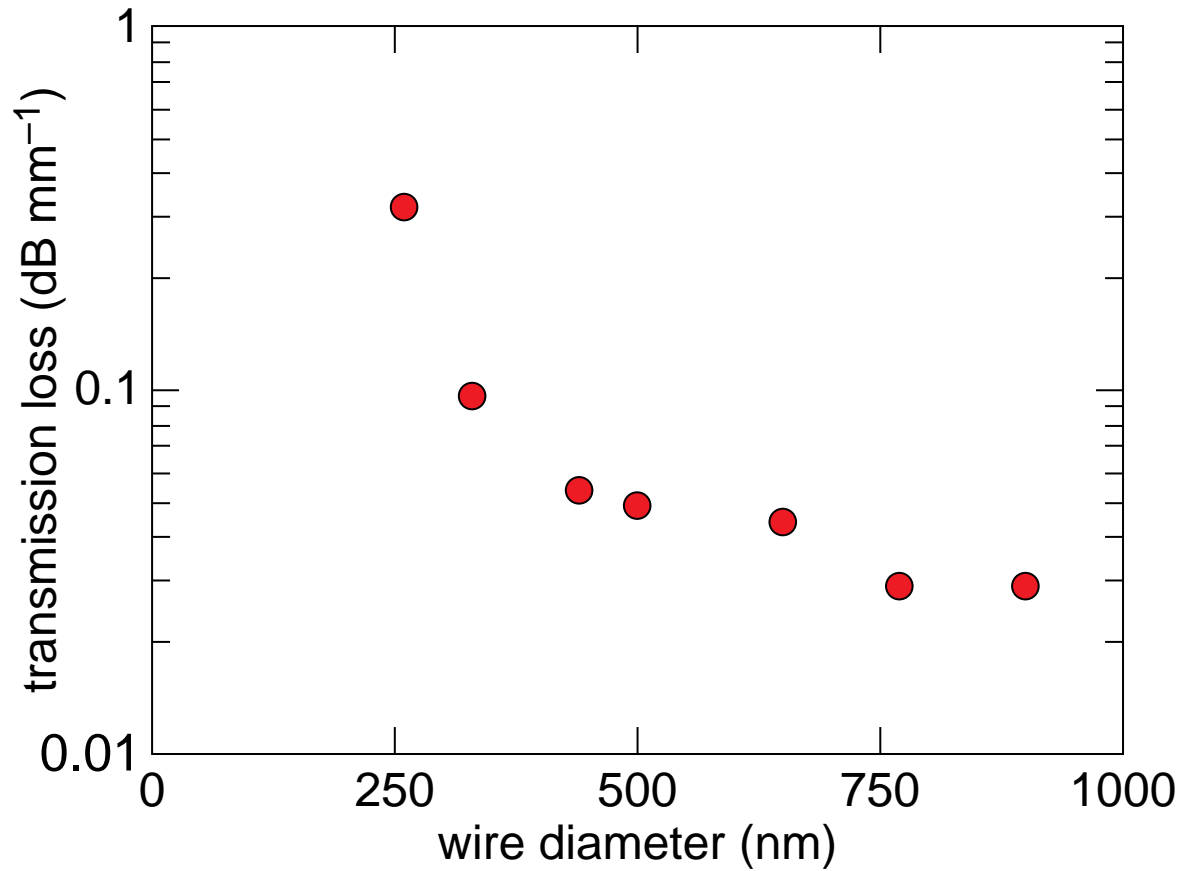

Nano Lett., 5, 259–262 (2005)

Optical properties

530 nm

50 μm

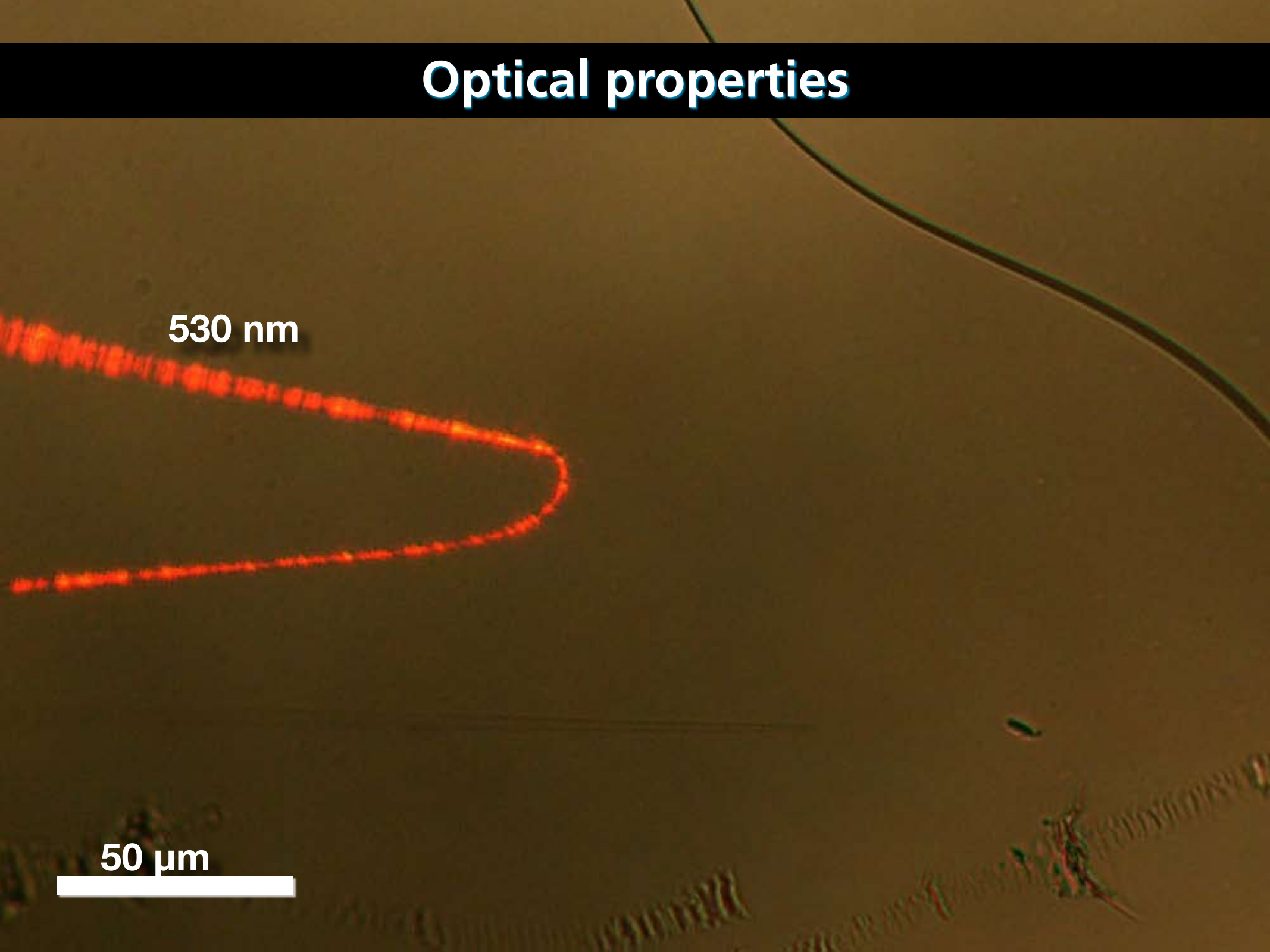

Optical properties

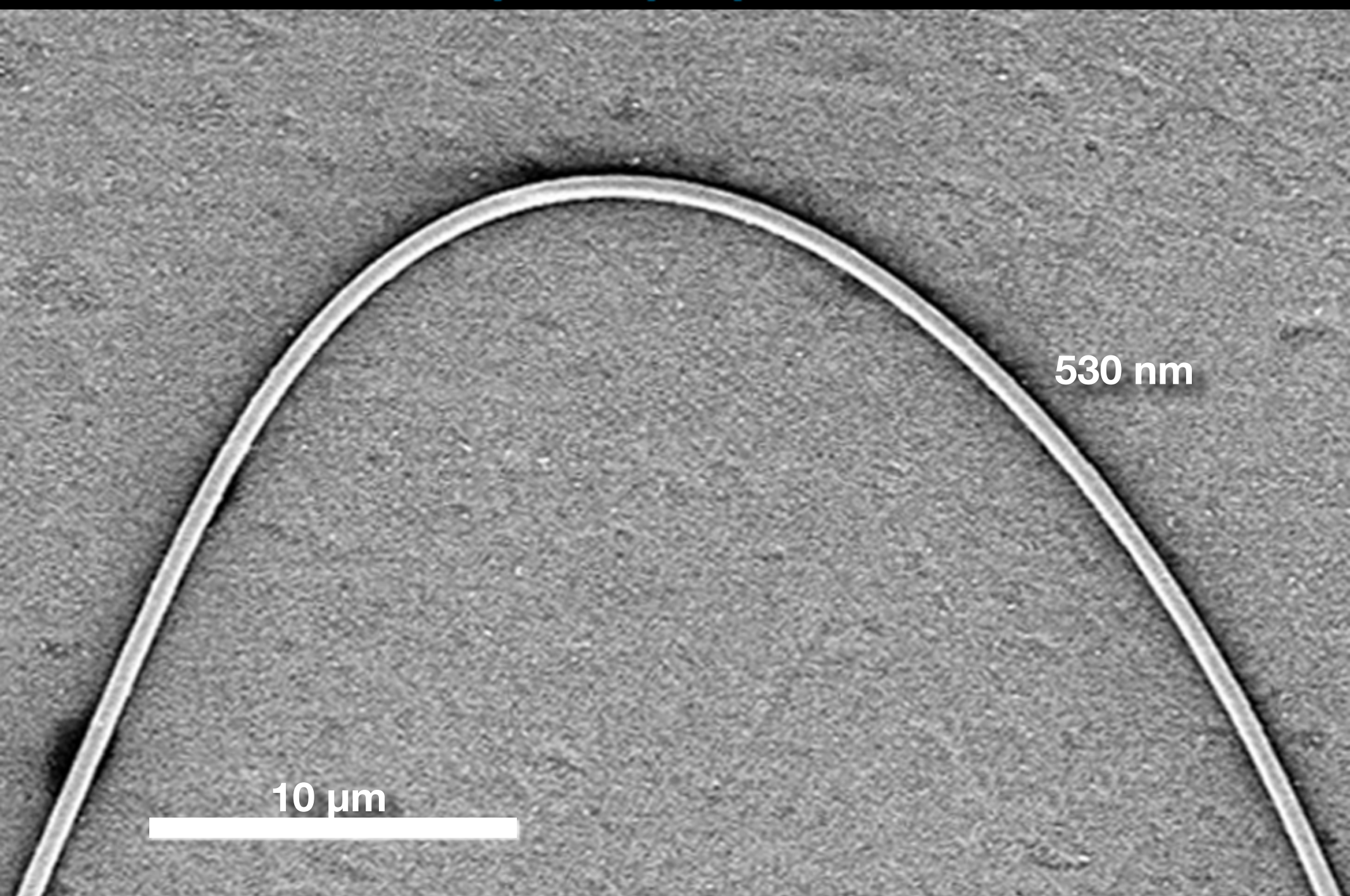

530 nm

10 μm

Optical properties

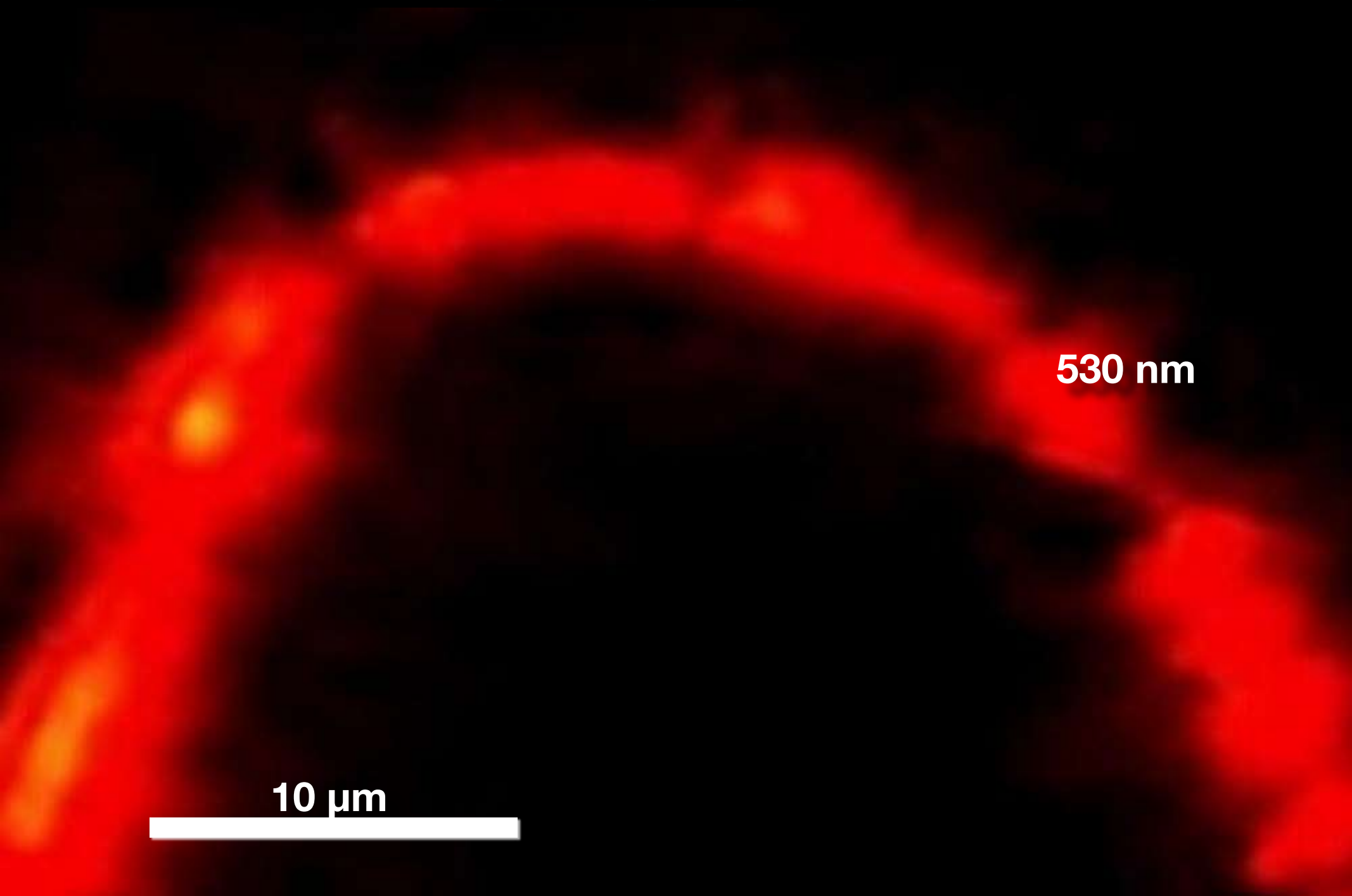

Optical properties

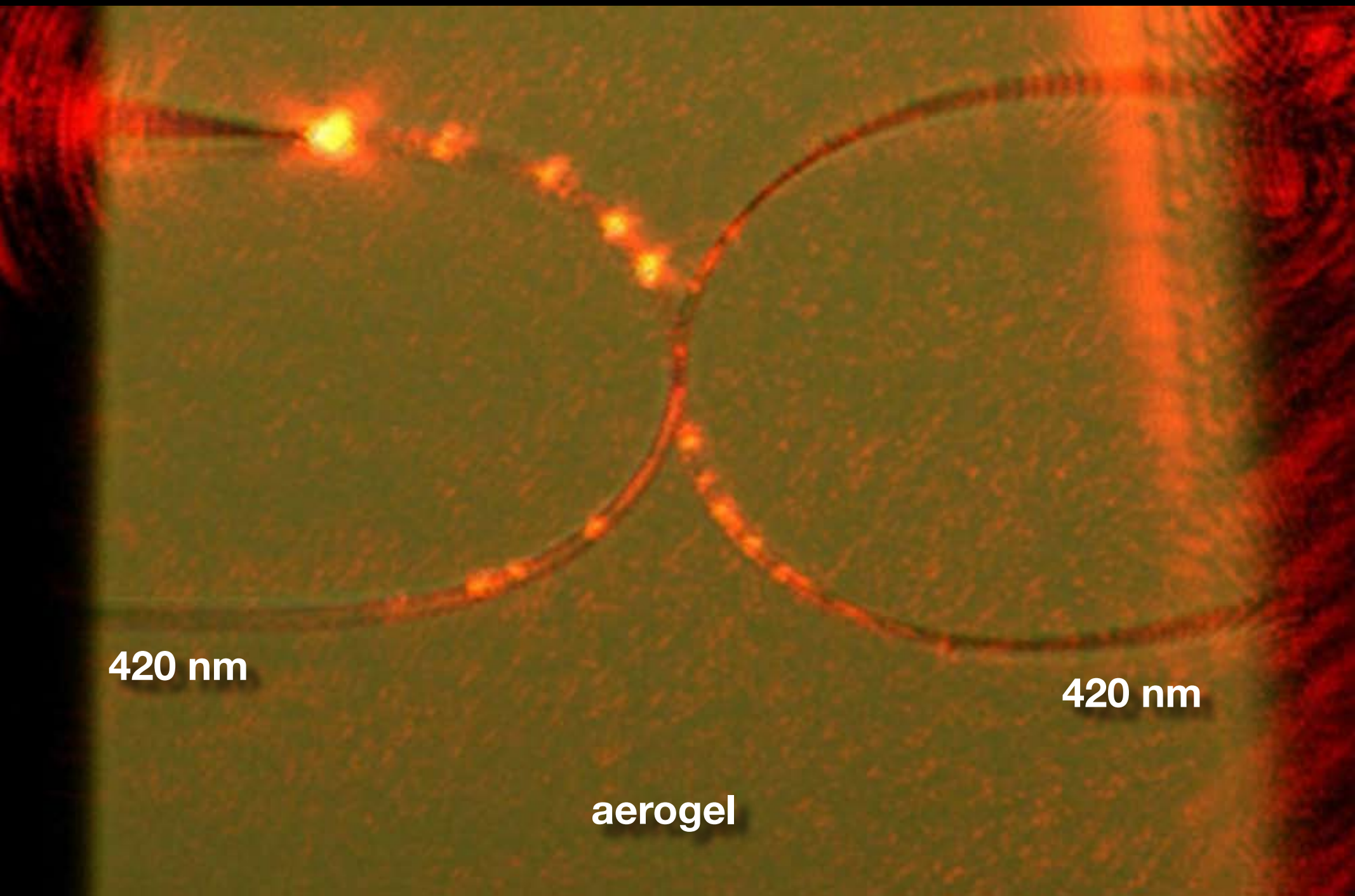

420 nm

420 nm

aerogel

Optical properties

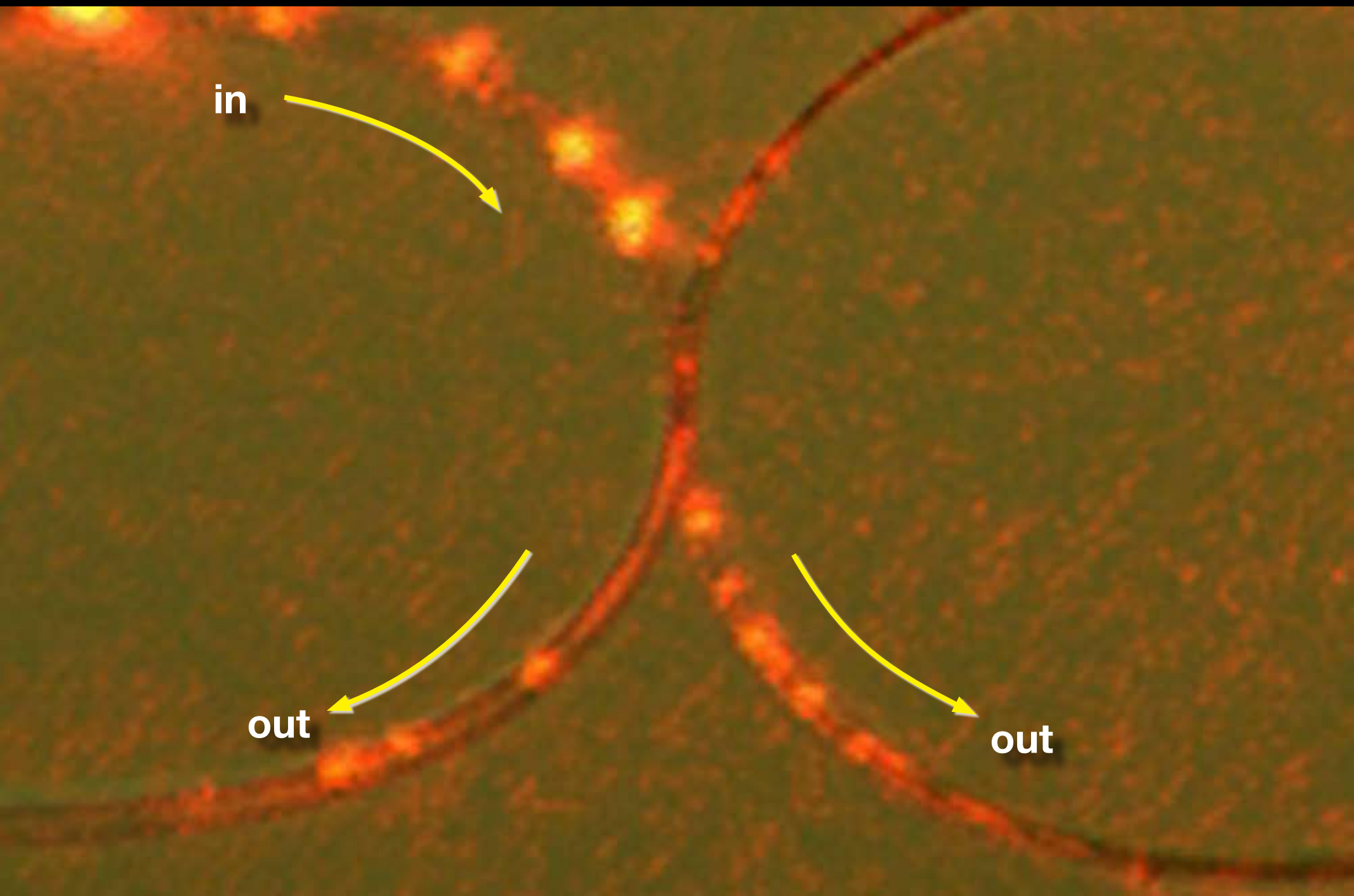

Optical properties

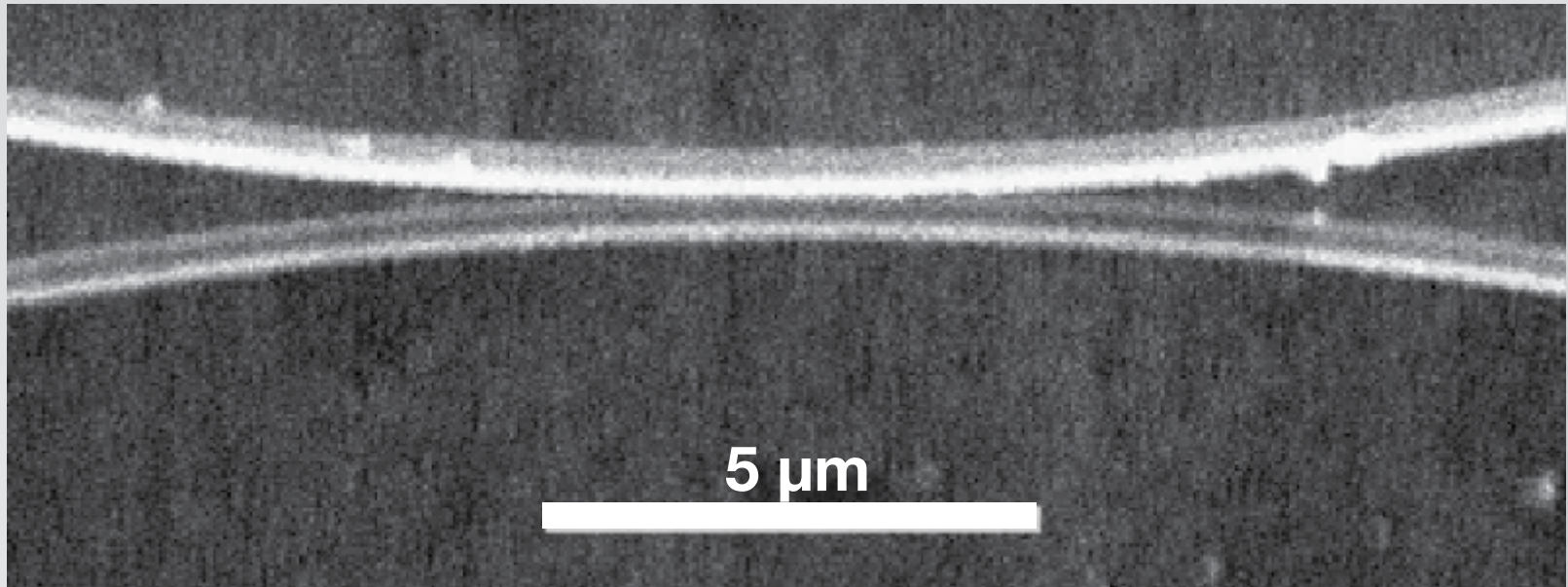

Nonlinear properties

nonlinear dispersion: $n = n_0 + n_2 I$

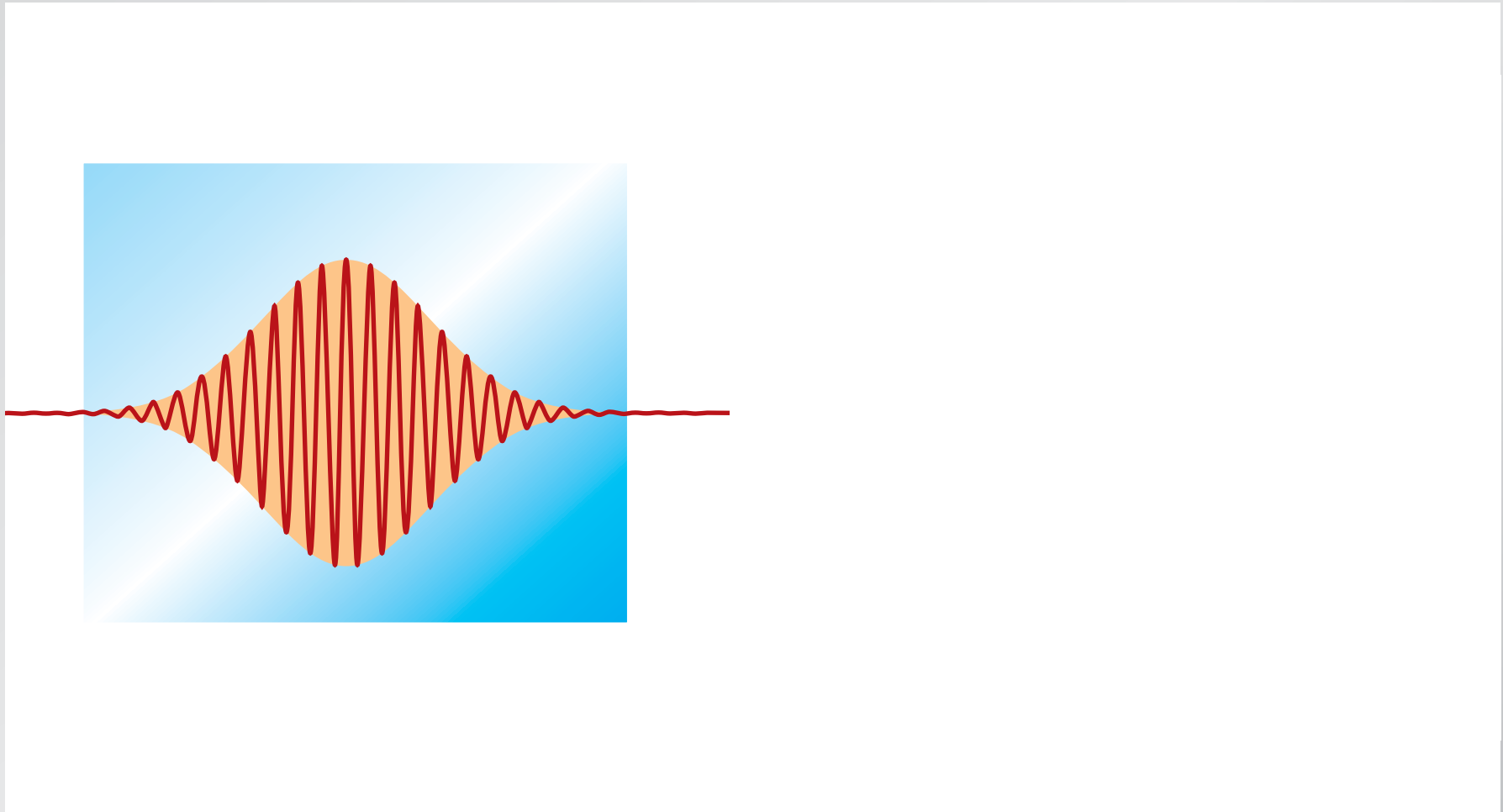

Nonlinear properties

nonlinear dispersion: $n = n_0 + n_2 I$

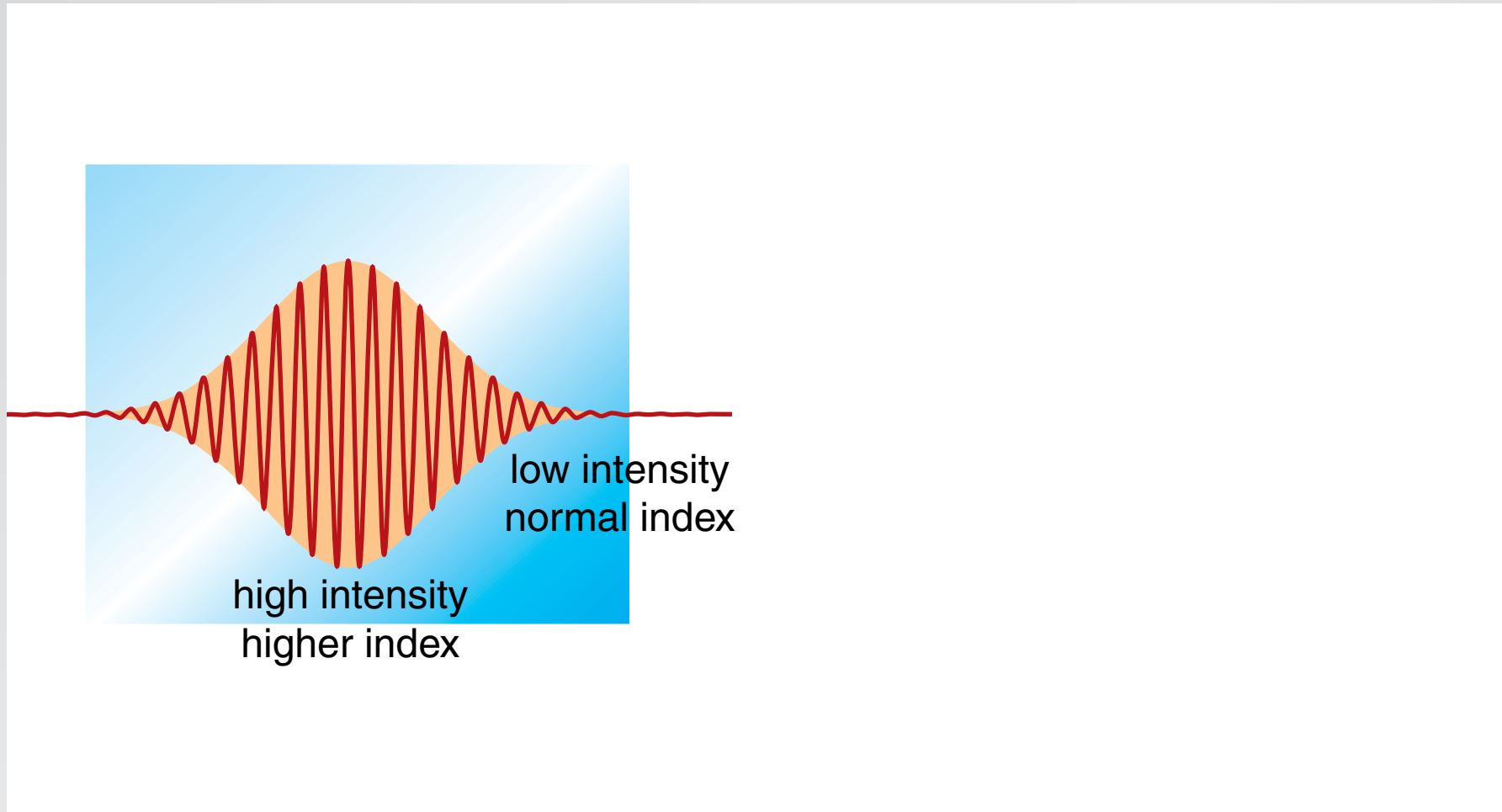

Nonlinear properties

nonlinear dispersion: $n = n_0 + n_2 I$

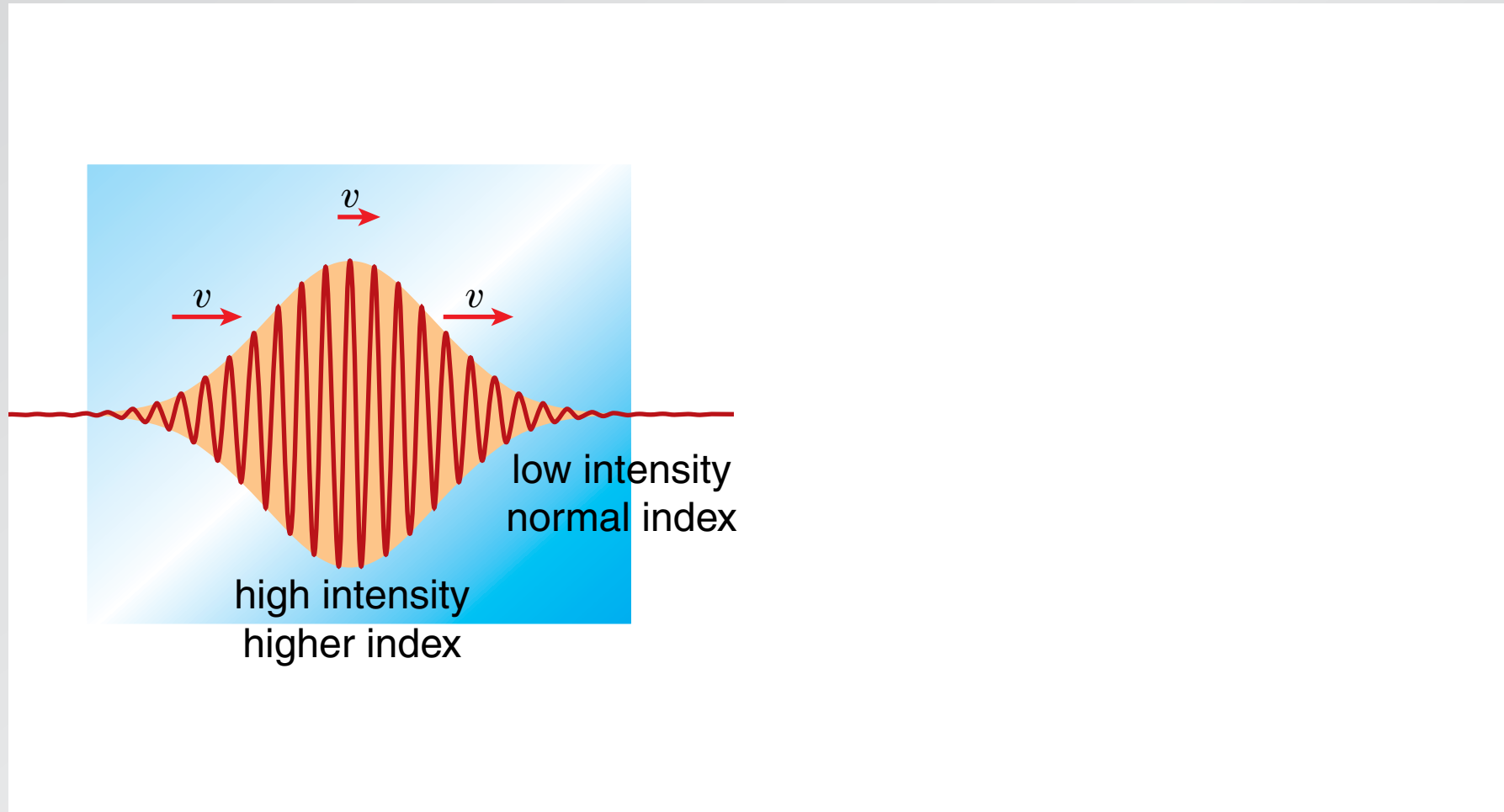

Nonlinear properties

nonlinear dispersion: $n = n_0 + n_2 I$

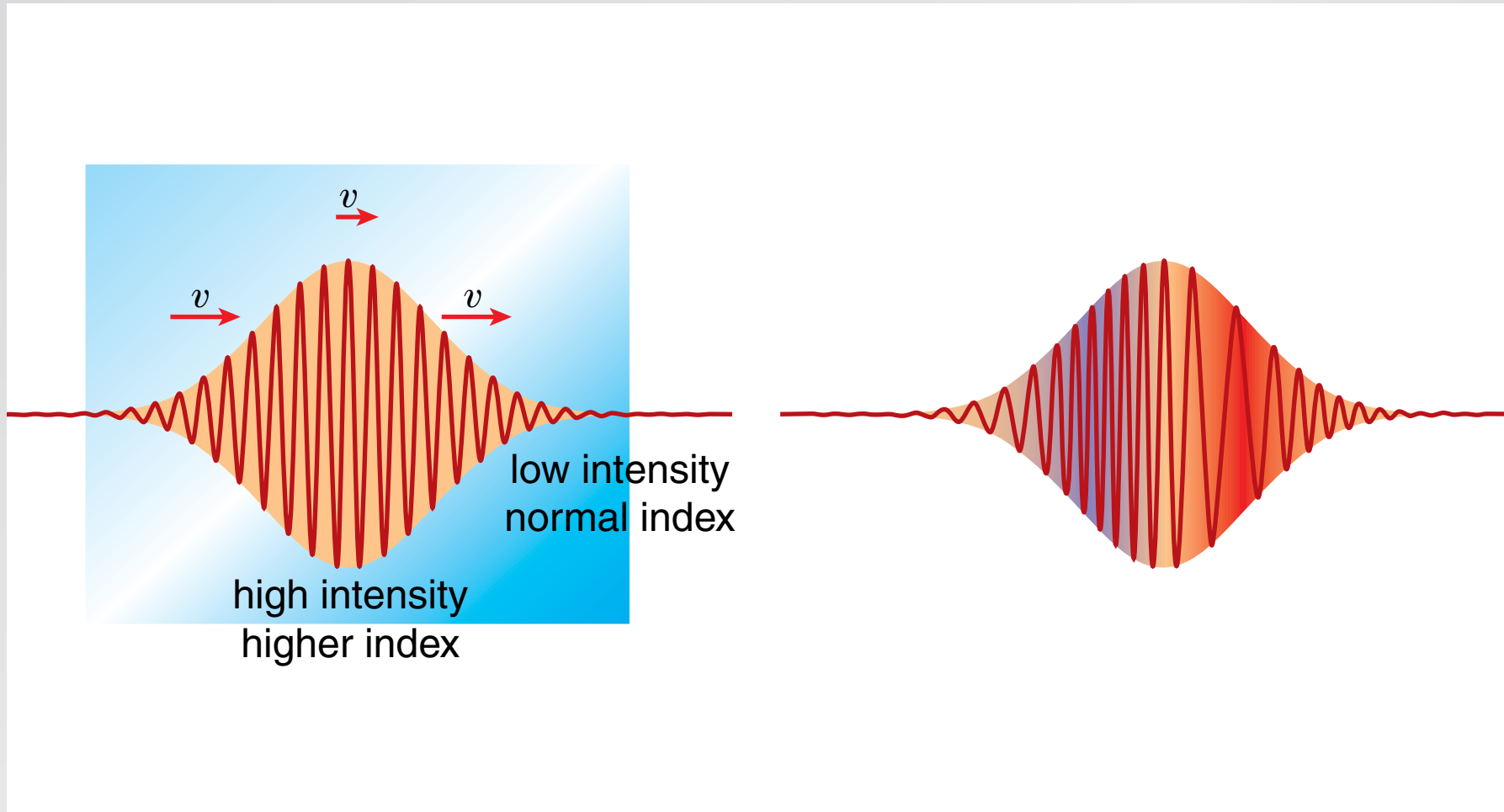

Nonlinear properties

nonlinear dispersion: $n = n_0 + n_2 I$

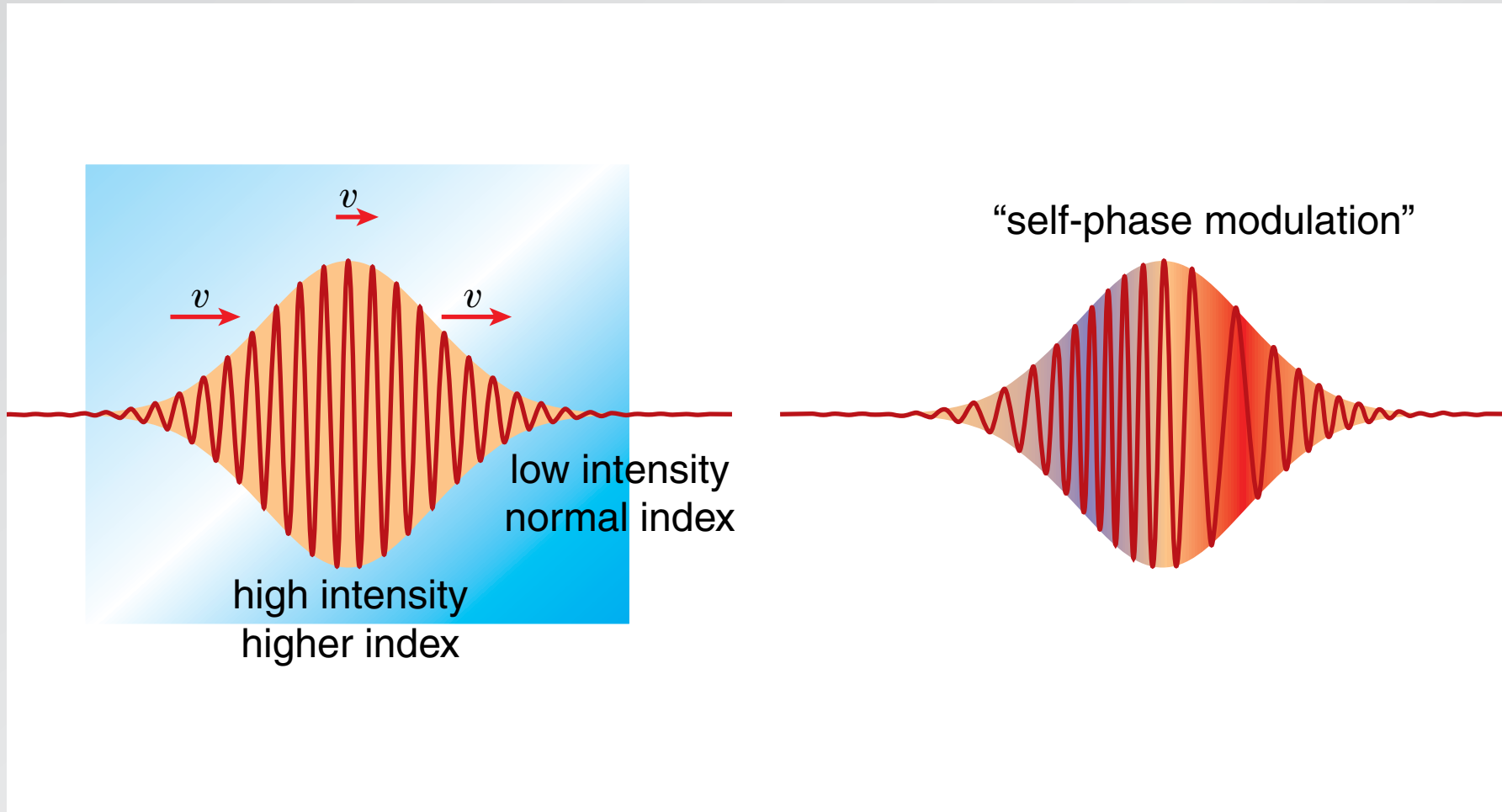

Nonlinear properties

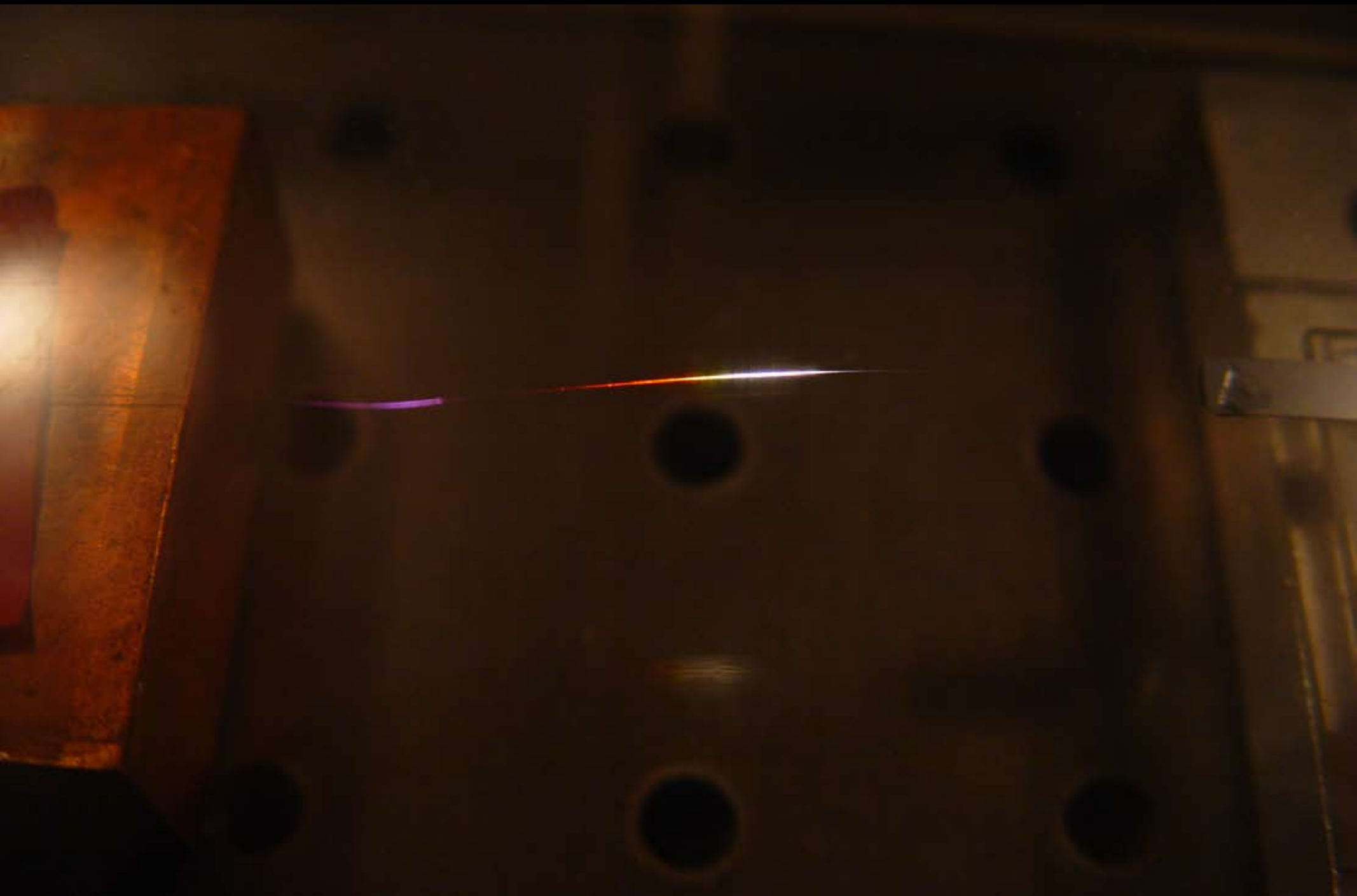

Nonlinear properties



Nonlinear properties

strong confinement \longrightarrow **high intensity**

Nonlinear properties

mode field diameter ($\lambda = 800$ nm)

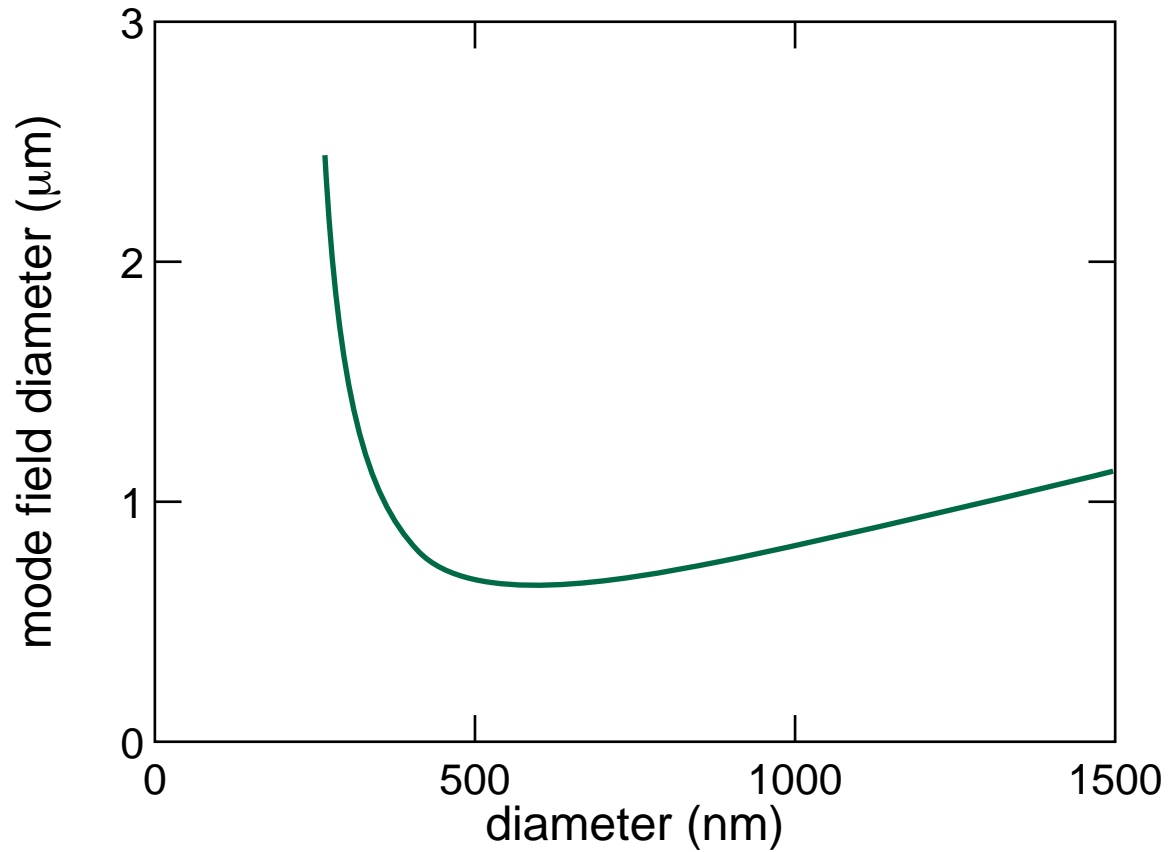

M.A. Foster, et al., *Optics Express*, 12, 2880 (2004)

Nonlinear properties

mode field diameter ($\lambda = 800$ nm)

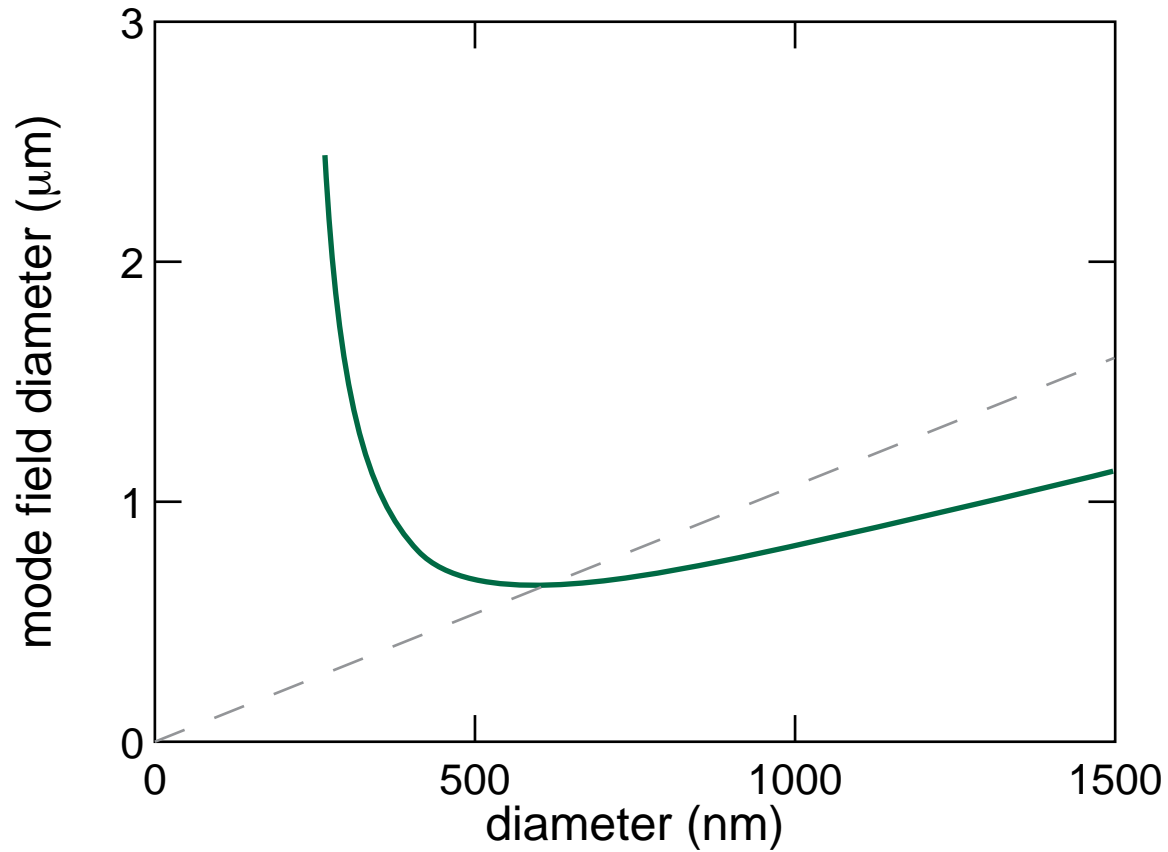

M.A. Foster, et al., *Optics Express*, 12, 2880 (2004)

Nonlinear properties

nonlinear parameter

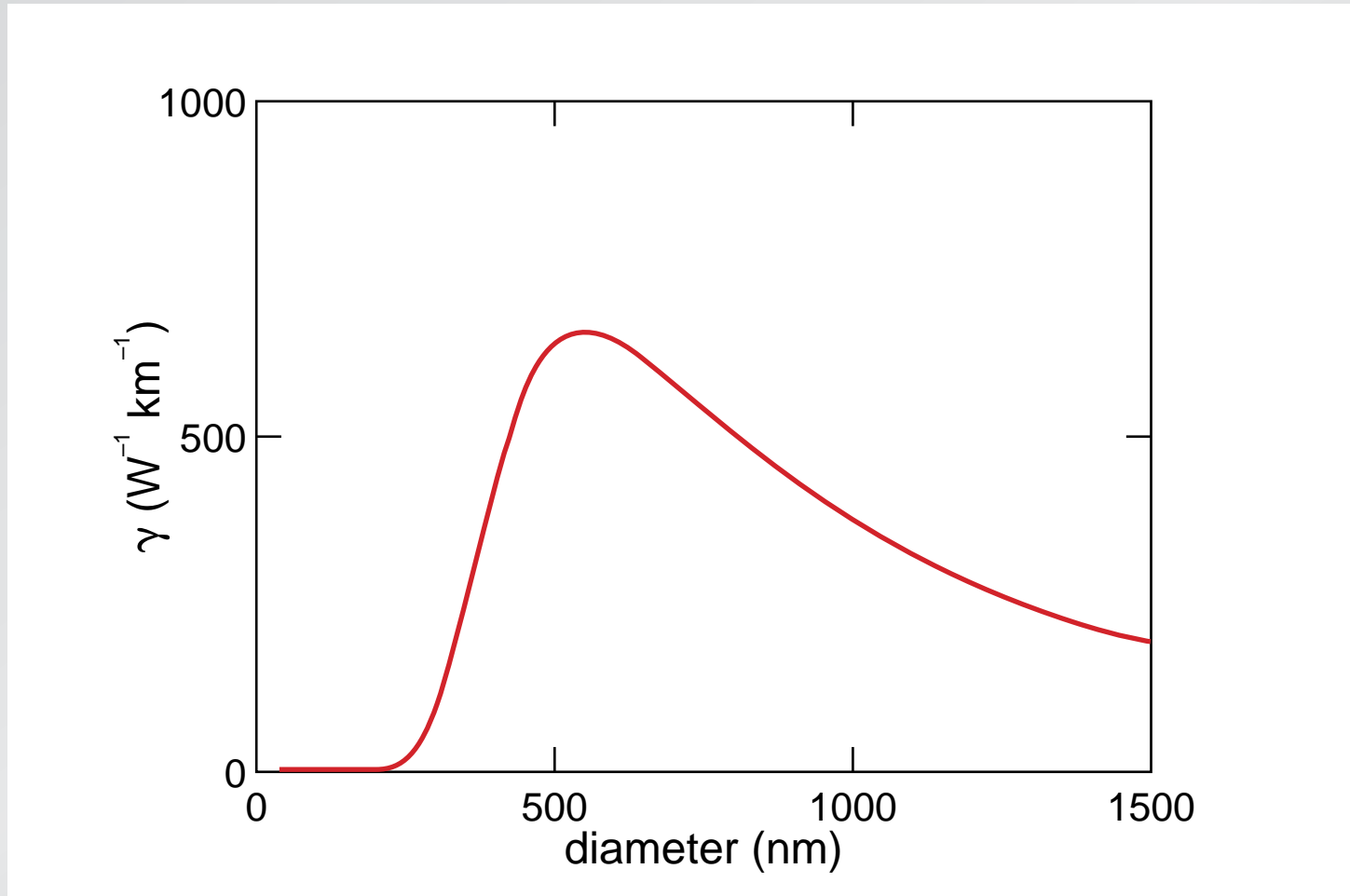

M.A. Foster, et al., *Optics Express*, 12, 2880 (2004)

Nonlinear properties

dispersion important!

Nonlinear properties

dispersion:

- modal dispersion
- material dispersion
- waveguide dispersion
- nonlinear dispersion

Nonlinear properties

waveguide dispersion

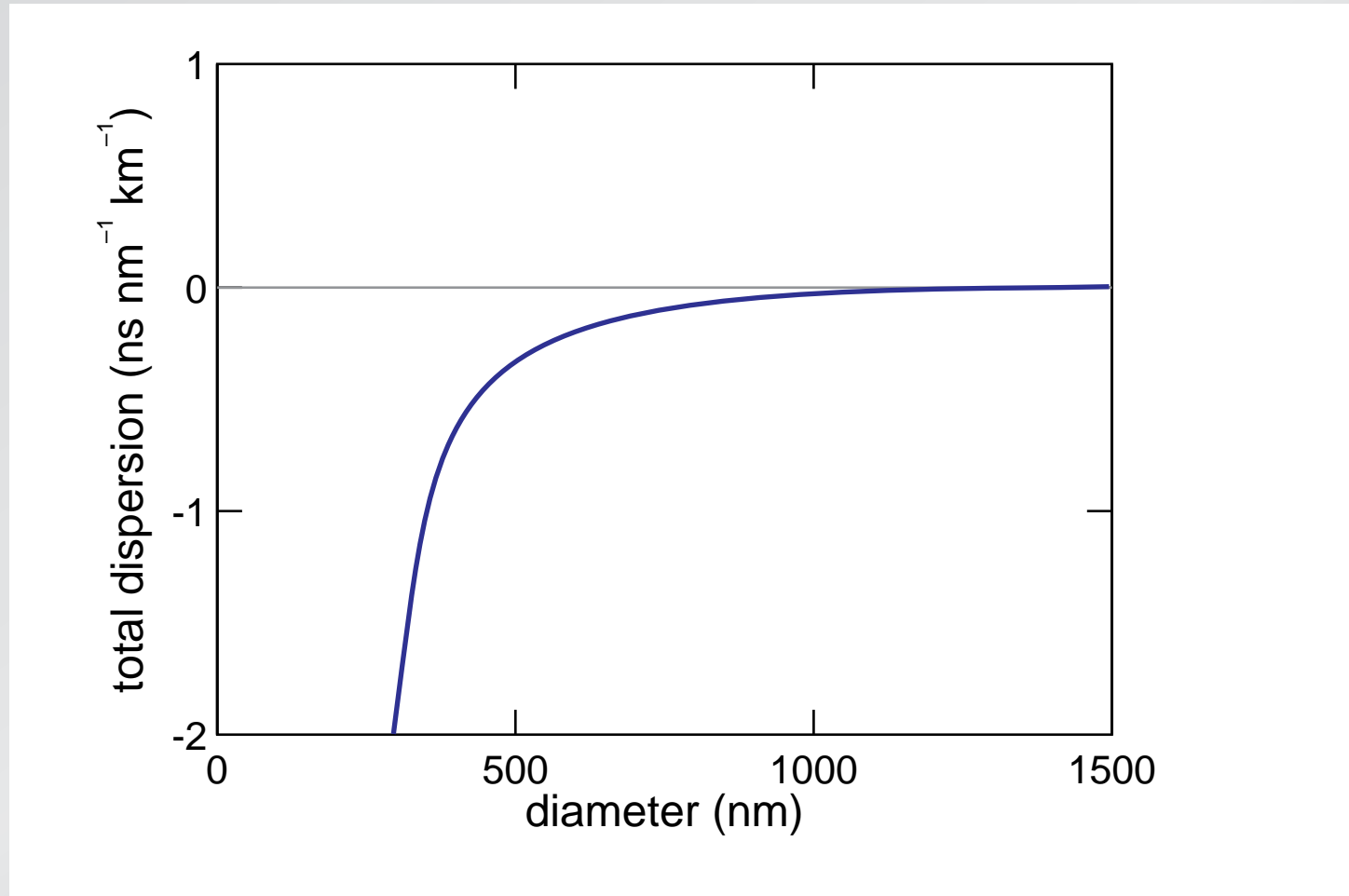

Nonlinear properties

waveguide dispersion

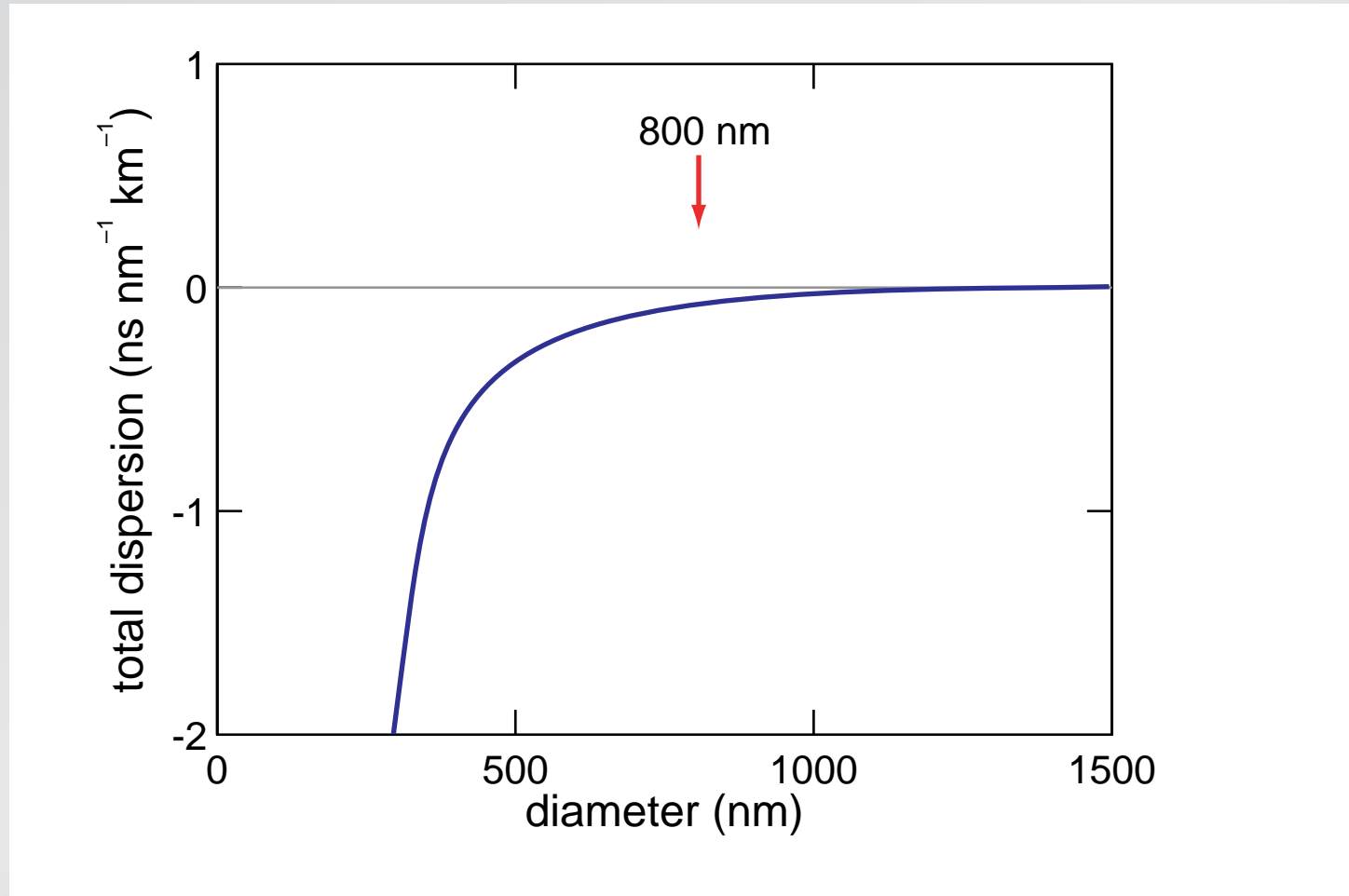

Nonlinear properties

waveguide dispersion

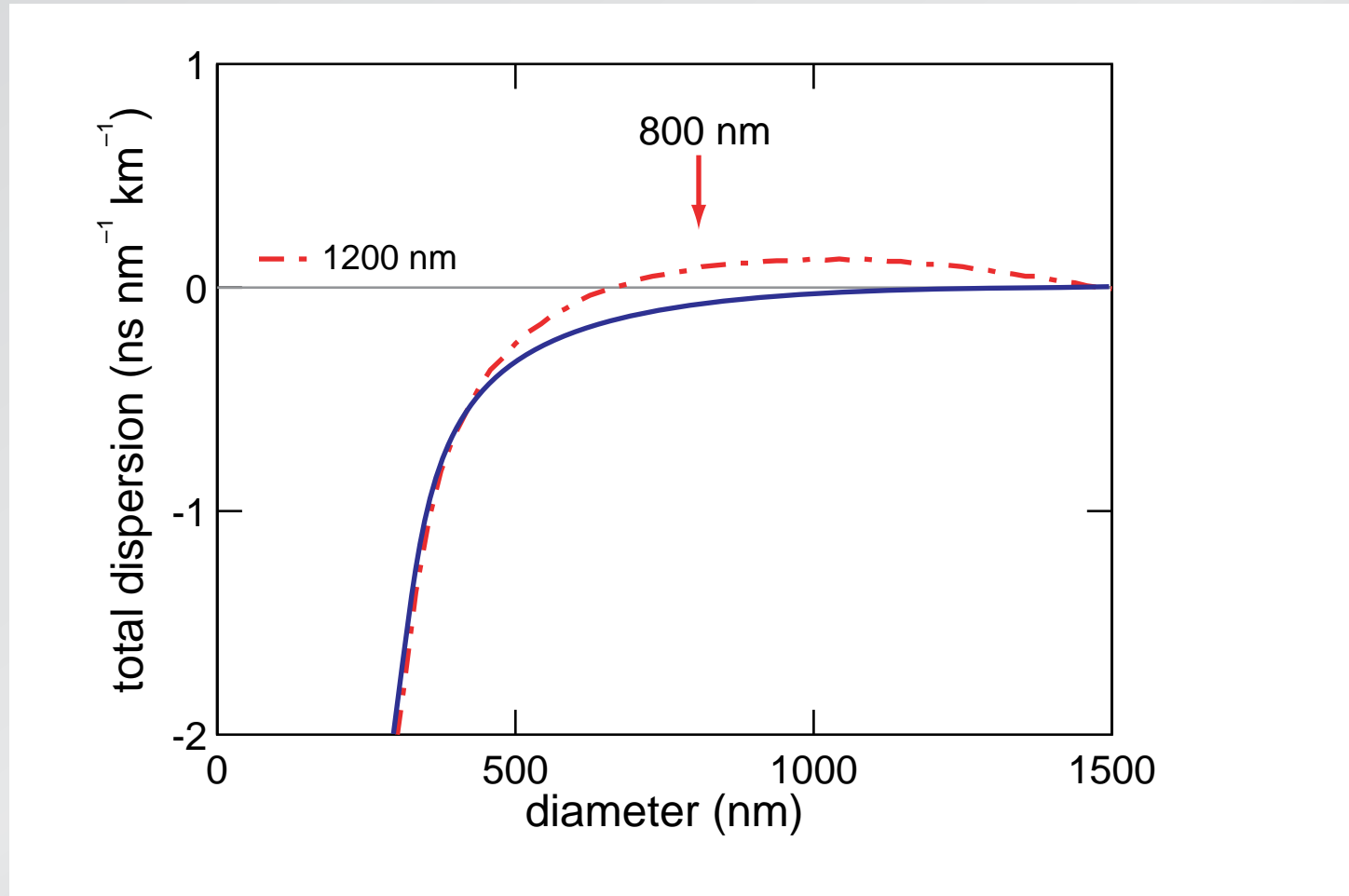

Nonlinear properties

waveguide dispersion

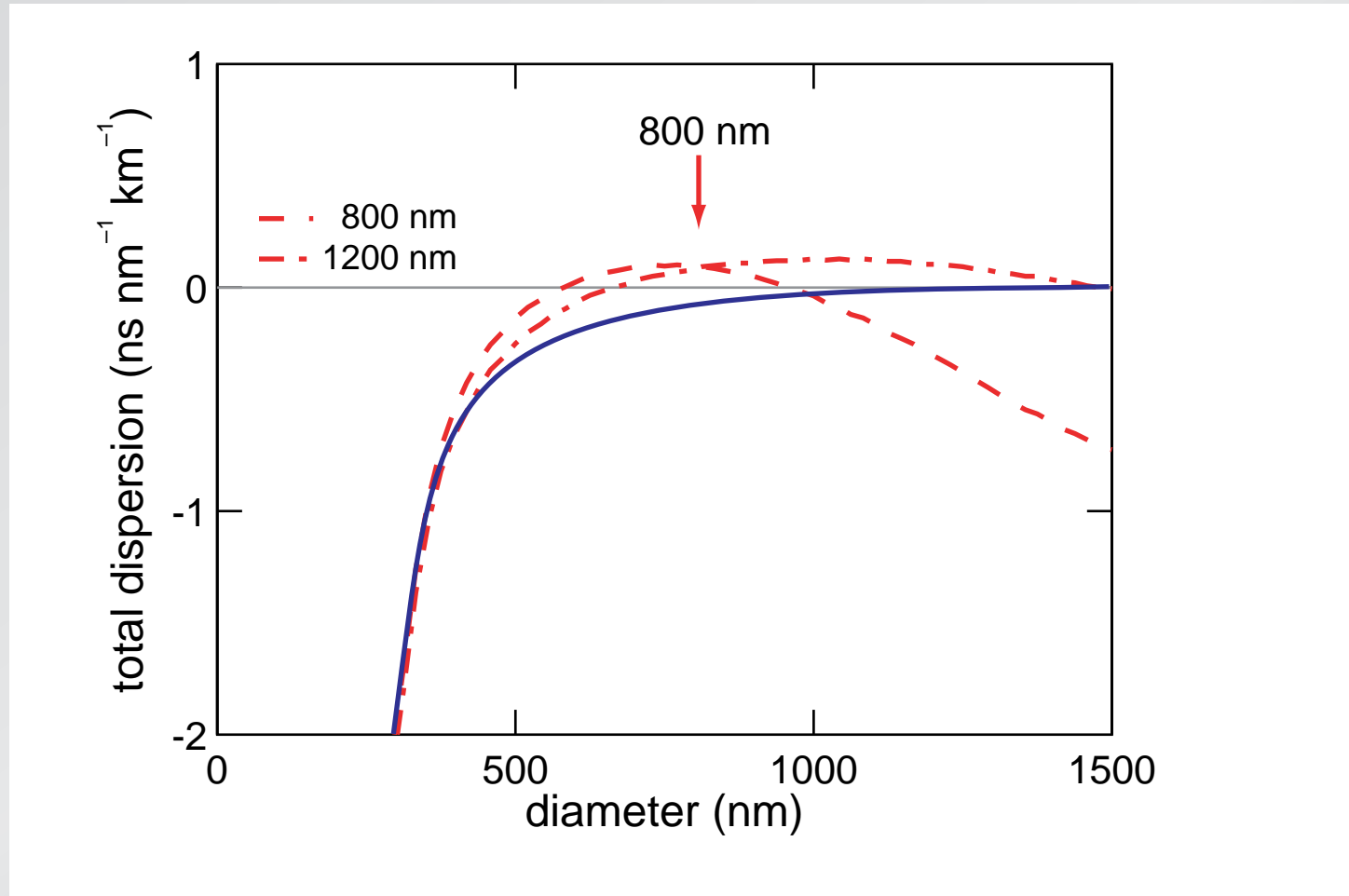

Nonlinear properties

waveguide dispersion

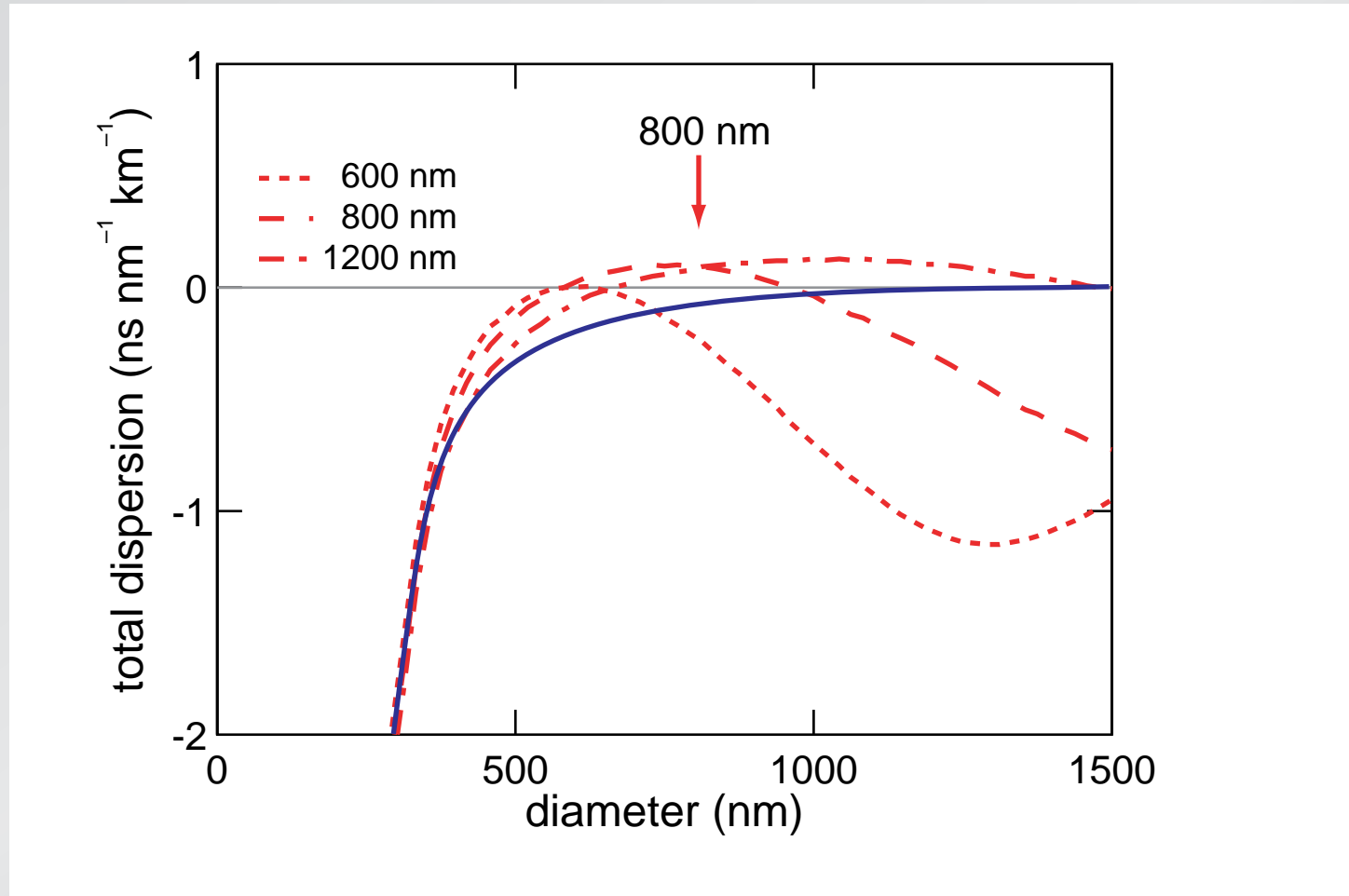

Nonlinear properties

waveguide dispersion

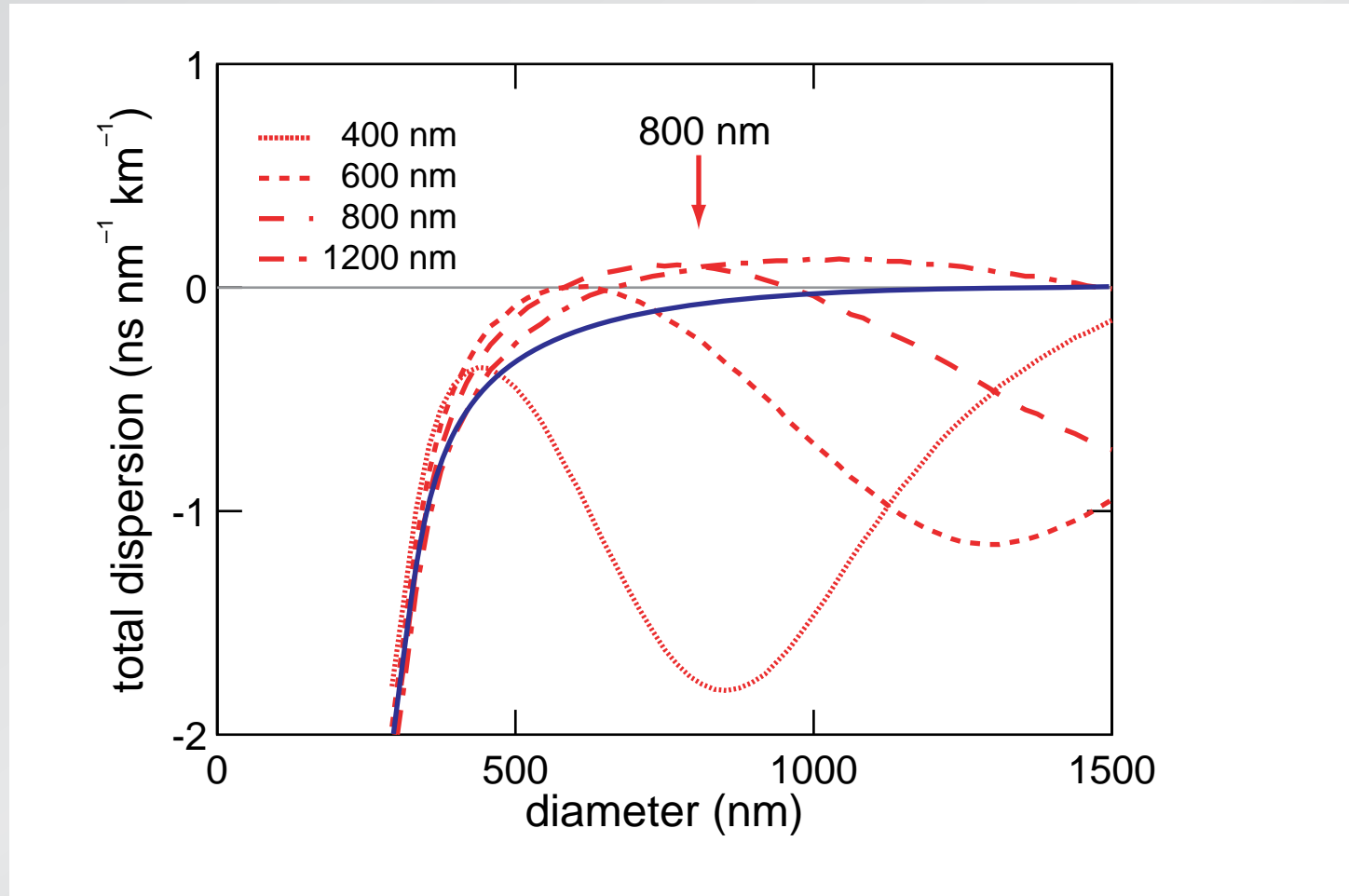

Nonlinear properties

waveguide dispersion

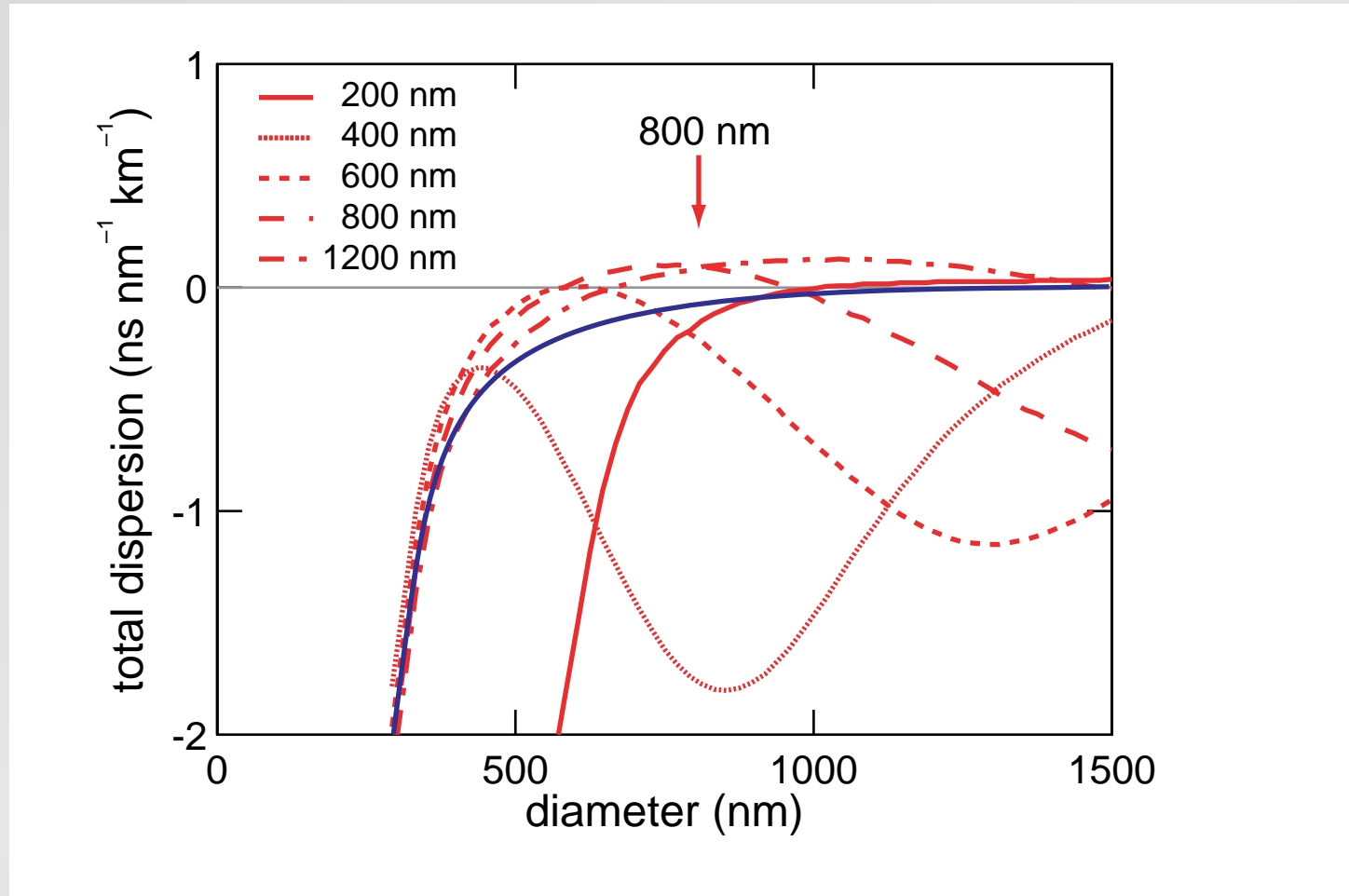

Nonlinear properties

nonlinear parameter

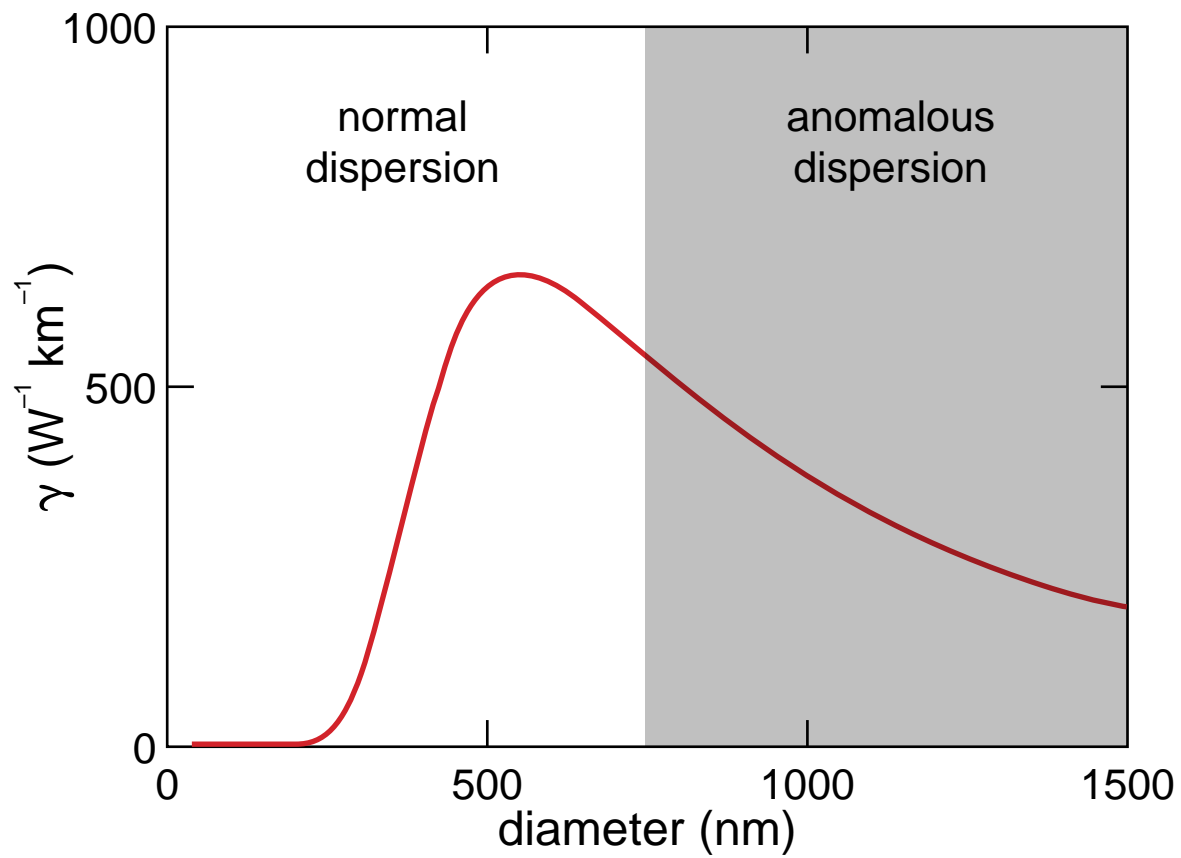

Nonlinear properties

nanowire continuum generation

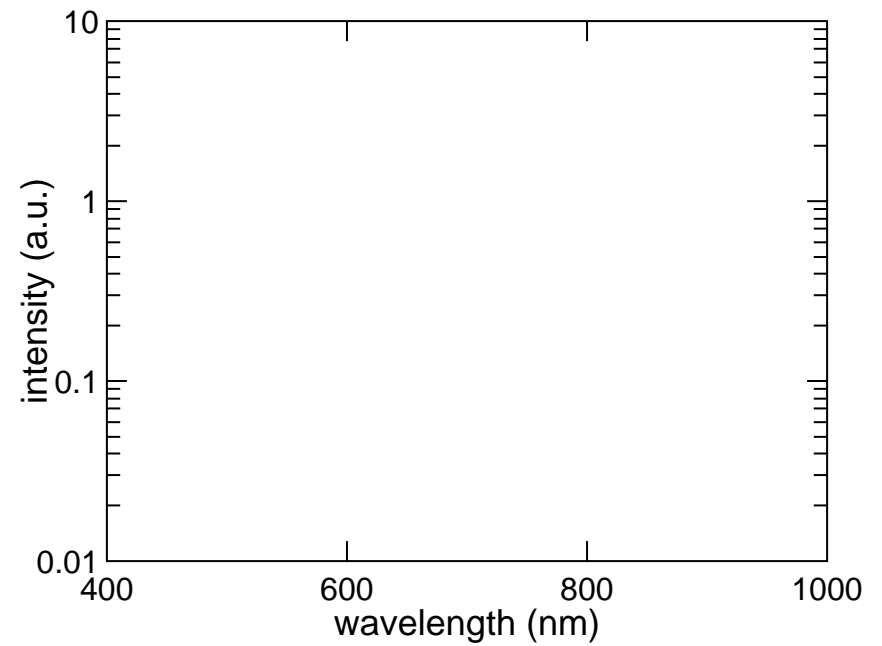
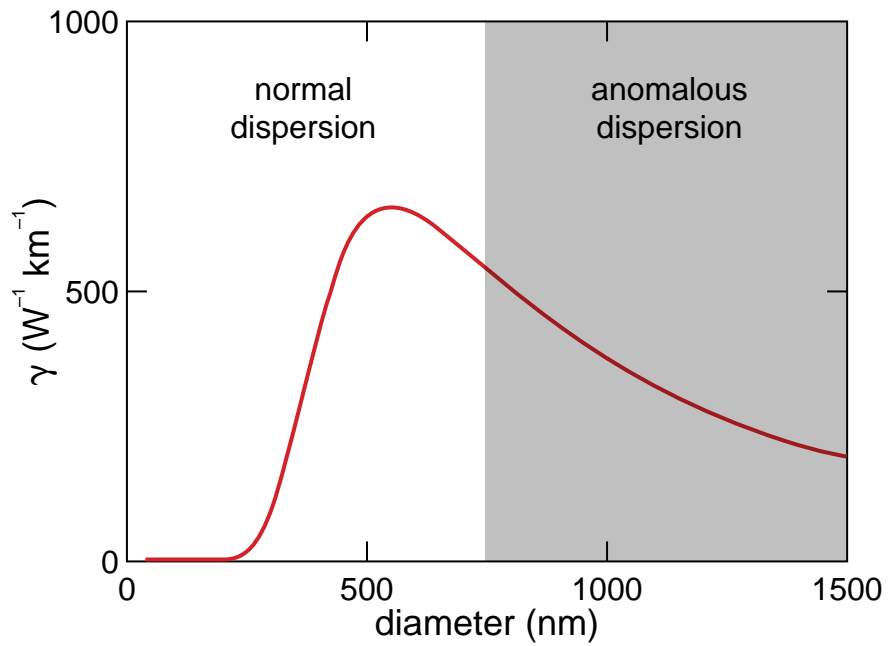

Nonlinear properties

nanowire continuum generation

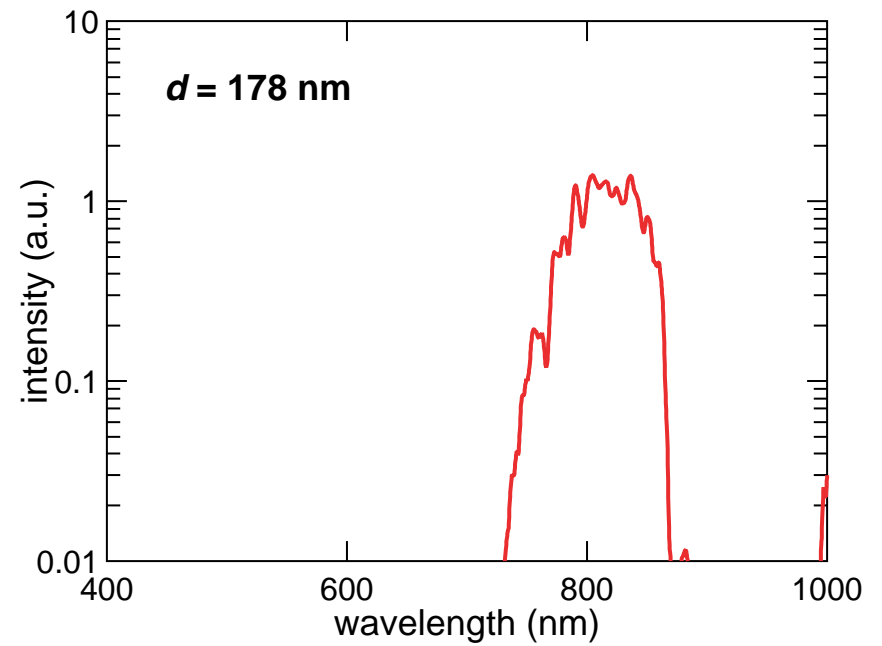
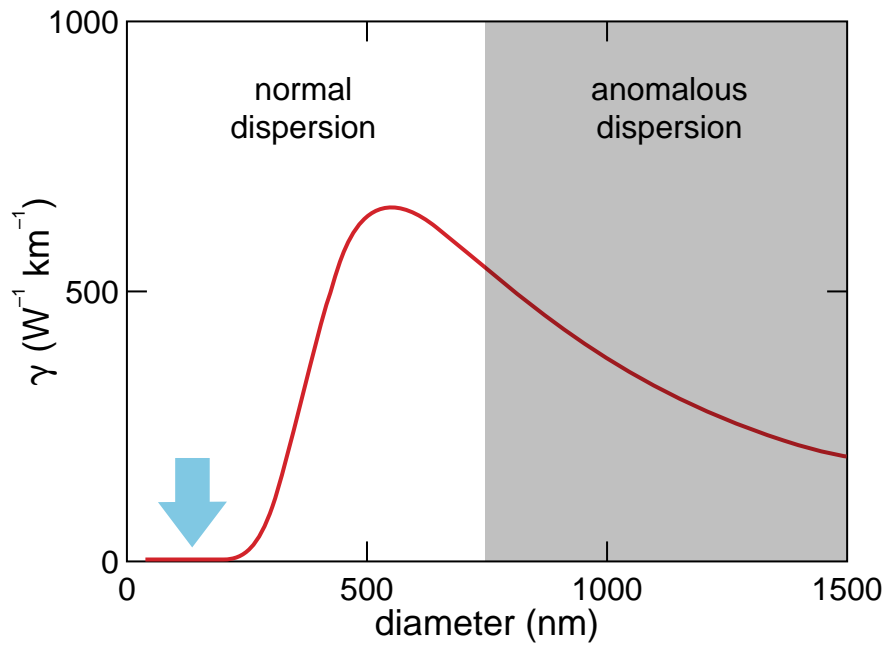

Nonlinear properties

nanowire continuum generation

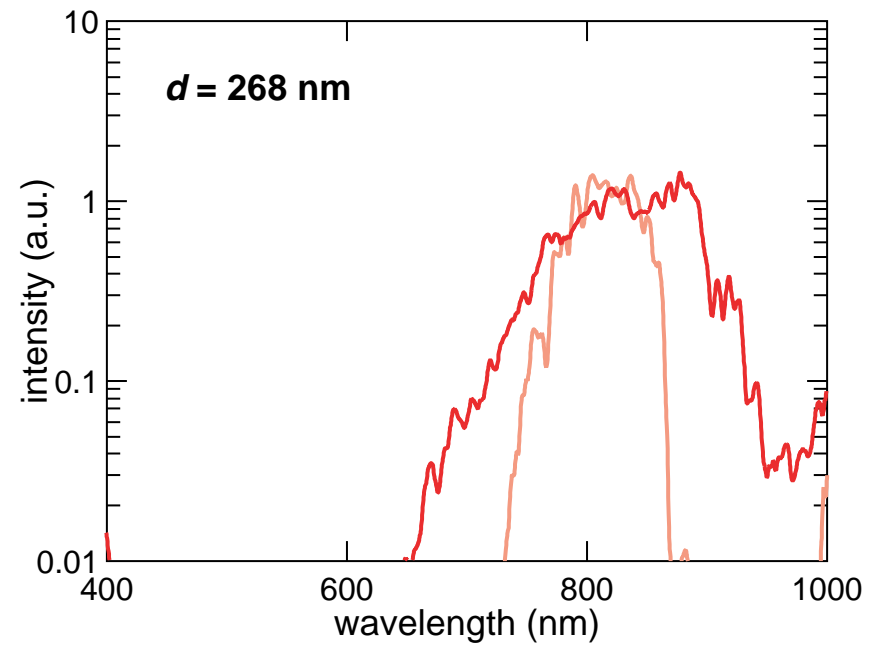
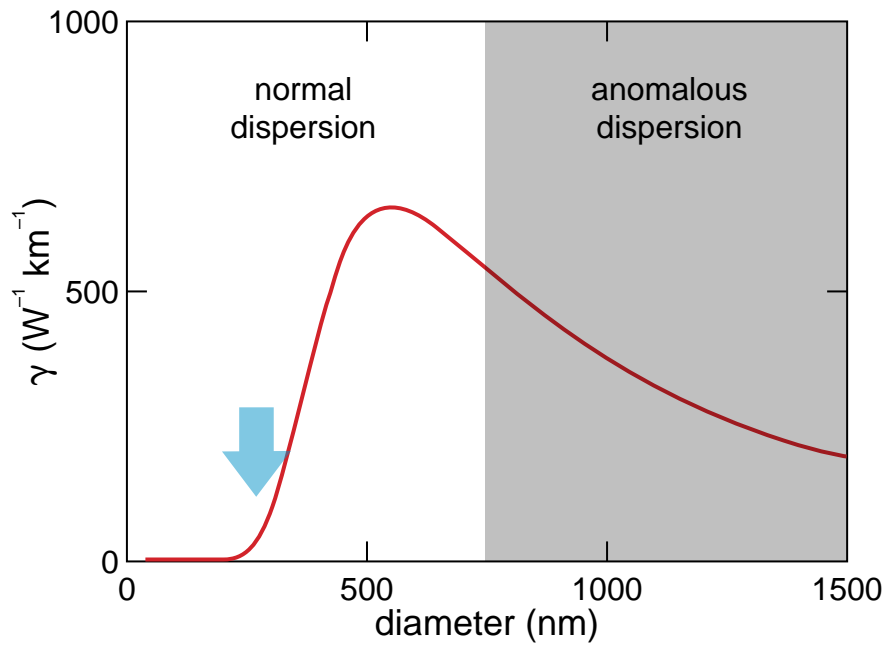

Nonlinear properties

nanowire continuum generation

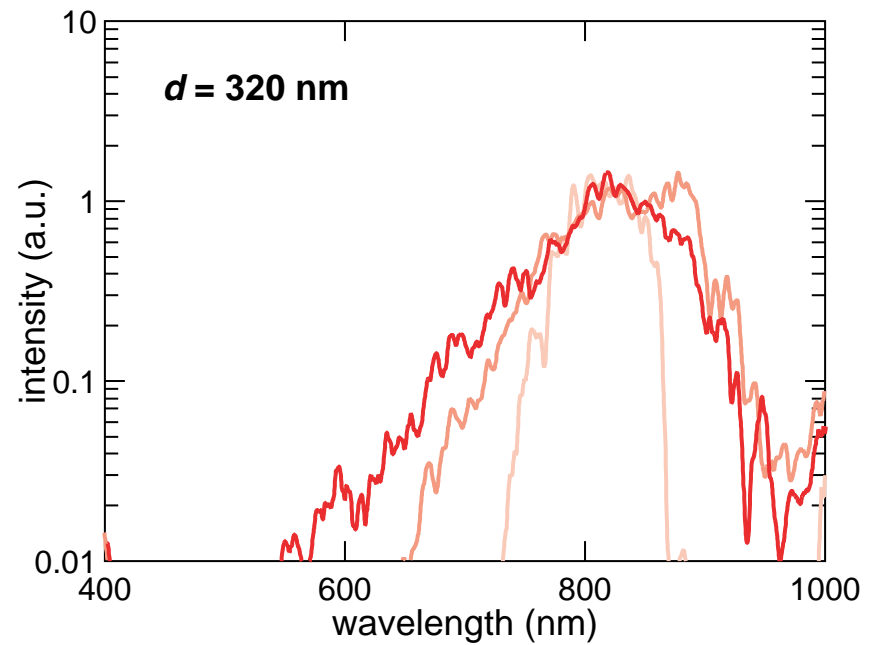
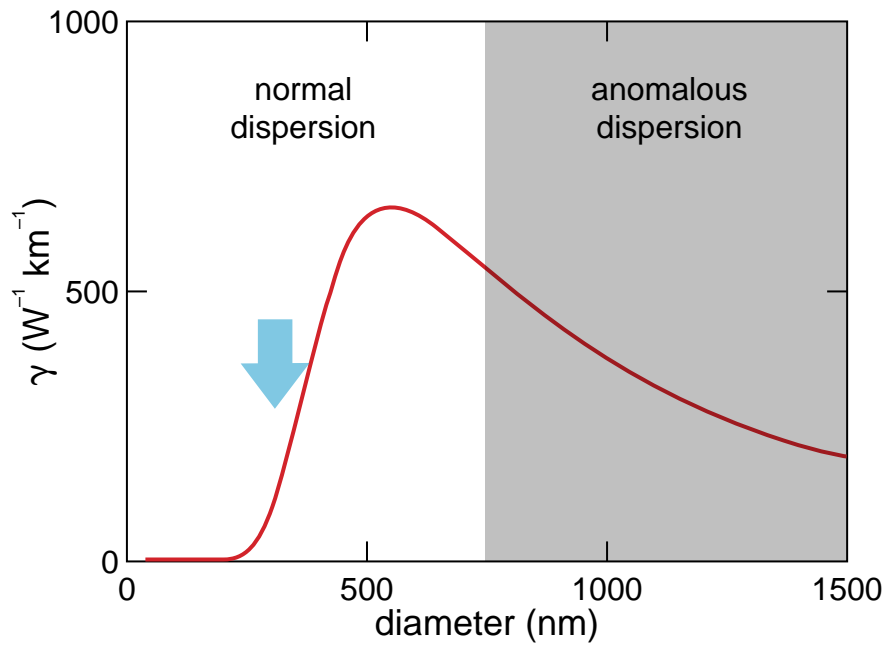

Nonlinear properties

nanowire continuum generation

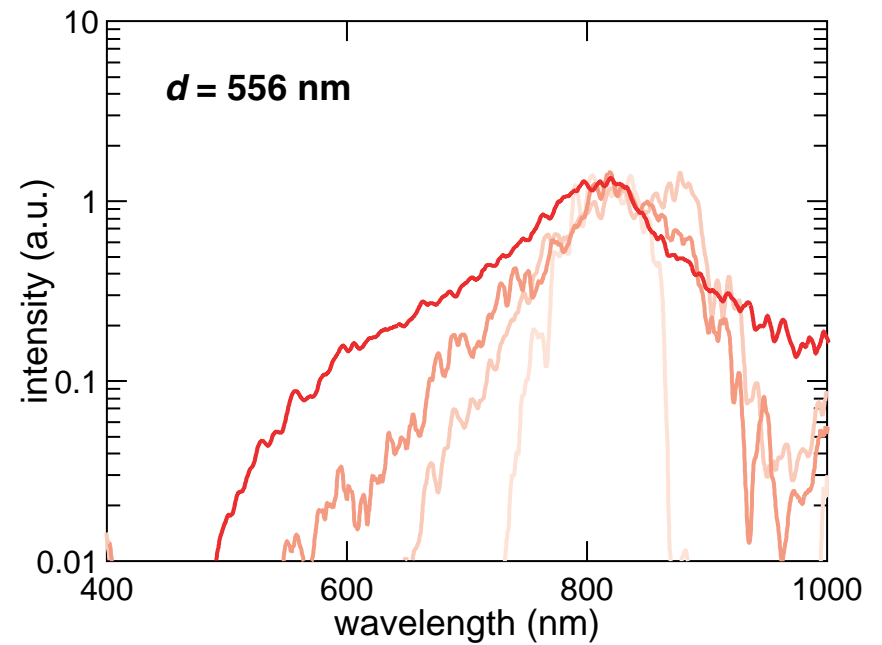
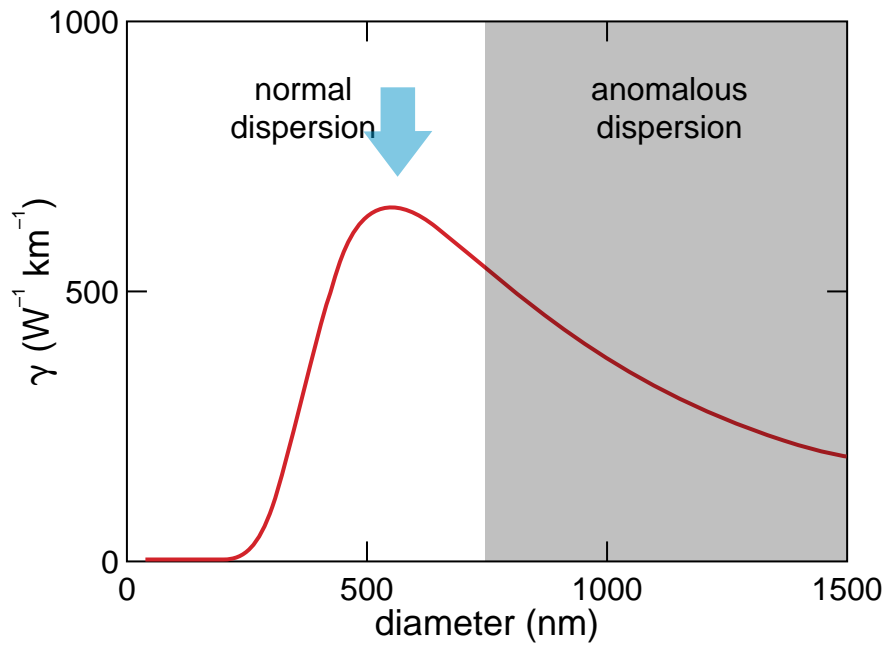

Nonlinear properties

nanowire continuum generation

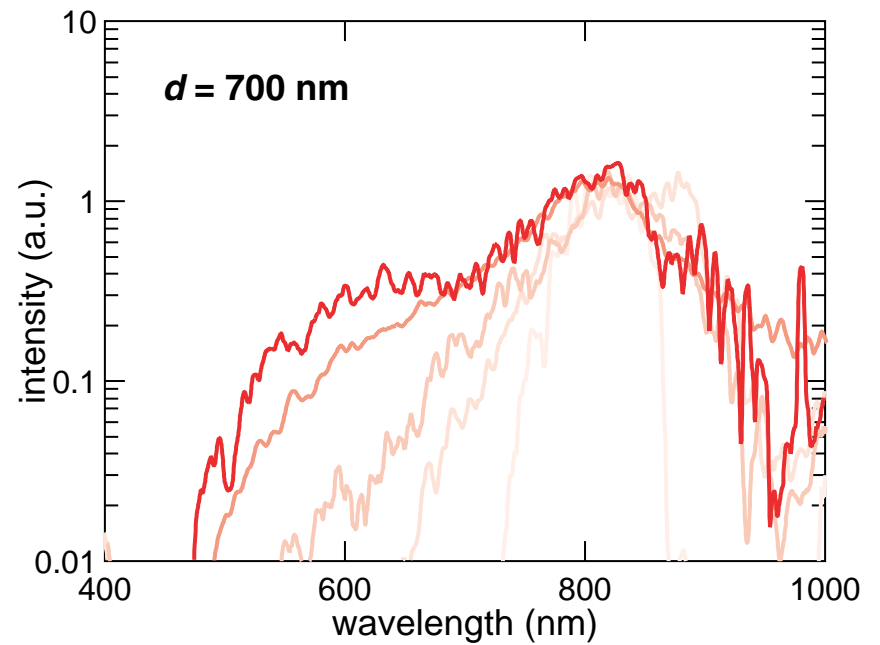
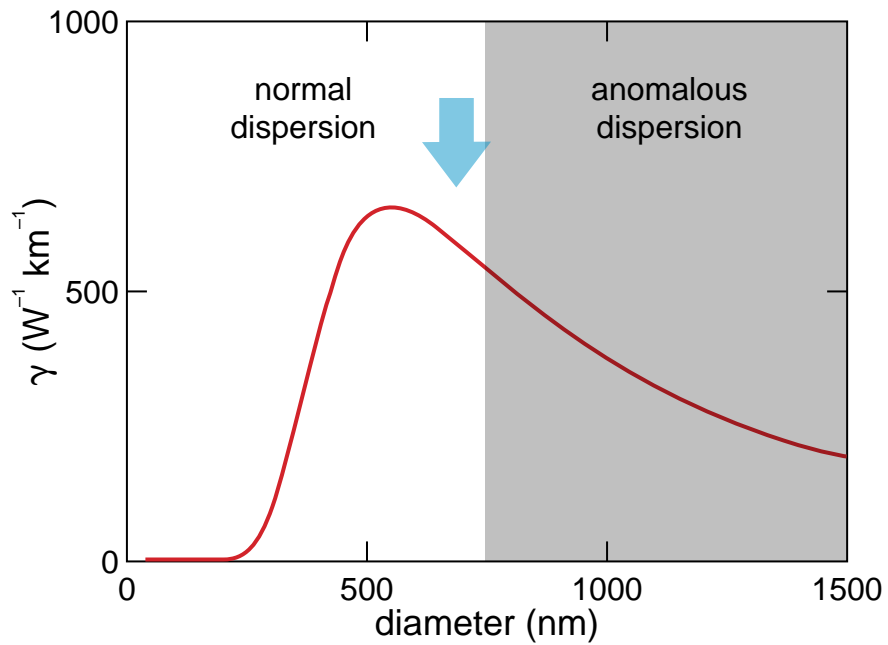

Nonlinear properties

nanowire continuum generation

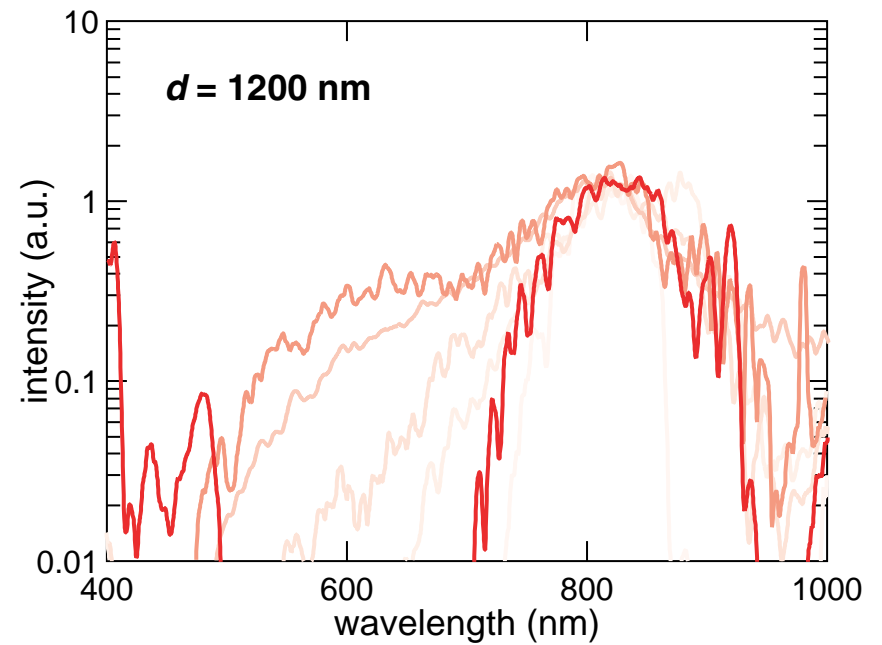
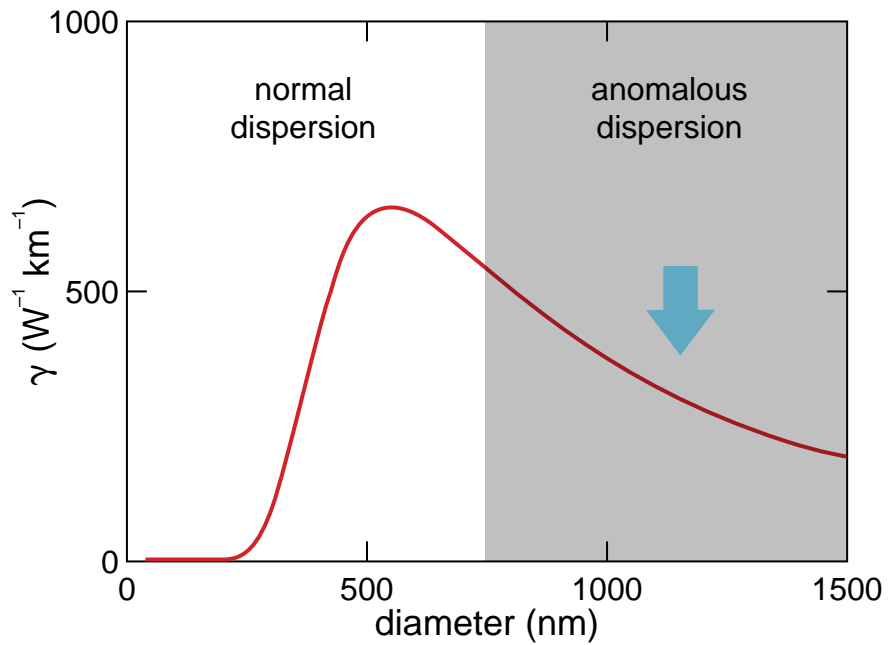

Nonlinear properties

energy in nanowire < 100 pJ!

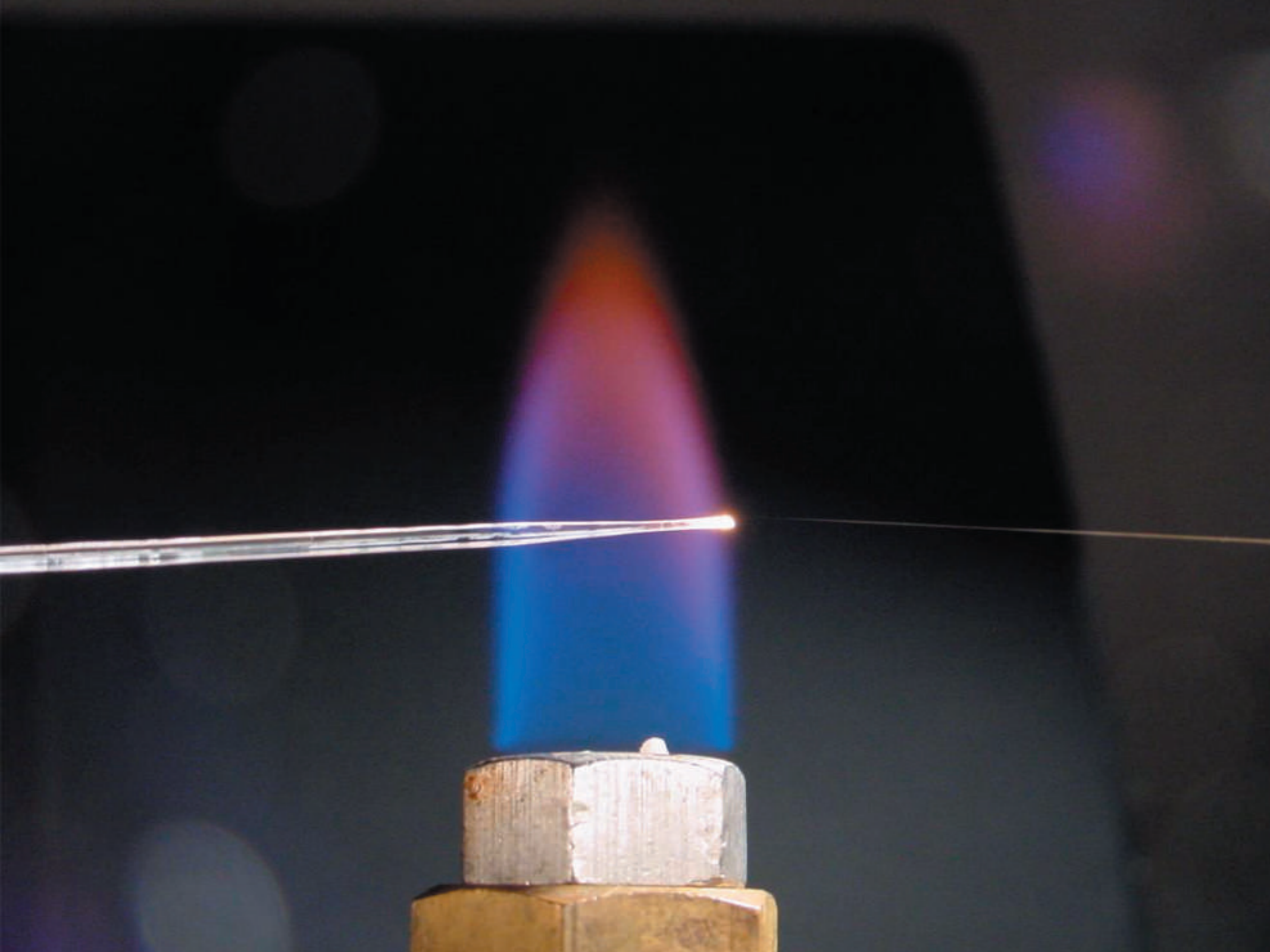

Summary

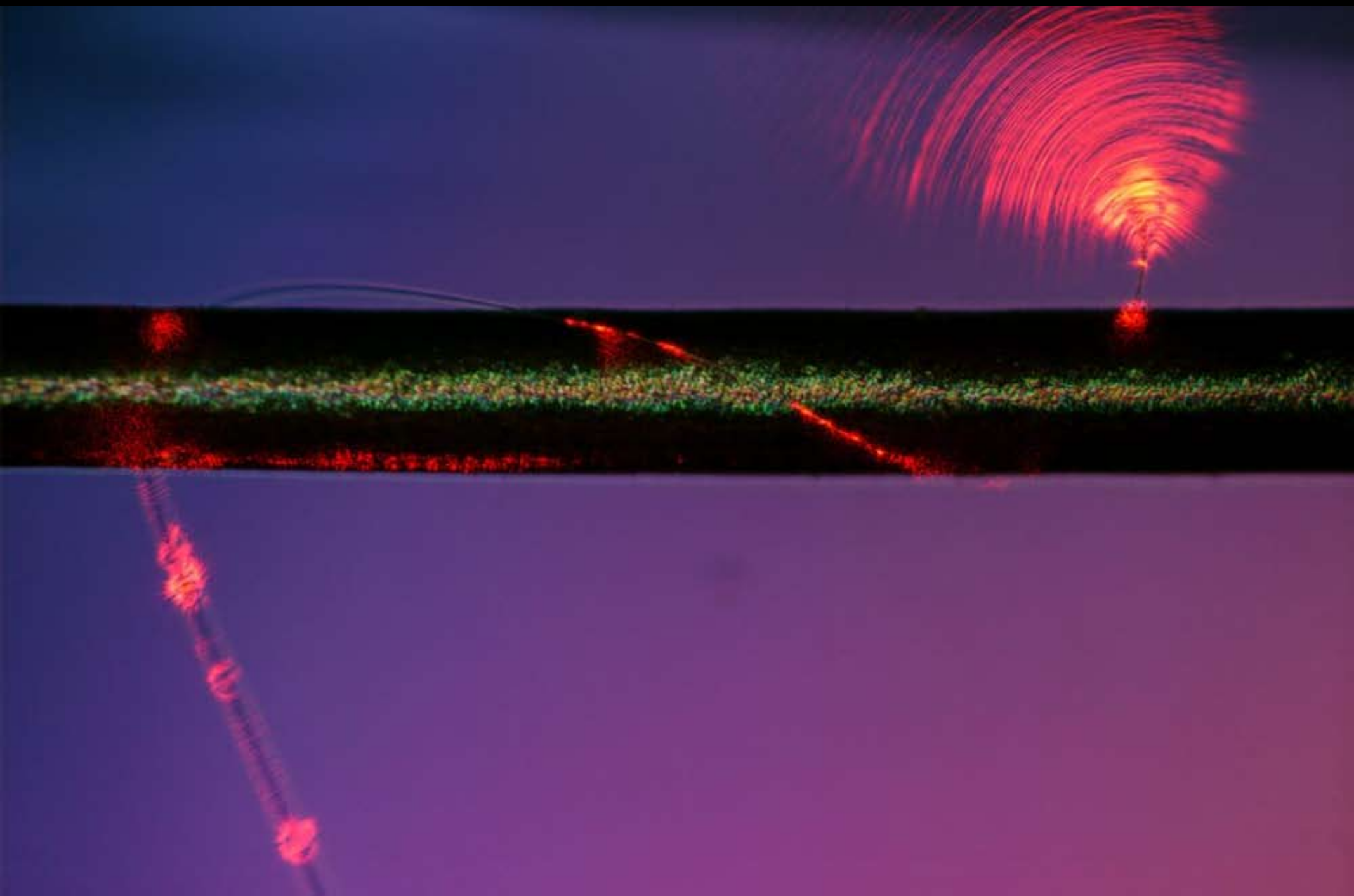

Summary

- nanotechnology on a nanobudget

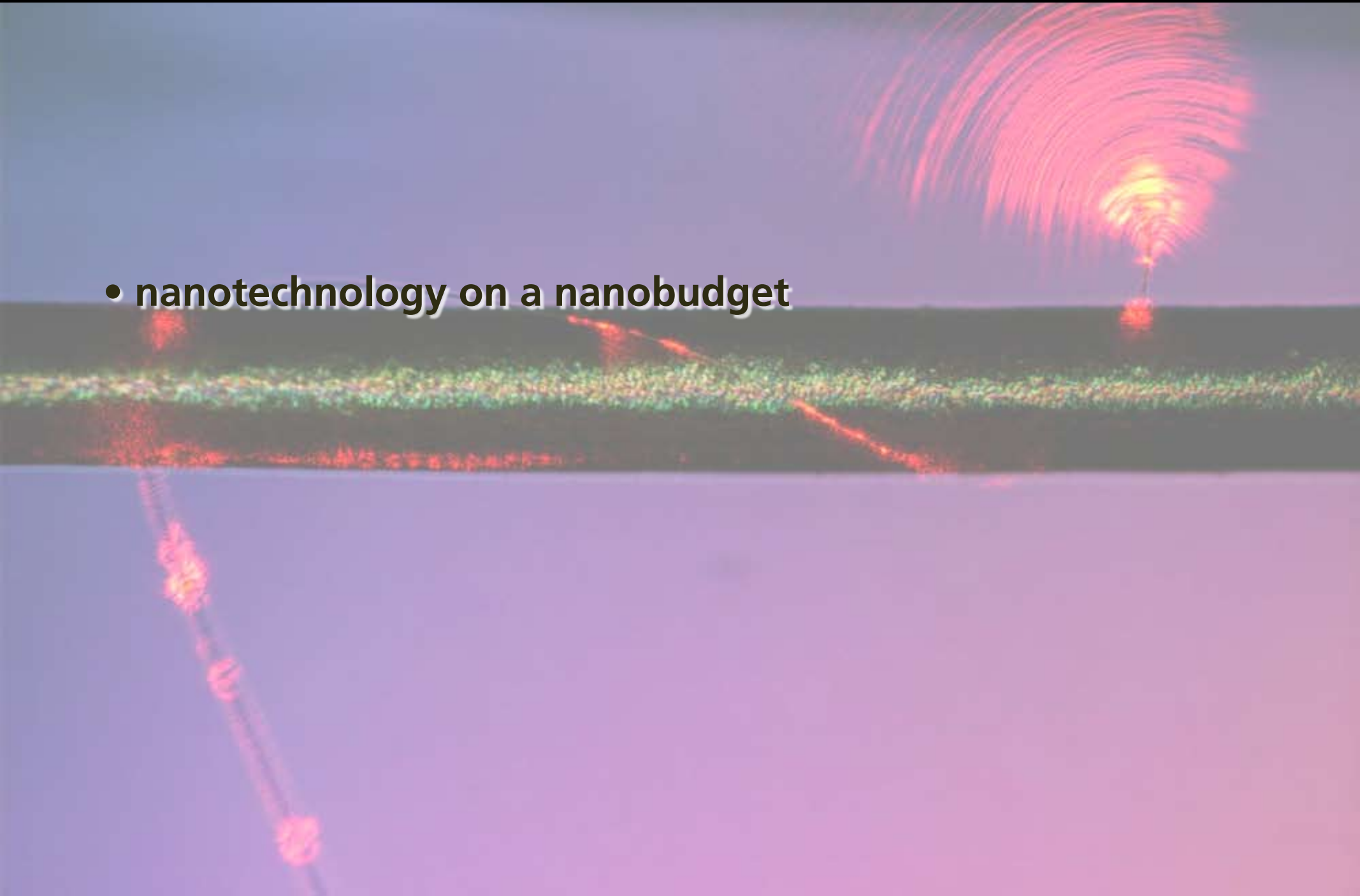

Summary

- nanotechnology on a nanobudget
- submicrometer confinement



Summary

- nanotechnology on a nanobudget
- submicrometer confinement
- subnanojoule nonlinear optics

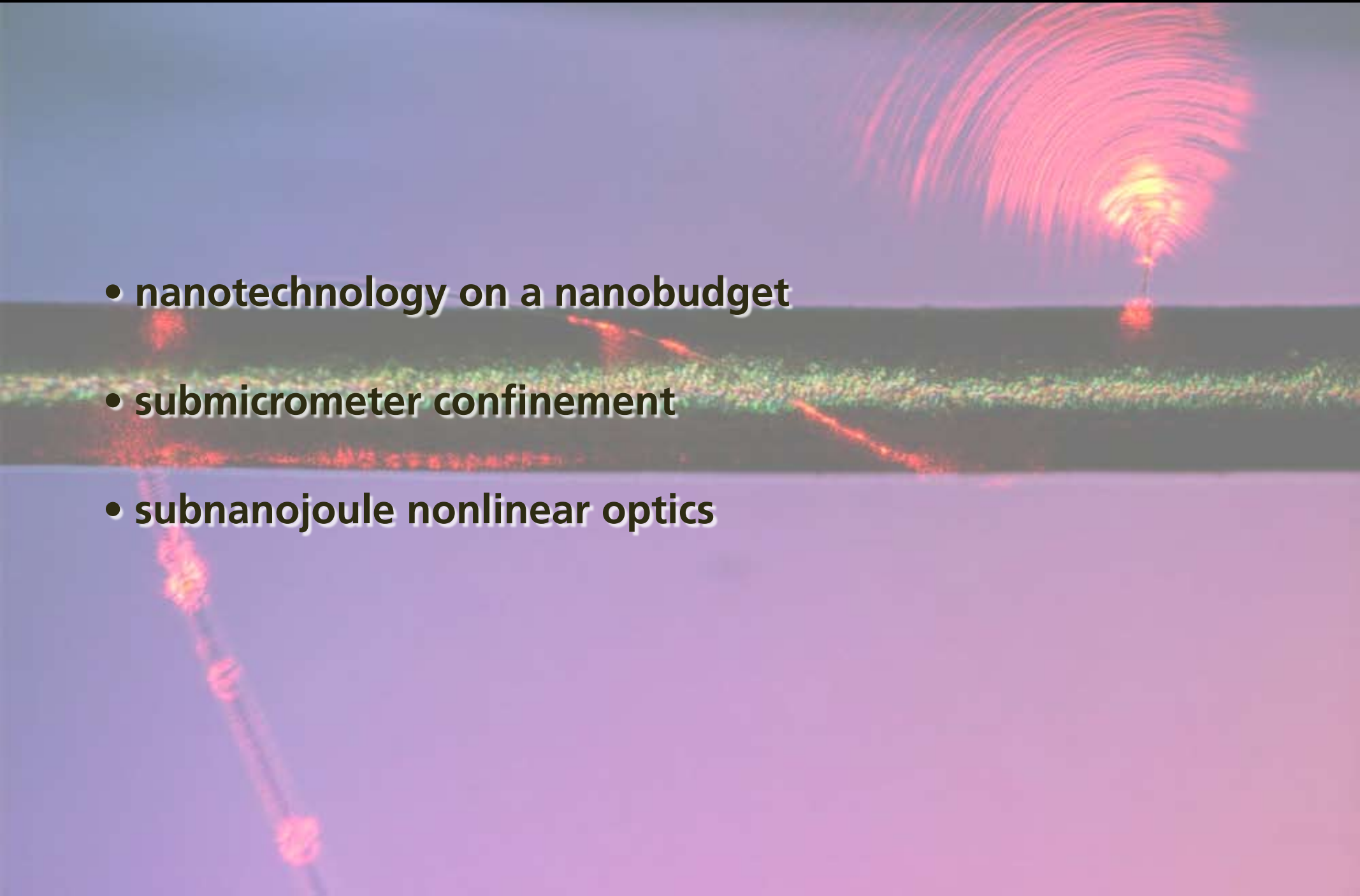

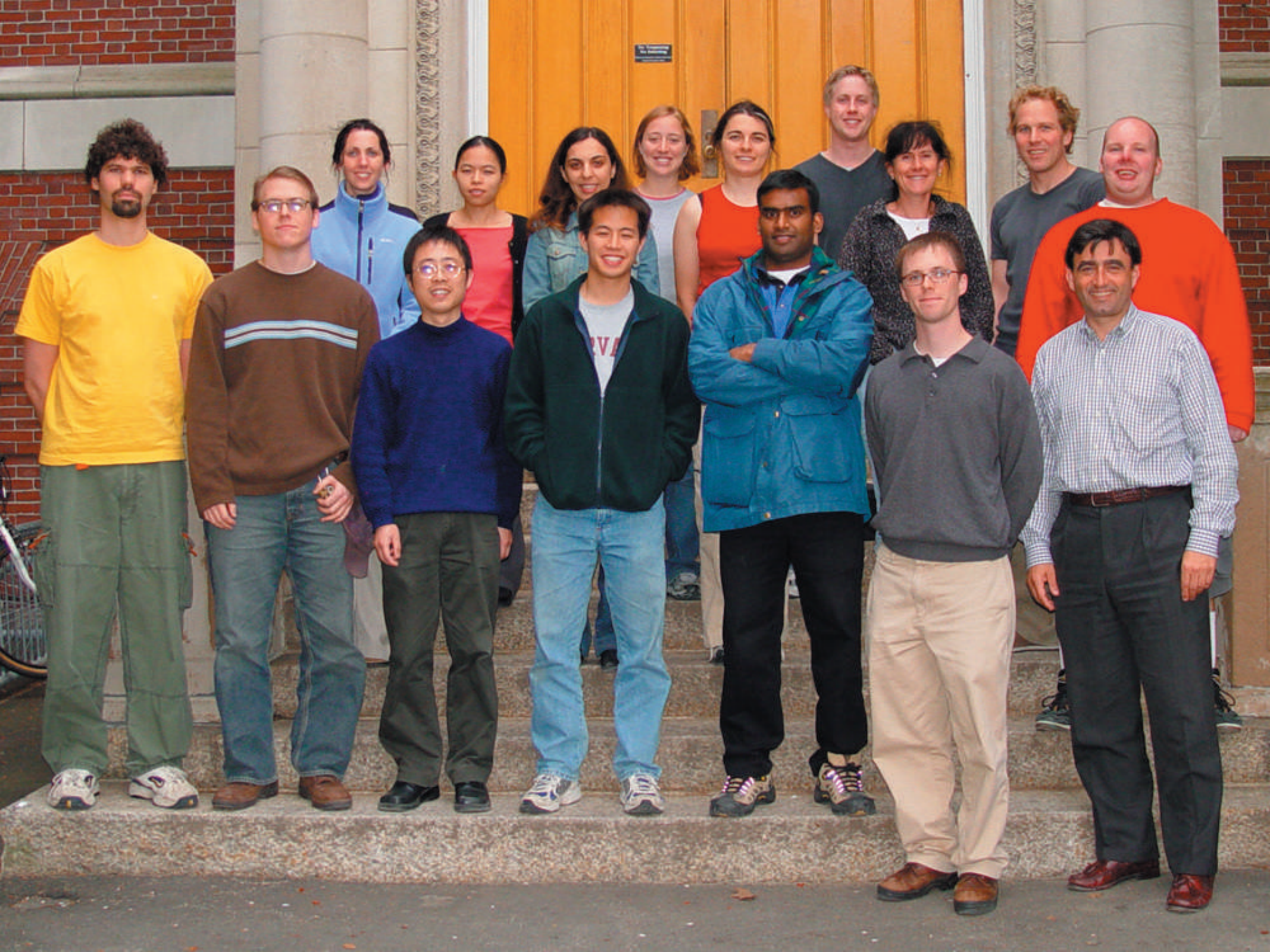



Funding:

**Harvard Center for Imaging and Mesoscopic Structures
National Science Foundation
National Natural Science Foundation of China**

for a copy of this presentation:

<http://mazur-www.harvard.edu>

Google™

Google Search

I'm Feeling Lucky

Google™

mazur

Google Search

I'm Feeling Lucky

Google™

Google Search

I'm Feeling Lucky

Google™

mazur

Google Search

I'm Feeling Lucky



Funding:

**Harvard Center for Imaging and Mesoscopic Structures
National Science Foundation
National Natural Science Foundation of China**

for a copy of this presentation:

<http://mazur-www.harvard.edu>