

Confessions of a converted lecturer



2007 Teaching and Learning Conference
University of Minnesota
Minneapolis, MN, 23 April 2007



My message

shift focus from "teaching" to helping students learn



Outline

- Education



Outline

- Education
- Peer Instruction



Outline

- Education
- Peer Instruction
- Results



Education



Education

lectures focus on delivery of information

A wide-angle photograph of a large lecture hall. The room is filled with students seated at rows of desks, all facing towards the front. At the front of the room, a lecturer is standing at a podium, addressing the class. Behind the lecturer is a large projection screen displaying text. The walls are a light blue color, and the overall atmosphere is that of a formal educational setting.

Education

education is not just information transfer

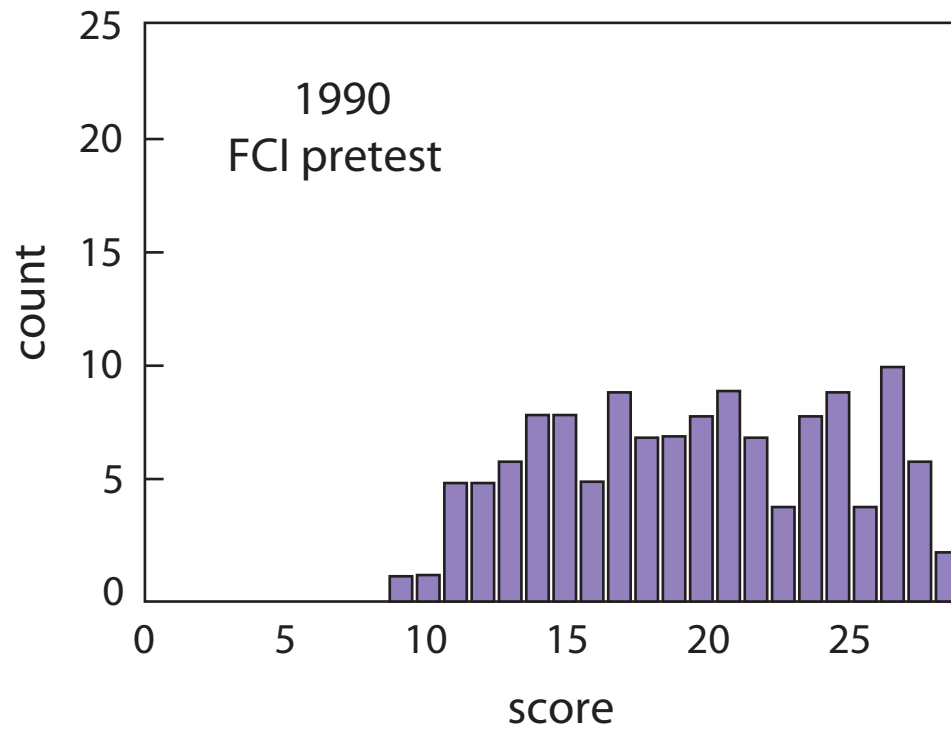

Education

education is not just information transfer

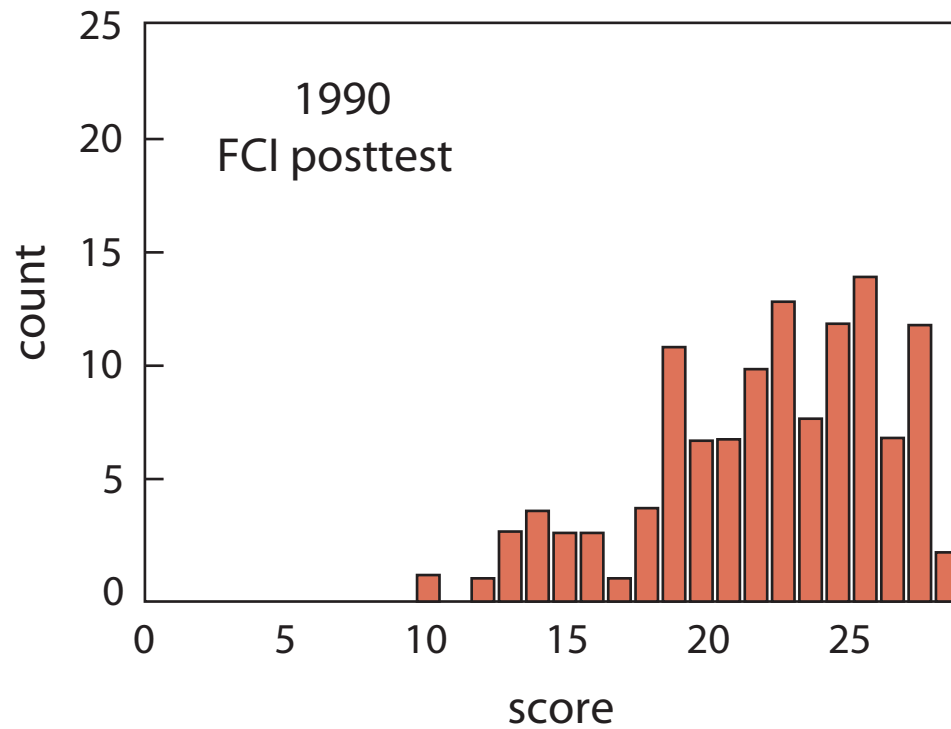

Education

education is not just information transfer

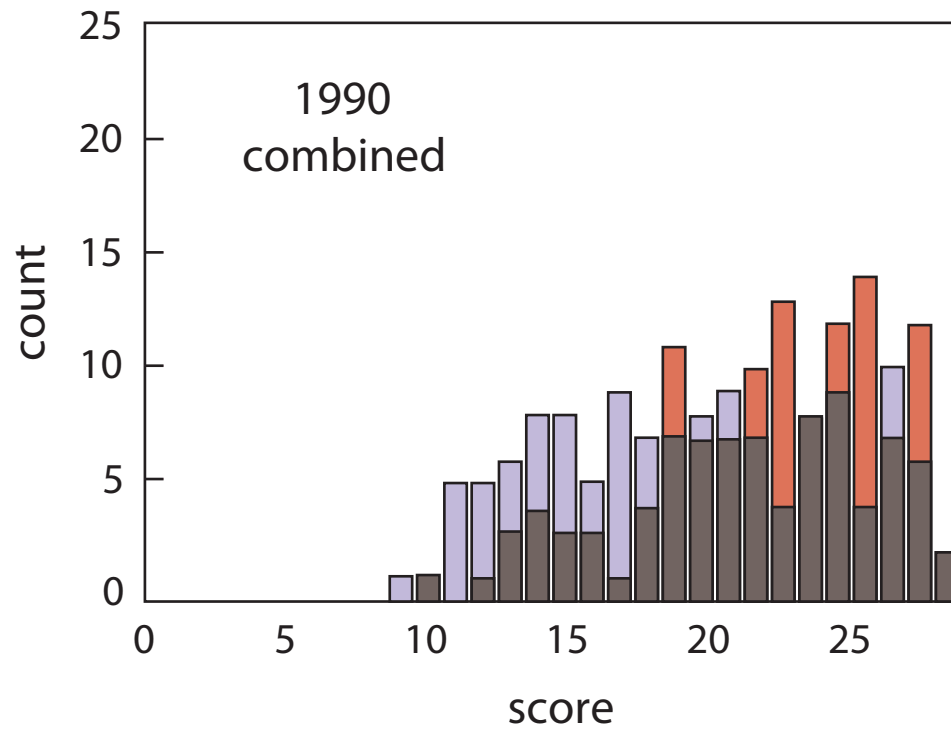

Education

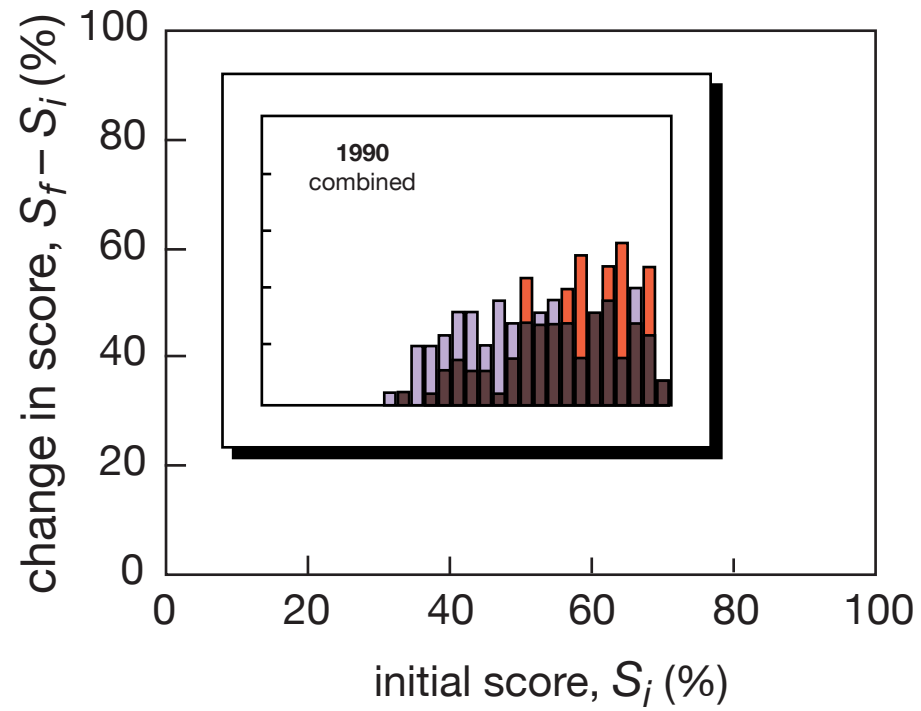

Education

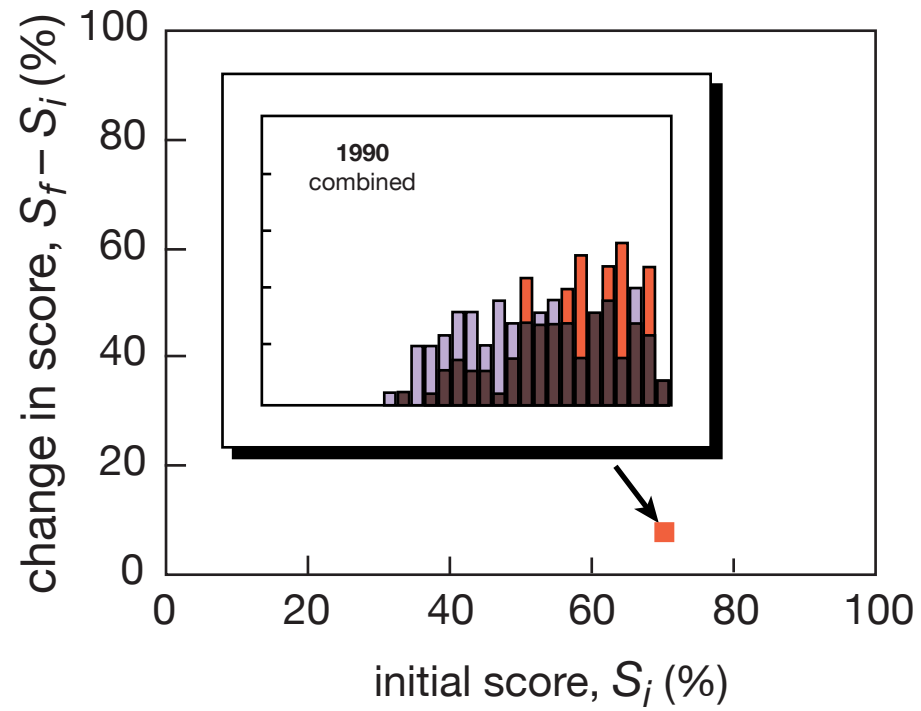

Education

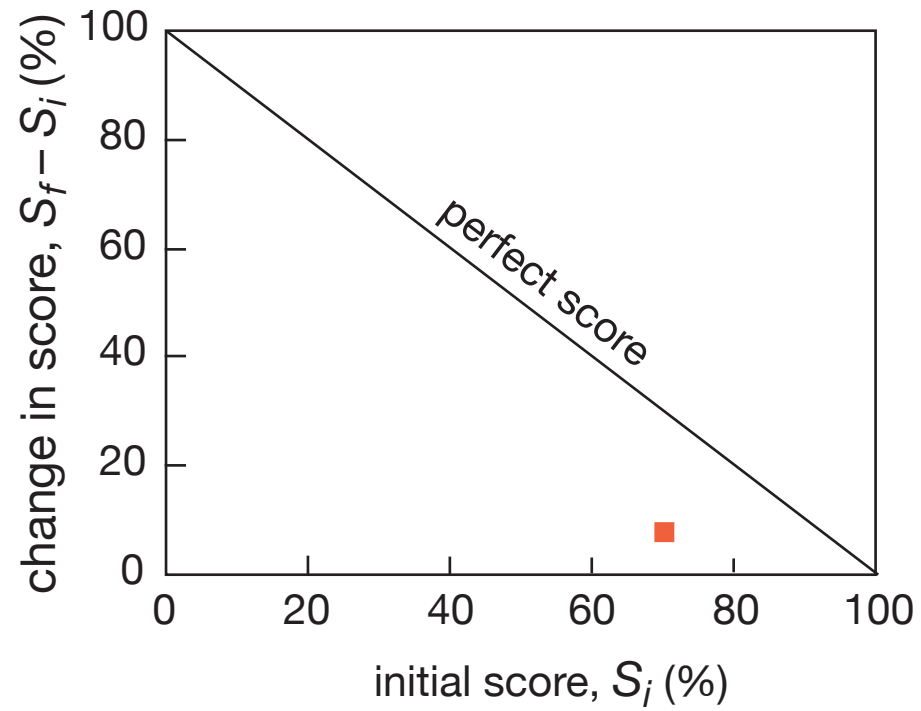

Education

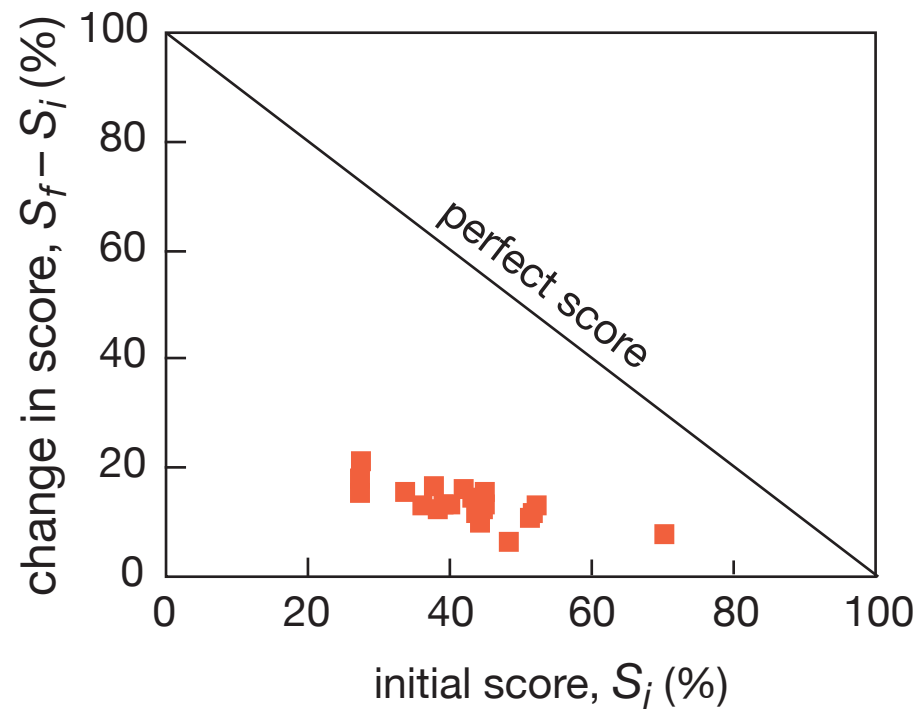

Education

only one quarter of maximum gain realized

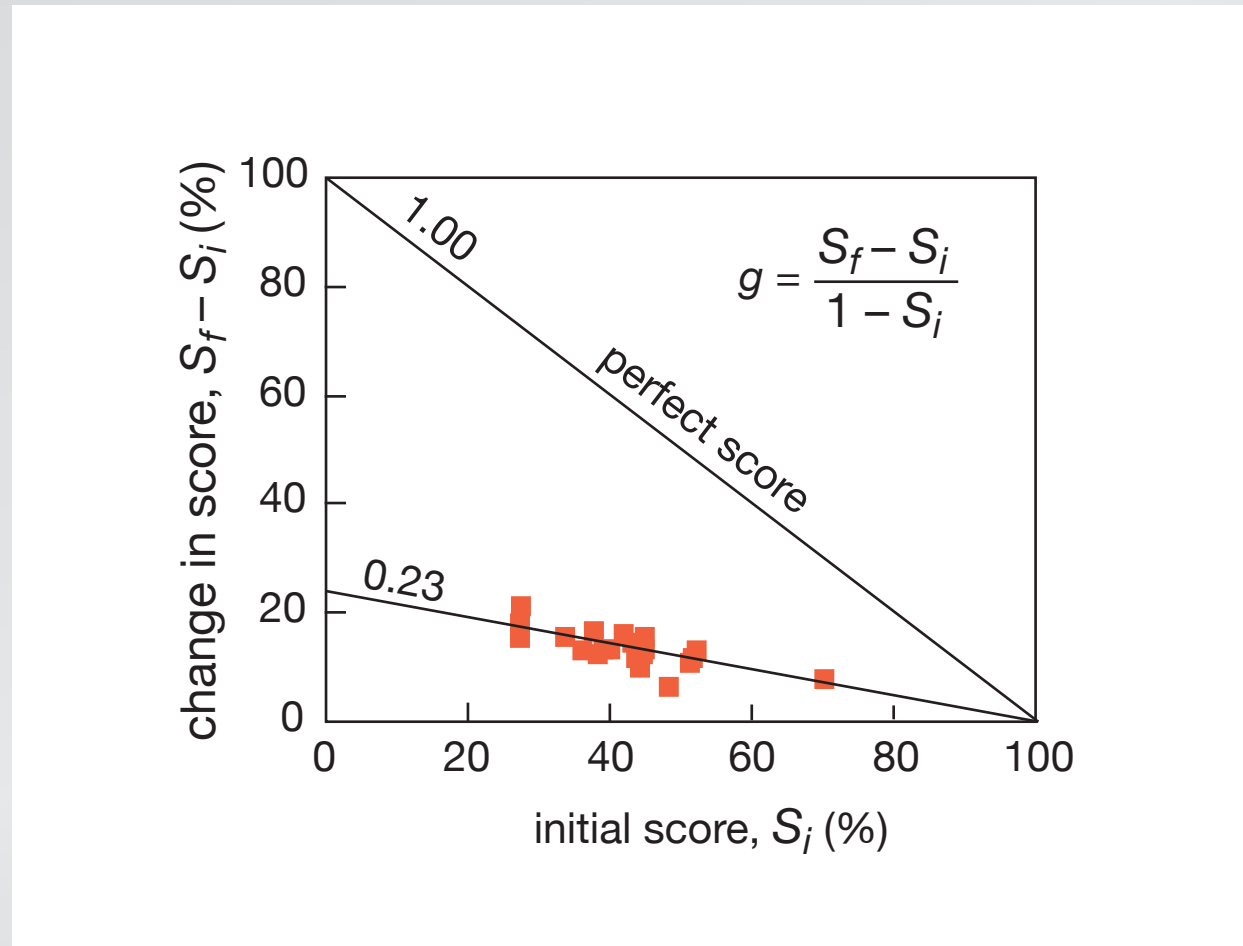

Education

not transfer but assimilation of information is key

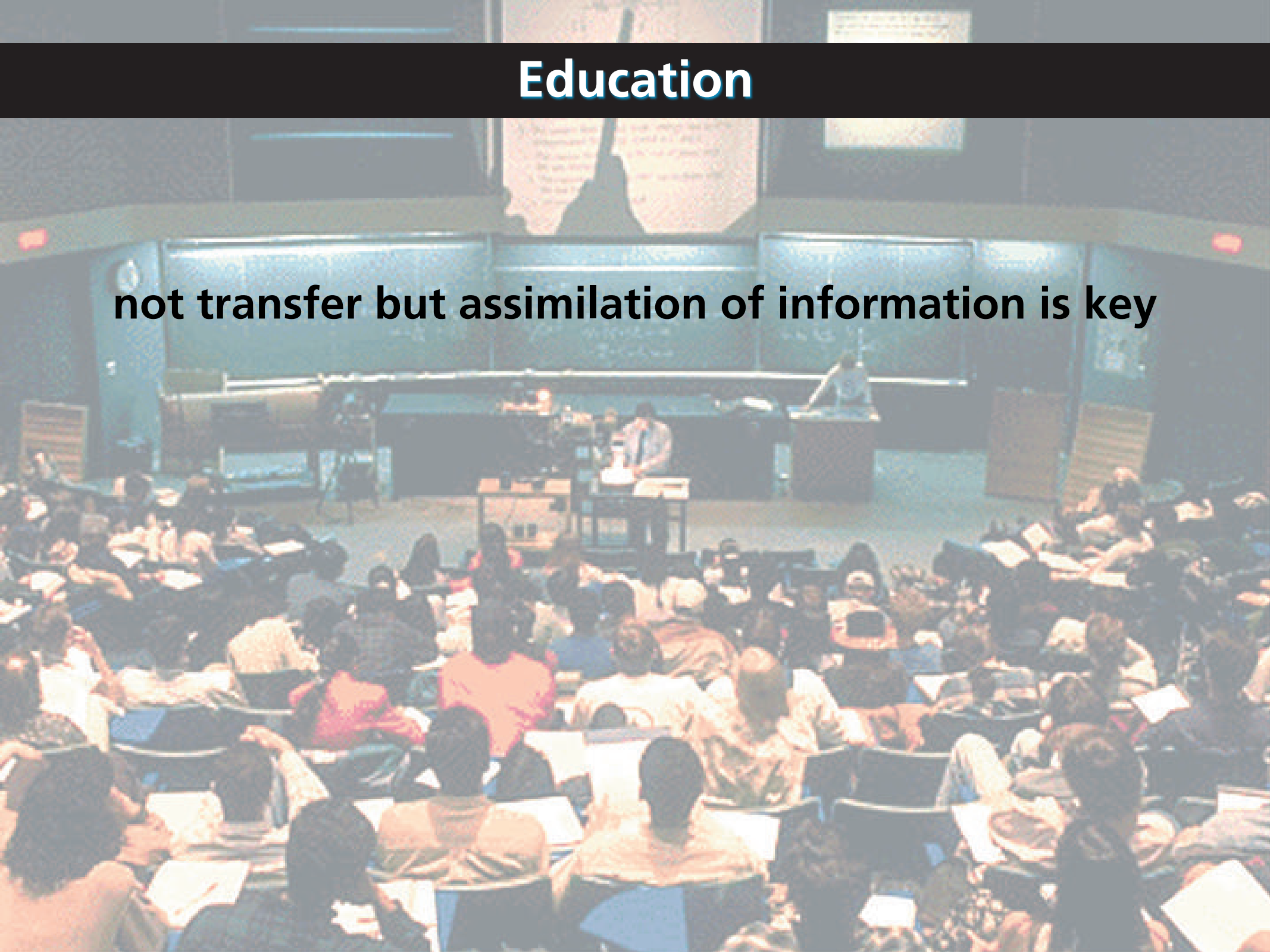

Education

conventional problems misleading

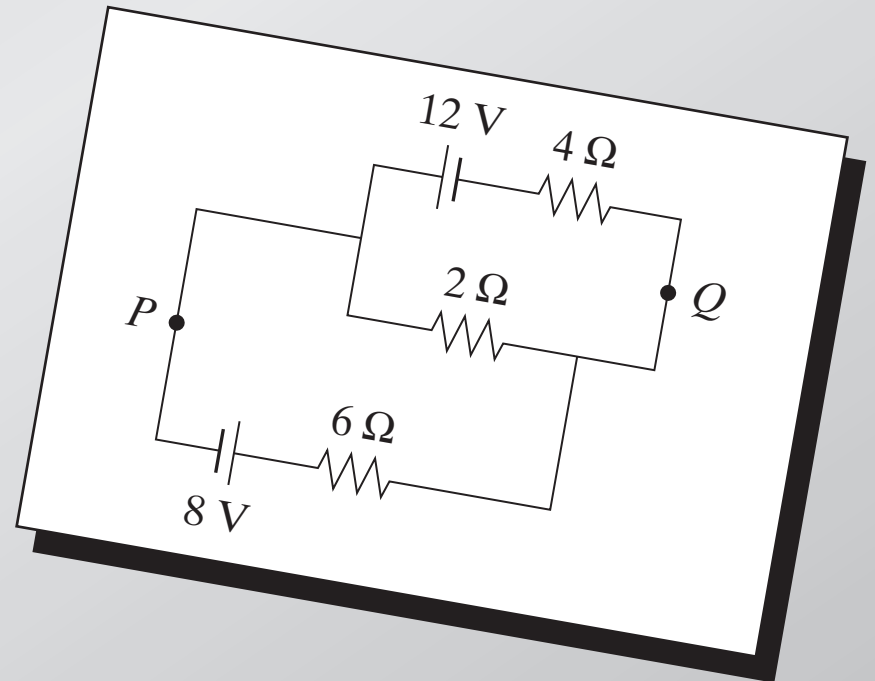

Education

conventional problems misleading

Calculate:

(a) current in 2- Ω resistor

(b) potential difference

between P and Q

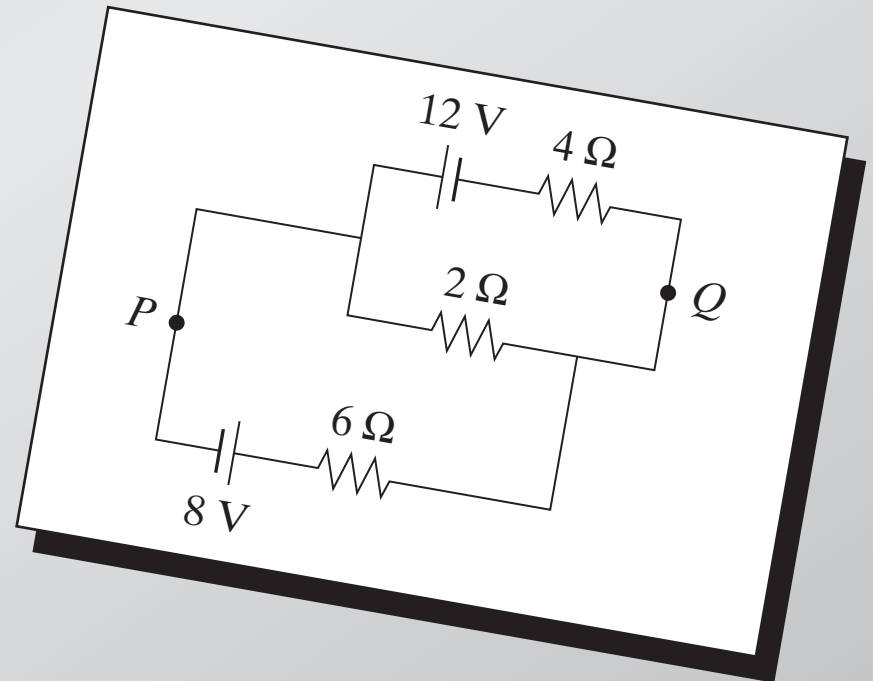

Education

are the basic principles understood?

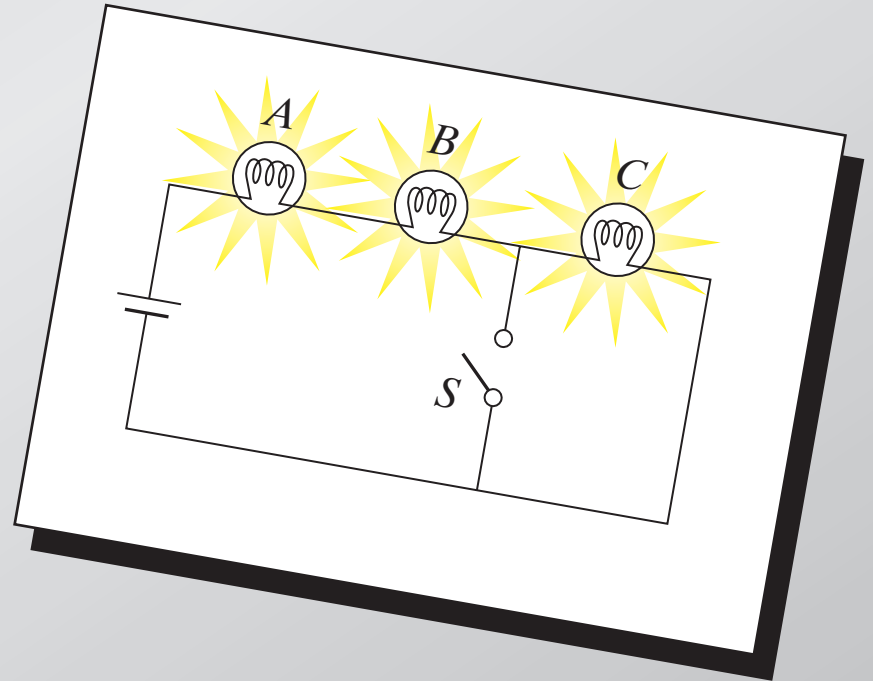

Education

are the basic principles understood?

When S is closed, what happens to:

- (a) intensities of A and B ?
- (b) intensity of C ?
- (c) current through battery?
- (d) potential difference across
 A , B , and C ?
- (e) the total power dissipated?

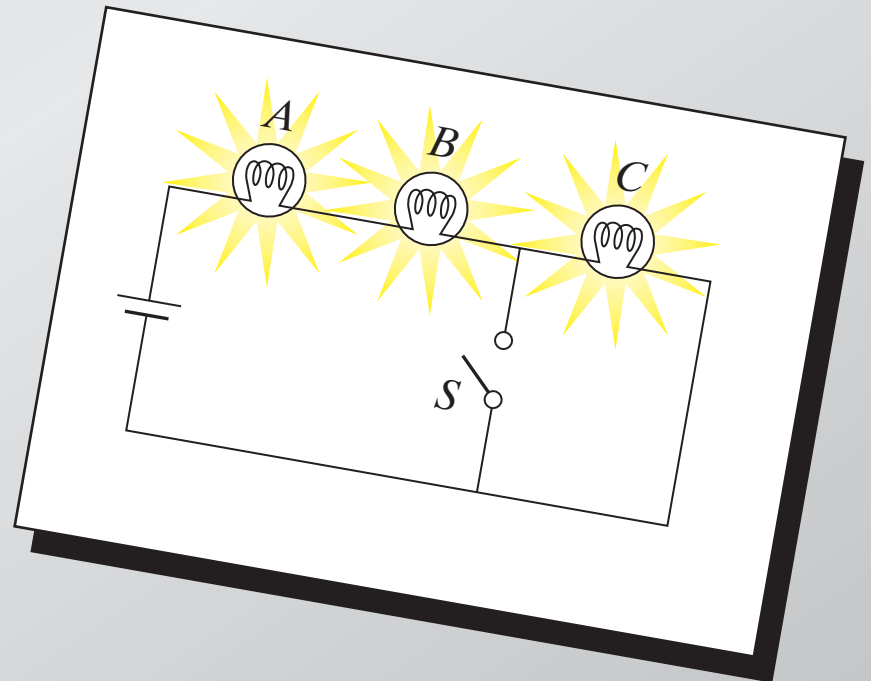

Education

conventional

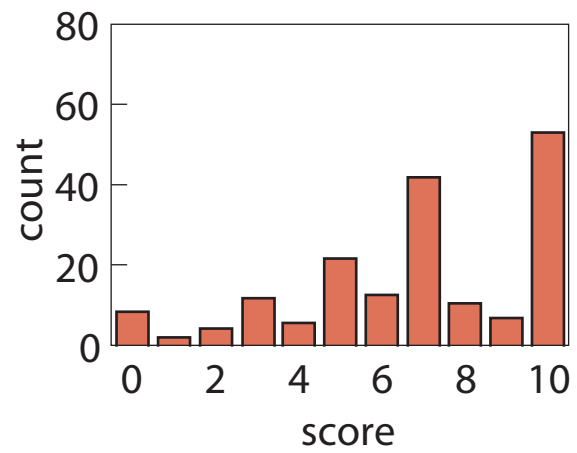

conceptual

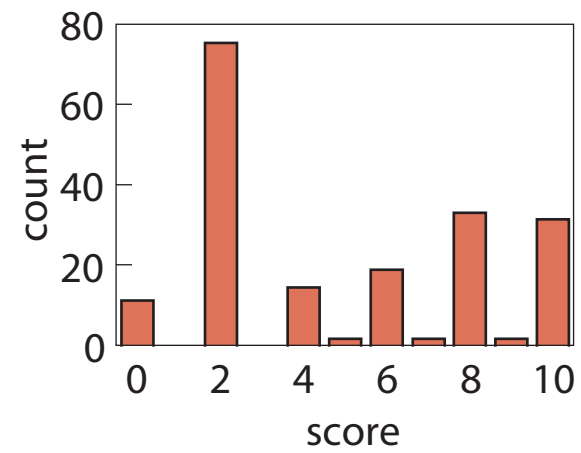

Education

conventional

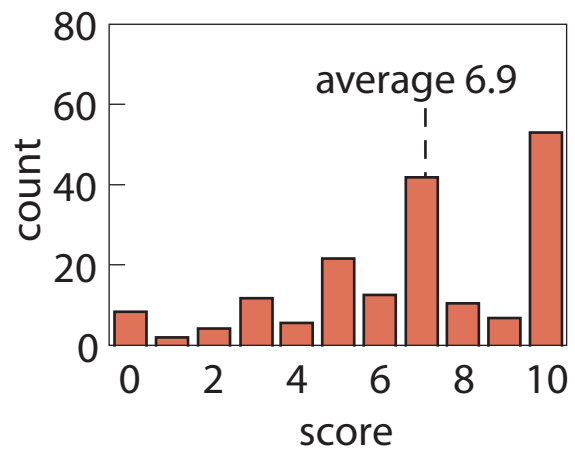

conceptual

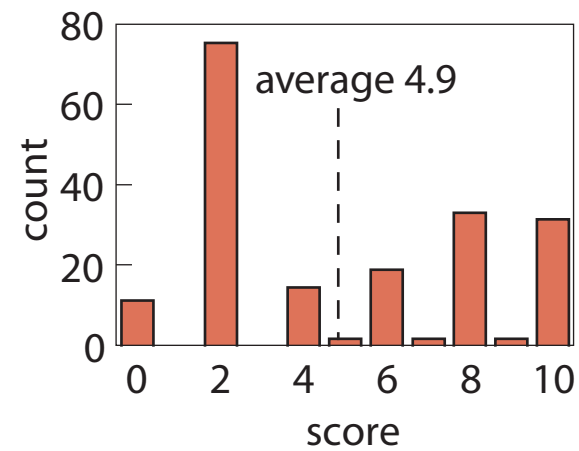

Education

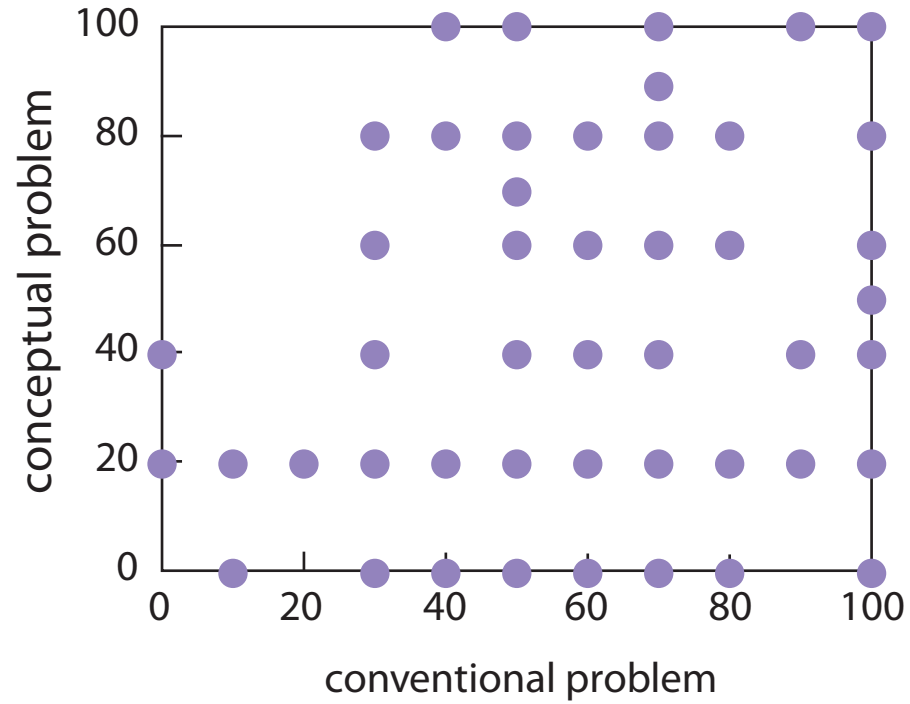

Education

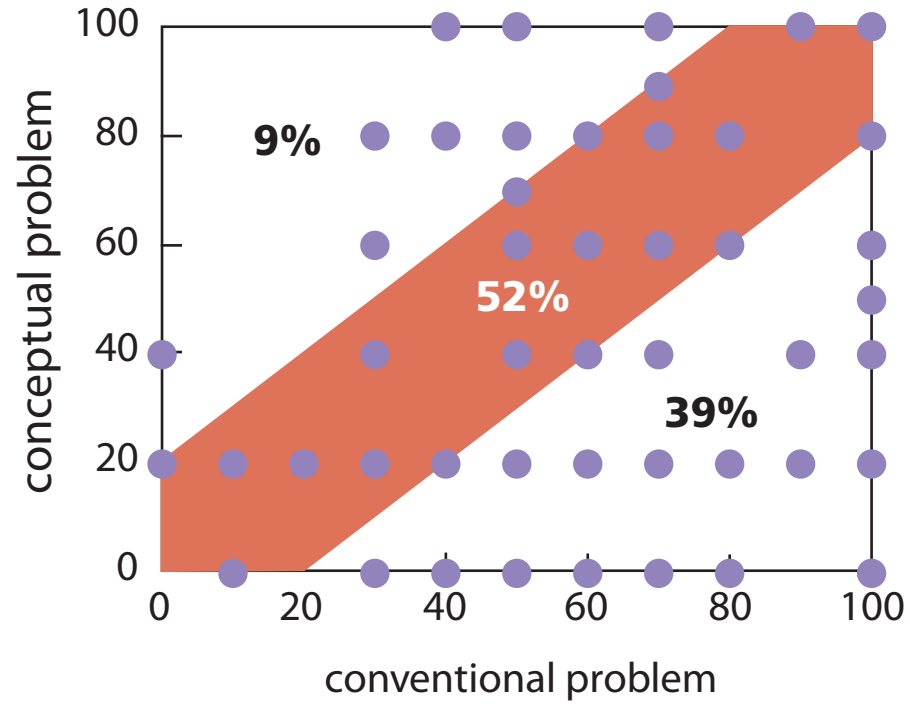

A large lecture hall with a professor at a podium and students seated at desks. A large screen at the front displays text and a diagram. The text on the screen is partially legible and includes the words "The world is full of..." and "The world is full of...". The professor is standing at a podium on the right side of the stage, facing the audience. The students are seated at desks, many with papers open. The room is dimly lit, with the main light source being the screen and the podium area.

So what should we do?

Peer Instruction

Give students more responsibility for gathering information...

Peer Instruction

**Give students more responsibility for gathering information...
so we can better help them assimilate it.**

Peer Instruction

Main features:

- pre-class reading
- in-class: depth, not 'coverage'
- ConcepTests

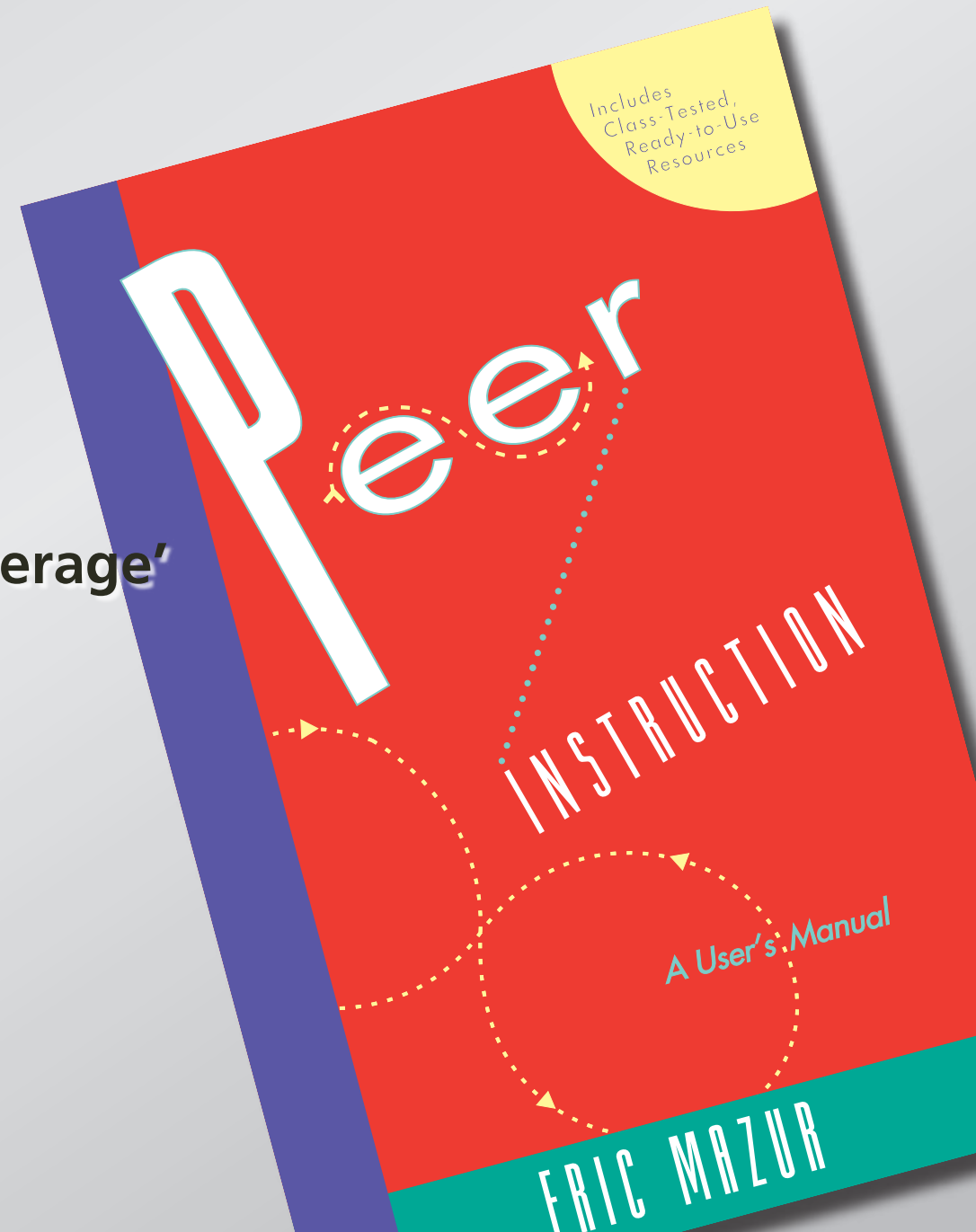

Peer Instruction

ConcepTest:

- 1. Question**
- 2. Thinking**
- 3. Individual answer**
- 4. Peer discussion**
- 5. Revised/Group answer**
- 6. Explanation**

Results

is it any good?

Results

first year of implementing PI

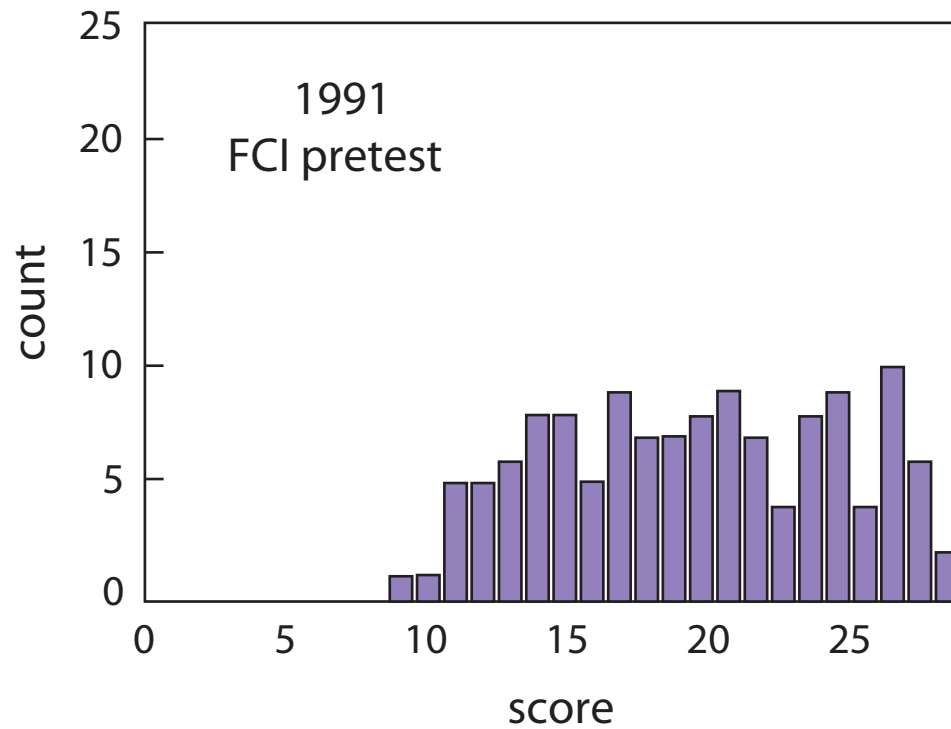

Results

first year of implementing PI

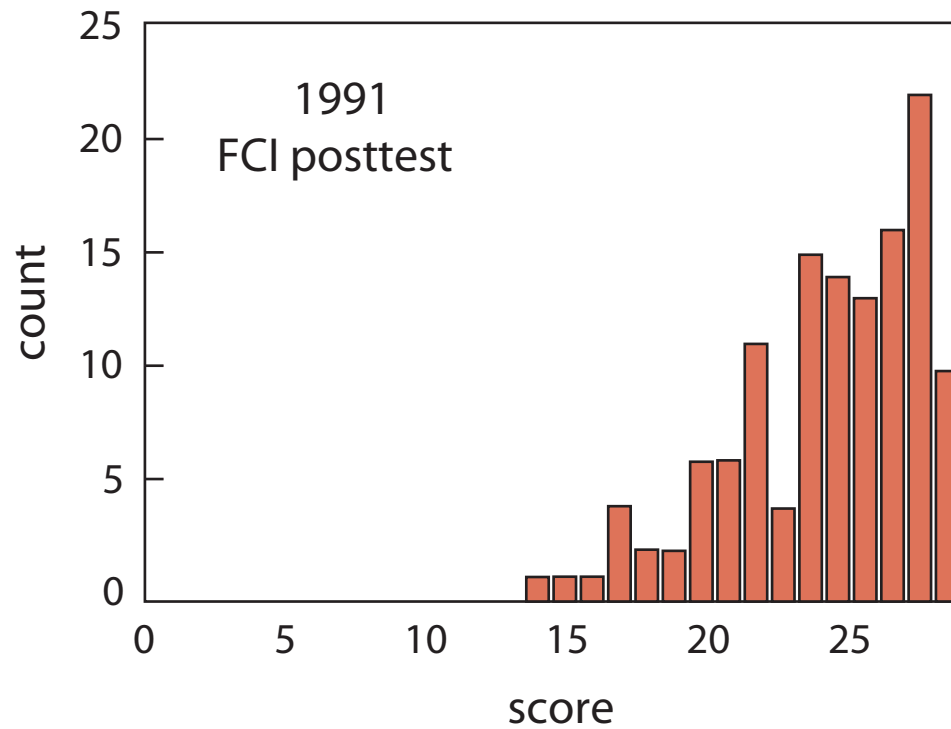

Results

first year of implementing PI

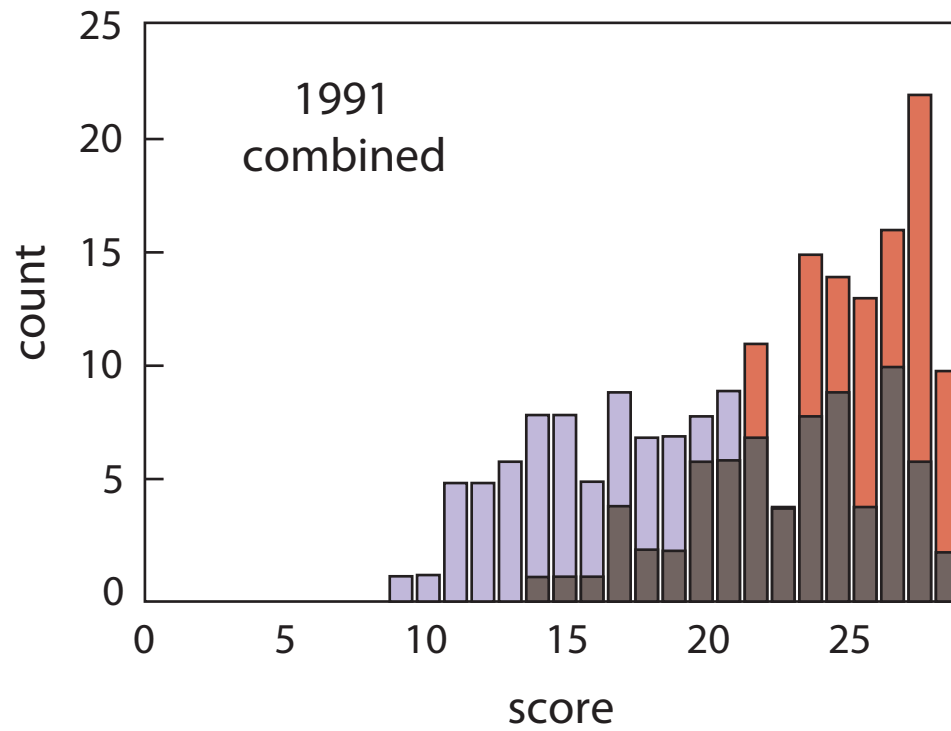

Results

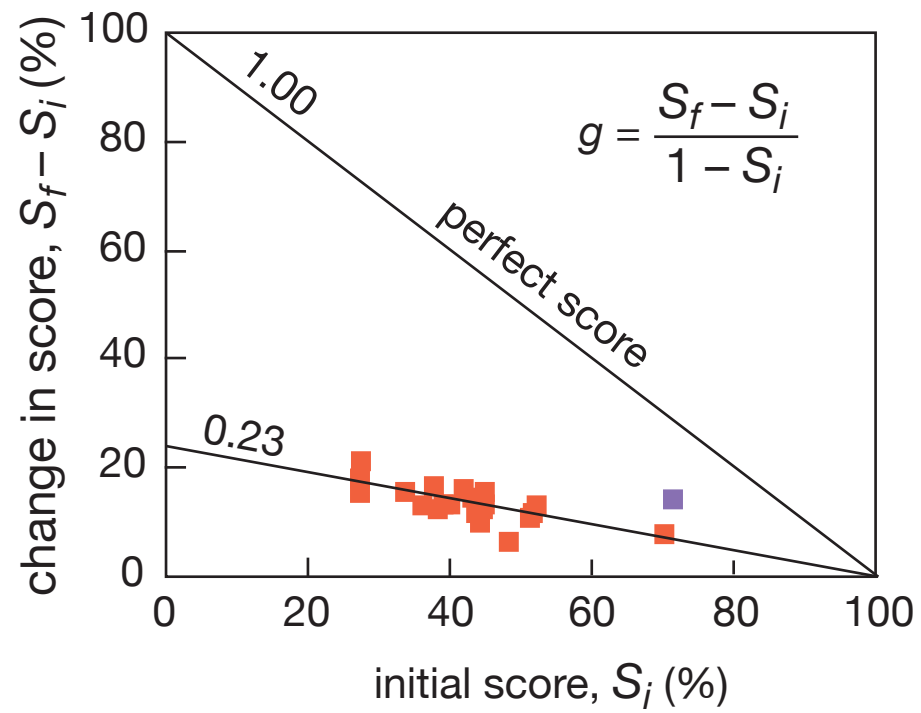

Results

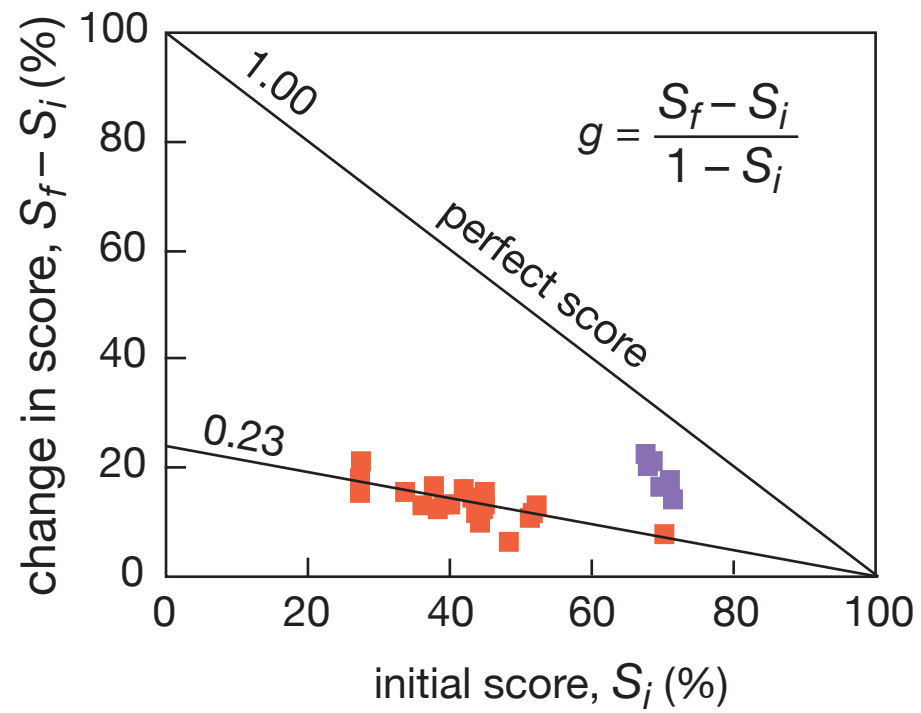

Results

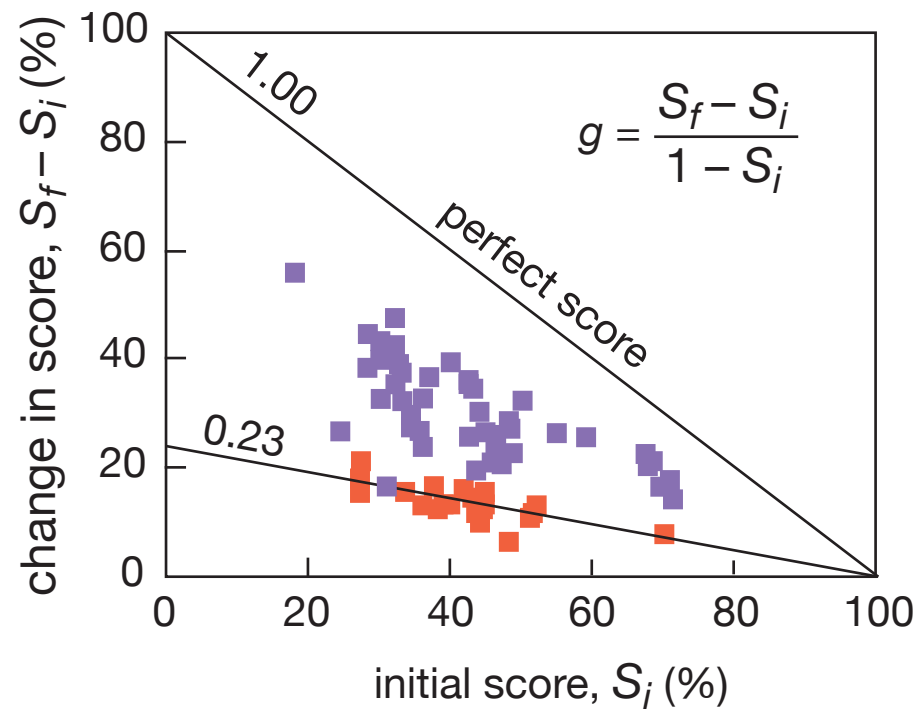

Results

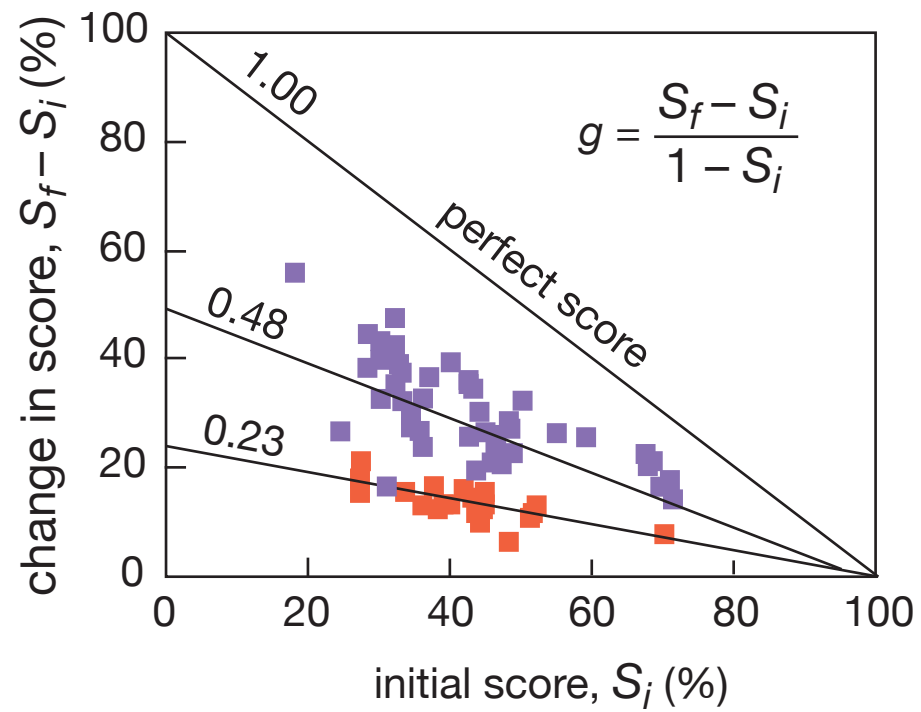

Results

what about problem solving?

Results

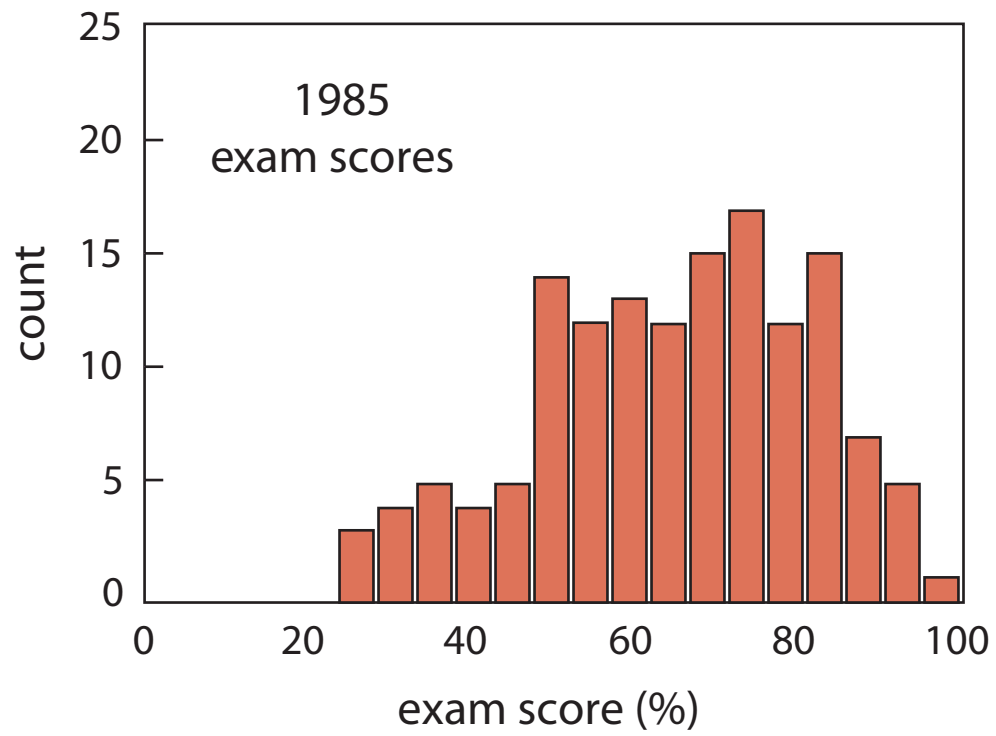

Results

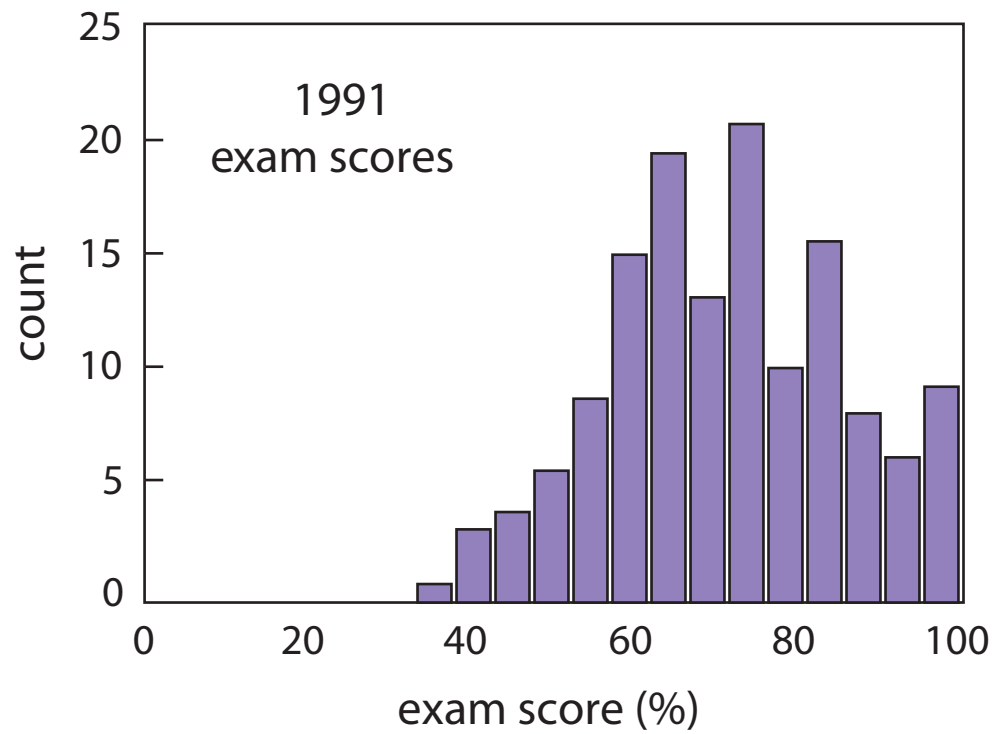

Results

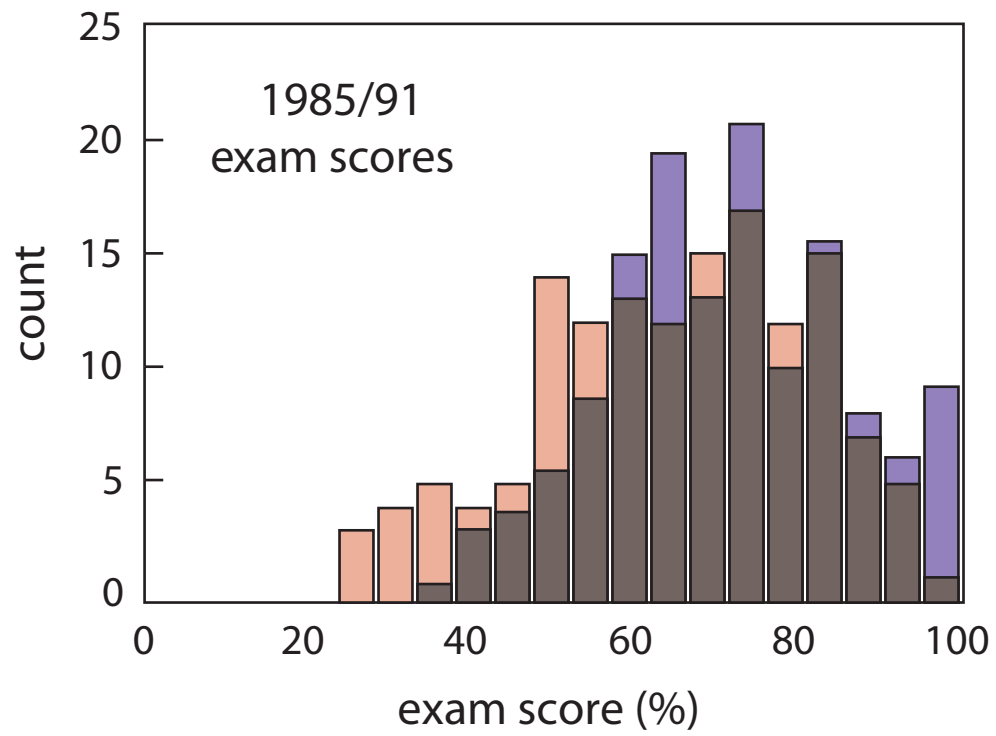

Summary

**So better understanding leads to better
problem solving!**

Summary

So better understanding leads to better problem solving!

(but “good” problem solving doesn’t always indicate understanding!)

Funding:

National Science Foundation

for a copy of this presentation:

<http://mazur-www.harvard.edu>

Google™

Google Search

I'm Feeling Lucky

Google™

mazur

Google Search

I'm Feeling Lucky

Google™

mazur

Google Search

I'm Feeling Lucky

Google™

mazur

Google Search

I'm Feeling Lucky

Funding:

National Science Foundation

for a copy of this presentation:

<http://mazur-www.harvard.edu>