

Memorization or understanding: Are we teaching the right thing?

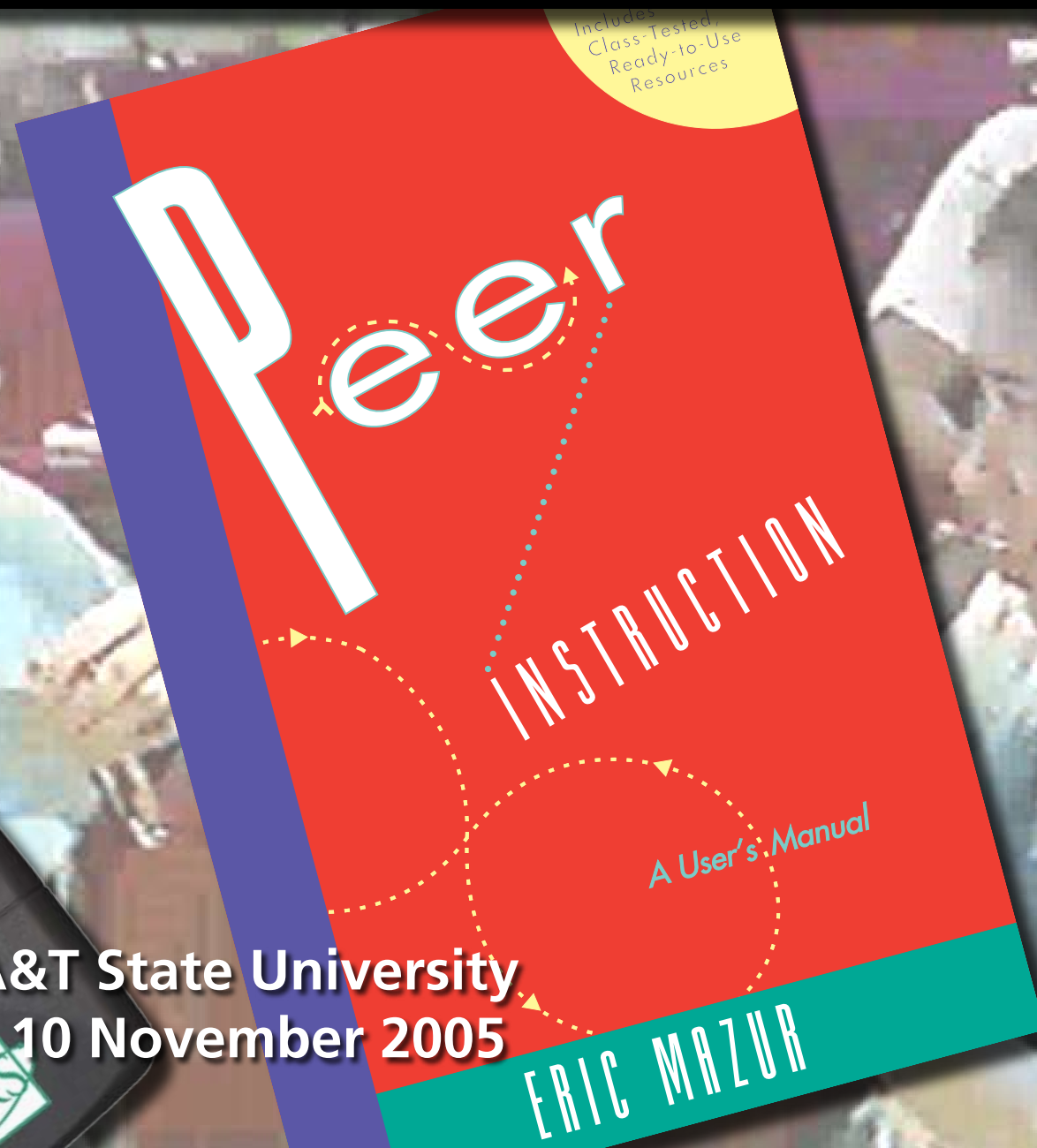

North Carolina A&T State University
Greensboro, NC, 10 November 2005

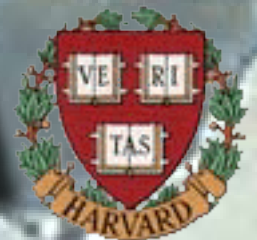

Outline

- Problem



Outline

- Problem

- Cause



Outline

A photograph of a group of people sitting around a table in a meeting. A man in a blue shirt is on the left, gesturing with his hands. A woman in a white headscarf is on the right, also gesturing. In the center, another woman is looking towards the man in blue. The background is slightly blurred, showing other people and a red wall.

- **Problem**

- **Cause**

- **Remedy**

We have a problem

340,000 students take
introductory physics
each year

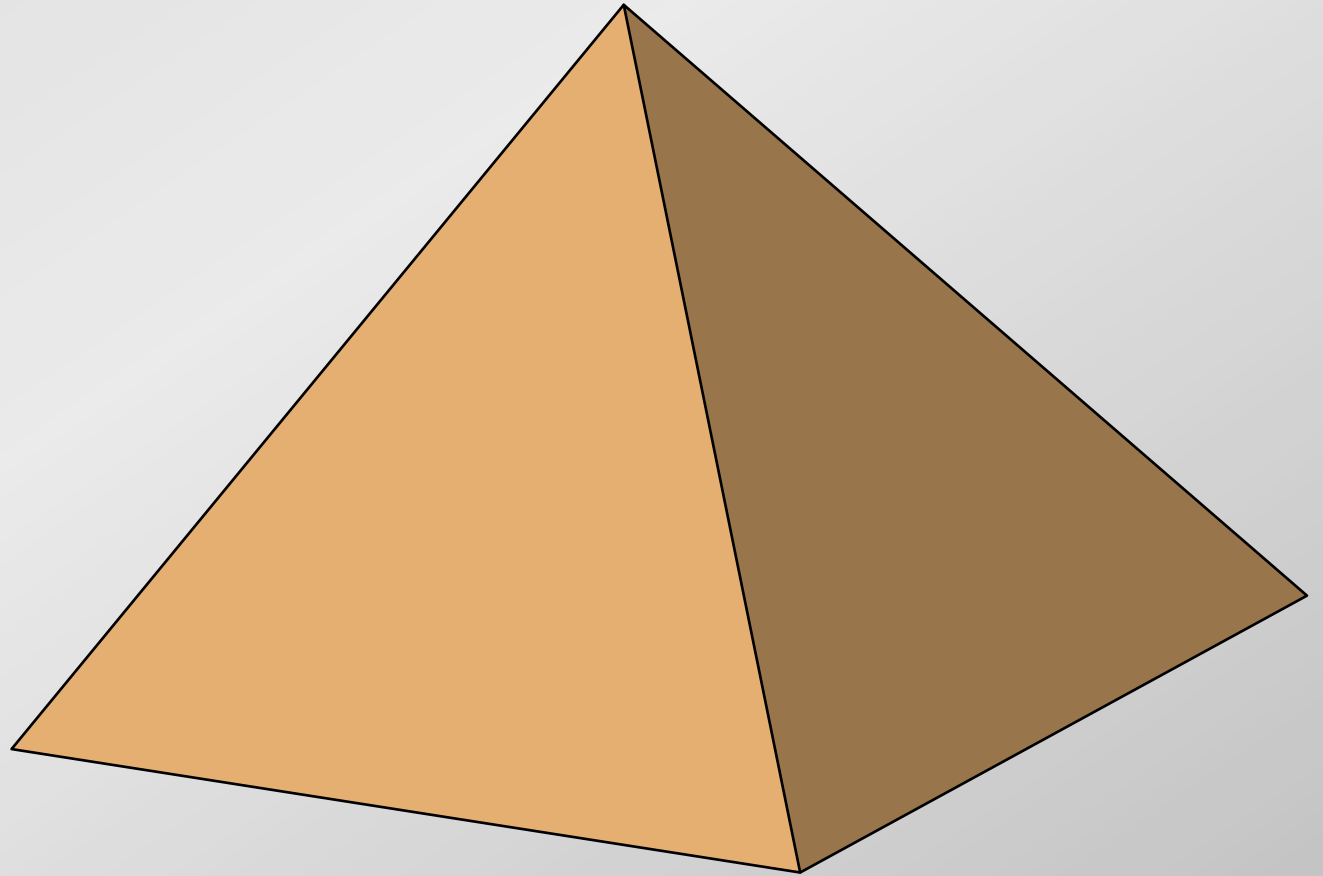

AIP Report R-151.39 (2003)

We have a problem

about 1% of these get
a bachelor's degree
in physics

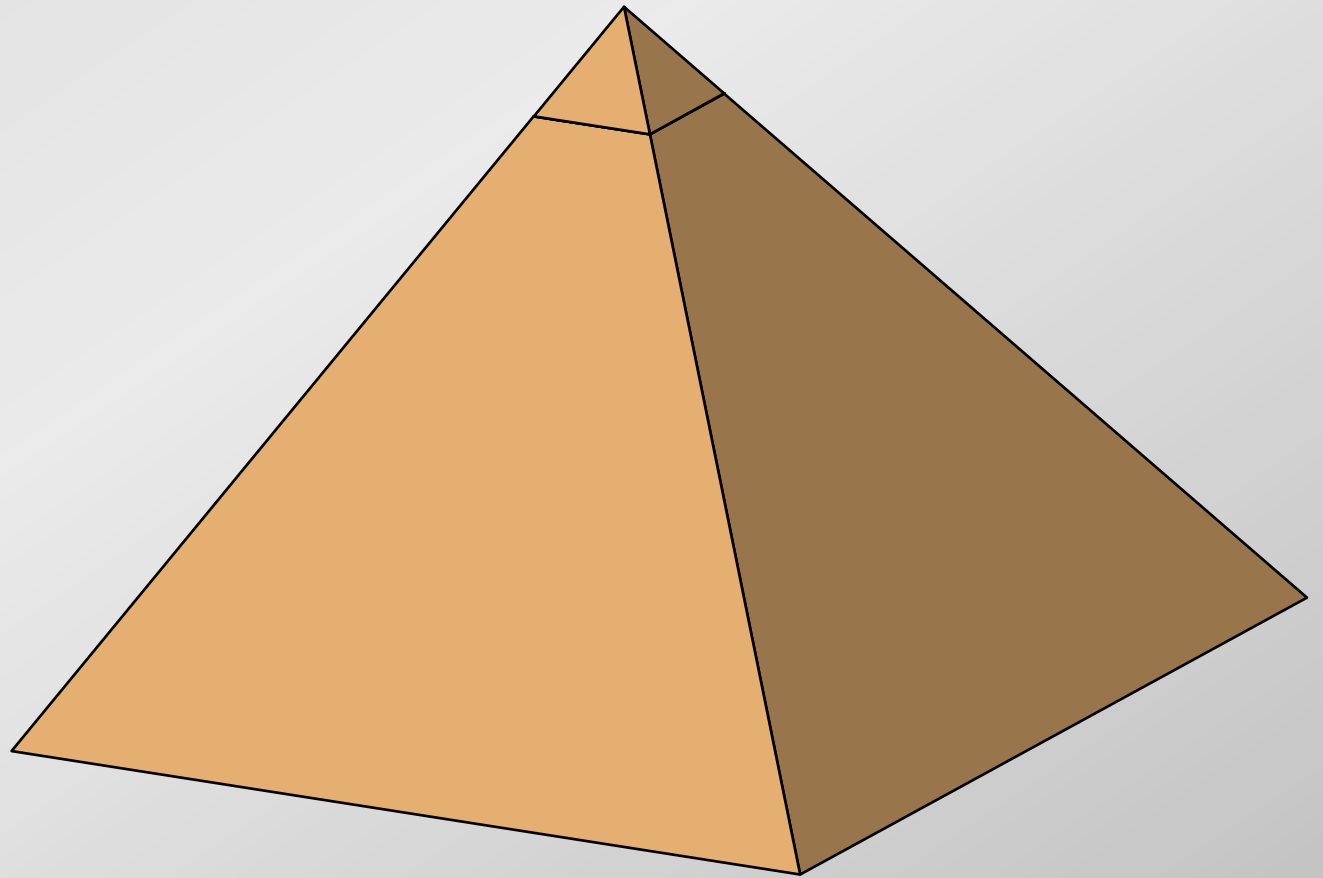

We have a problem

Of the 4,100 students with
a bachelor's degree
in physics...

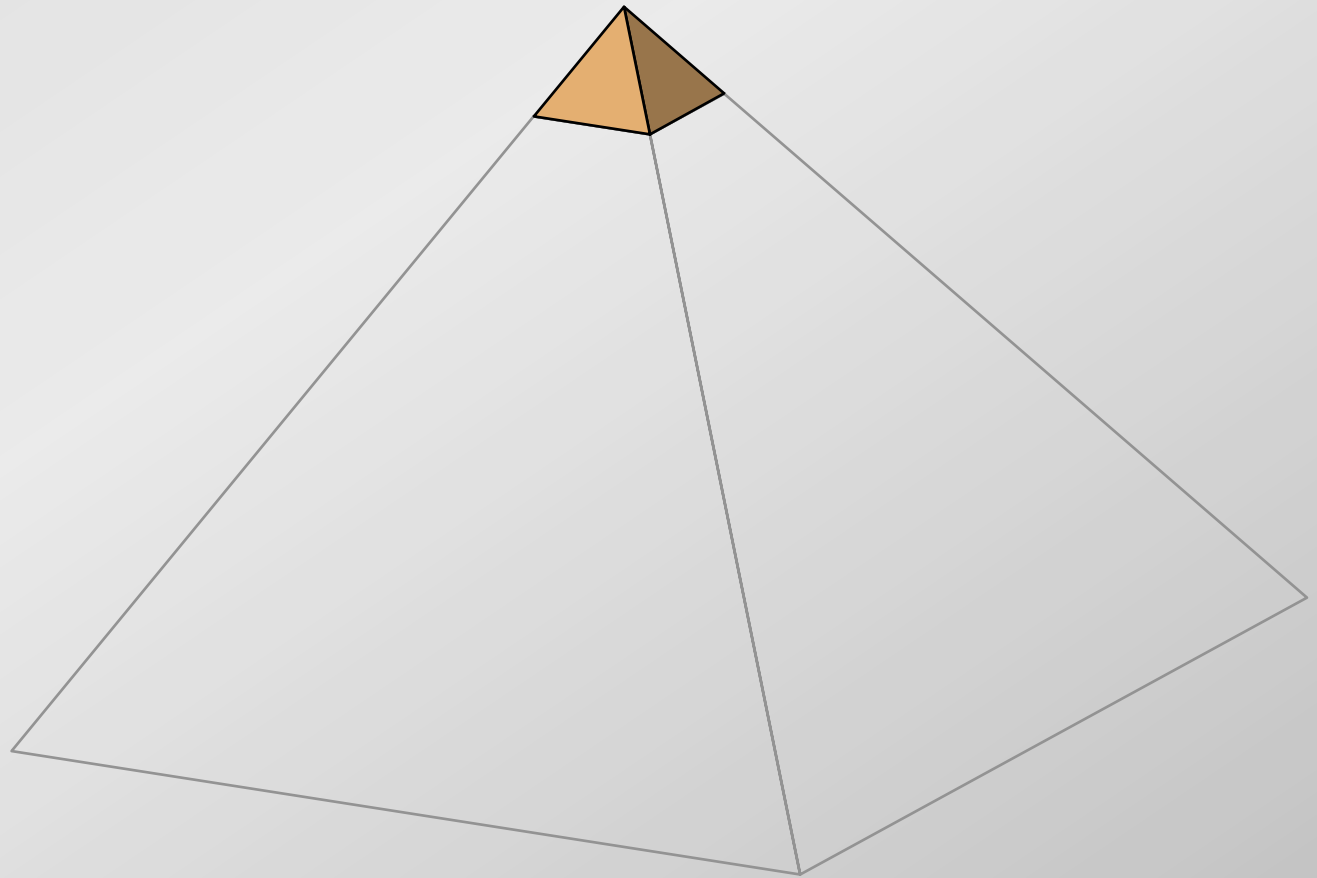

We have a problem

about 28% go on to get a
Ph.D. in physics...

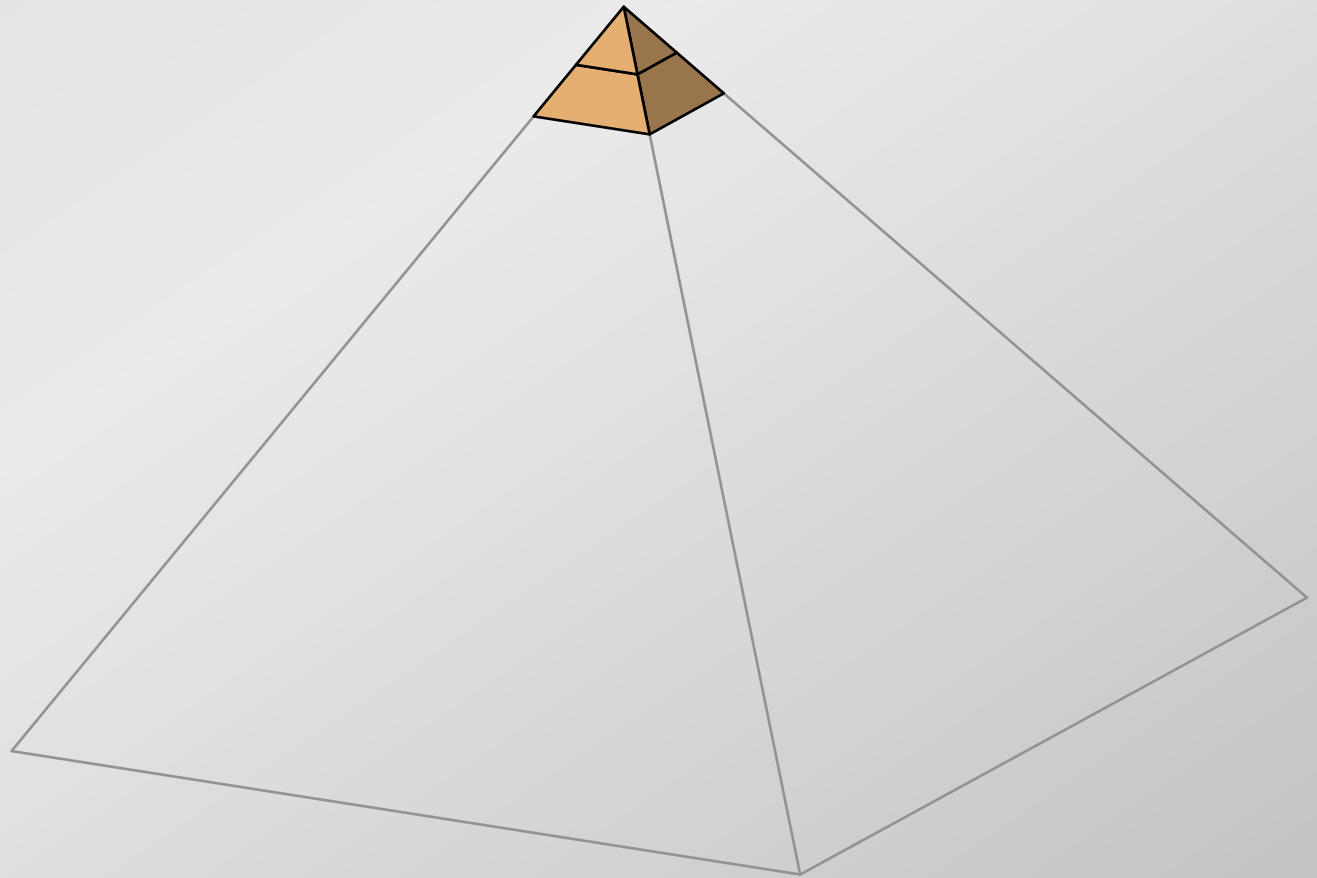

We have a problem

That's one out of every
300 students in our
introductory
courses!

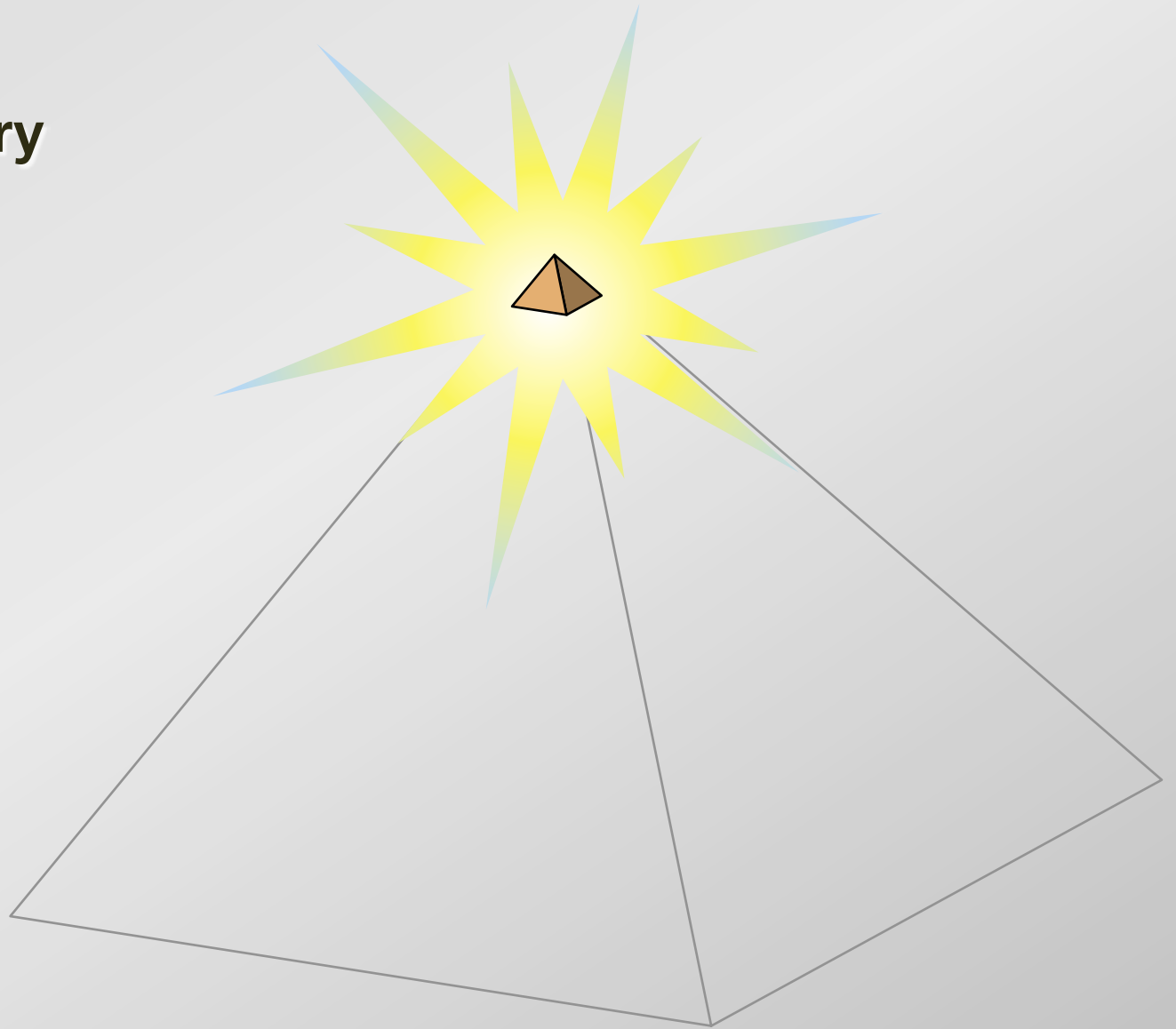

We have a problem

What about the
other 299...?

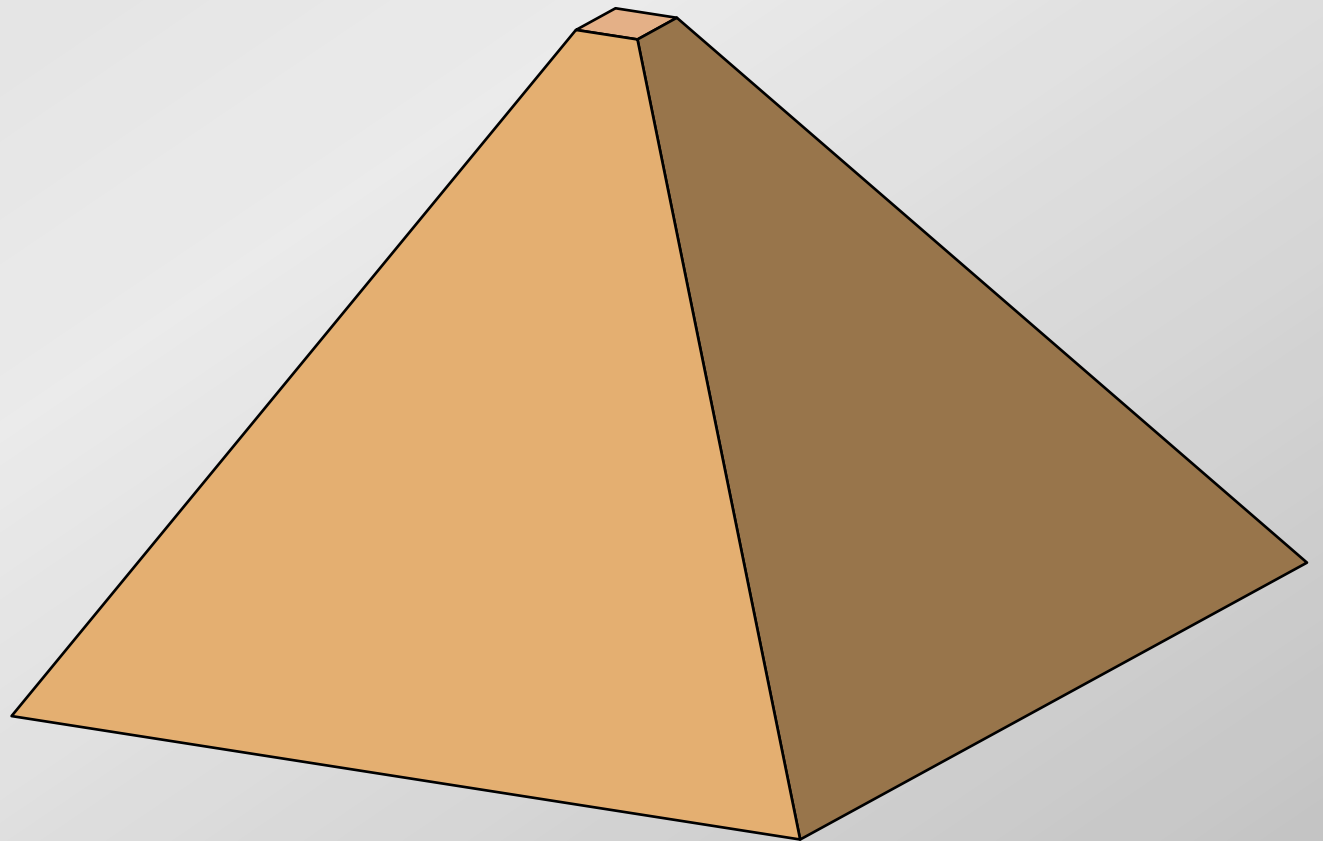

We have a problem

What do we know
about these
students?

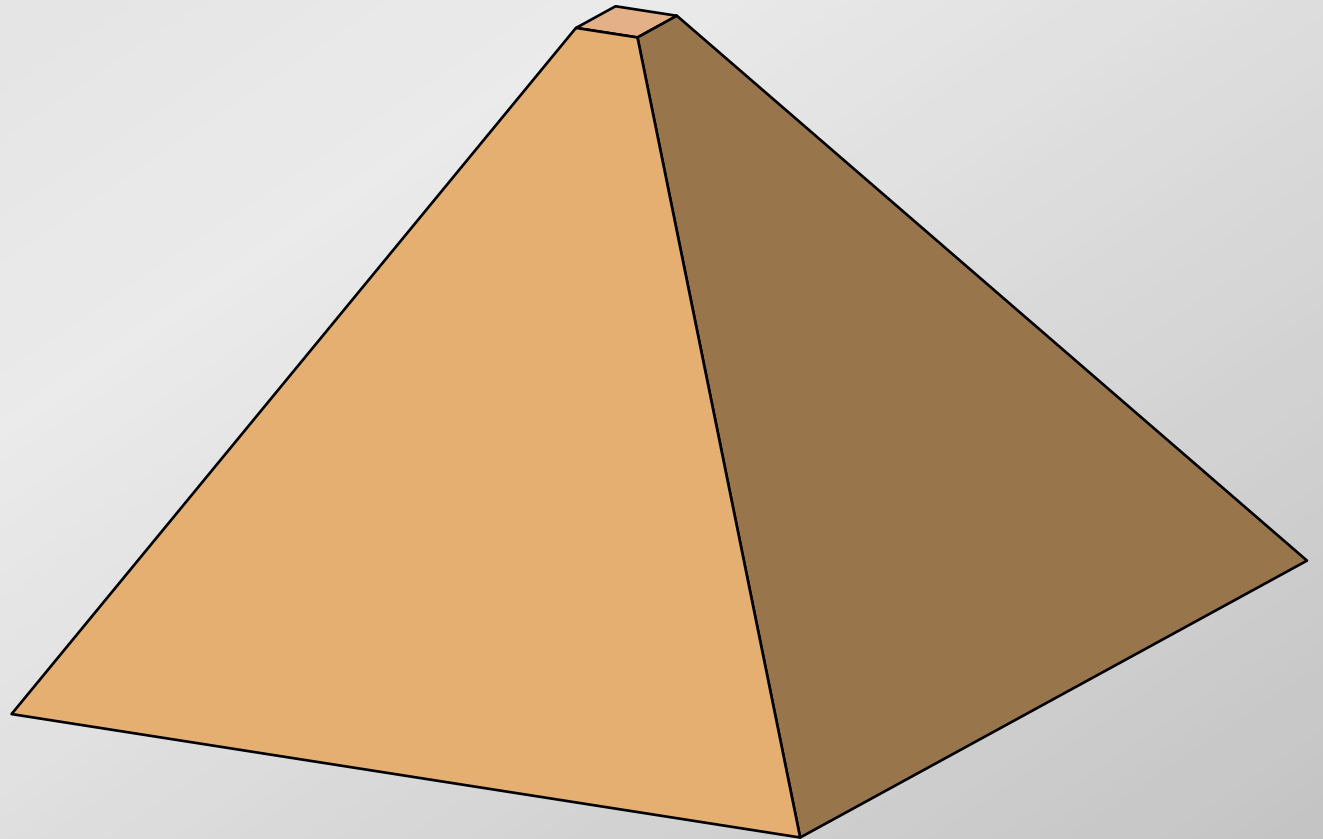

We have a problem

Some disturbing symptoms:

- **frustration**
- **lack of understanding**
- **lack of basic knowledge**

We have a problem

They know the jargon:

- circular motion
- barometric pressure
- light radius
- something to the power times ten to the something

We have a problem

They are aware of their lack of knowledge:

- I graduated from college, but I didn't study *astronomy*
- It's been a while since I've had physics

We have a problem

They are aware of their lack of knowledge:

- I graduated from college, but I didn't study *astronomy*
- It's been a while since I've had physics

...and they don't care!

We have a problem

Should we worry?

We have a problem

We'd better!

We have a problem

"I took four years of science
and four years of math...

A waste of my time,
a waste of the teacher's time,
and a waste of space...

You know, I took *physics*.

For *what?*"





Why do we have this problem?

Why do we have this problem?



Why do we have this problem?

lectures focus on delivery of information

A photograph of a large lecture hall. A lecturer is standing at a podium on a stage, addressing a large audience seated in rows of desks. The room has a curved wall and a large screen at the front. The text "lectures focus on delivery of information" is overlaid on the image.

Why do we have this problem?

education is not just information transfer

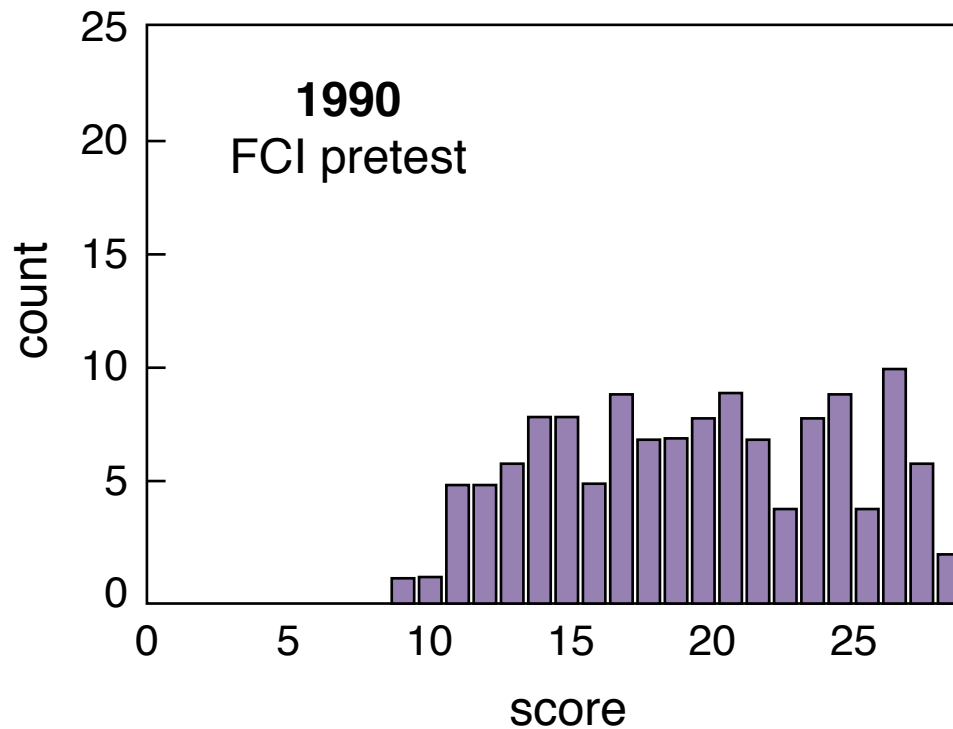

Why do we have this problem?

education is not just information transfer

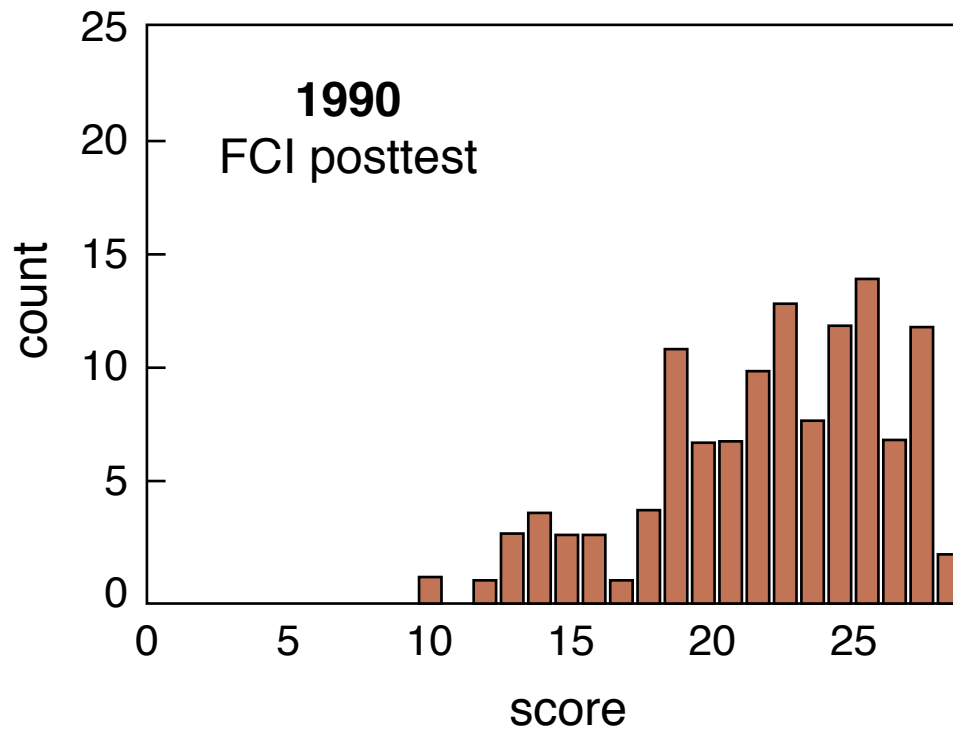

Why do we have this problem?

education is not just information transfer

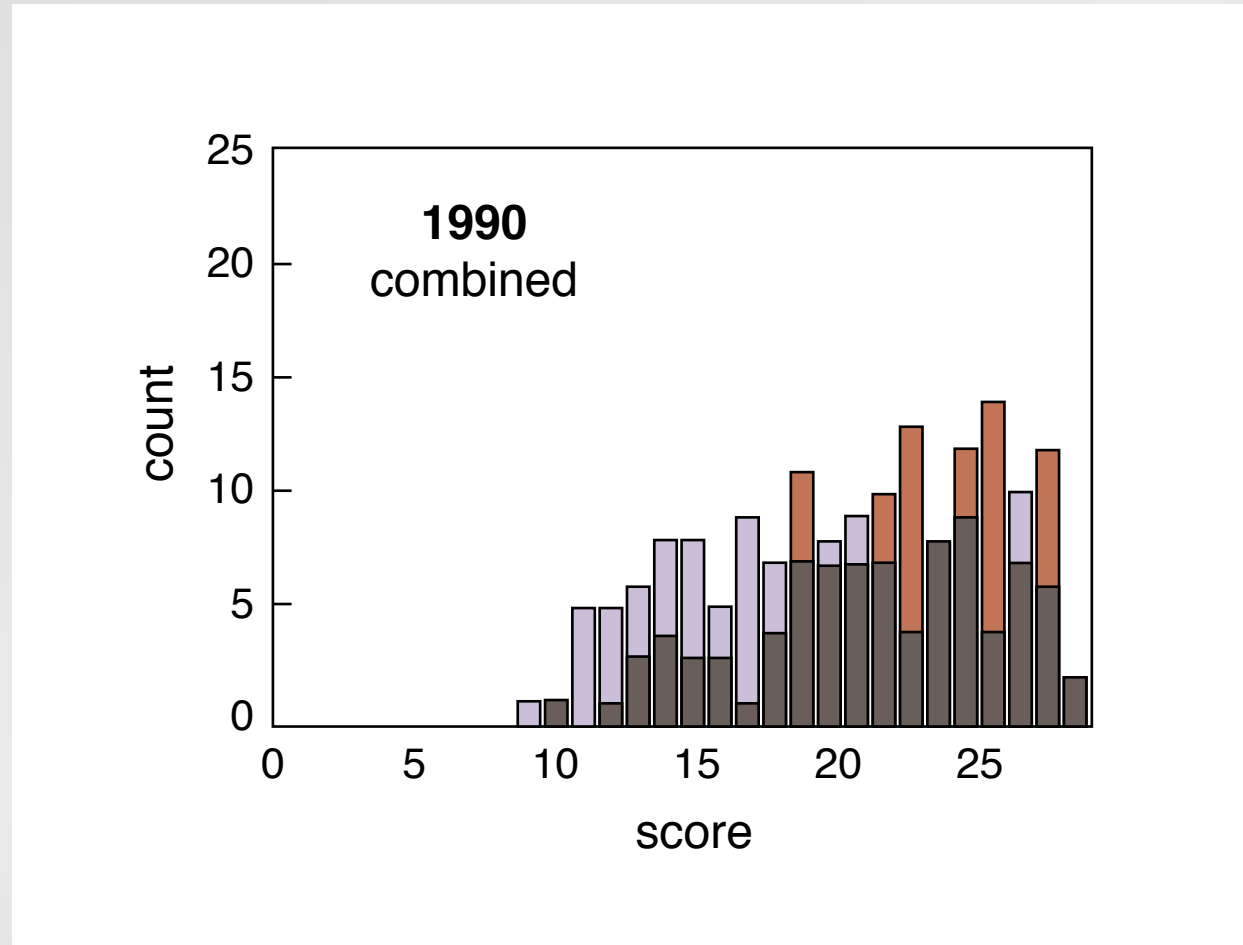

Why do we have this problem?

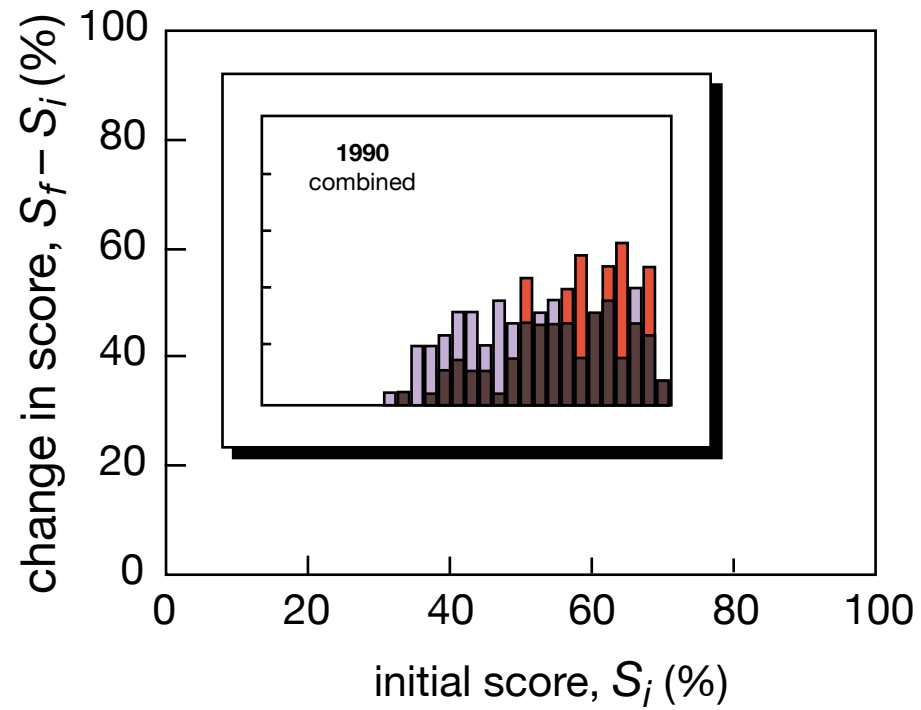

Why do we have this problem?

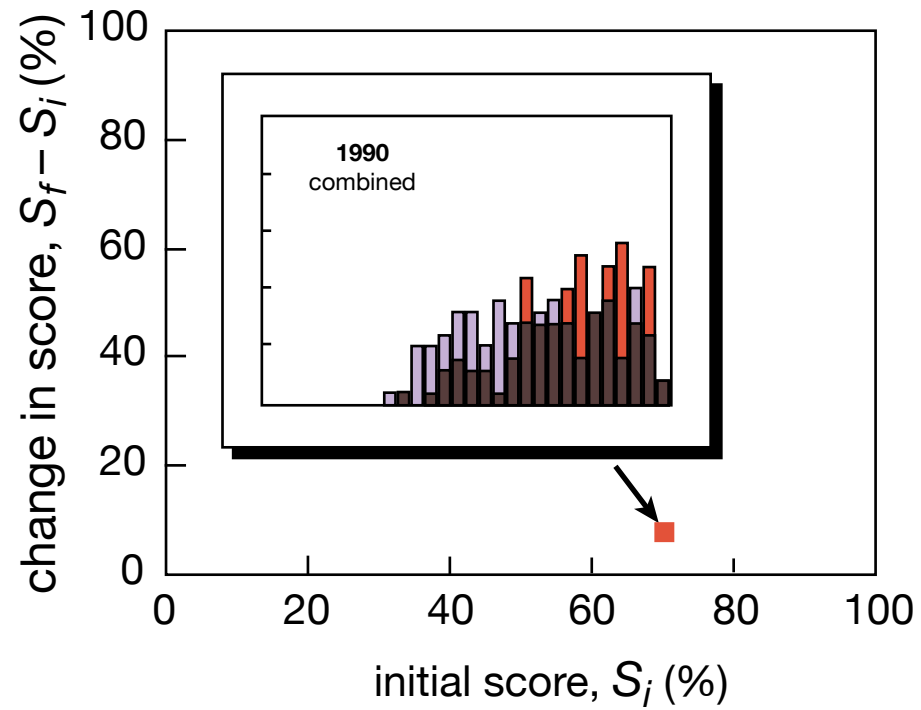

Why do we have this problem?

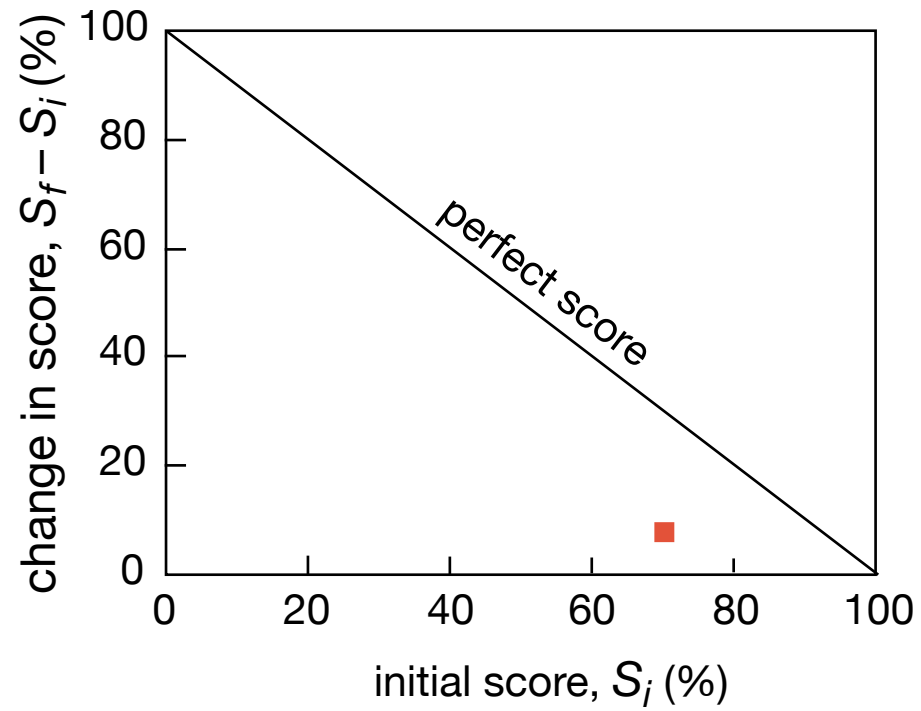

Why do we have this problem?

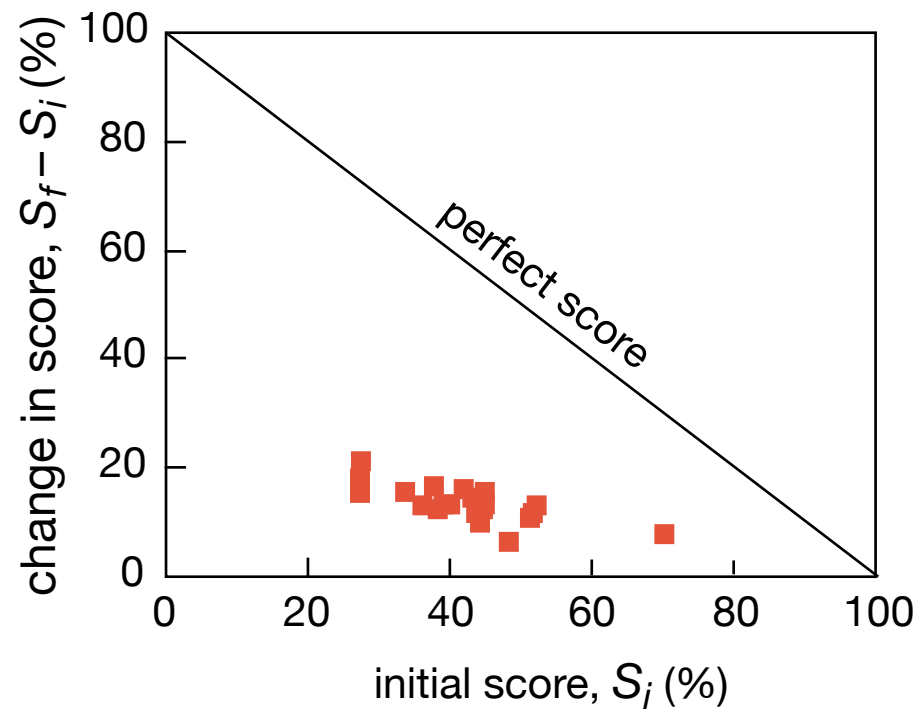

Why do we have this problem?

only one quarter of maximum gain realized

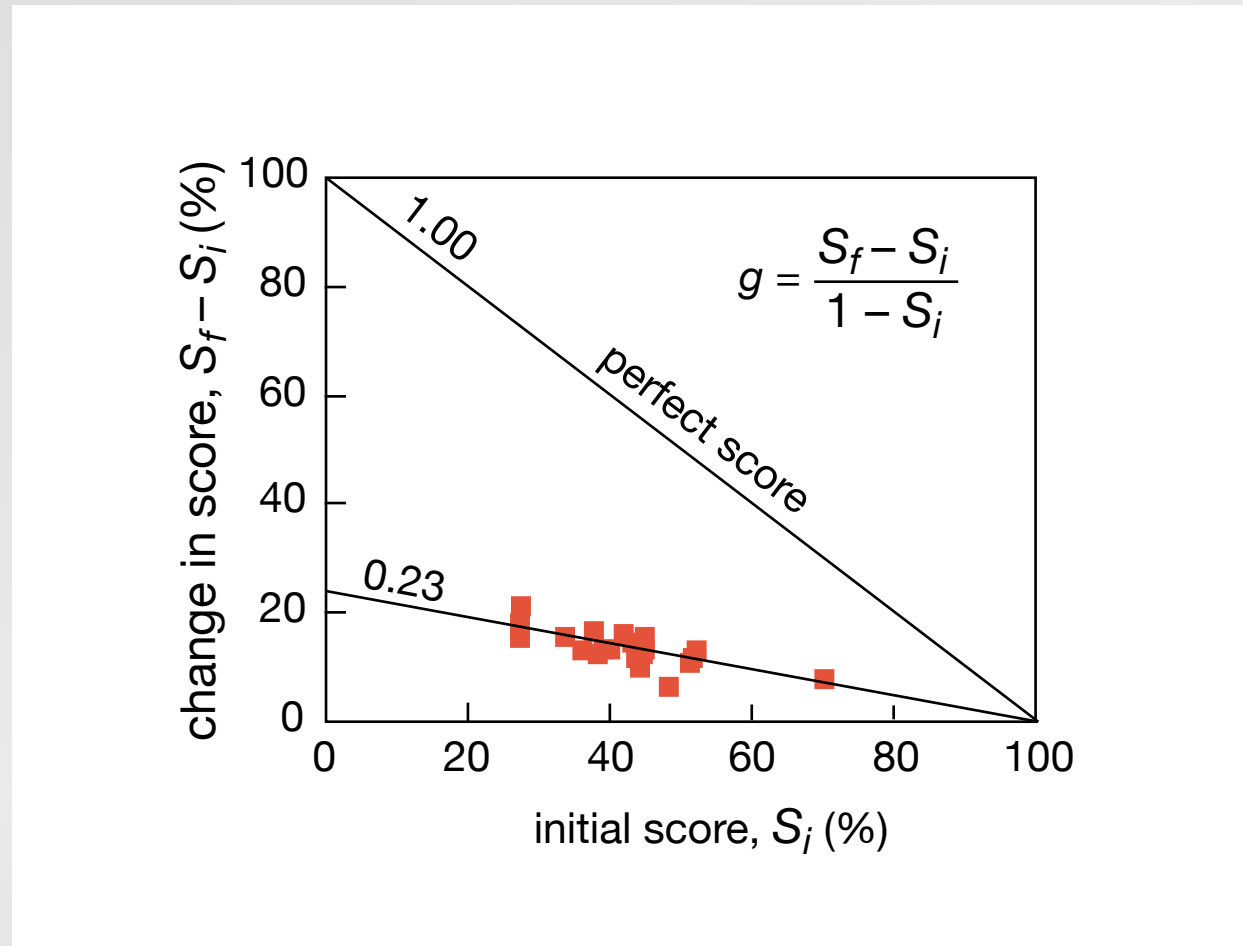

Why do we have this problem?

not transfer but assimilation of information is key

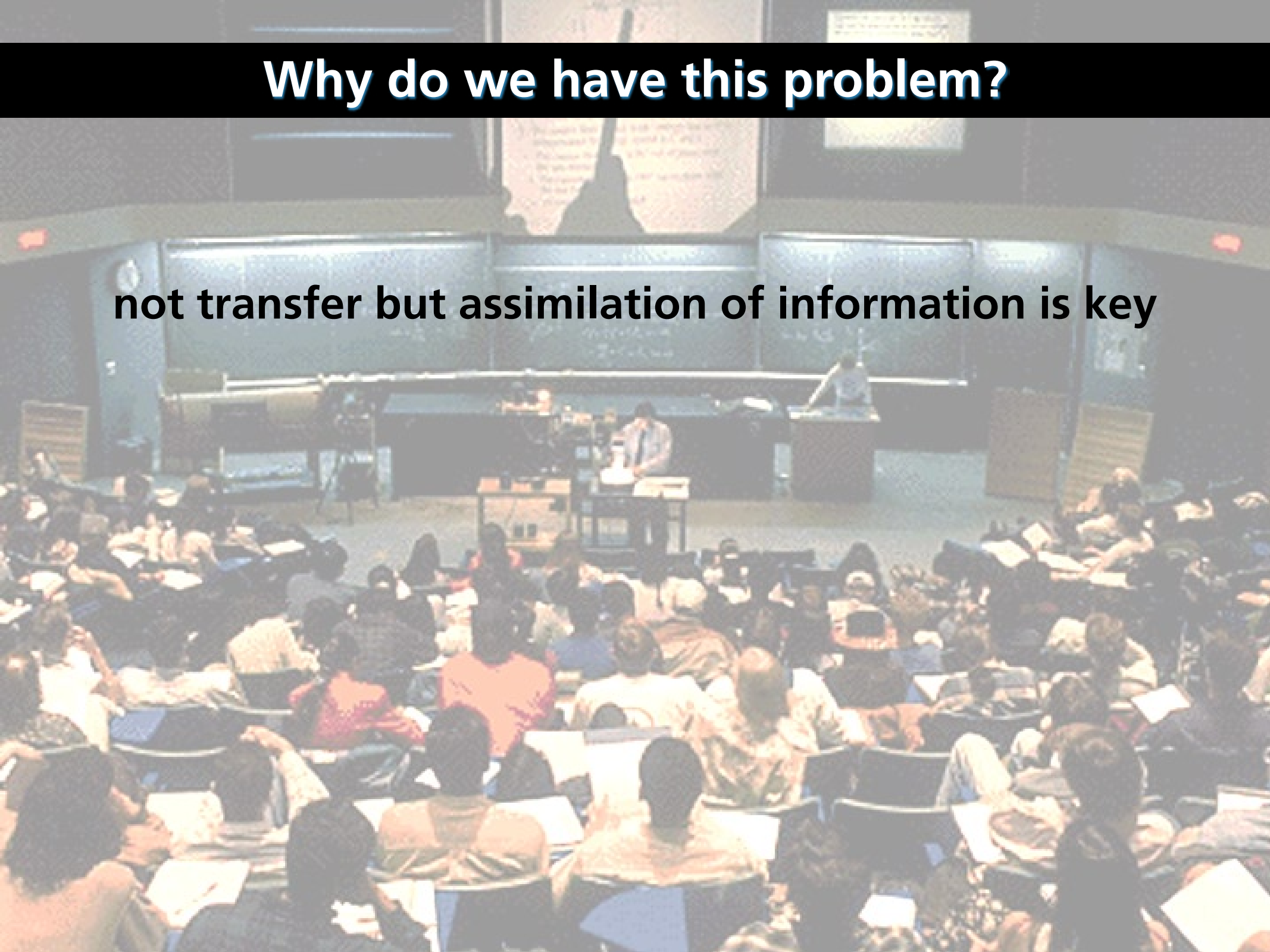

Why do we have this problem?

conventional problems reinforce bad study habits

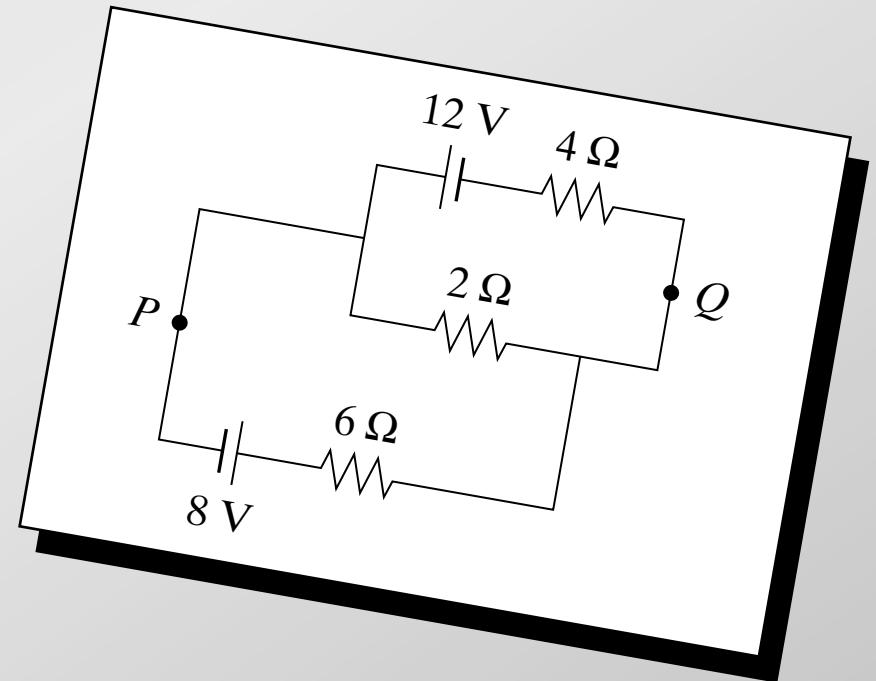

Why do we have this problem?

conventional problems reinforce bad study habits

Calculate:

(a) current in $2\text{-}\Omega$ resistor

(b) potential difference

between P and Q

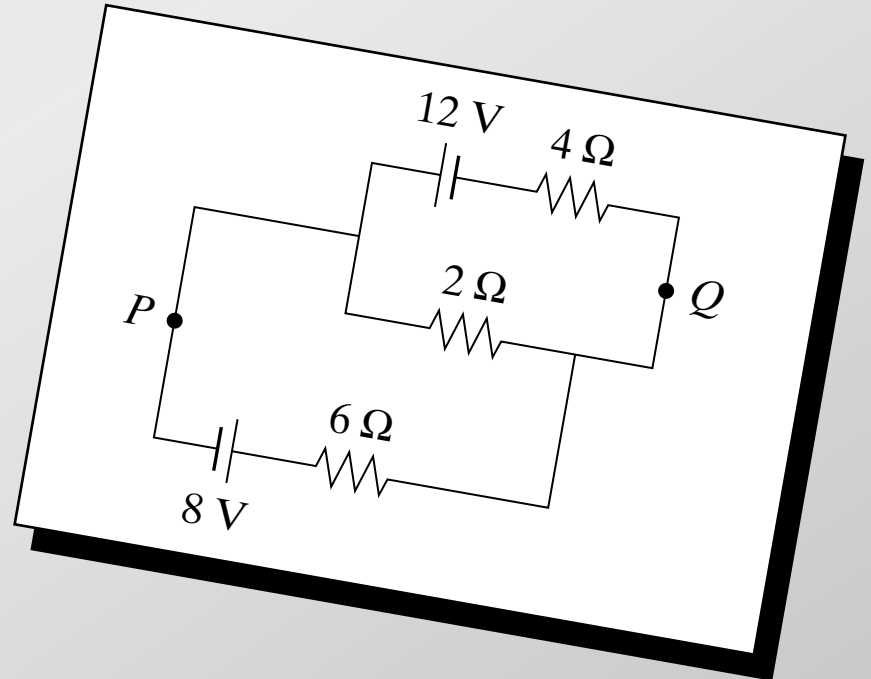

Why do we have this problem?

are the basic principles understood?

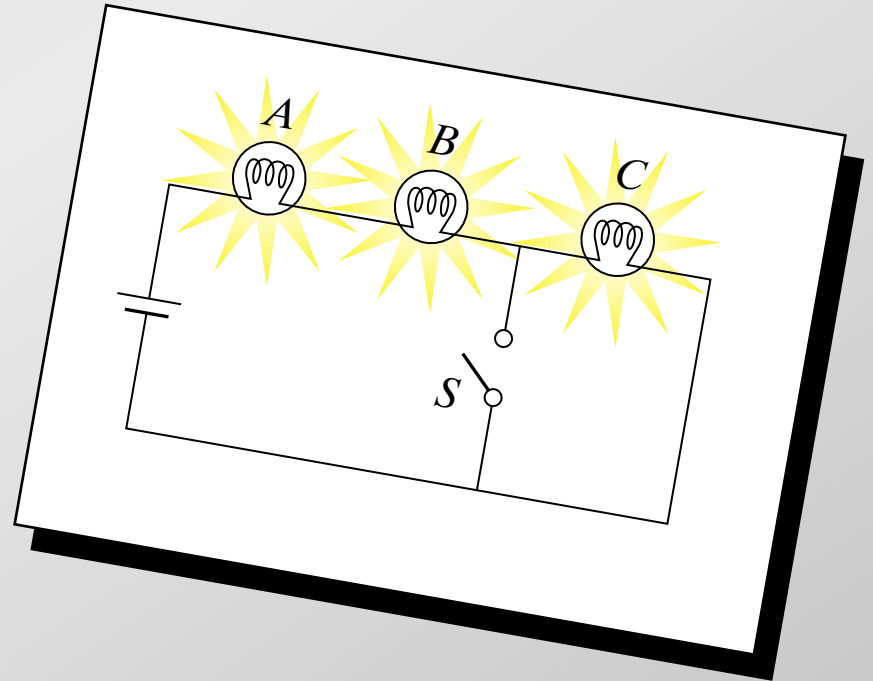

Why do we have this problem?

are the basic principles understood?

When S is closed, what happens to:

- (a) intensities of A and B ?
- (b) intensity of C ?
- (c) current through battery?
- (d) potential difference across
 A , B , and C ?
- (e) the total power dissipated?

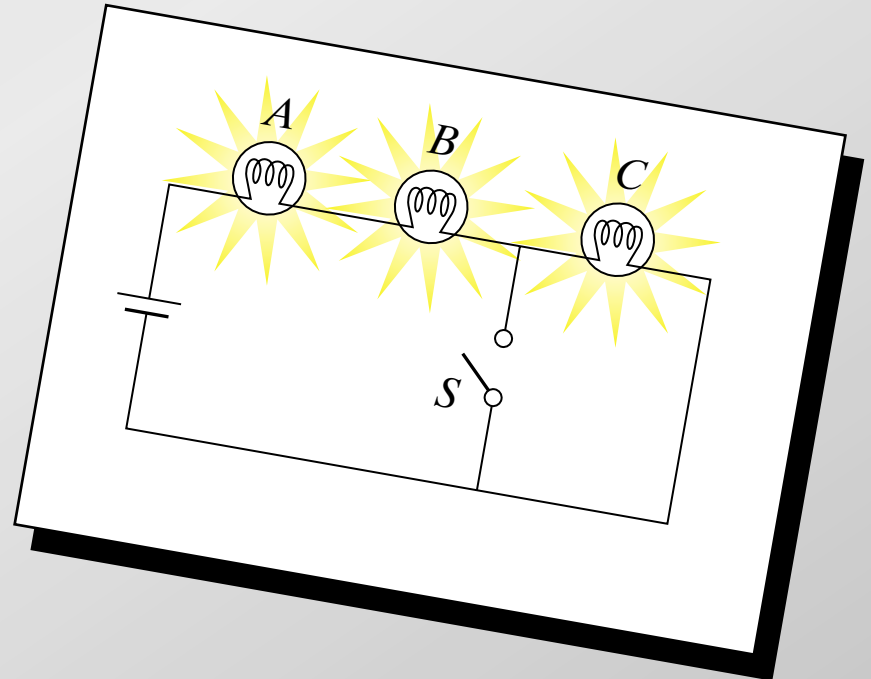

Why do we have this problem?

conventional

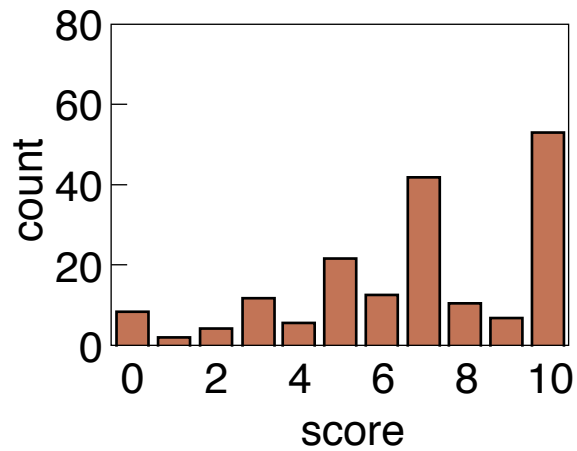

conceptual

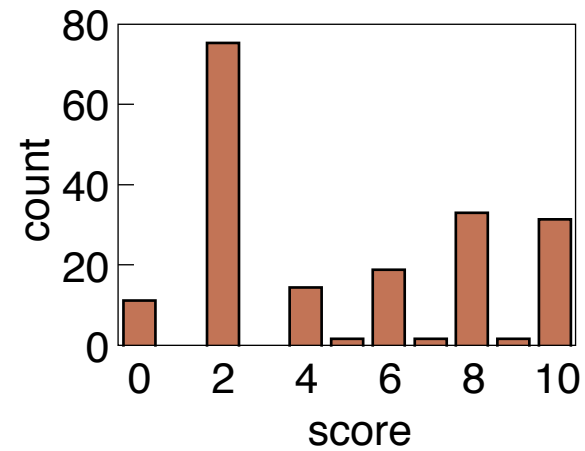

Why do we have this problem?

conventional

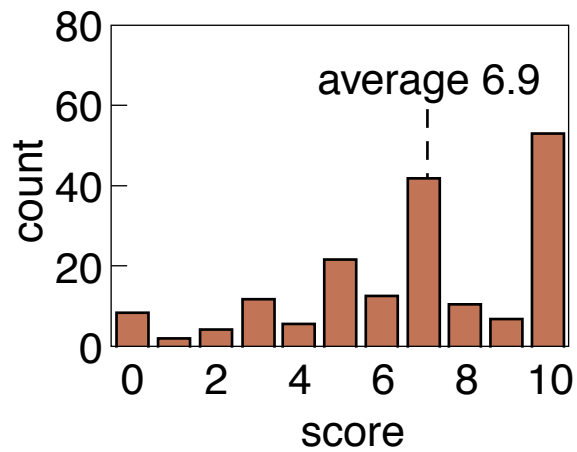

conceptual

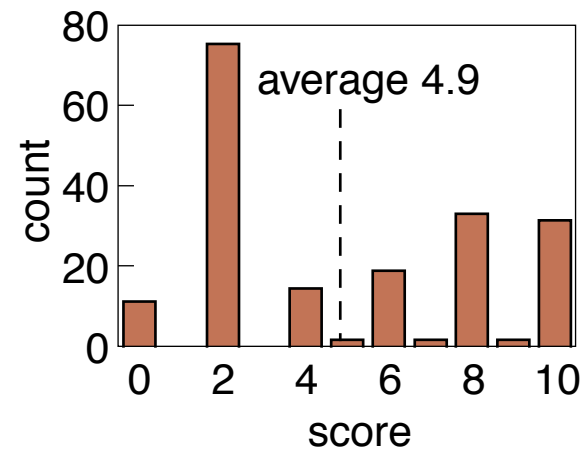

Why do we have this problem?

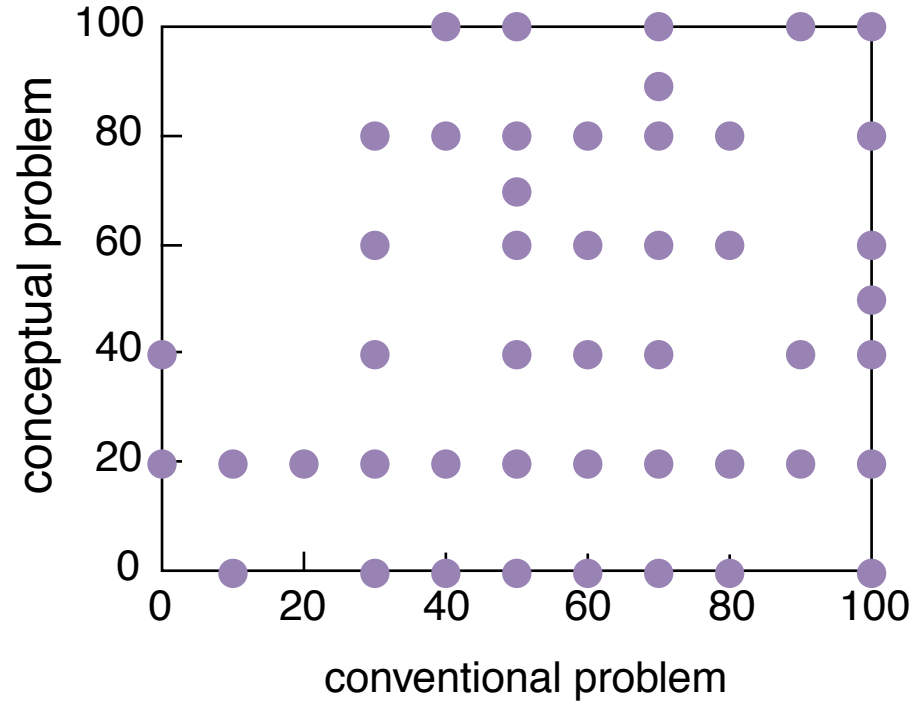

Why do we have this problem?

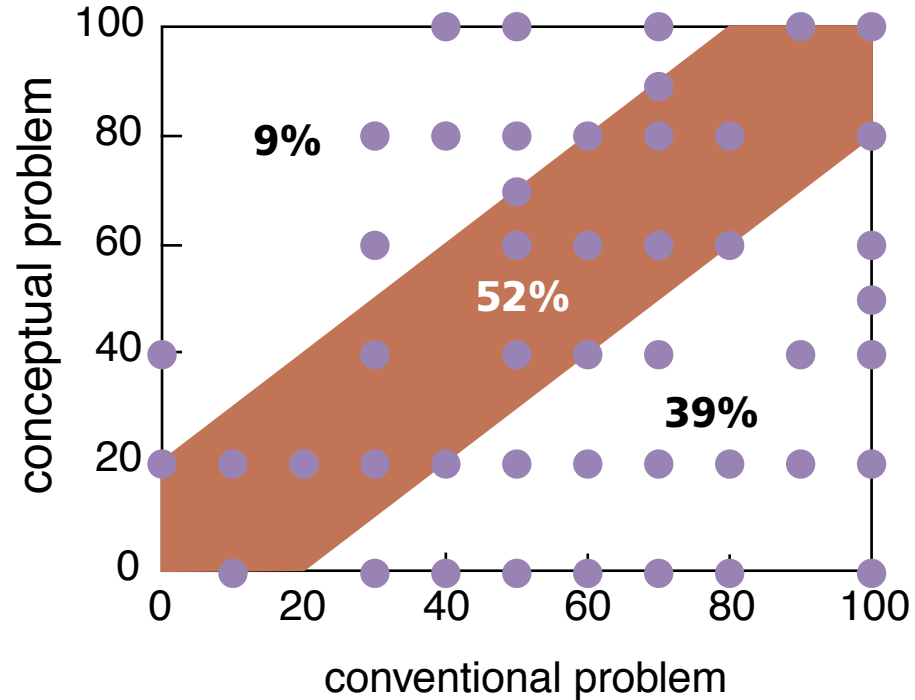

A large lecture hall with a stage and a large screen displaying text. The audience is seated in rows of desks, facing the stage. The stage features a large screen with text, a chalkboard, and a podium. A person is standing at the podium, addressing the audience. The text on the screen is partially legible and appears to be a list of items or a document. The overall atmosphere is that of a formal academic or professional presentation.

So what should we do?

Peer Instruction

Give students more responsibility for gathering information...

Peer Instruction

**Give students more responsibility for gathering information...
so we can better help them assimilate it.**

Peer Instruction

Main features:

- pre-class reading
- in-class: depth, not 'coverage'
- ConcepTests

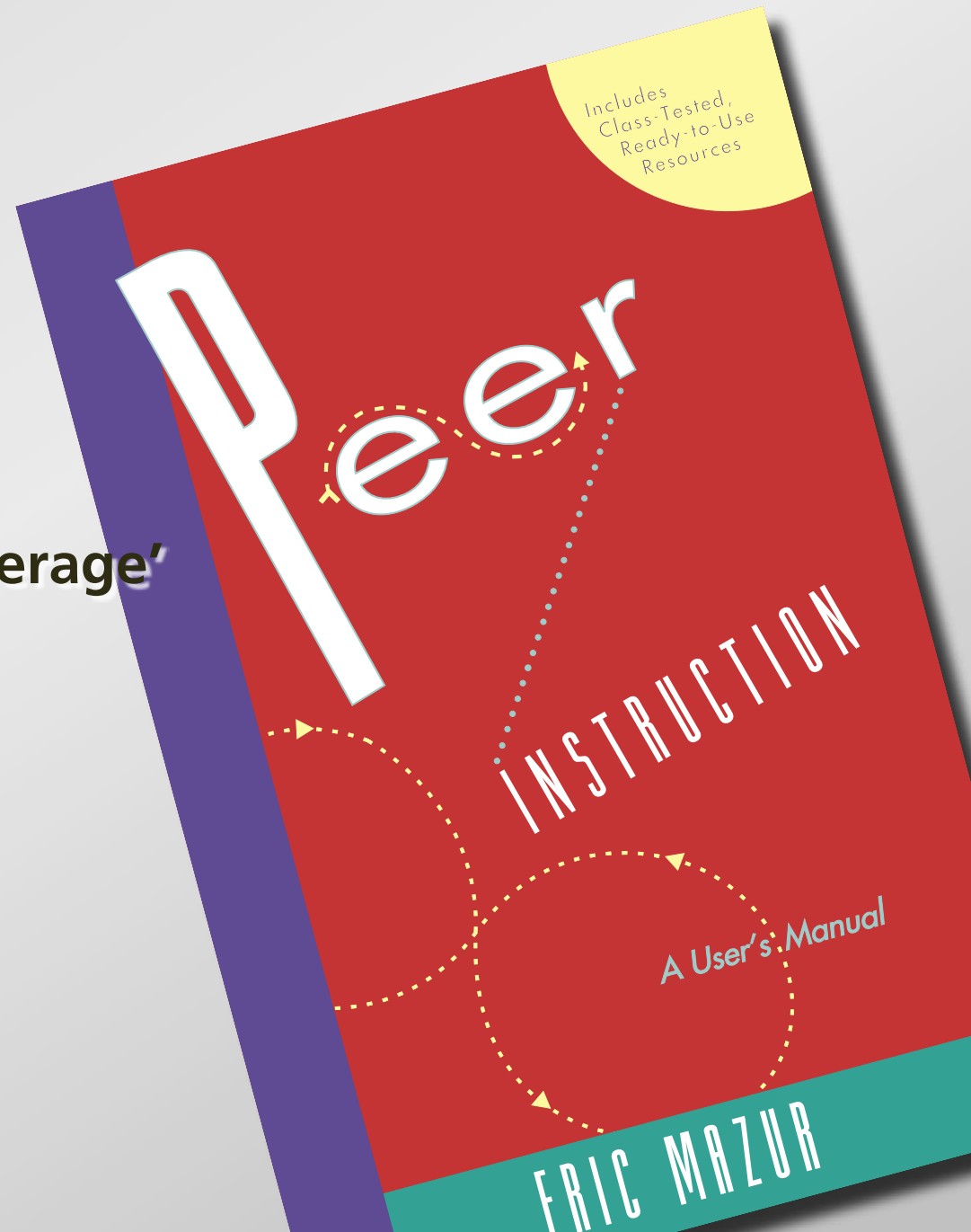

Peer Instruction

ConcepTest:

- 1. Question**
- 2. Thinking**
- 3. Individual answer**
- 4. Peer discussion**
- 5. Revised/Group answer**
- 6. Explanation**

Peer Instruction

is it any good?

Peer Instruction

first year of implementing PI

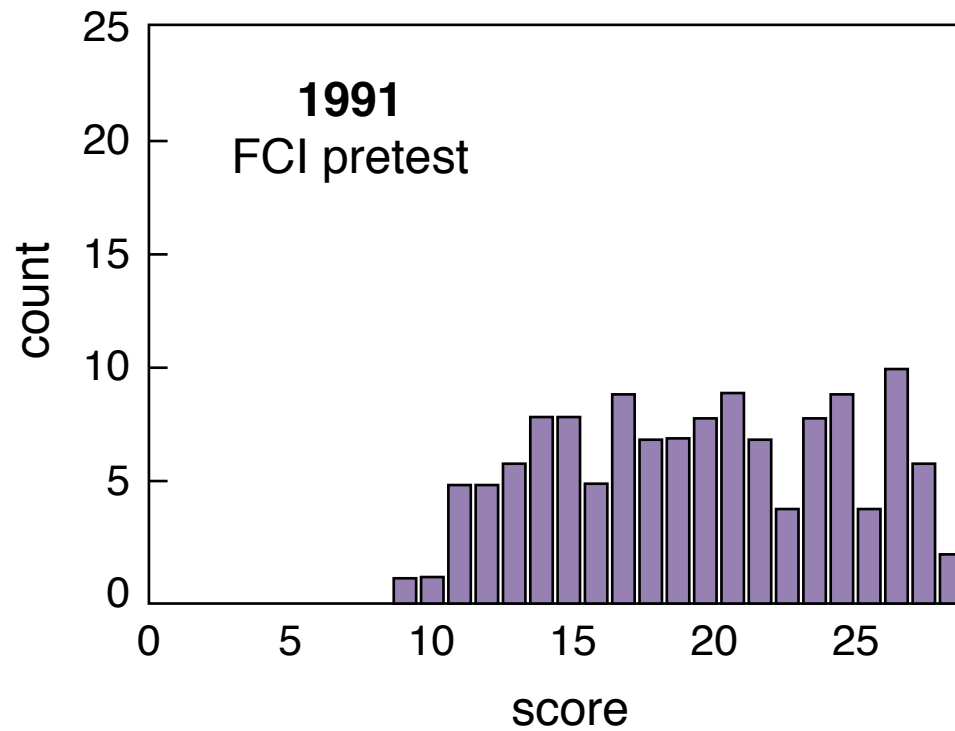

Peer Instruction

first year of implementing PI

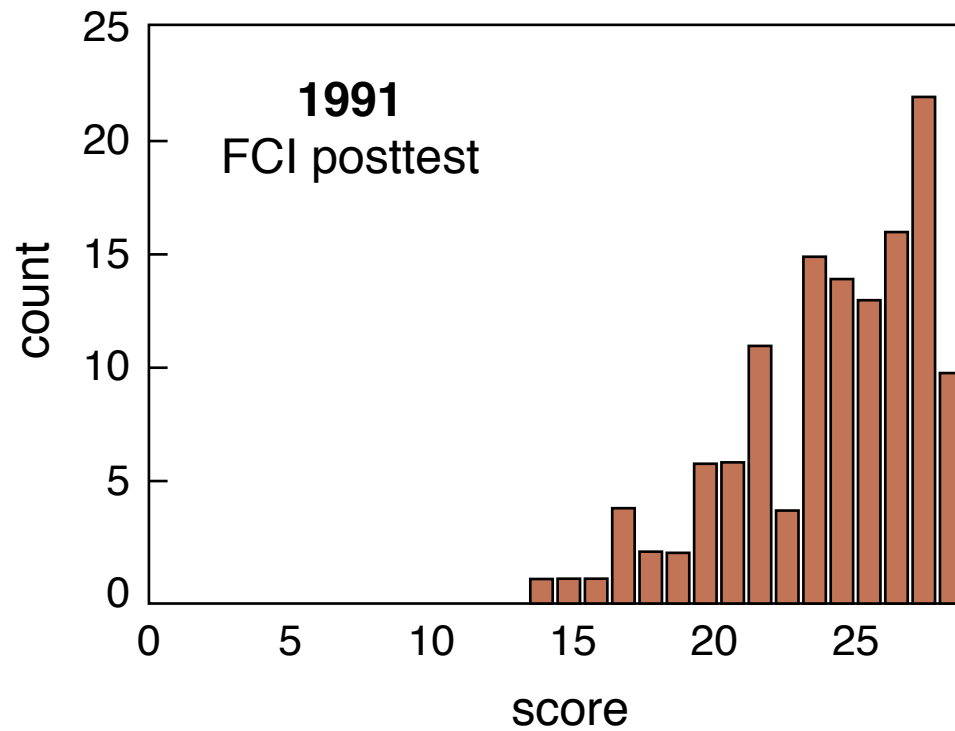

Peer Instruction

first year of implementing PI

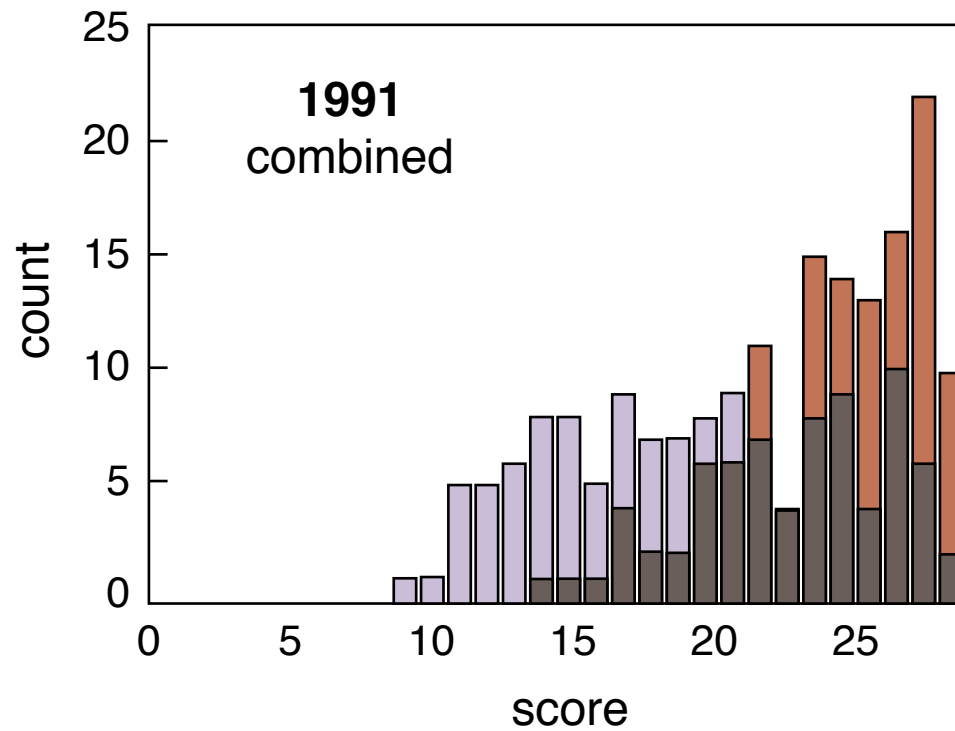

Peer Instruction

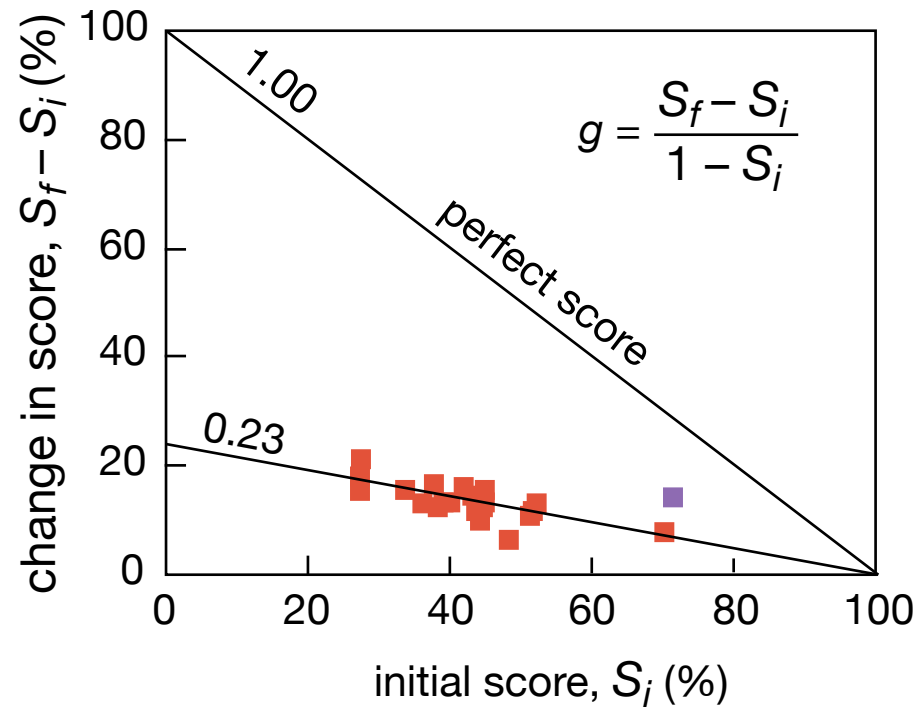

Peer Instruction

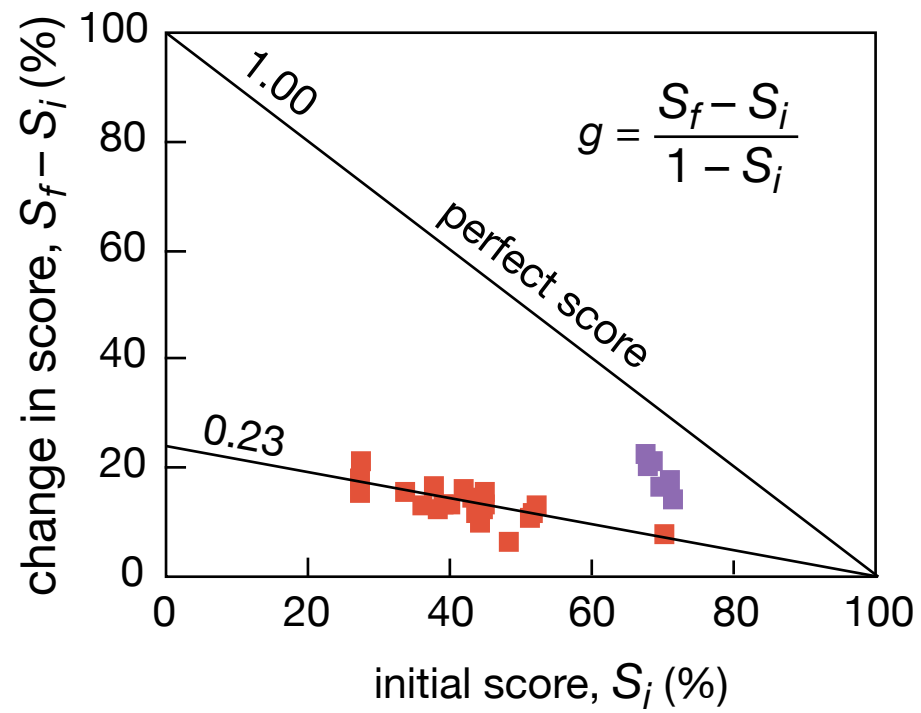

Peer Instruction

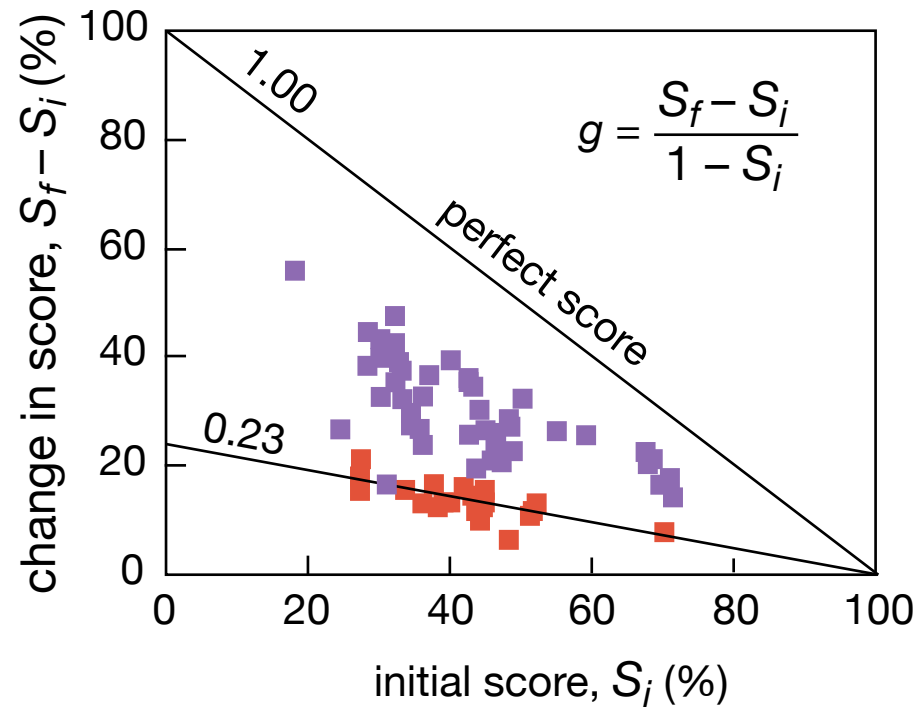

Peer Instruction

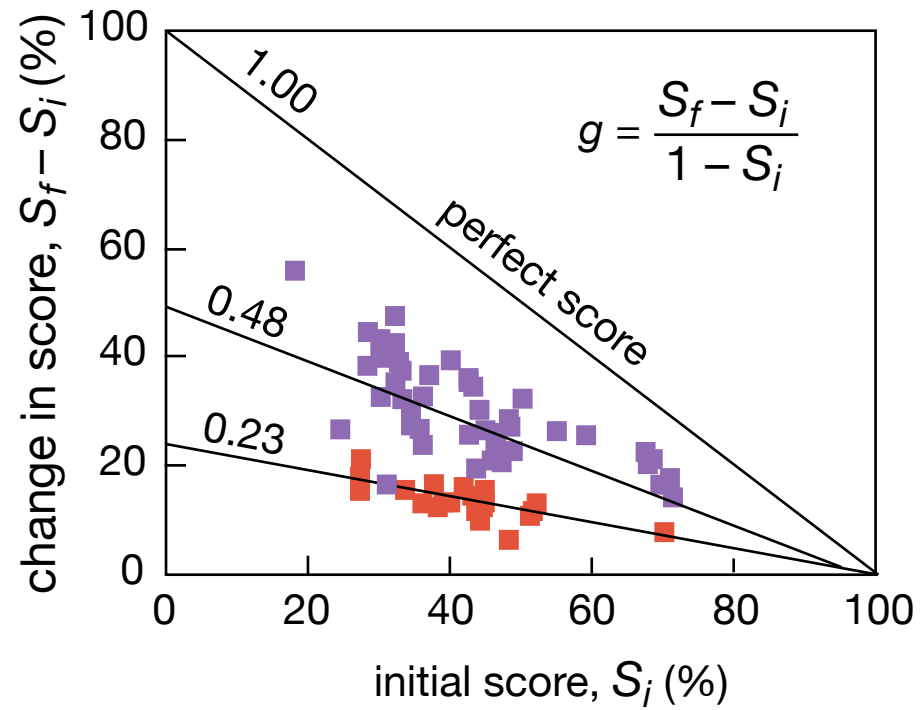

Peer Instruction

what about problem solving?

Peer Instruction

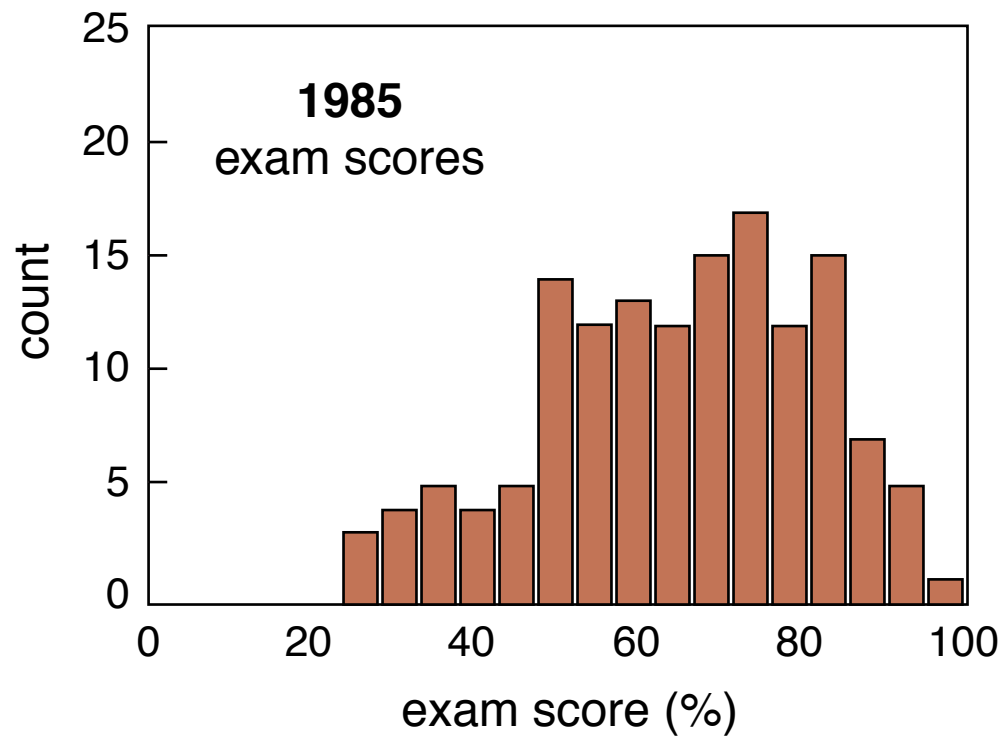

Peer Instruction

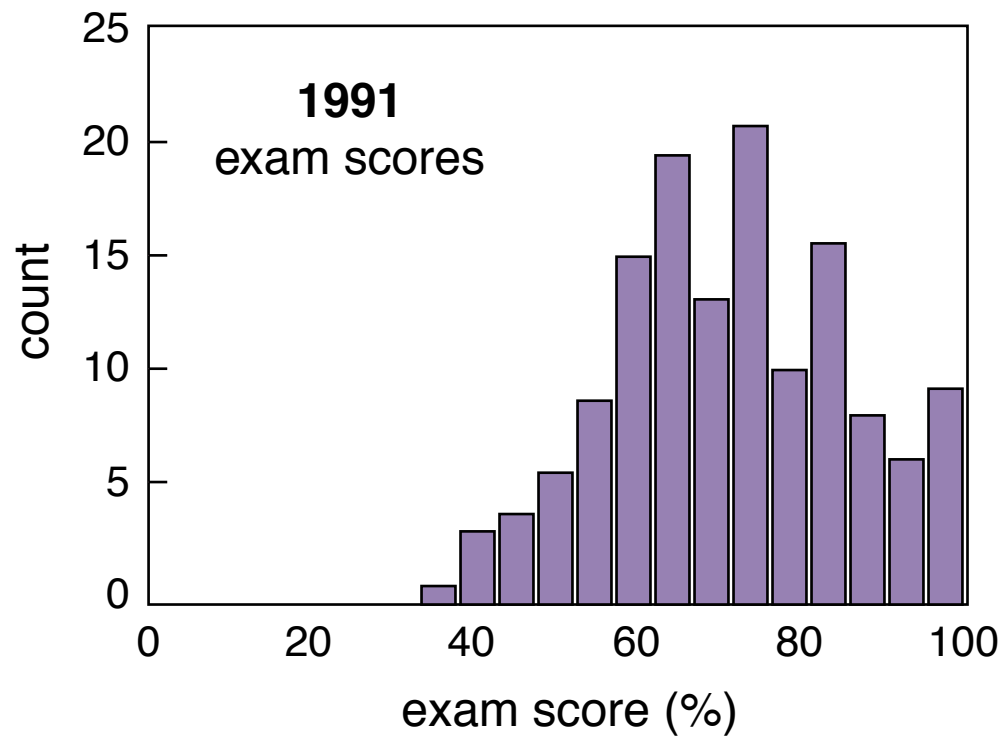

Peer Instruction

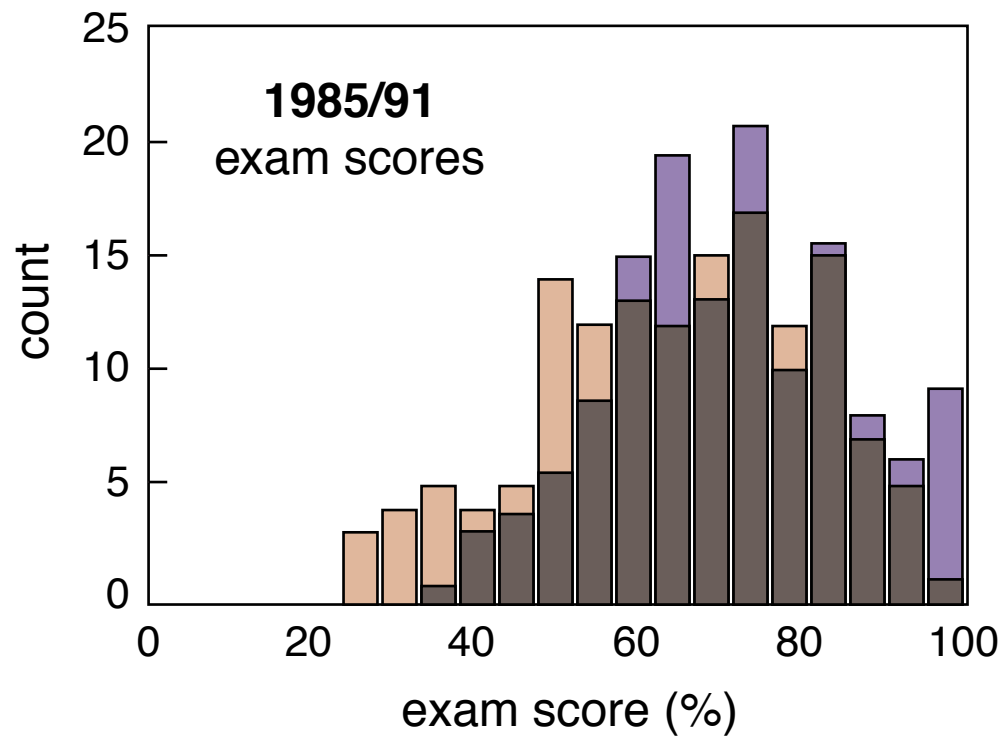

Peer Instruction

**So better understanding leads to better
problem solving!**

Peer Instruction

So better understanding leads to better problem solving!

(but “good” problem solving doesn’t always indicate understanding!)

Conclusion

Let's not forget the base
of the pyramid

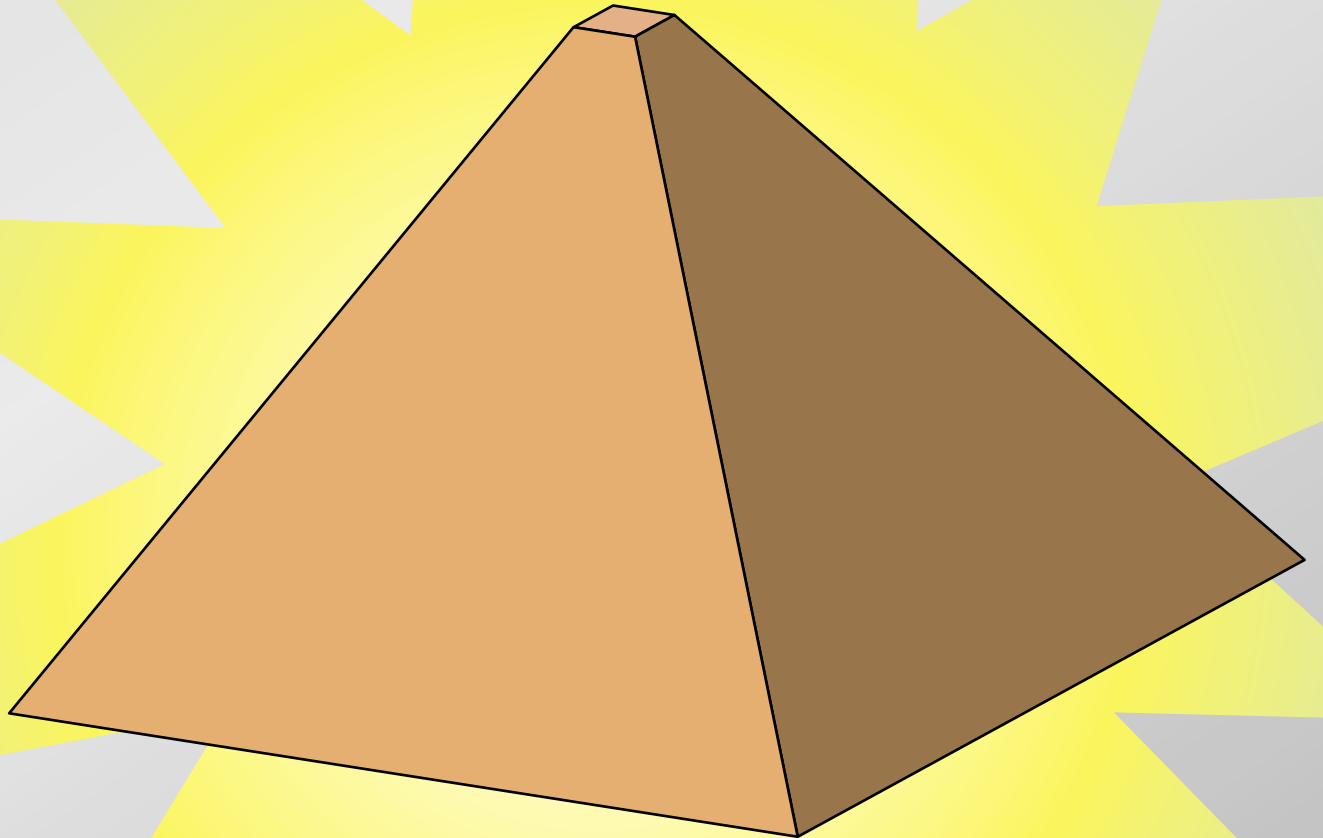

Conclusion

Let's give them something
of value!

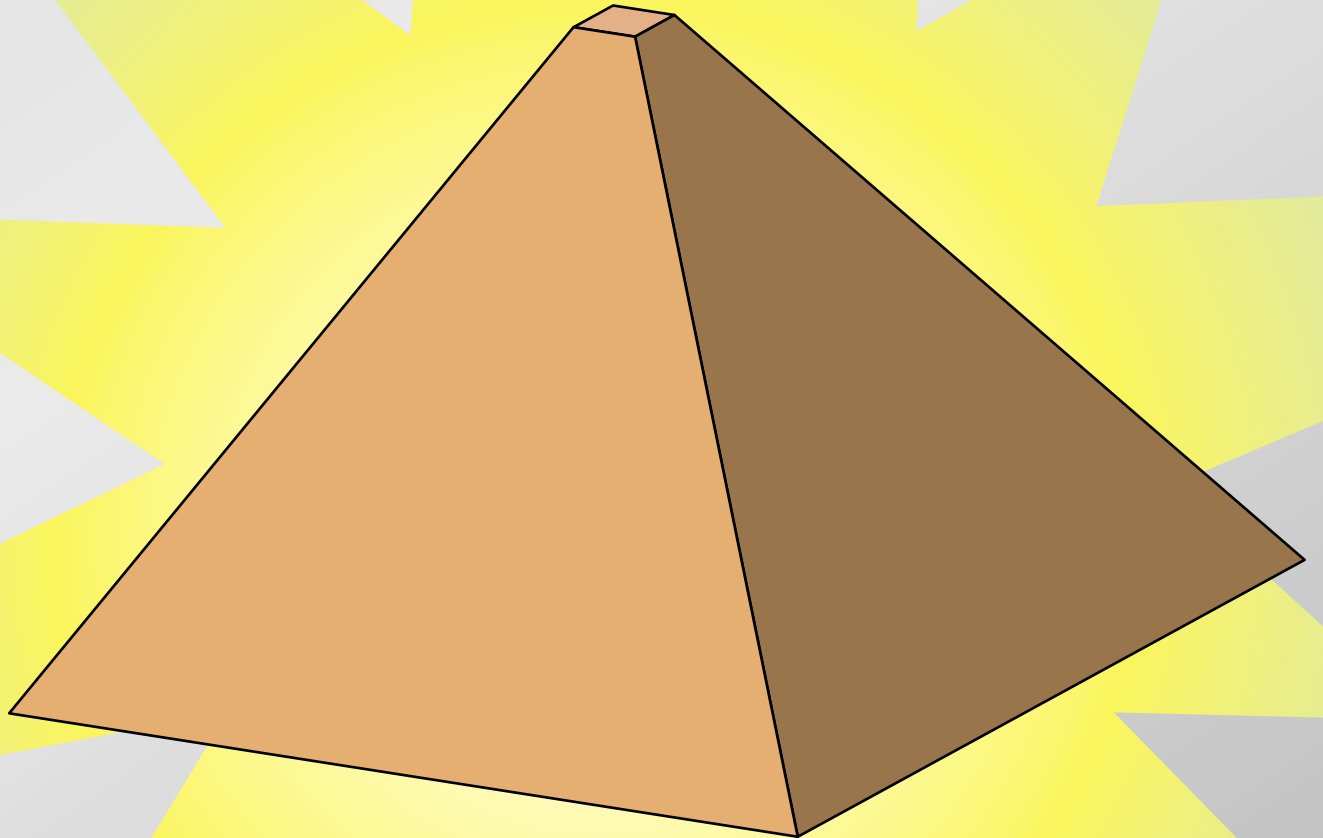

Funding:

National Science Foundation

for a copy of this presentation:

<http://mazor-www.harvard.edu>

Google™

Google Search

I'm Feeling Lucky

Google™

mazur

Google Search

I'm Feeling Lucky

Google™

mazur

Google Search

I'm Feeling Lucky

Google™

Google Search

I'm Feeling Lucky

Funding:

National Science Foundation

for a copy of this presentation:

<http://mazor-www.harvard.edu>