

Confessions of a converted lecturer



Concordia University
Montreal, Canada, 17 January 2008



My message

shift focus from "teaching" to helping students learn

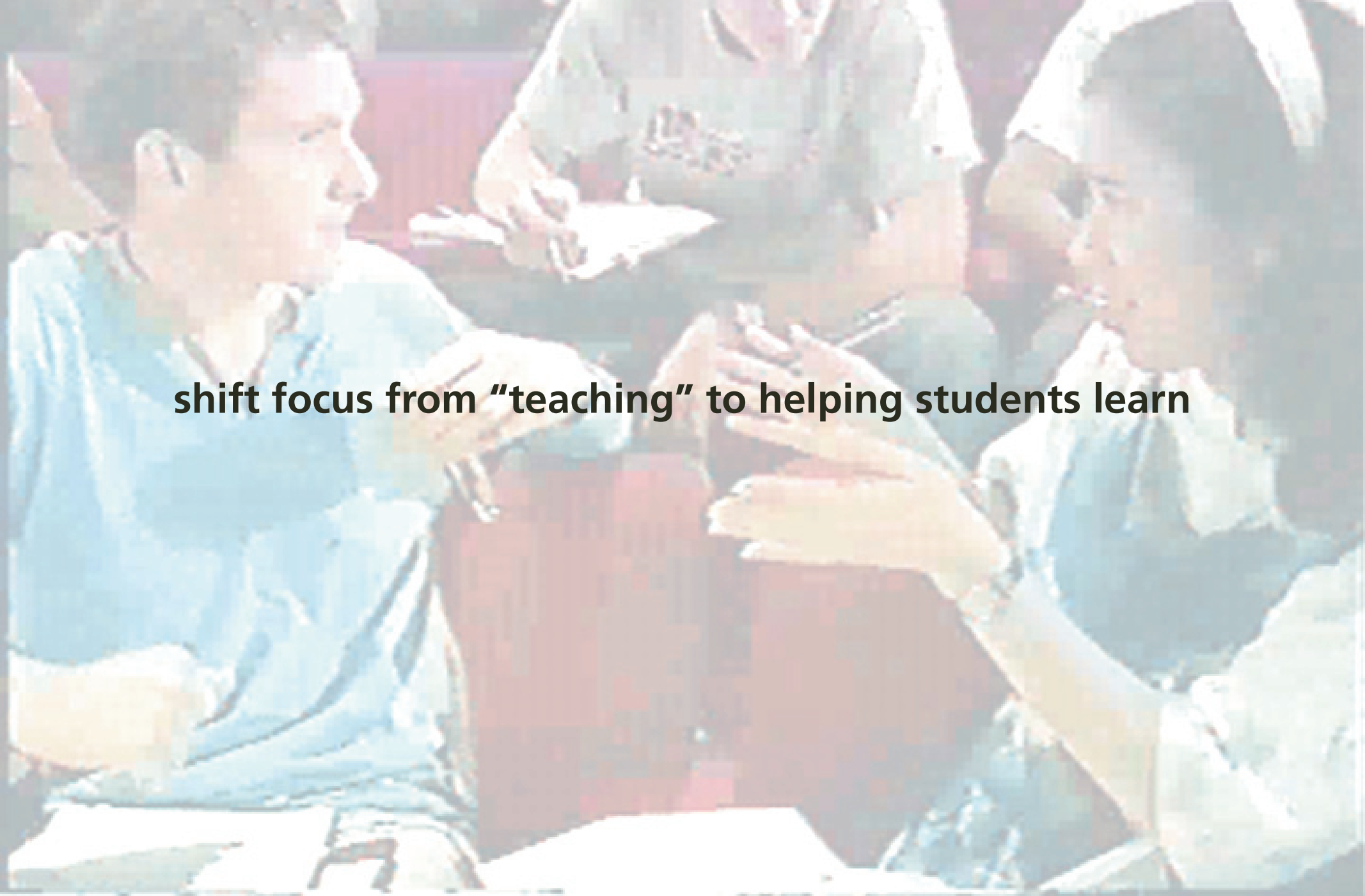

Outline

- Education



Outline

- Education
- Peer Instruction



Outline

- Education
- Peer Instruction
- Results



Education



Education

lectures focus on delivery of information

A large lecture hall with students seated at desks, facing a stage where a lecturer is presenting. A large screen displays text and a map. The room is filled with students, and the lecturer is standing at a podium on the stage. The screen shows a map of the world and some text, likely related to the lecture topic.

Education

education is not just information transfer

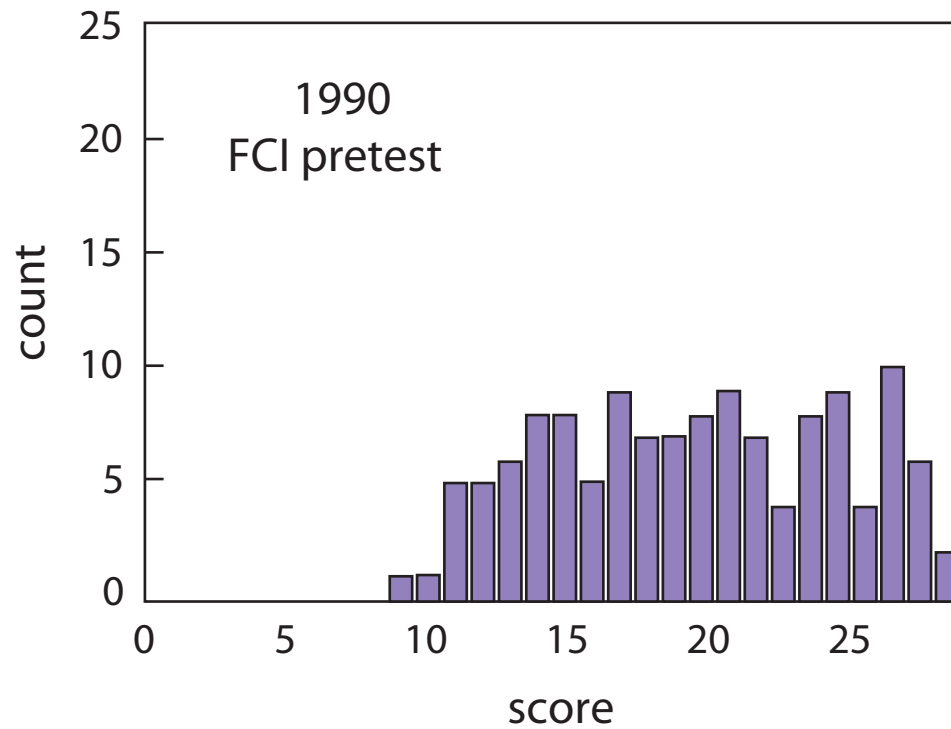

Education

education is not just information transfer

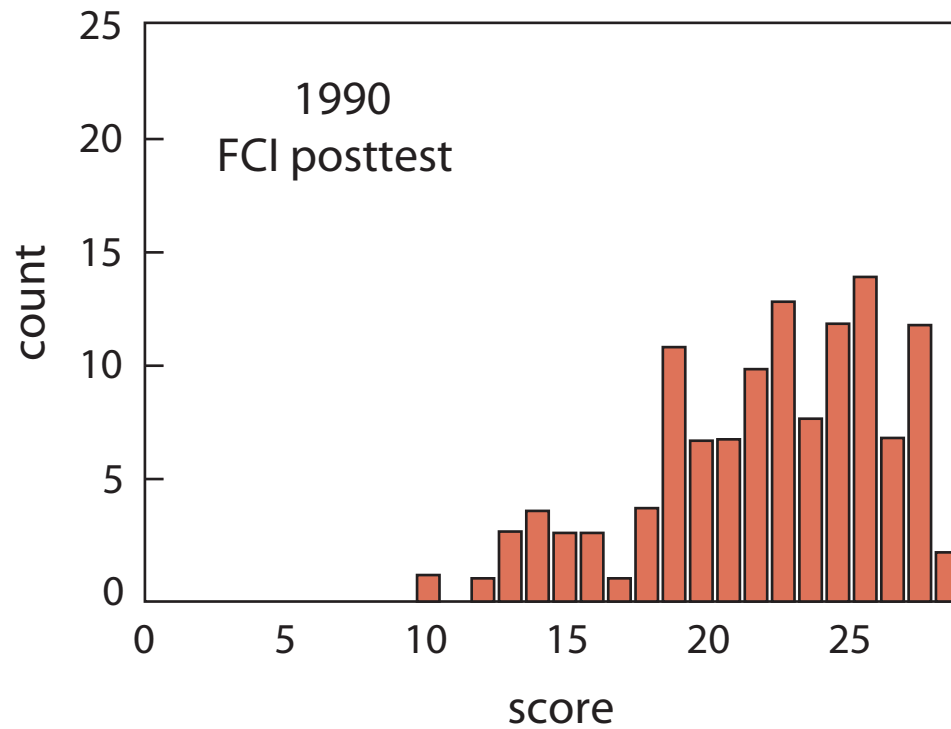

Education

education is not just information transfer

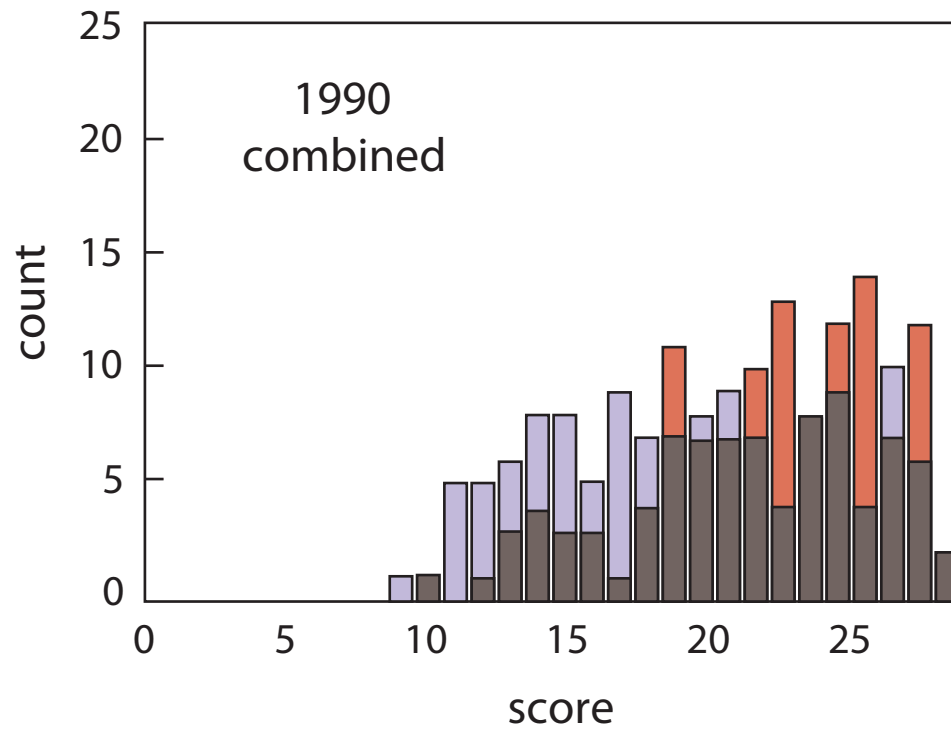

Education

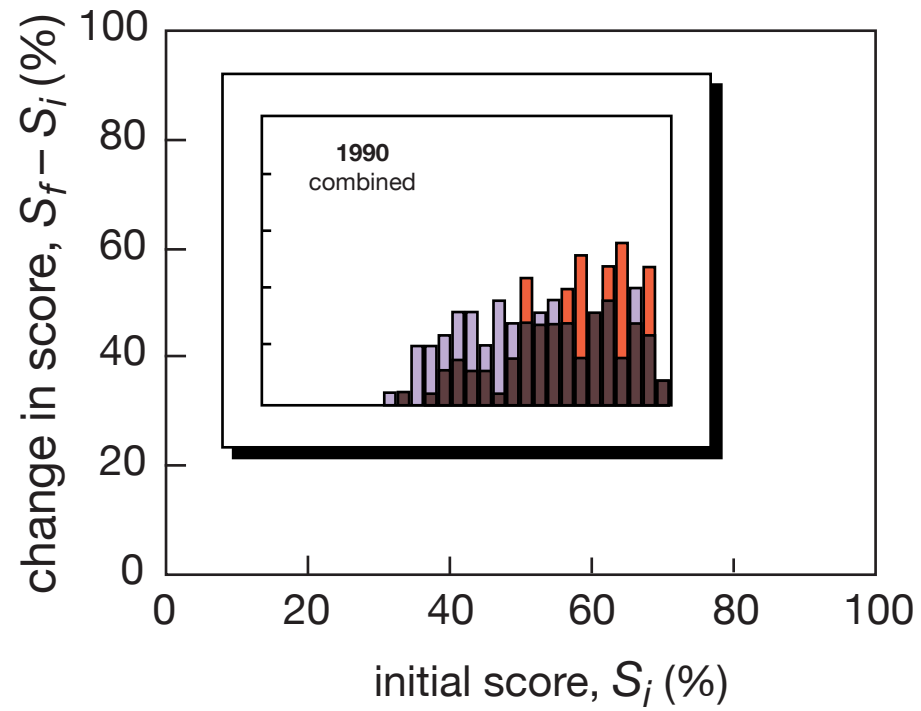

Education

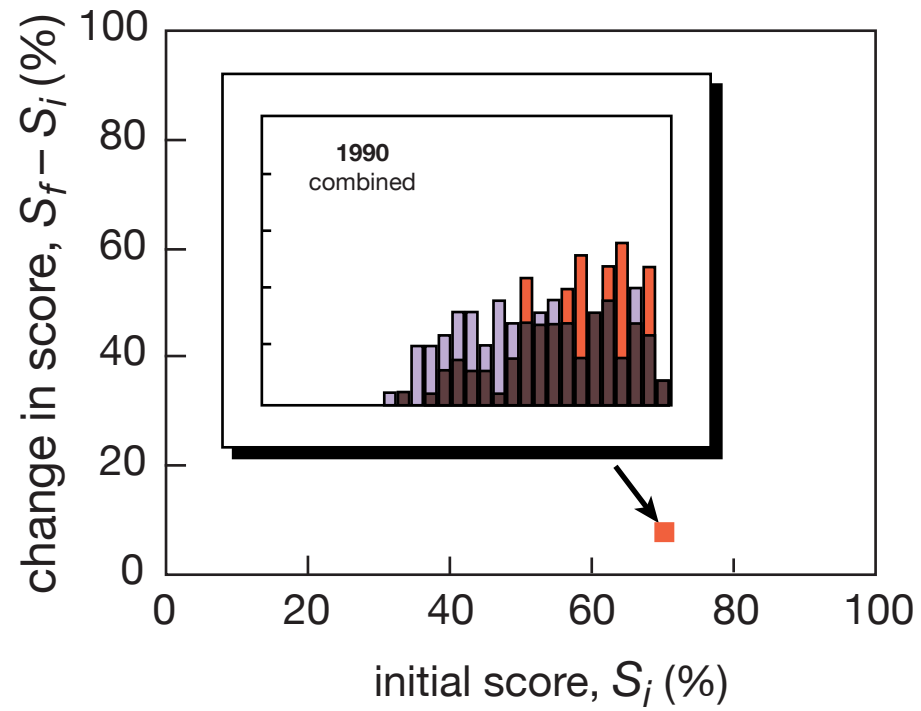

Education

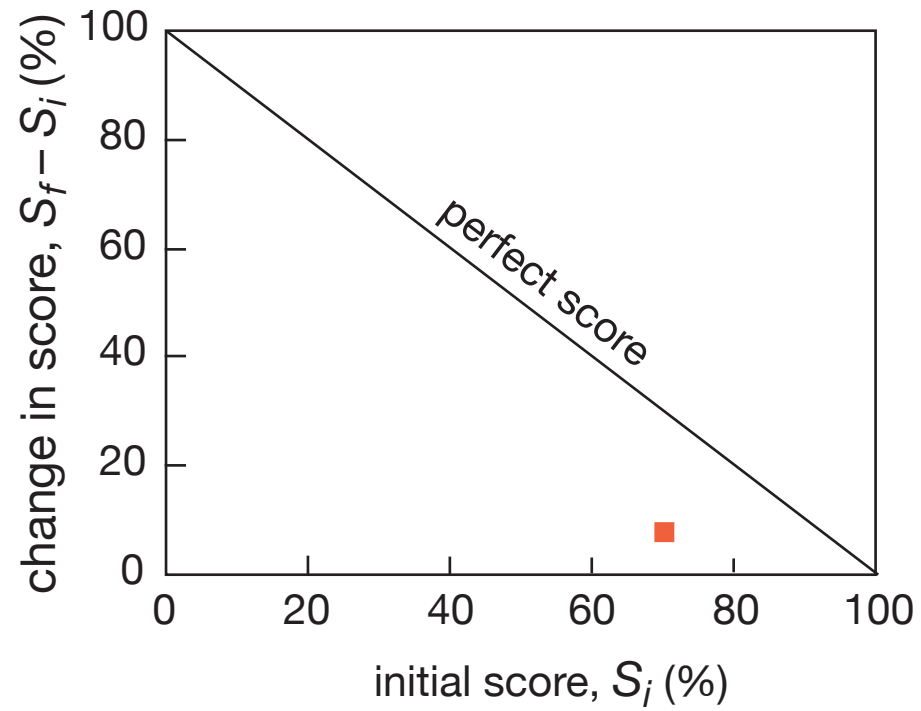

Education

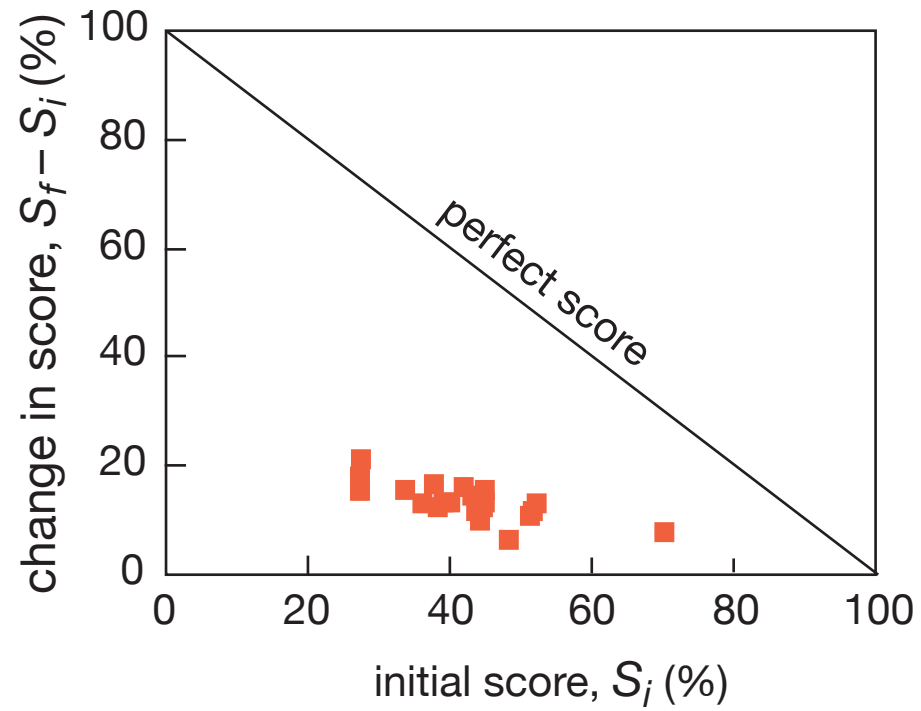

Education

only one quarter of maximum gain realized

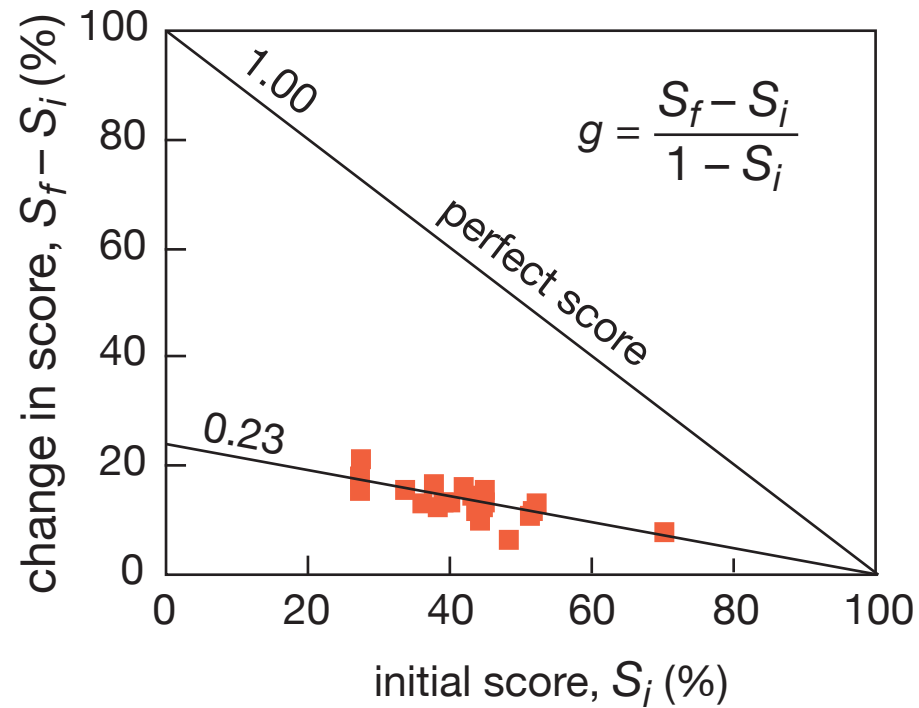

Education

not transfer but assimilation of information is key

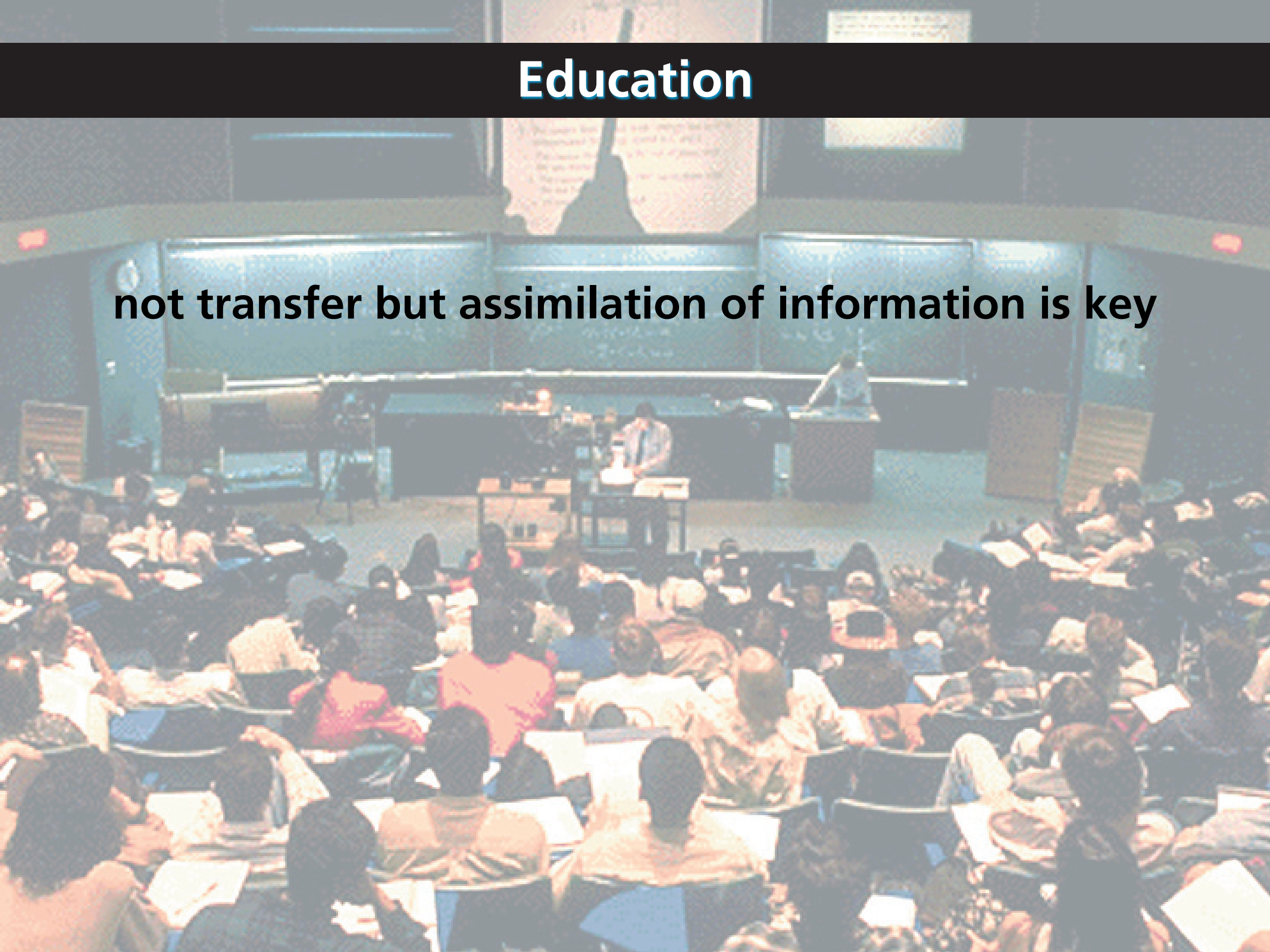

Education

conventional problems misleading

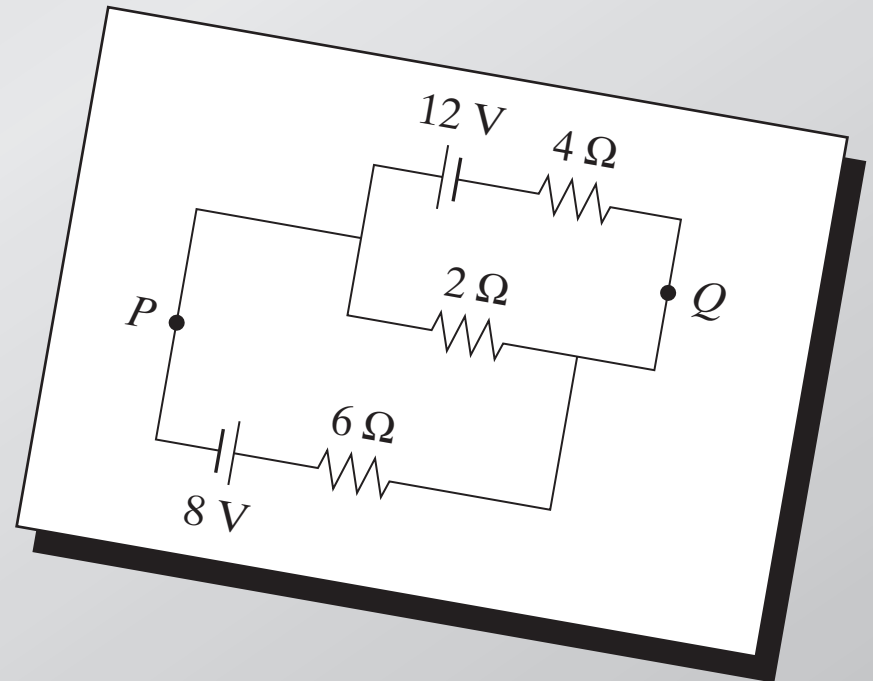

Education

conventional problems misleading

Calculate:

(a) current in 2- Ω resistor

(b) potential difference

between P and Q

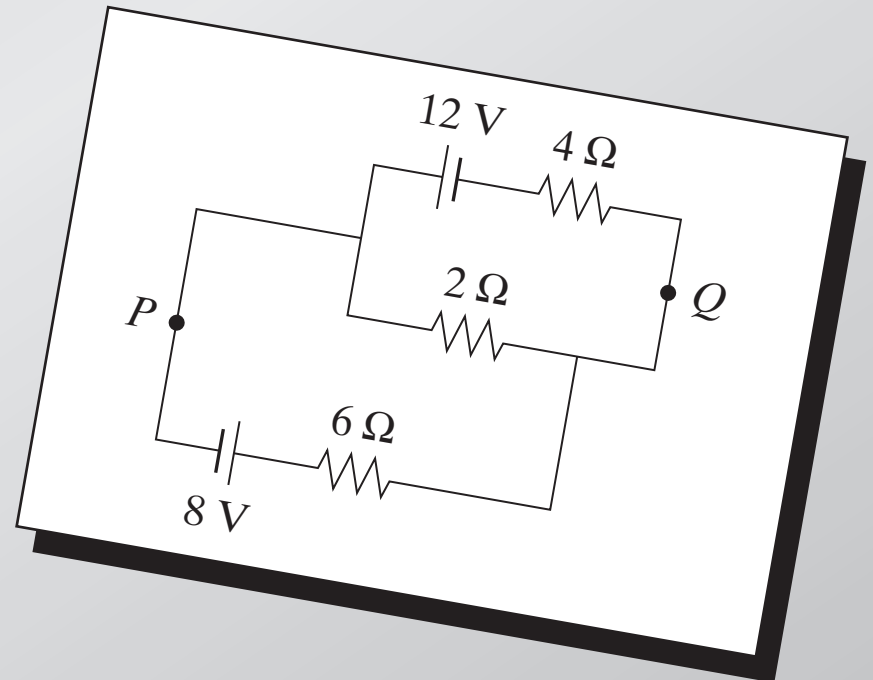

Education

are the basic principles understood?

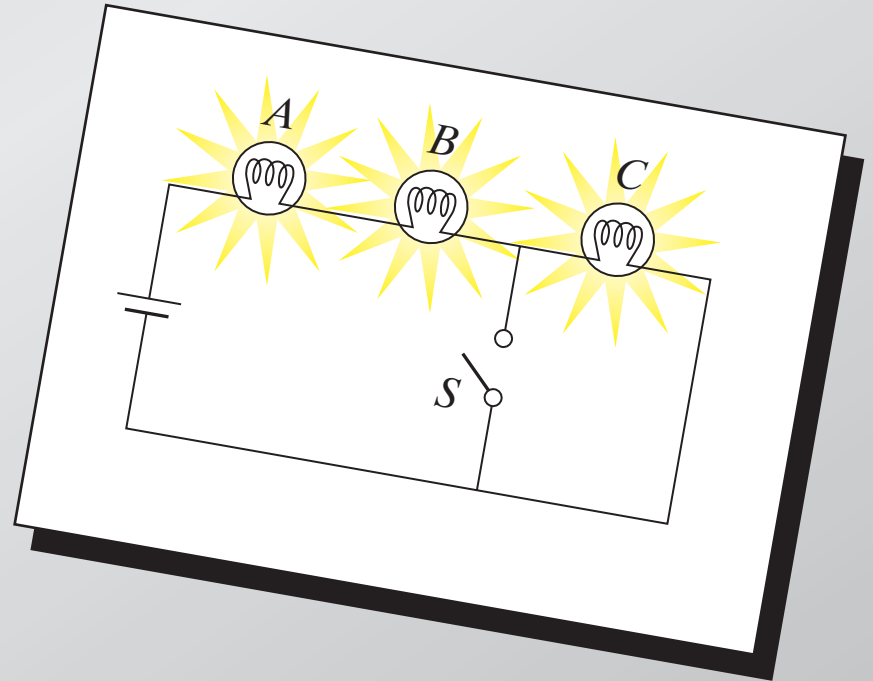

Education

are the basic principles understood?

When S is closed, what happens to:

- (a) intensities of A and B ?
- (b) intensity of C ?
- (c) current through battery?
- (d) potential difference across
 A , B , and C ?
- (e) the total power dissipated?

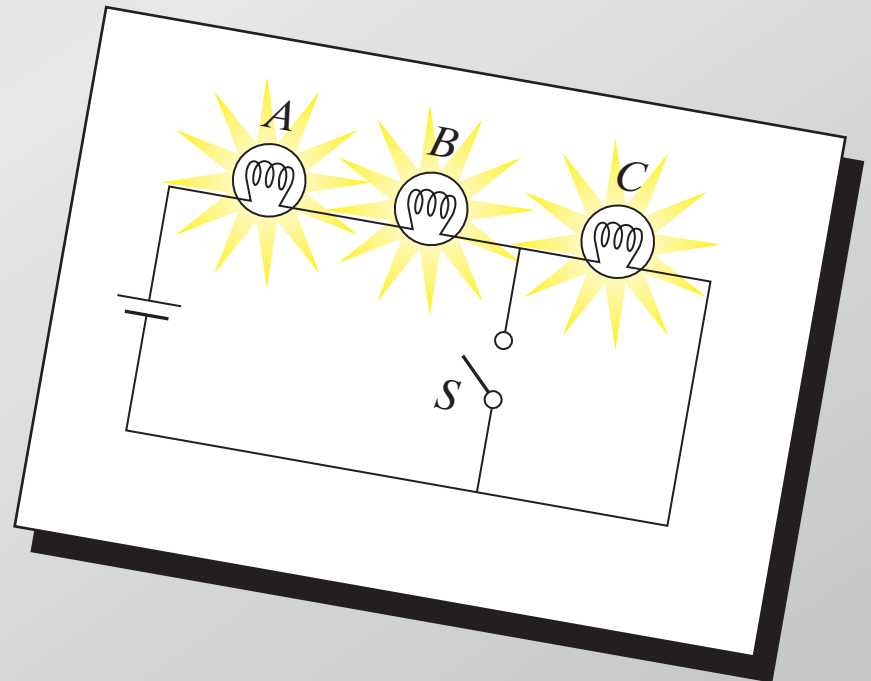

Education

conventional

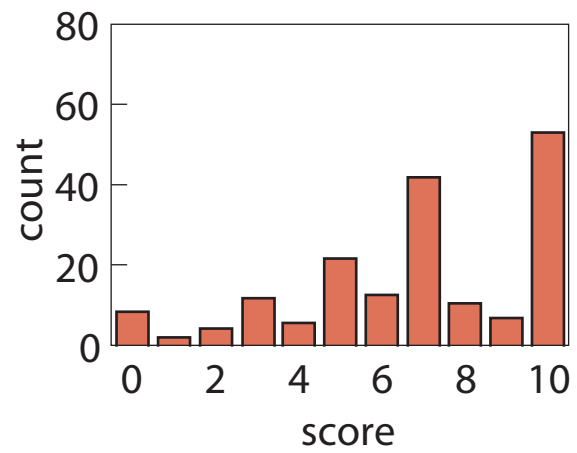

conceptual

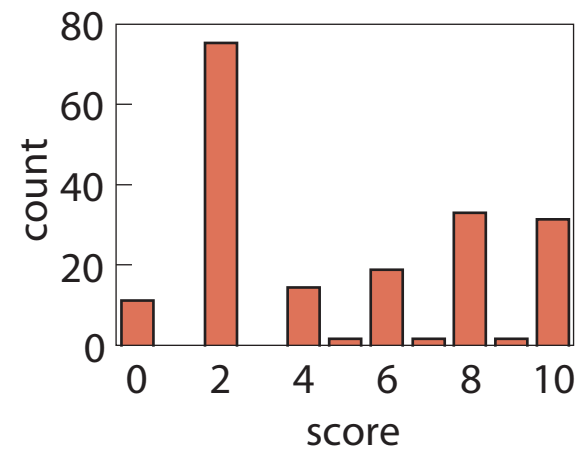

Education

conventional

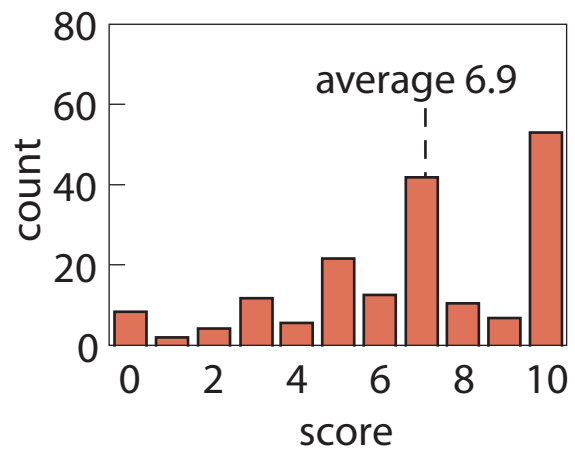

conceptual

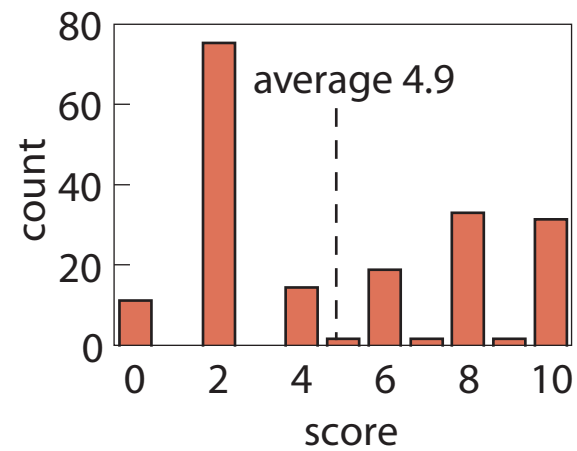

Education

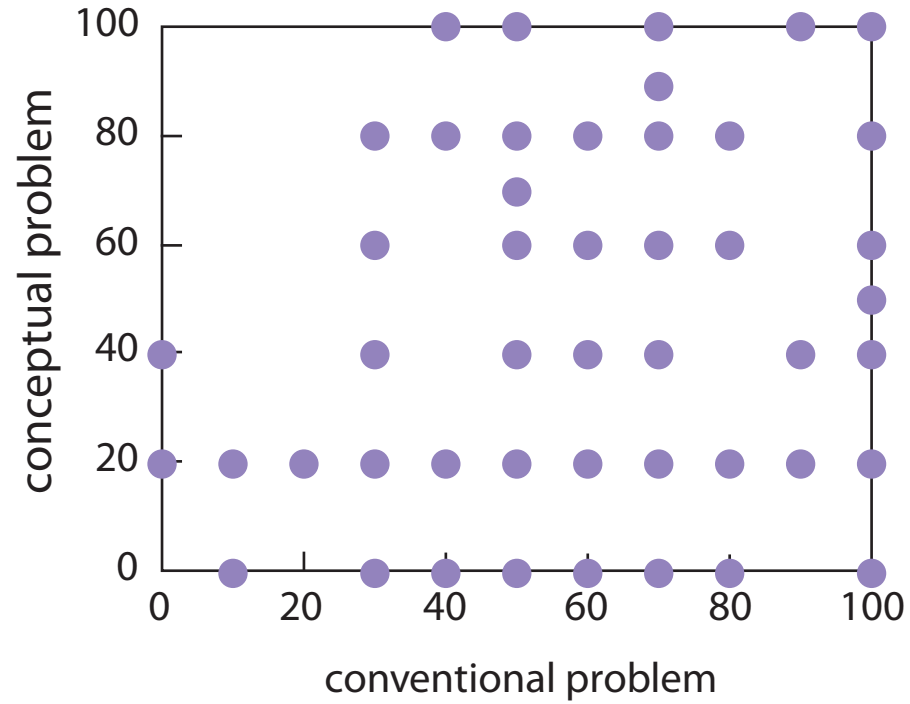

Education

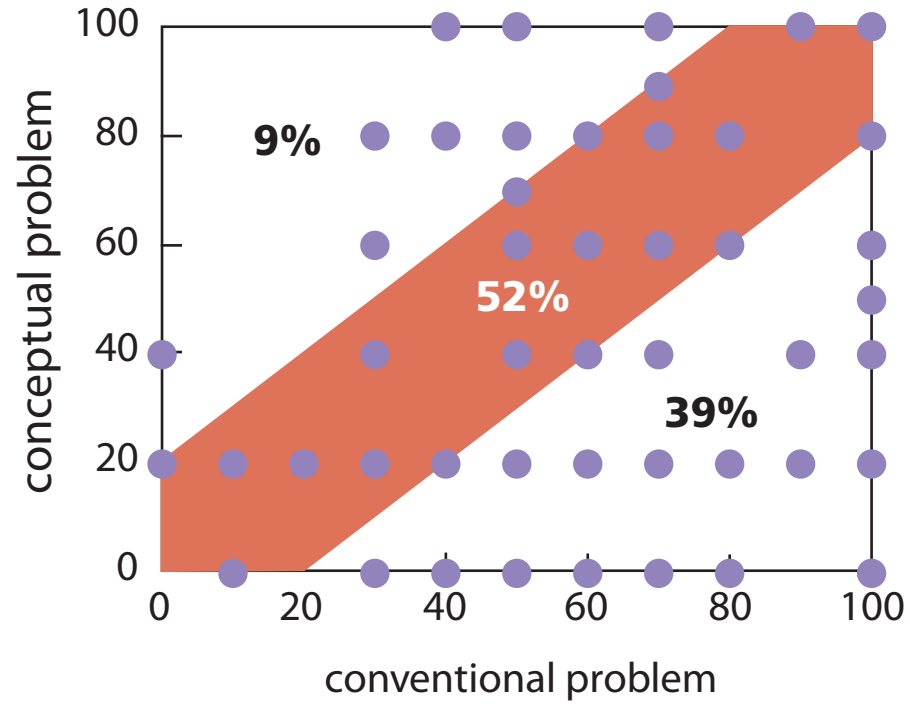

A large lecture hall with students seated at desks, facing a stage with a lecturer and a large screen displaying text. The text on the screen is partially legible and appears to be a list of items or a document. The room is dimly lit, with the stage area being the primary light source. The students are mostly seen from behind, looking towards the front of the room. The lecturer is standing at a podium on the stage, facing the audience. The overall atmosphere is that of a formal academic setting.

So what should we do?

Peer Instruction

Give students more responsibility for gathering information...

Peer Instruction

**Give students more responsibility for gathering information...
so we can better help them assimilate it.**

Peer Instruction

Main features:

- pre-class reading
- in-class: depth, not 'coverage'
- ConcepTests

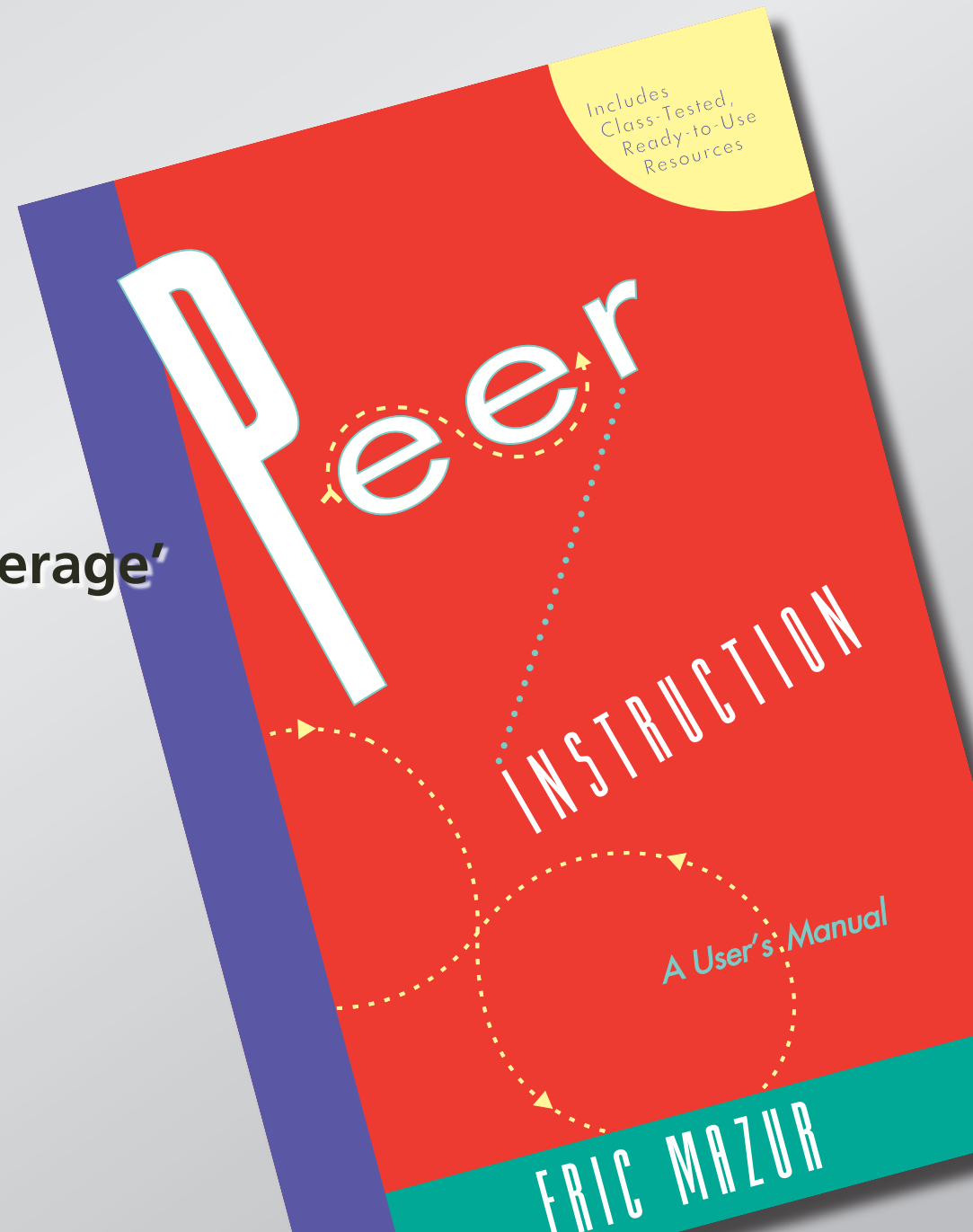

Peer Instruction

ConcepTest:

- 1. Question**
- 2. Thinking**
- 3. Individual answer**
- 4. Peer discussion**
- 5. Revised/Group answer**
- 6. Explanation**

Results

is it any good?

Results

first year of implementing PI

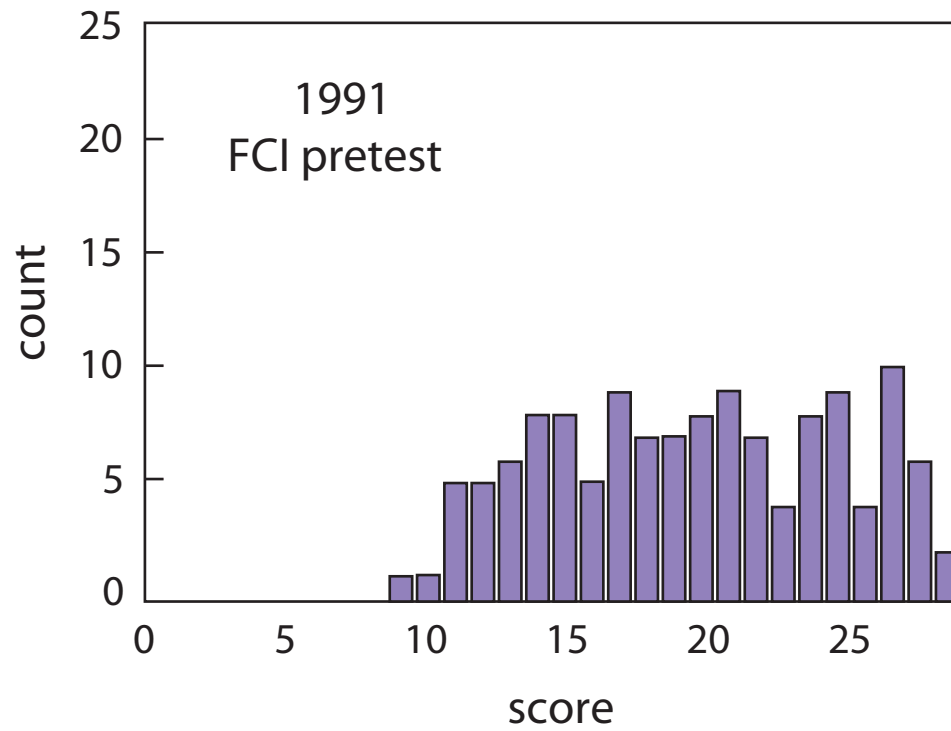

Results

first year of implementing PI

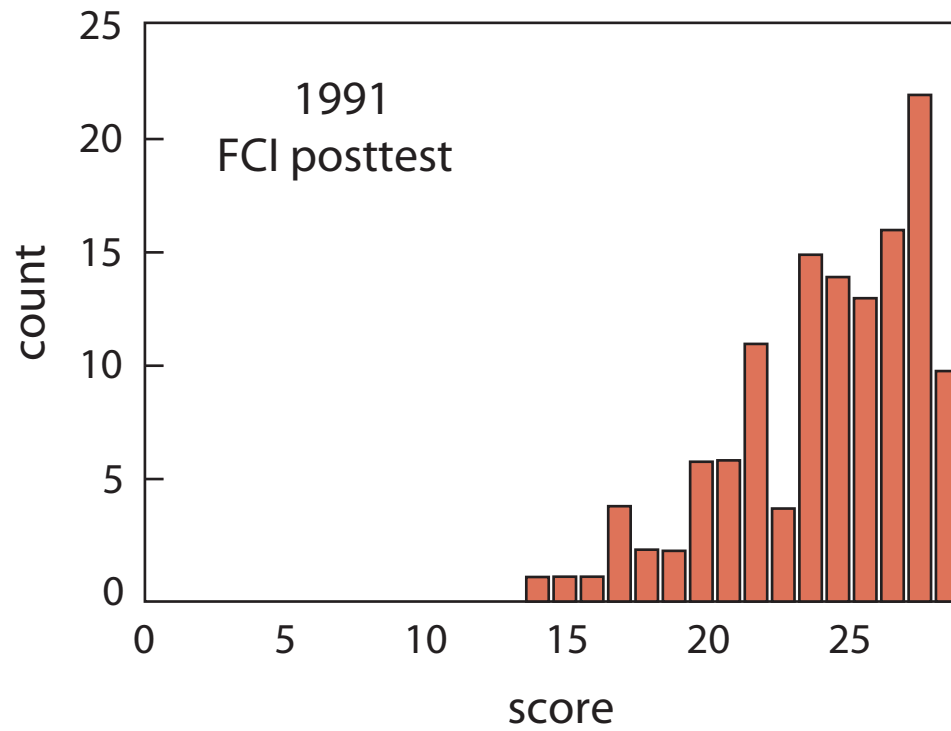

Results

first year of implementing PI

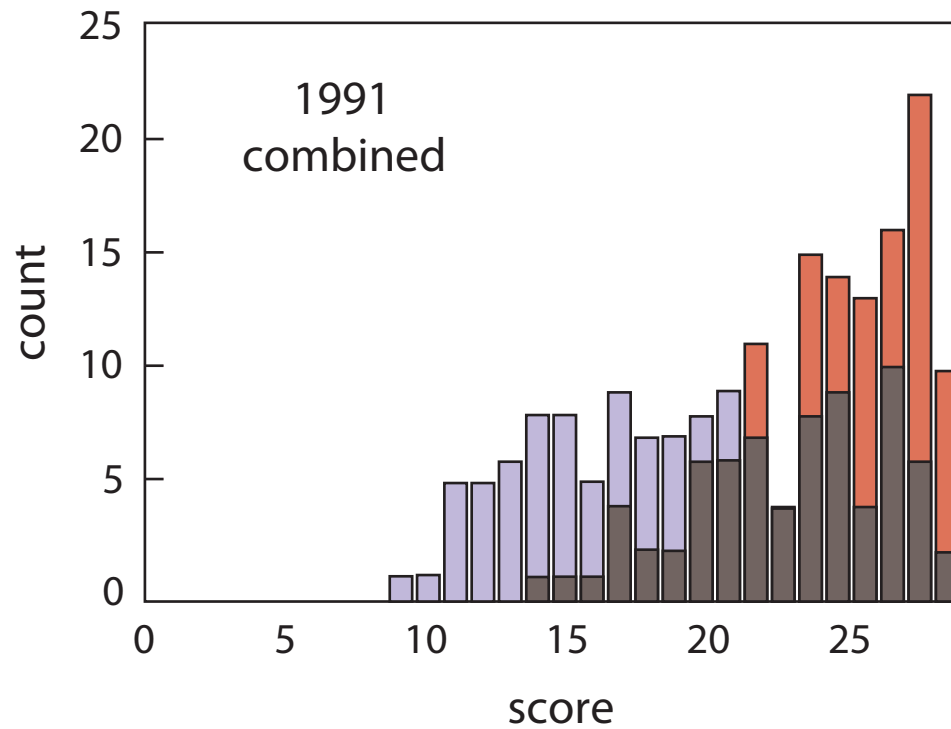

Results

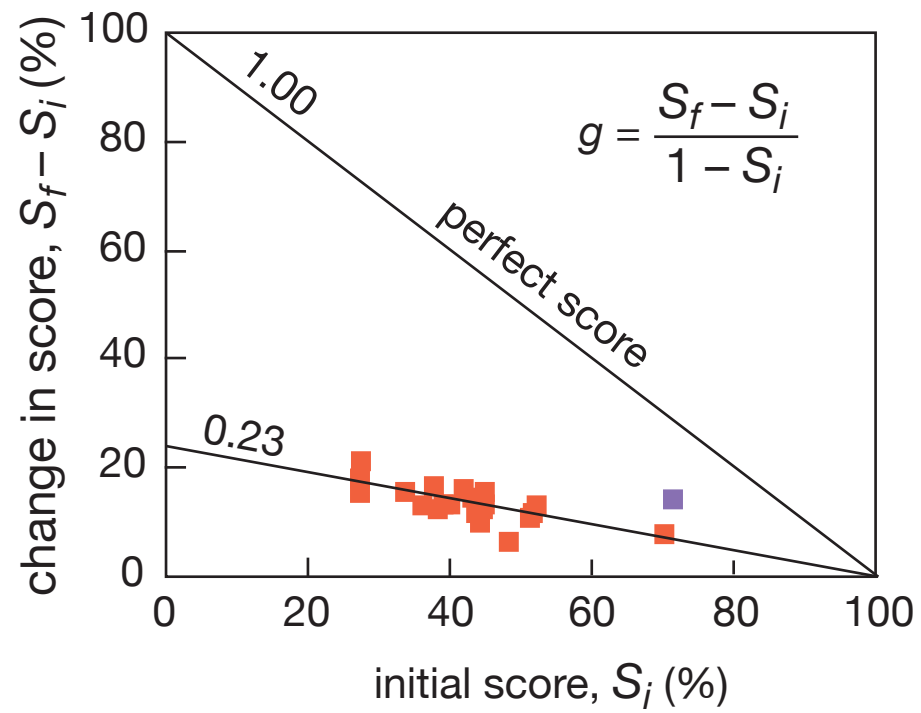

Results

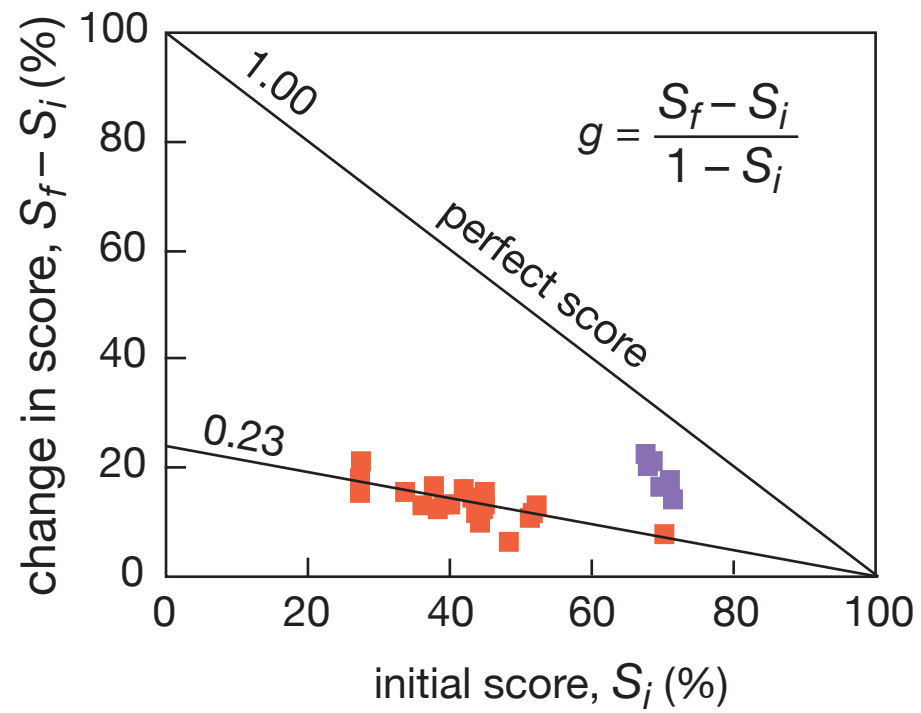

Results

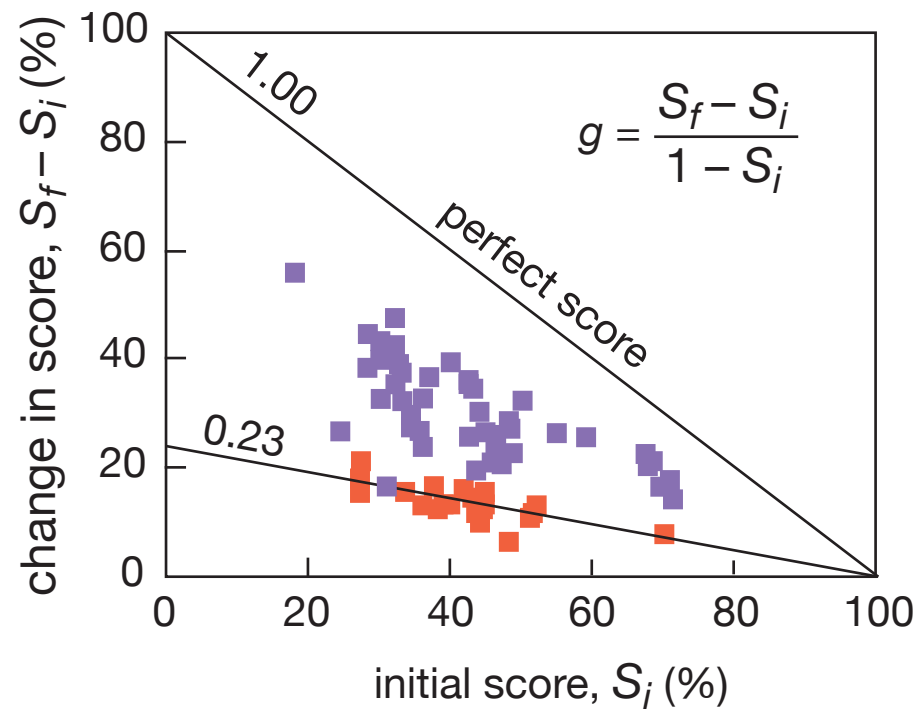

Results

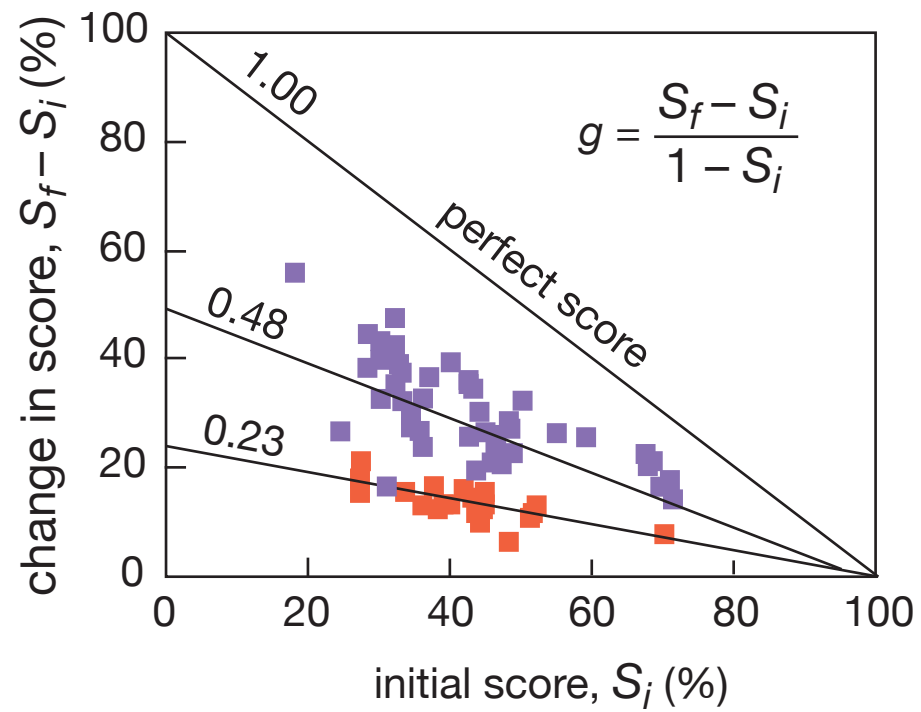

Results

what about problem solving?

Results

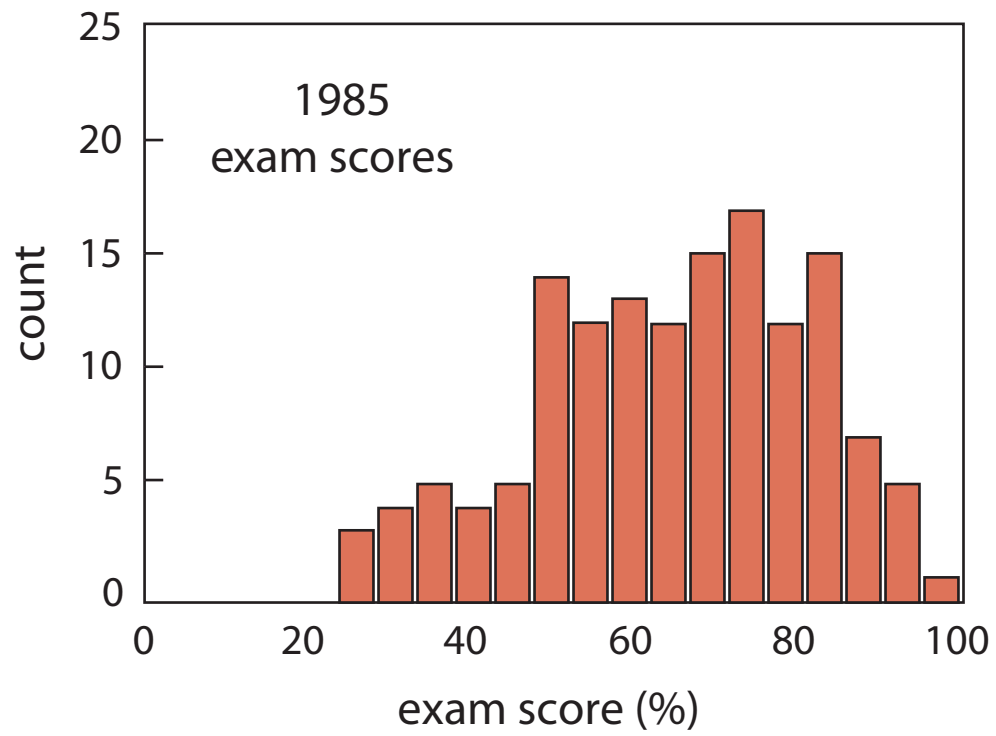

Results

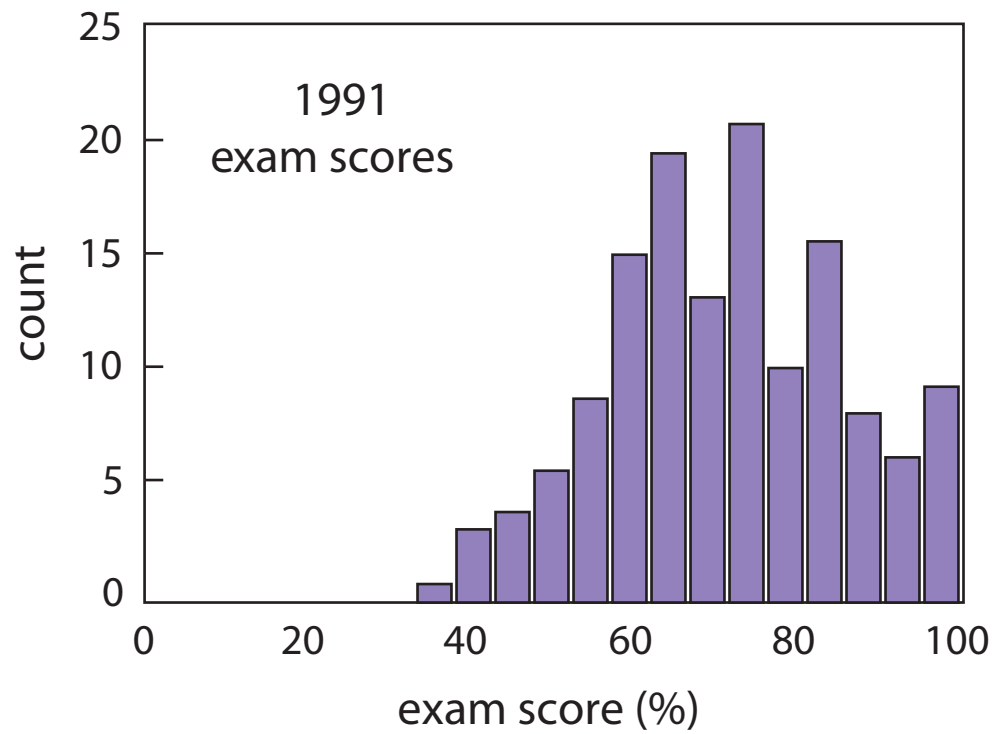

Results

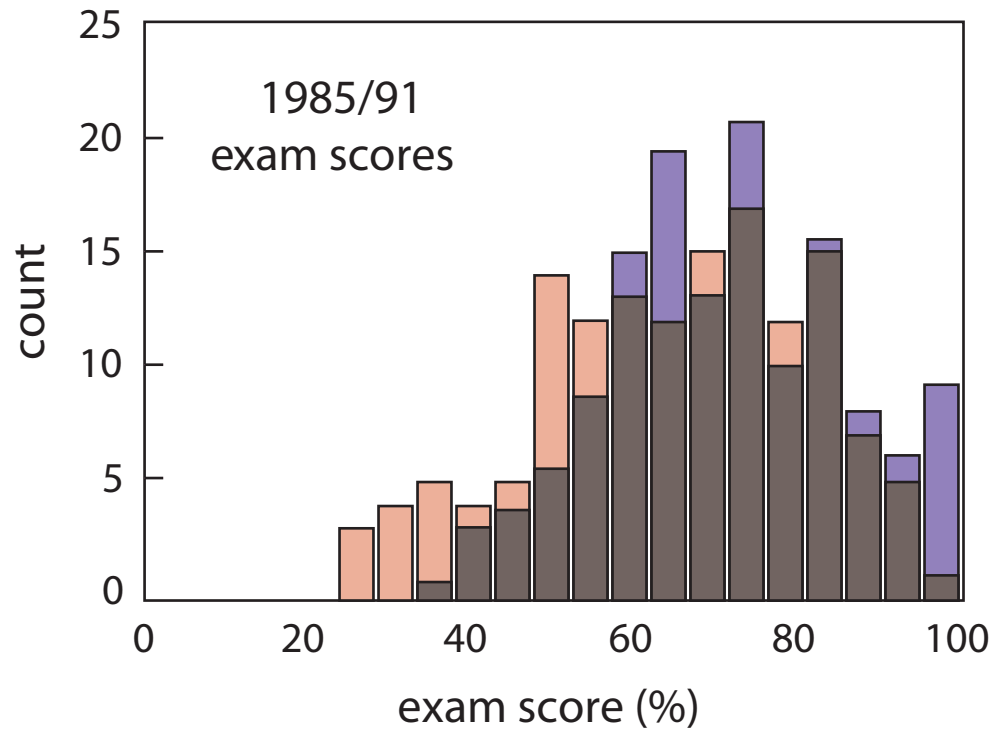

Summary

**So better understanding leads to better
problem solving!**

Summary

So better understanding leads to better problem solving!

(but “good” problem solving doesn’t always indicate understanding!)

Funding:

National Science Foundation

for a copy of this presentation:

<http://mazur-www.harvard.edu>

Google™

Google Search

I'm Feeling Lucky

Google™

mazur

Google Search

I'm Feeling Lucky

Google™

mazur

Google Search

I'm Feeling Lucky

Google™

Google Search

I'm Feeling Lucky

Funding:

National Science Foundation

for a copy of this presentation:

<http://mazur-www.harvard.edu>