

# Confessions of a converted lecturer



Harvard University  
Cambridge, MA, 28 September 2009



# My message

**shift focus from "teaching" to helping students learn**





# Outline

- Education



# Outline

- Education
- Peer Instruction



# Outline

- Education
- Peer Instruction
- Results



# Education



# Education

lectures focus on delivery of information

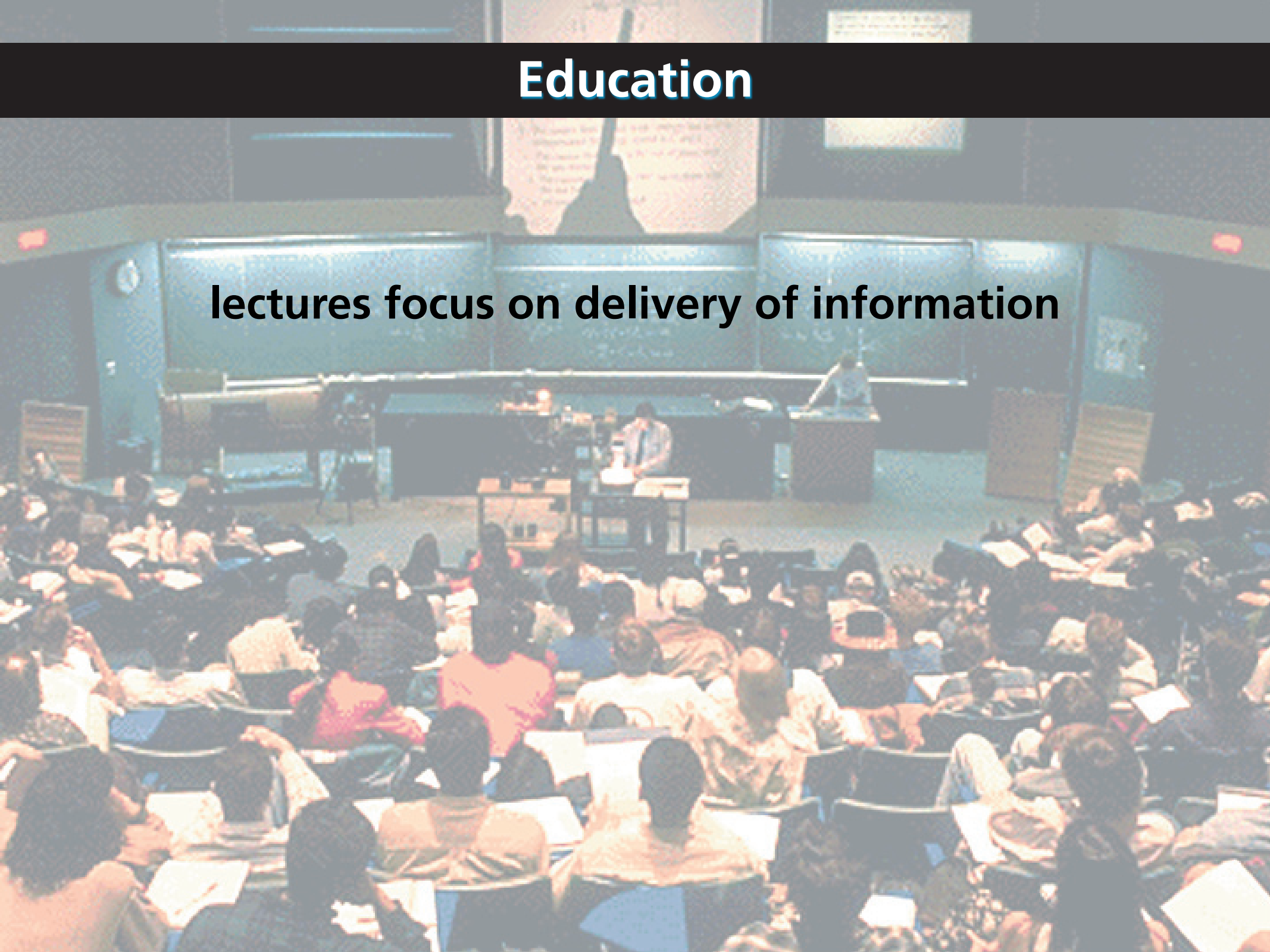

# Education

education is not just information transfer

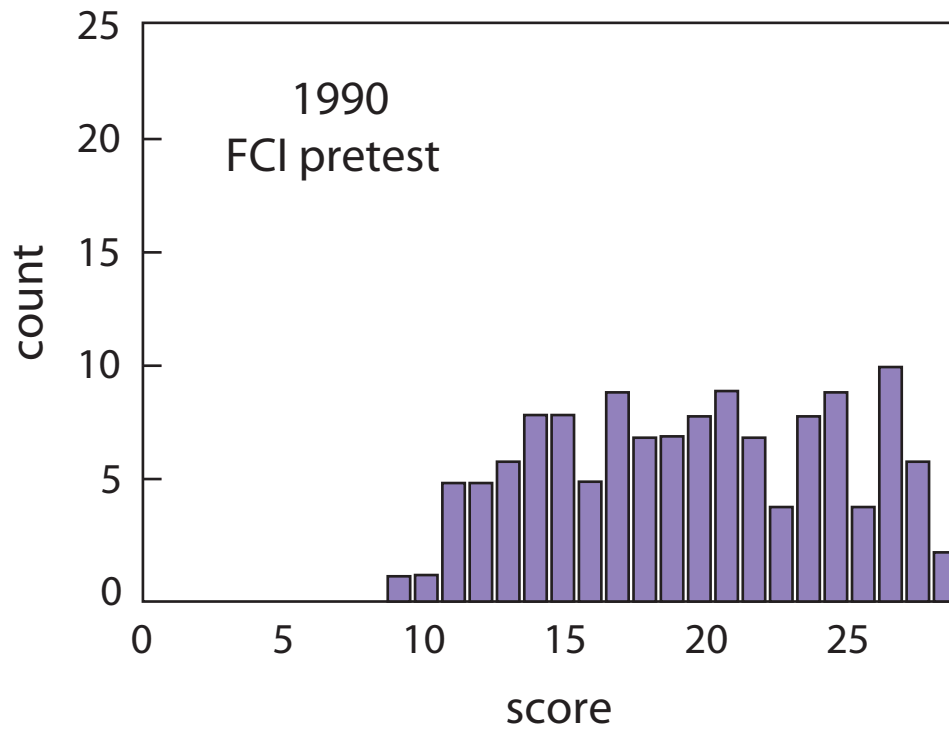



# Education

education is not just information transfer

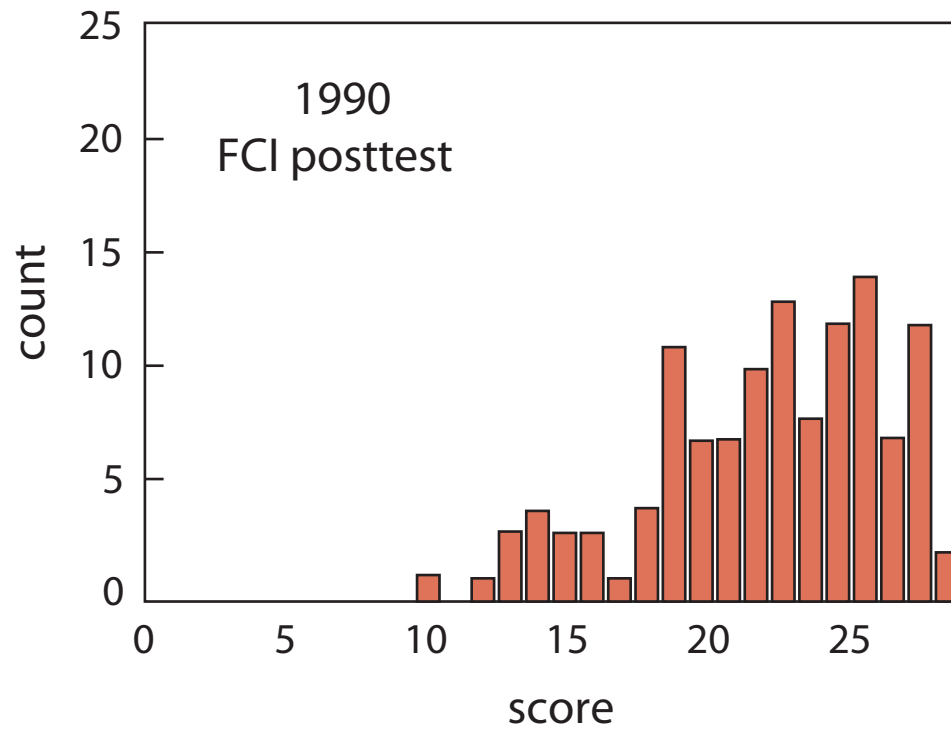

# Education

education is not just information transfer

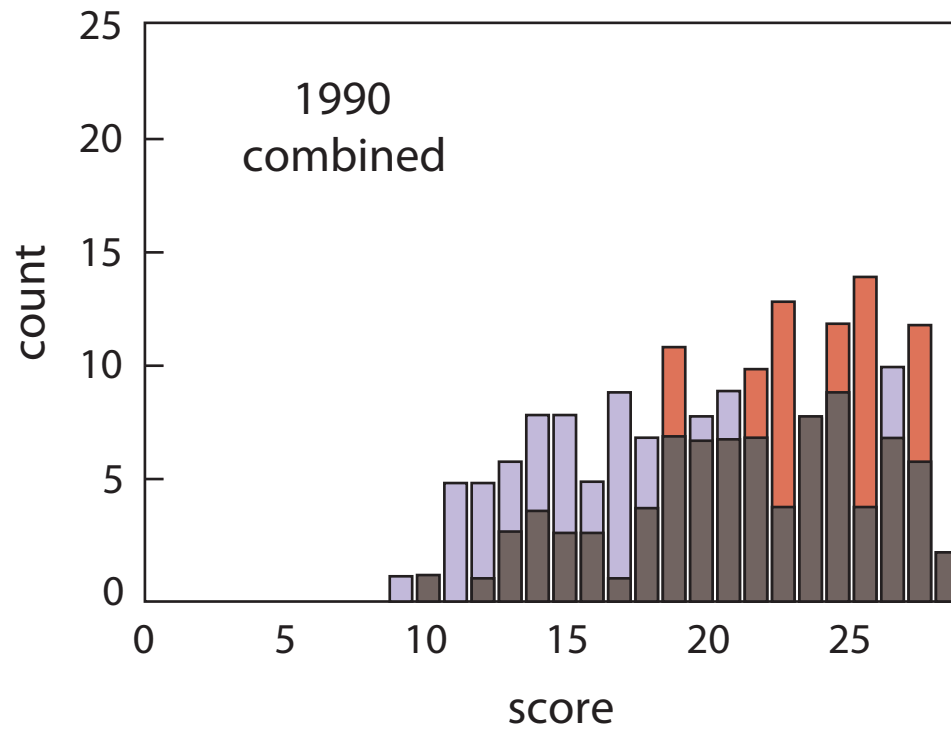

# Education

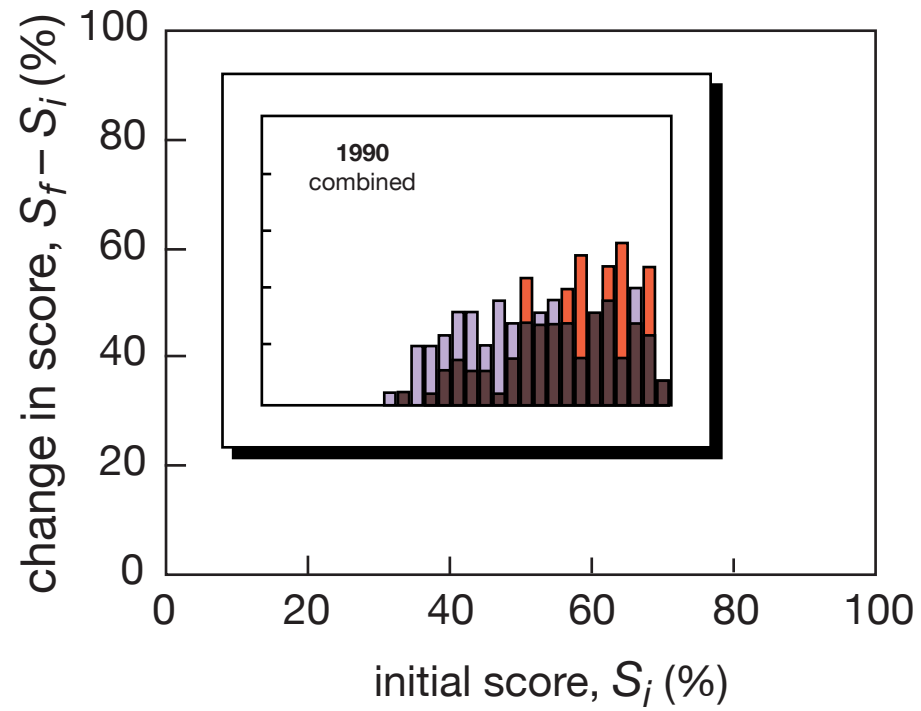

# Education

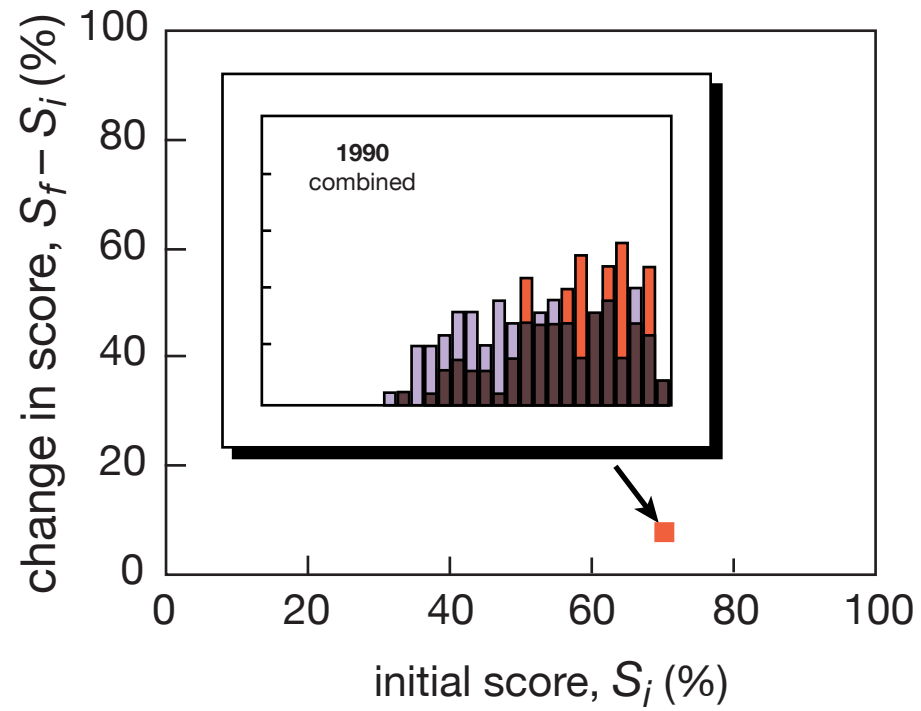



# Education

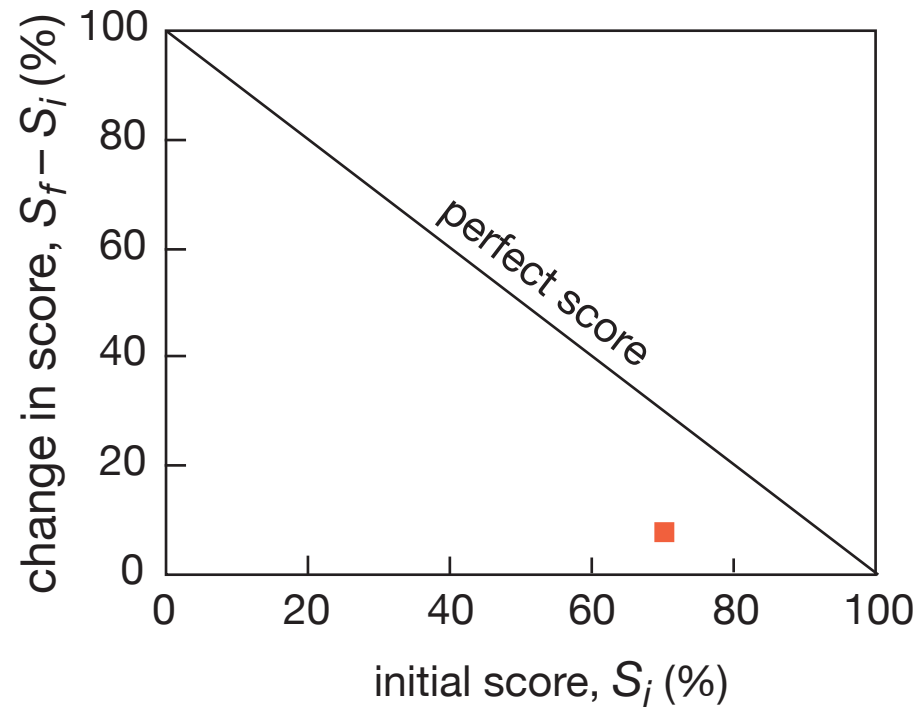

# Education

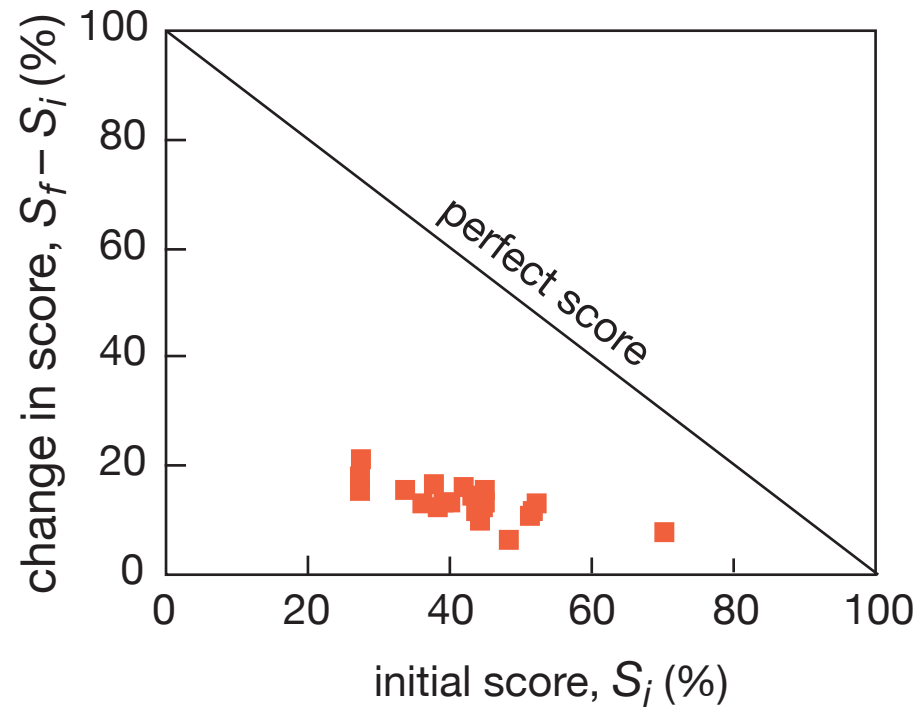

# Education

only one quarter of maximum gain realized

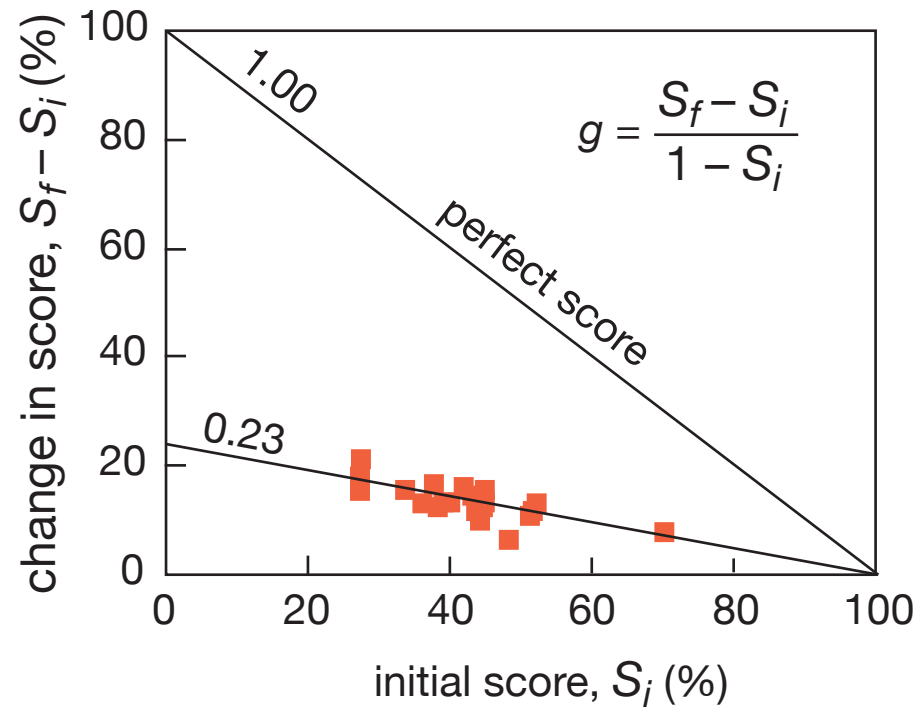

# Education

**not transfer but assimilation of information is key**

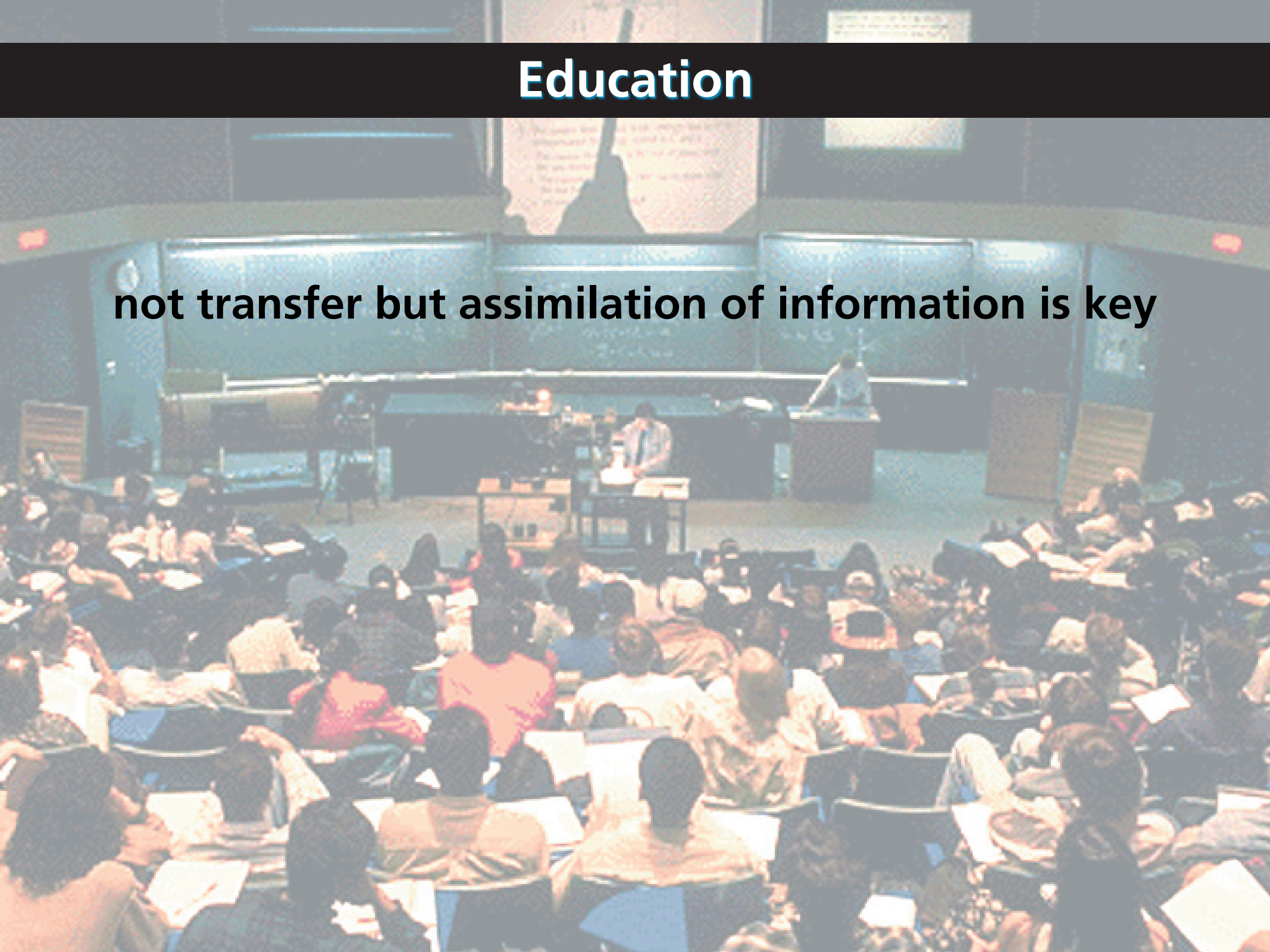



# Education

conventional problems misleading

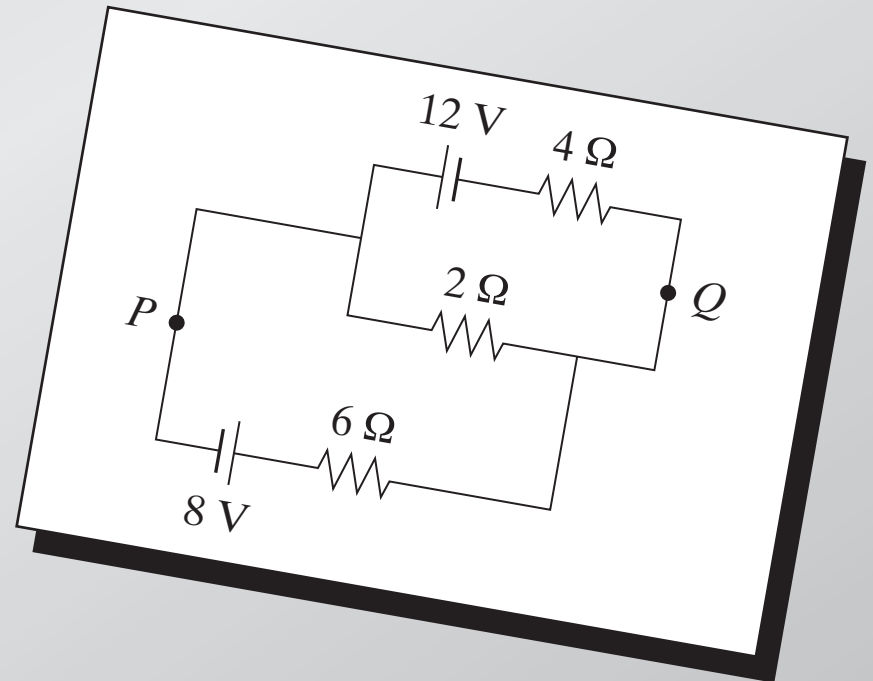

# Education

conventional problems misleading

Calculate:

(a) current in  $2\text{-}\Omega$  resistor

(b) potential difference

between  $P$  and  $Q$

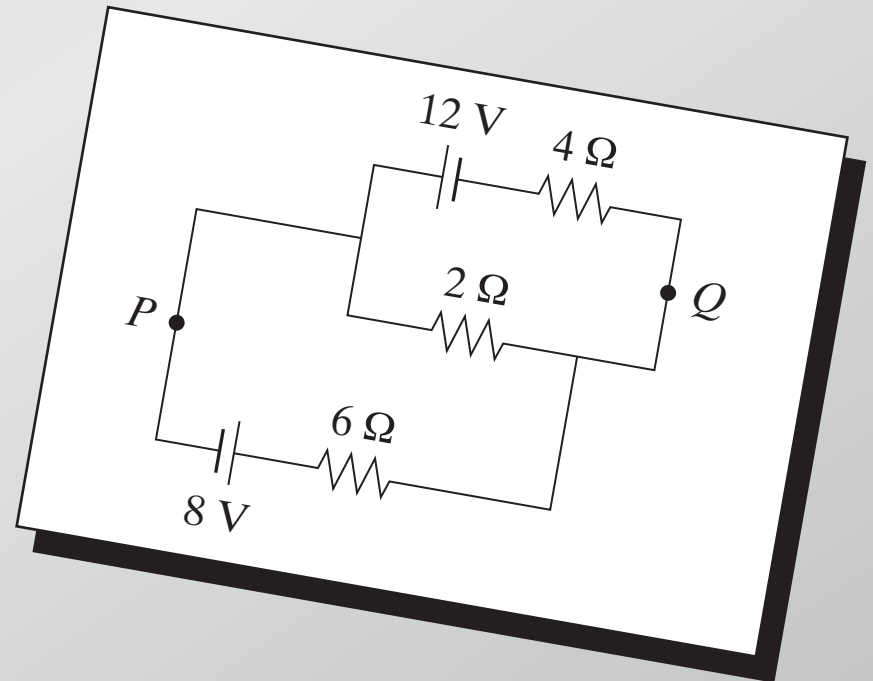

# Education

are the basic principles understood?

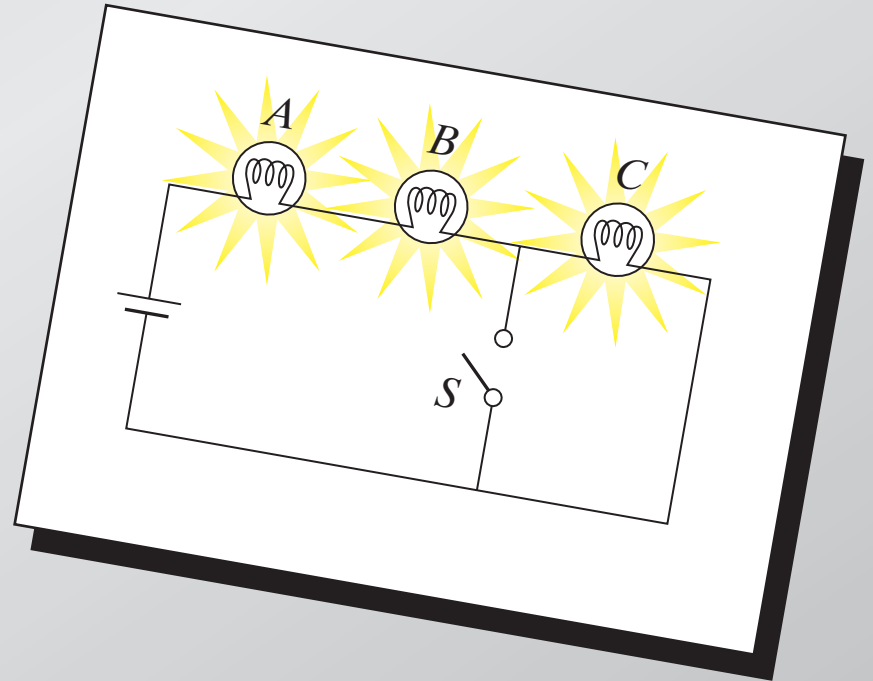

# Education

are the basic principles understood?

When  $S$  is closed, what happens to:

- (a) intensities of  $A$  and  $B$ ?
- (b) intensity of  $C$ ?
- (c) current through battery?
- (d) potential difference across  
 $A$ ,  $B$ , and  $C$ ?
- (e) the total power dissipated?

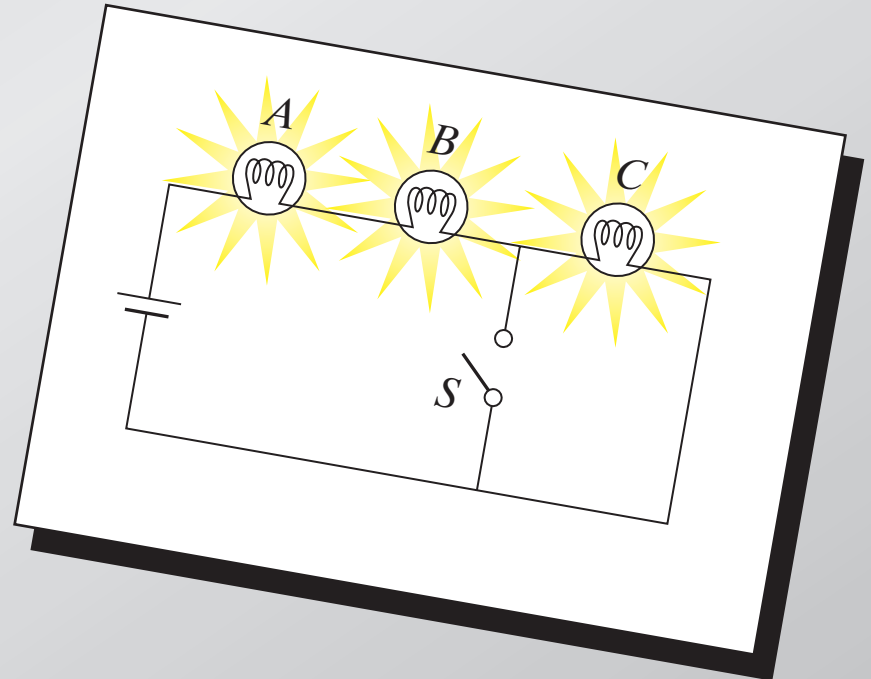



# Education

## conventional

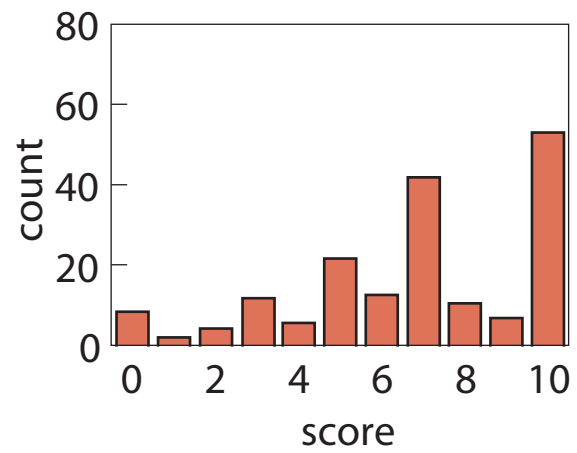

## conceptual

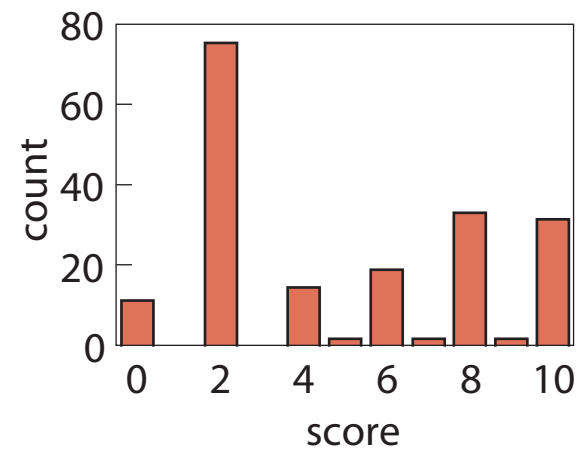

# Education

## conventional

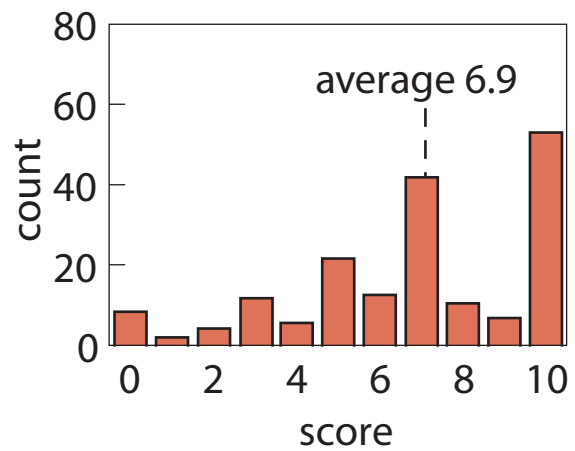

## conceptual

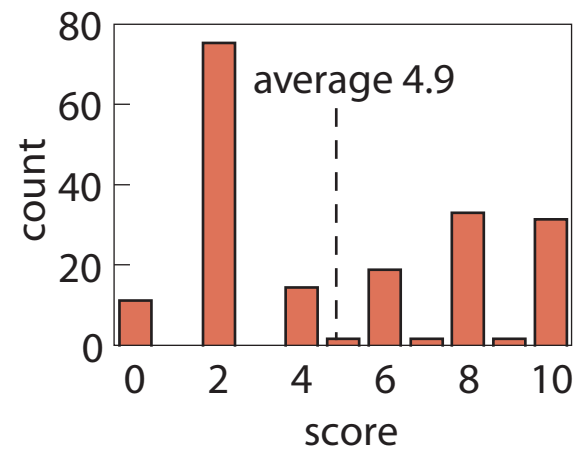

# Education

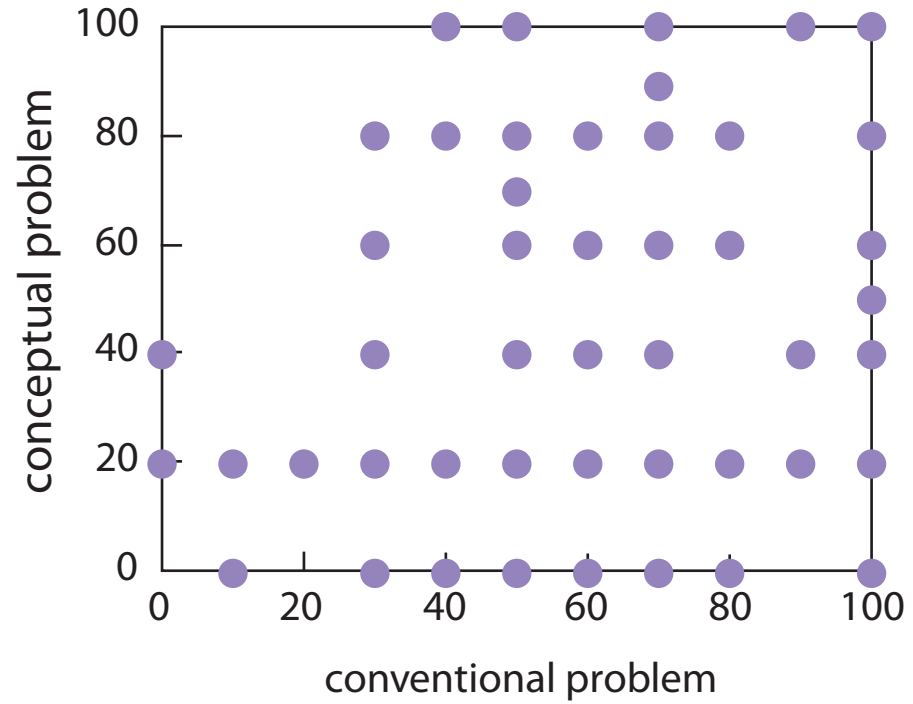





A large lecture hall with students seated at desks, facing a stage with a lecturer and a large screen displaying text. The text on the screen is partially legible and appears to be a list of items or a document. The room is dimly lit, with the stage area being the primary light source. The students are mostly seen from behind, looking towards the front of the room. The lecturer is standing at a podium on the stage, facing the audience. The overall atmosphere is that of a formal academic setting.

So what should we do?

# Peer Instruction

**Give students more responsibility for gathering information...**

# Peer Instruction

**Give students more responsibility for gathering information...  
so we can better help them assimilate it.**

# Peer Instruction

## Main features:

- pre-class reading
- in-class: depth, not 'coverage'
- ConcepTests

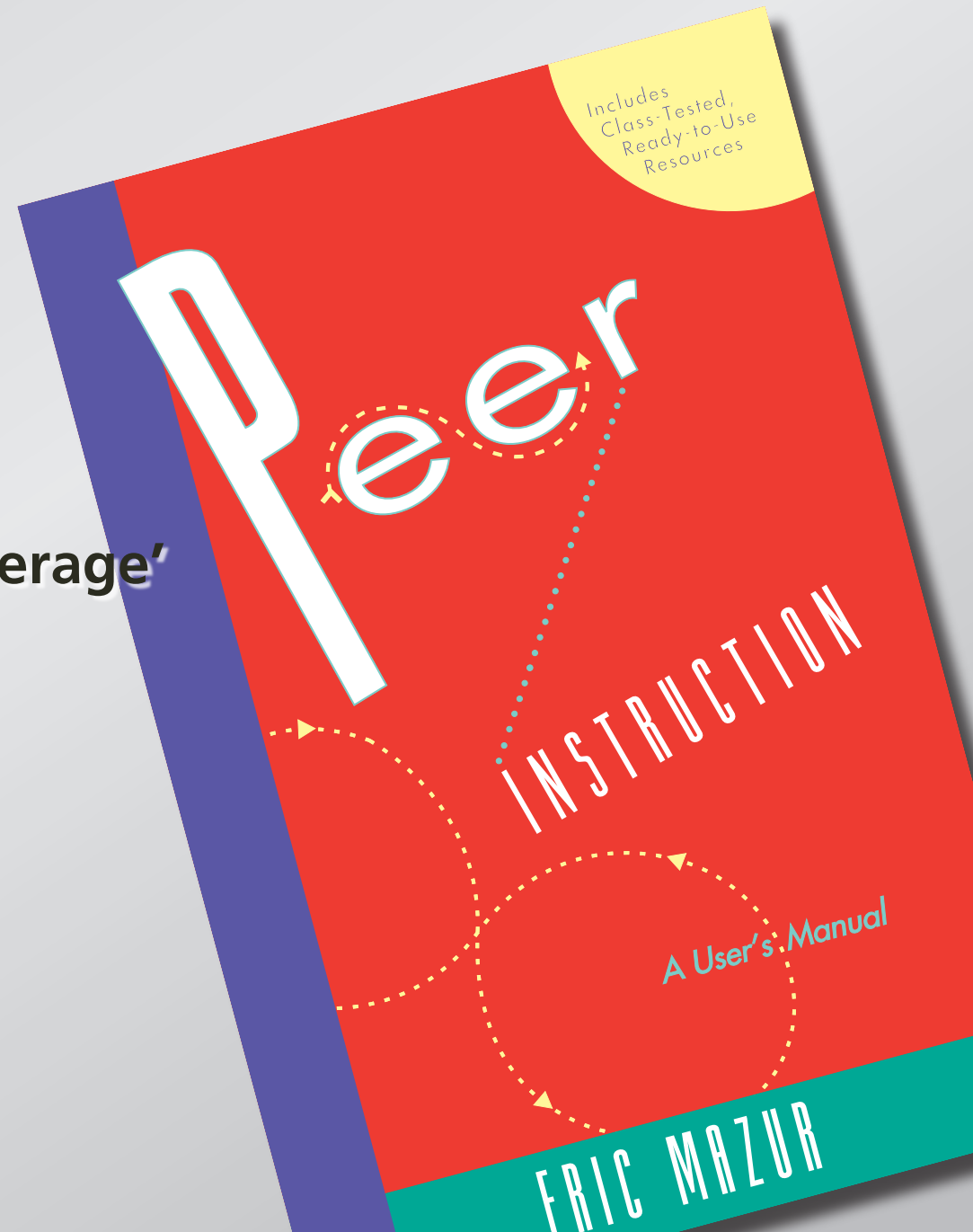

# Peer Instruction

**ConcepTest:**

- 1. Question**
- 2. Thinking**
- 3. Individual answer**
- 4. Peer discussion**
- 5. Revised/Group answer**
- 6. Explanation**





# Results

**is it any good?**

# Results

## first year of implementing PI

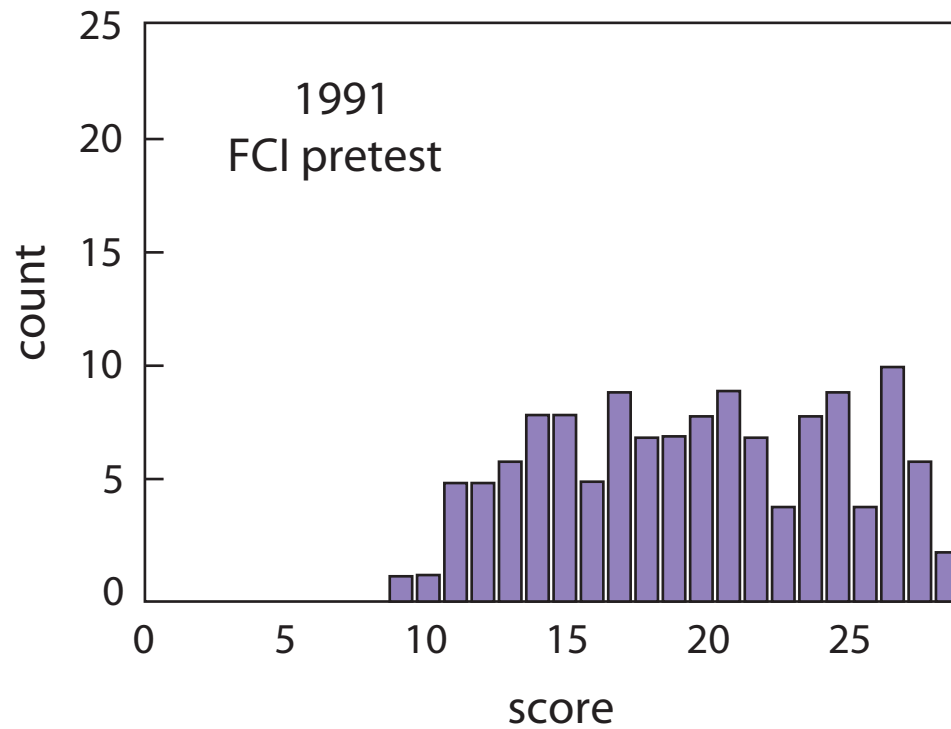

# Results

## first year of implementing PI

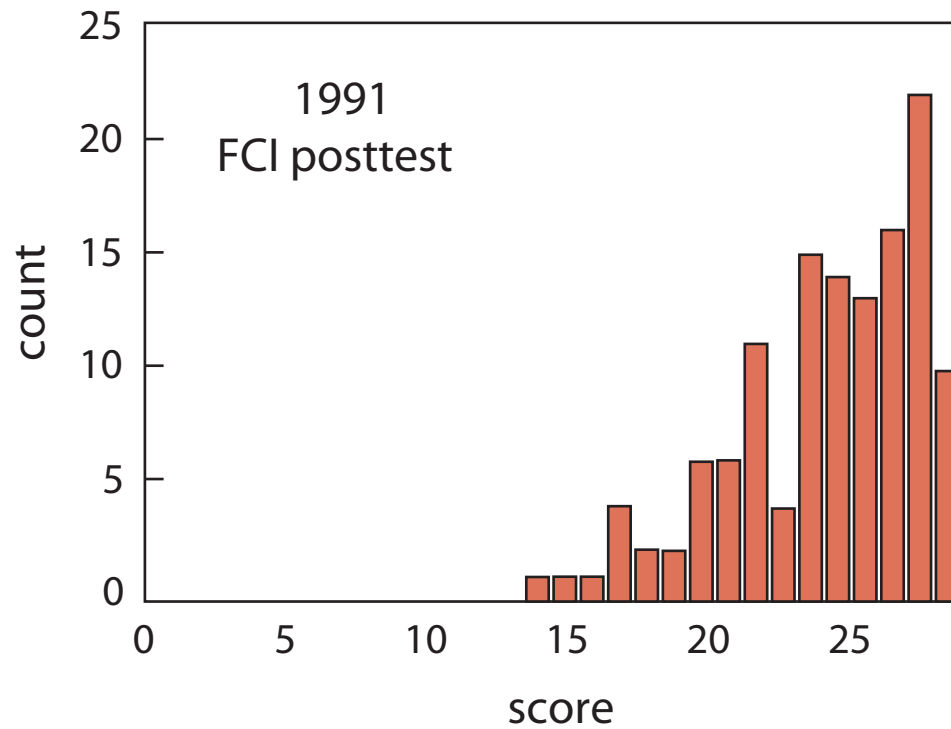

# Results

## first year of implementing PI

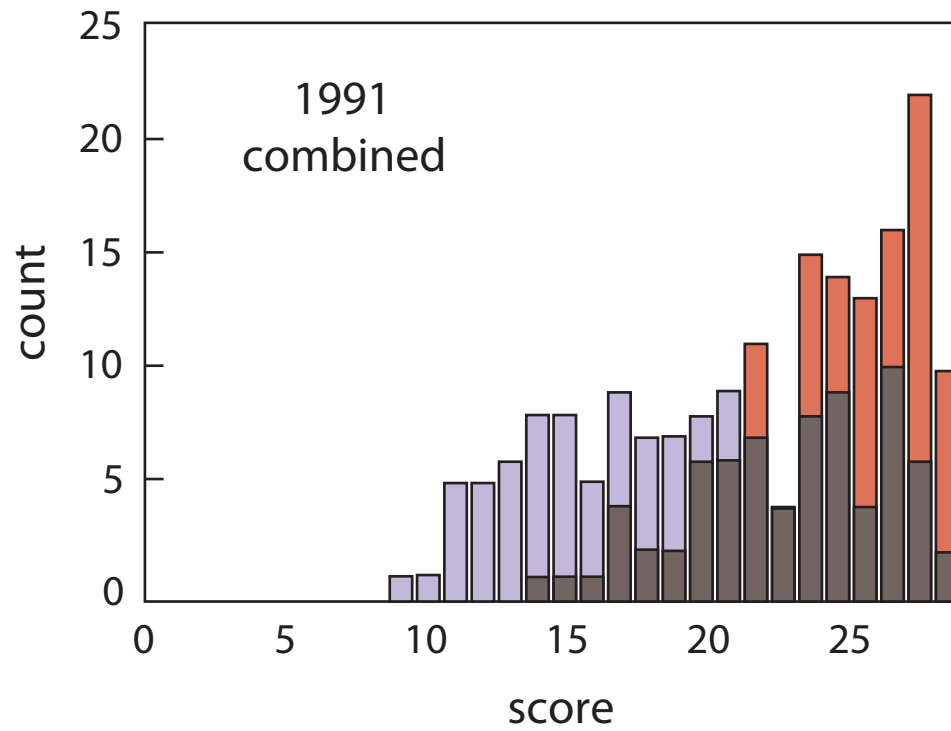

# Results

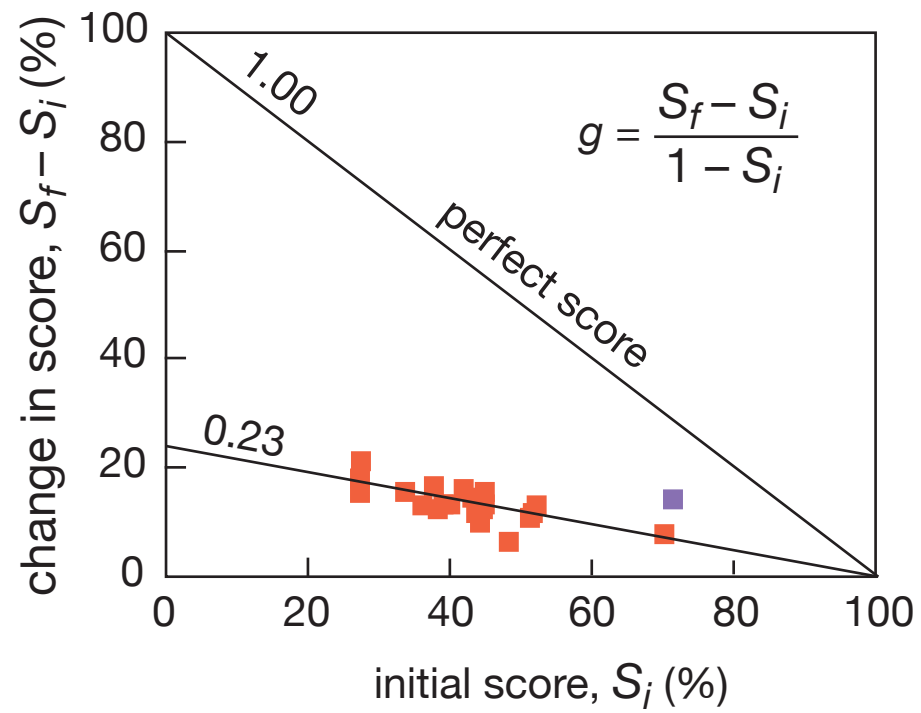

# Results

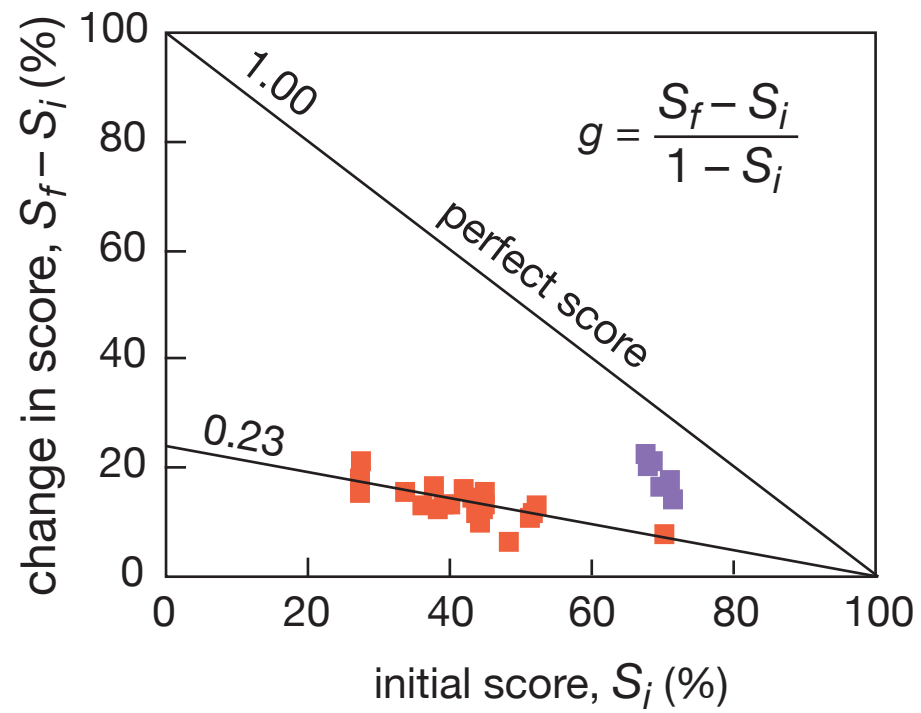

# Results

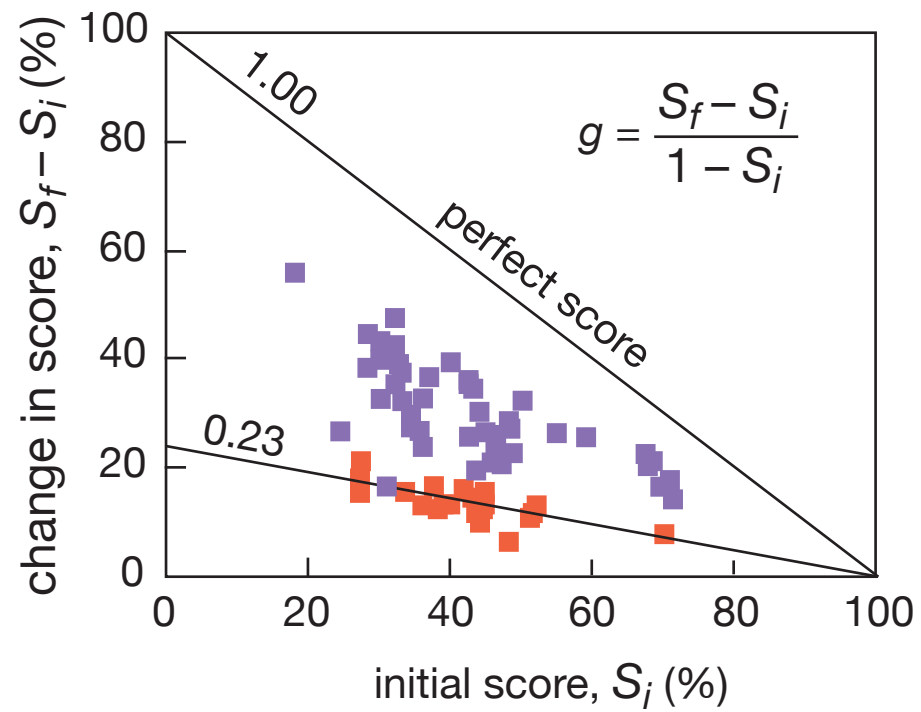



# Results

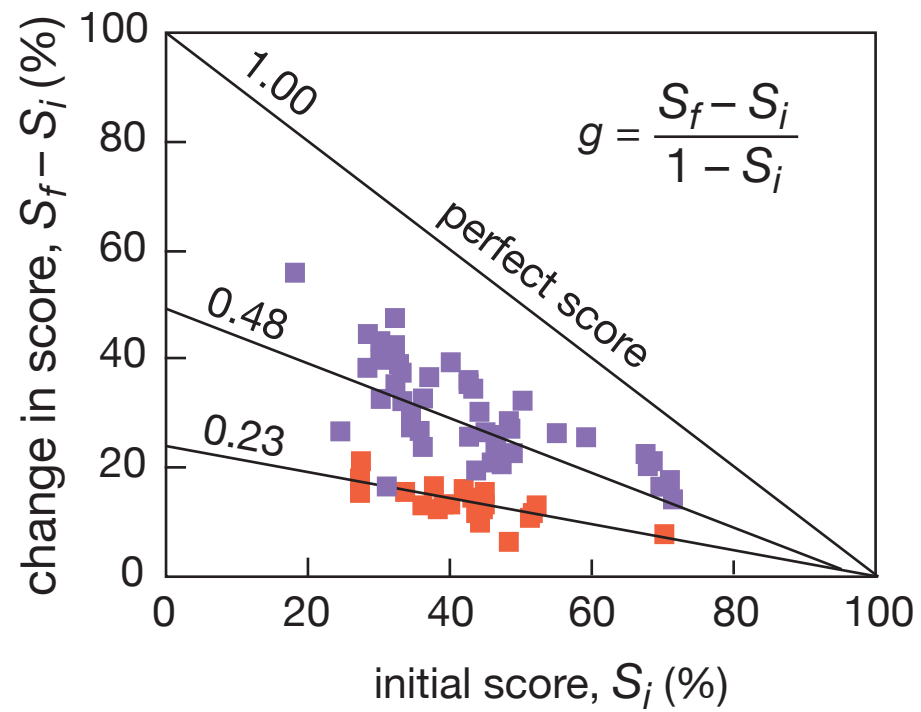

# Results

**what about problem solving?**

# Results

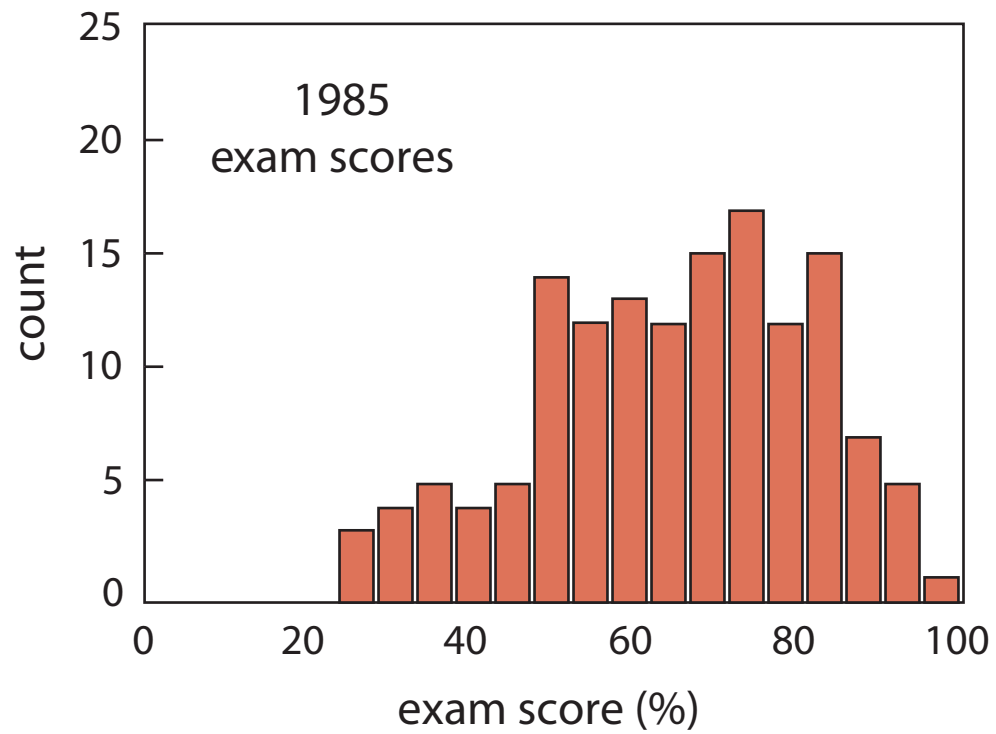

# Results

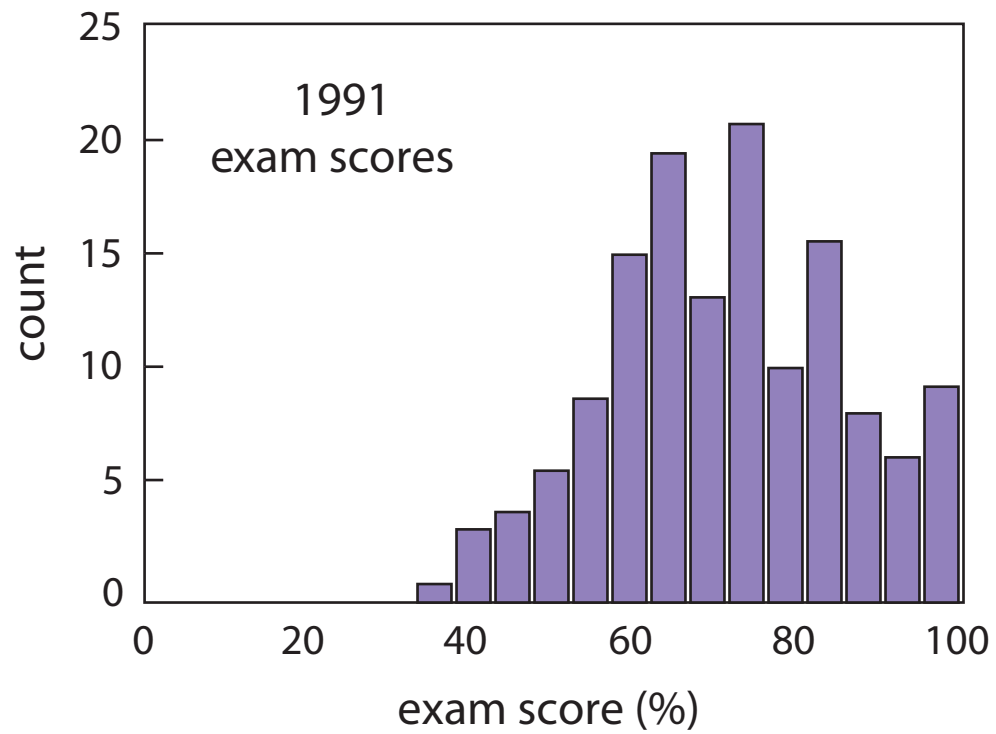

# Results

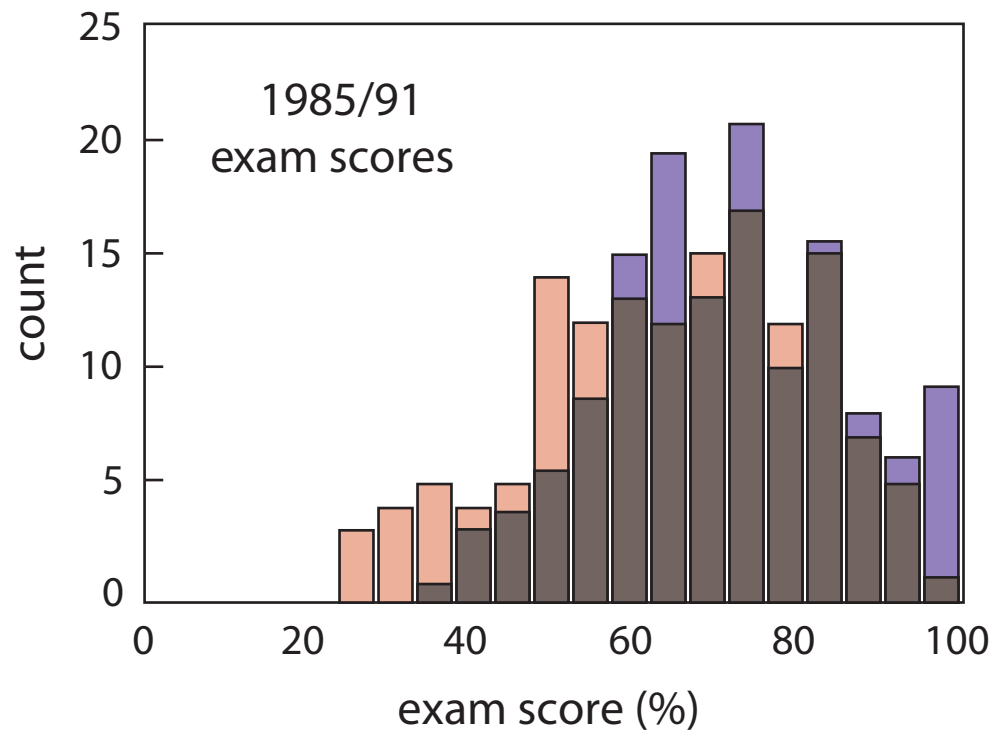

# Summary

**So better understanding leads to better  
problem solving!**

# Summary

**So better understanding leads to better problem solving!**

**(but “good” problem solving doesn’t always indicate understanding!)**





# Summary

**Traditional indicators of success misleading**

# Summary

**Traditional indicators of success misleading**

**Education is no longer about information**

**Funding:**

**National Science Foundation**

**for a copy of this presentation:**

**<http://mazur-www.harvard.edu>**

**[http://twitter.com/eric\\_mazur](http://twitter.com/eric_mazur)**

Google™

Google Search

I'm Feeling Lucky

Google™

mazur

Google Search

I'm Feeling Lucky

Google™

mazur

Google Search

I'm Feeling Lucky

# Google™

Google Search

I'm Feeling Lucky



**Funding:**

**National Science Foundation**

**for a copy of this presentation:**

**<http://mazur-www.harvard.edu>**

**[http://twitter.com/eric\\_mazur](http://twitter.com/eric_mazur)**