

Femtosecond laser micromachining

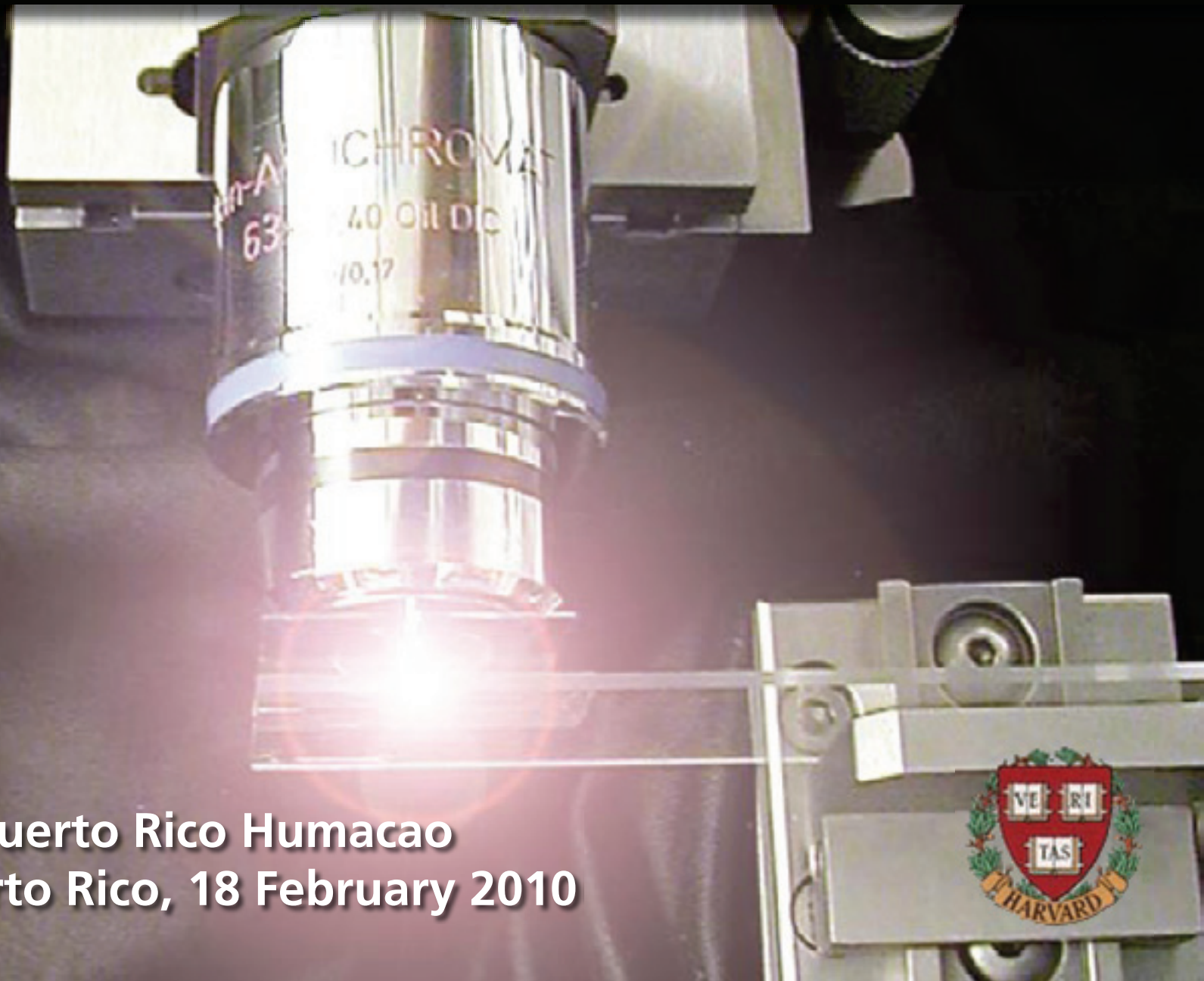

University of Puerto Rico Humacao
Humacao, Puerto Rico, 18 February 2010



Rafael Gattass



Loren Cerami



Tina Shih

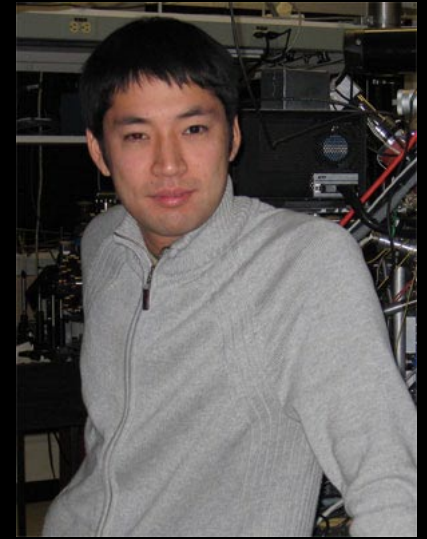

Masanao Kamata

and also....

Iva Maxwell

San Chung

Eli Glezer

Chris Schaffer

Nozomi Nishimura

Jonathan Ashcom

Jeremy Hwang

Nan Shen

Dr. André Brodeur

Dr. Sanjoy Kumar

Dr. Limin Tong

Dr. Prissana Thamboon

Prof. Igor Khruschev (Aston University)

Prof. Denise Krol (UC Davis)

Dr. Yossi Chay (Sagitta, Inc.)

Dr. S.K. Sundaram (PNNL)

Prof. Minoru Obara (Keio University)

Prof. Don Ingber (Harvard Medical School)

Prof. Aravi Samuel (Harvard)

My message

fs micromachining: great technique for manipulating matter

Introduction

DAMAGED



STP 1141

22nd ANNUAL BOULDER DAMAGE SYMPOSIUM
Proceedings



LASER-INDUCED DAMAGE
IN OPTICAL MATERIALS: 1990

24-26 OCTOBER 1990
BOULDER, COLORADO

Introduction

216

J. Opt. Soc. Am. B/Vol. 13, No. 1/January 1996

Breakdown threshold and plasma formation in femtosecond laser–solid interaction

D. von der Linde and H. Schüler

Institut für Laser- und Plasmaphysik, Universität Essen, D-45117 Essen, Germany

Received March 6, 1995; revised manuscript received June 15, 1995

Combining femtosecond pump–probe techniques with optical microscopy, we have studied laser-induced optical breakdown in optically transparent solids with high temporal and spatial resolution. The threshold of plasma formation has been determined from measurements of the changes of the optical reflectivity associated with the developing plasma. It is shown that plasma generation occurs at the surface. We have observed a remarkable resistance to optical breakdown and material damage in the interaction of femtosecond laser pulses with bulk optical materials. © 1996 Optical Society of America

1. INTRODUCTION

The interaction of intense femtosecond laser pulses with solids offers the possibility of producing a new class of plasmas having approximately solid-state density and spatial density scale lengths much smaller than the wavelength of light. These high-density plasmas with extremely sharp density gradients are currently of great interest, particularly from the point of view of generating bright, ultrashort x-ray pulses. To produce such a plasma, the laser pulse should rise from the intensity level corresponding to the threshold of plasma formation to the peak value in a time much shorter than the time scale of plasma expansion. Thus the specification of the total intensity background or of the acceptable amount of plasma expansion requires some knowledge of the physical processes of the target material.

One of the key points in the research of Bloembergen and his co-workers was the use of very tightly focused laser beams, which allowed them to reach the breakdown threshold of the materials while staying well below the critical power of self-focusing. Self-focusing is one of the major problems in the measurement of bulk breakdown thresholds. In a more recent review Soileau *et al.*⁵ carefully examined the role of self-focusing in experiments measuring laser-induced breakdown of bulk dielectric materials. They concluded that the breakdown and damage thresholds are also strongly influenced by extrinsic effects.

Thus far, the issue of breakdown thresholds in femtosecond laser–solid interaction has barely been touched. Very recently, Du *et al.*⁶ carried out laser-induced breakdown experiments on fused silica with pulses ranging in duration from 7 ns to as low as 150 fs. They reported an interesting dependence of the fluence threshold on pulse duration, particularly a pronounced increase of the threshold with decreasing pulse duration below 10 ps. These observations were interpreted in terms of the Stuart–Miles model. In related research, Stuart and co-workers⁷ reported a width dependence of the breakdown threshold of materials and a peak variation

D. von der Linde and H. Schüler

Introduction

216

J. Opt. Soc. Am. B/Vol. 13, No. 1/January 1996

D. von der Linde and H. Schüler

"... clear evidence that no bulk plasmas...

[and] ... no bulk damage could be produced

with femtosecond laser pulses"

1. INTRODUCTION

The interaction of intense femtosecond laser pulses with solids offers the possibility of producing a new class of plasmas having approximately solid-state density and spatial density scale lengths much smaller than the wavelength of light. These high-density plasmas with extremely sharp density gradients are currently of great interest, particularly from the point of view of generating short x-ray pulses. To produce such a plasma, the laser pulse must rise from the intensity level corresponding to the threshold of plasma formation to the peak value in a time much shorter than the characteristic plasma expansion. Thus the specification of the intensity background or of the acceptable amount of plasma expansion requires some knowledge of the target material.

One of the key points in the research of Bloembergen and his co-workers was the use of very tightly focused laser beams, which allowed them to reach the breakdown threshold of the materials while staying well below the critical power of self-focusing. Self-focusing is one of the major problems in the measurement of bulk breakdown thresholds. In a more recent review Soileau *et al.*⁵ carefully examined the role of self-focusing in experiments measuring laser-induced breakdown of bulk dielectric materials. They concluded that the breakdown and damage thresholds are also strongly influenced by extrinsic effects.

Thus far, the issue of breakdown thresholds in femtosecond laser-solid interaction has barely been touched. Very recently, Du *et al.*⁶ carried out laser-induced breakdown experiments on fused silica with pulses ranging in duration from 7 ns to as low as 150 fs. They reported an interesting dependence of the fluence threshold on pulse duration, particularly a pronounced increase of the threshold with decreasing pulse duration below 10 ps. These observations were interpreted in terms of the breakdown model. In related research, Stuart and co-workers⁷ reported a width dependence of the threshold fluence of materials and a break varia-

von der Linde, *et al.*, J. Opt. Soc. Am. B 13, 216 (1996)

Introduction

focus laser beam inside material

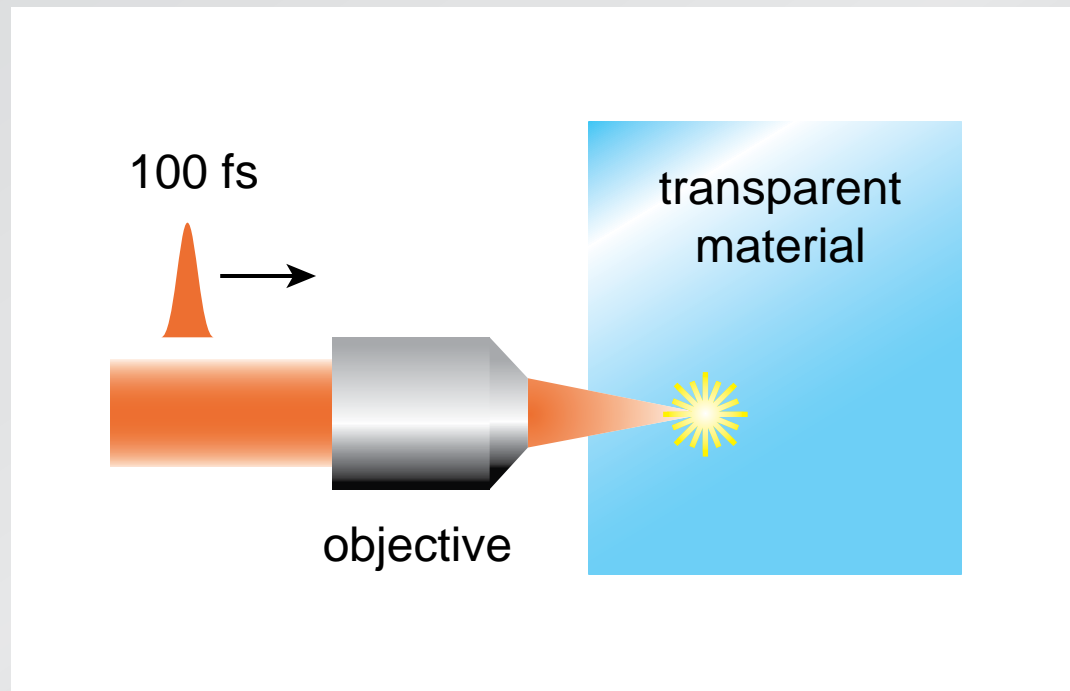

Introduction

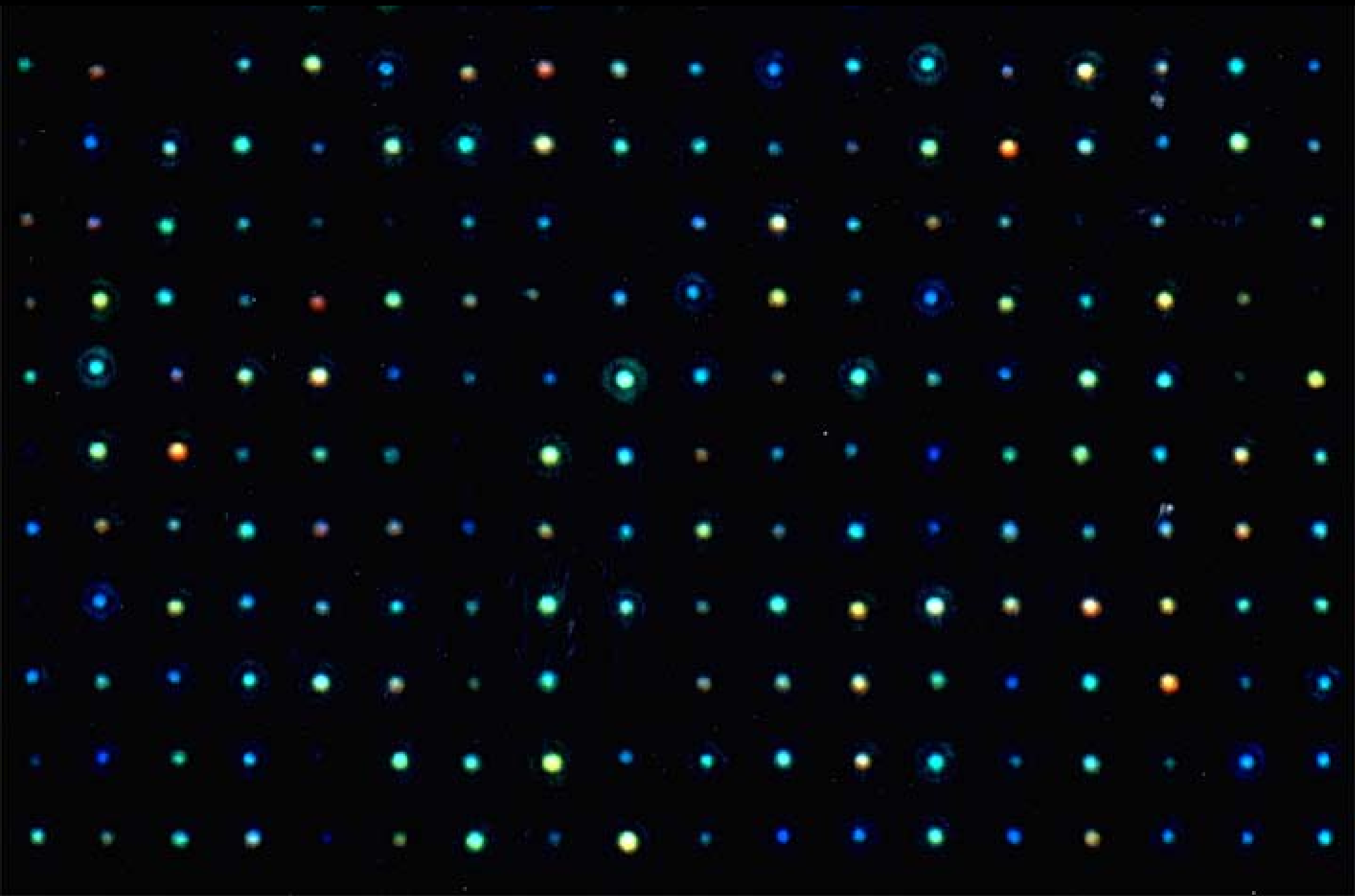

Introduction

photon energy $<$ bandgap \longrightarrow nonlinear interaction

Introduction

nonlinear interaction provides bulk confinement

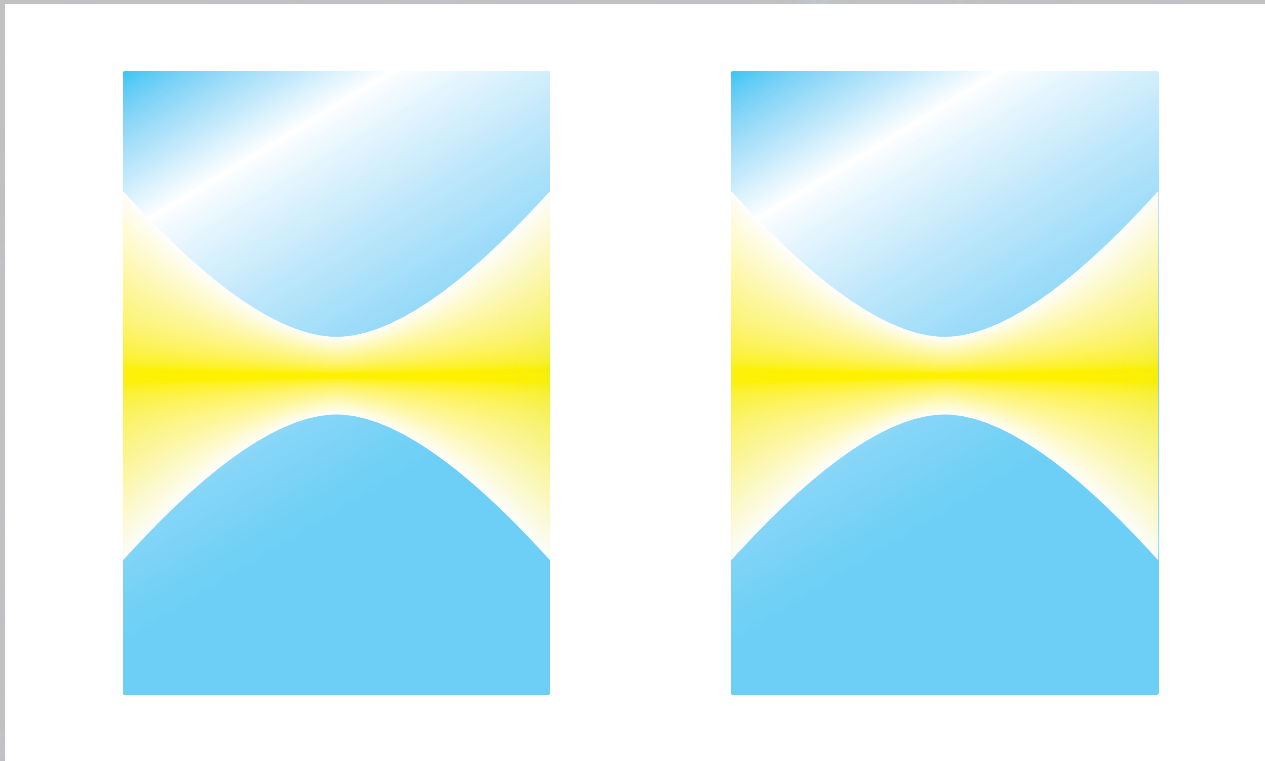

Introduction

nonlinear interaction provides bulk confinement

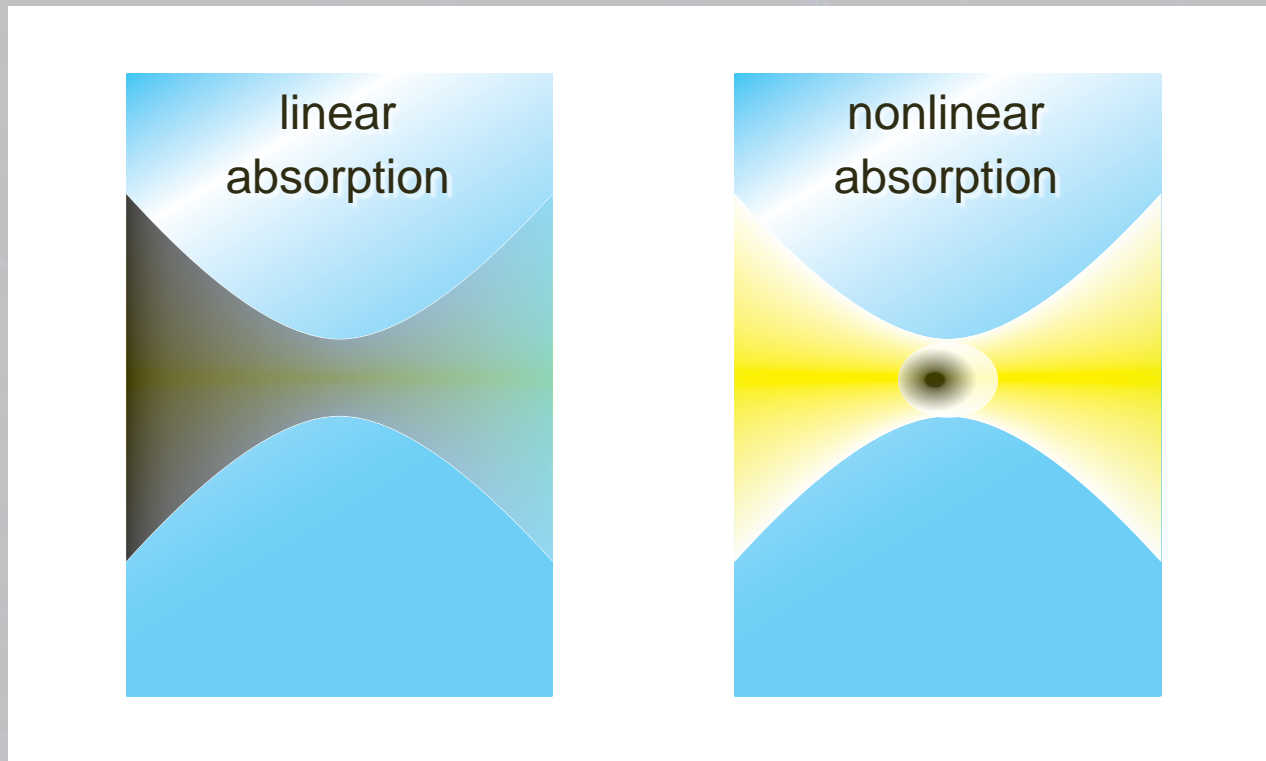

Femtosecond micromachining

Some applications:

- data storage
- waveguides
- microfluidics

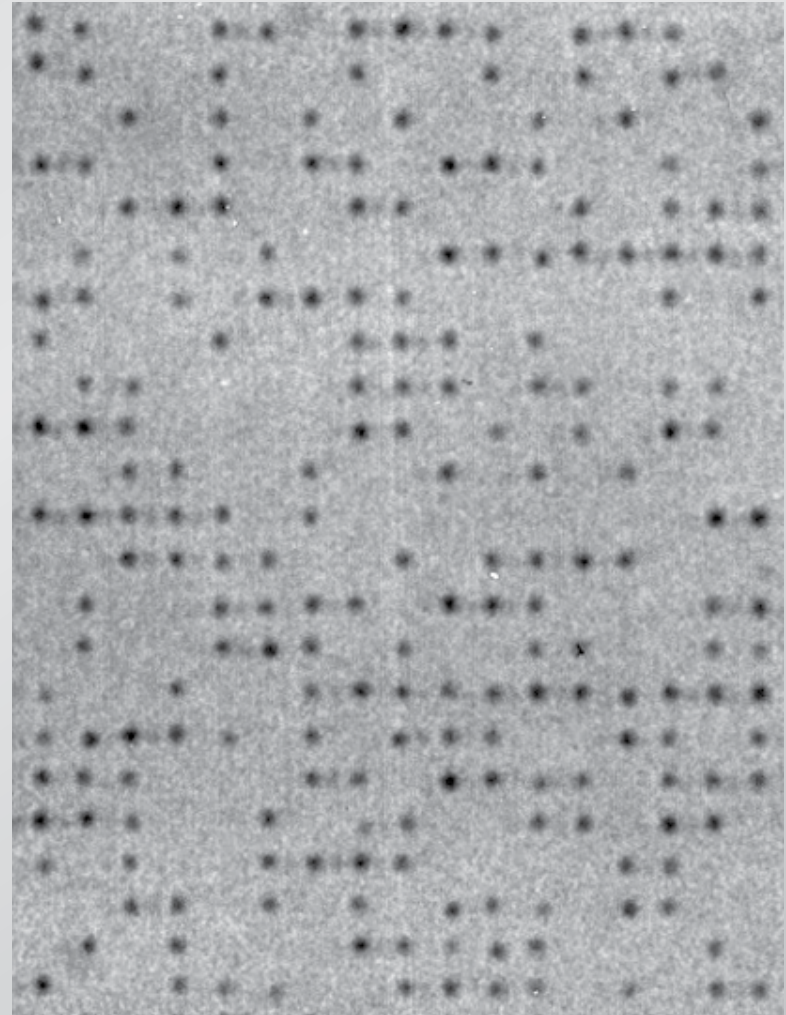

Outline

- femtosecond micromachining
- low-energy machining
- applications

Femtosecond micromachining

Dark-field scattering

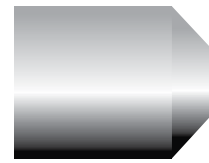

objective



sample

Femtosecond micromachining

block probe beam...

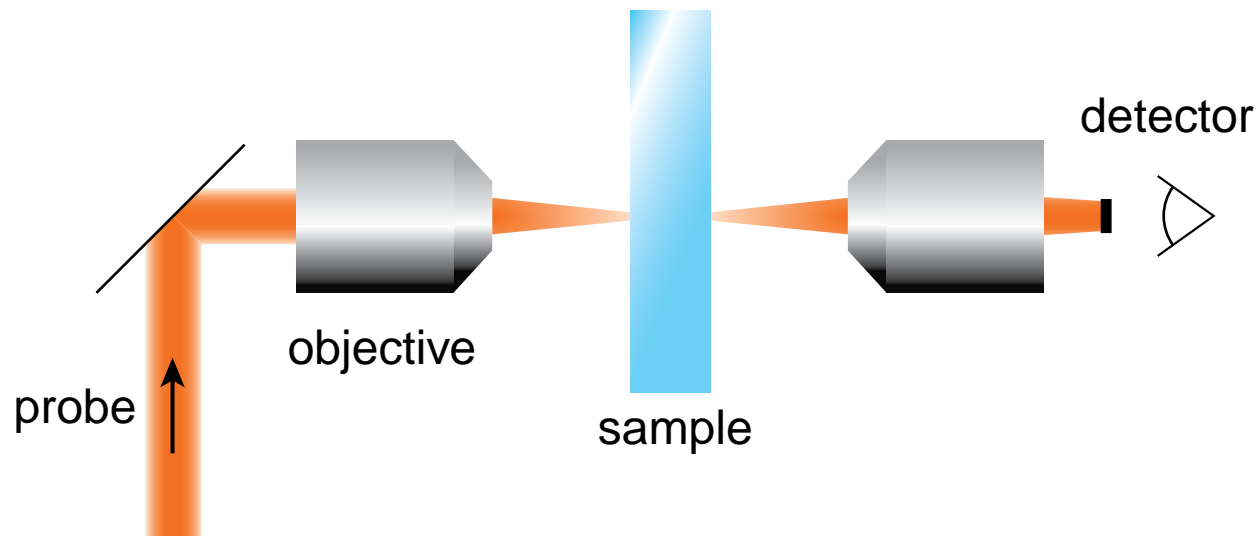

Femtosecond micromachining

... bring in pump beam...

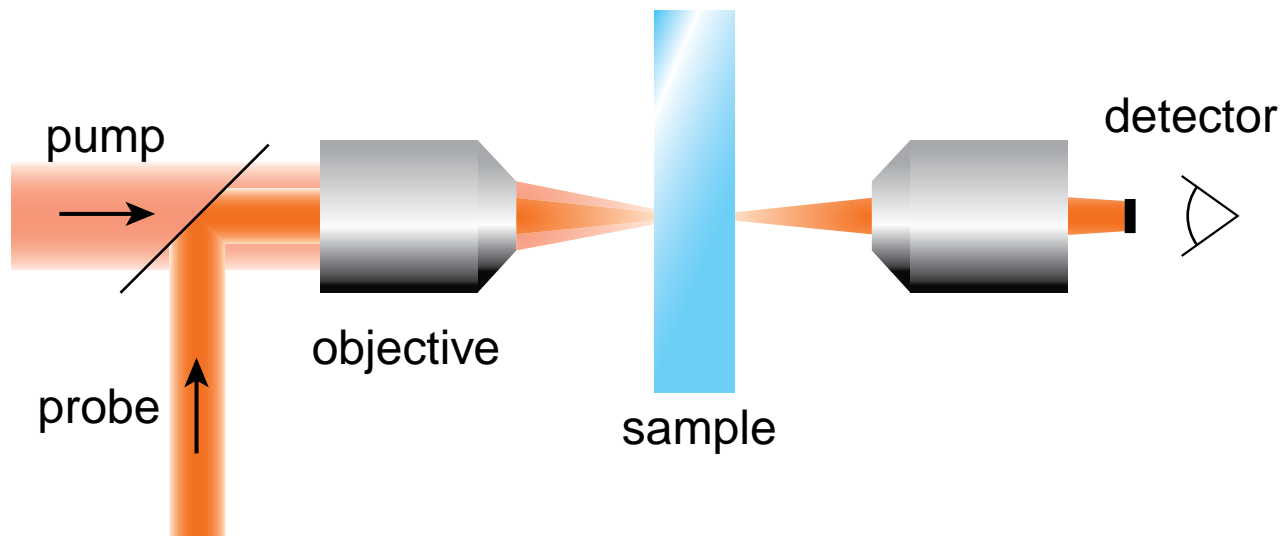

Femtosecond micromachining

... damage scatters probe beam

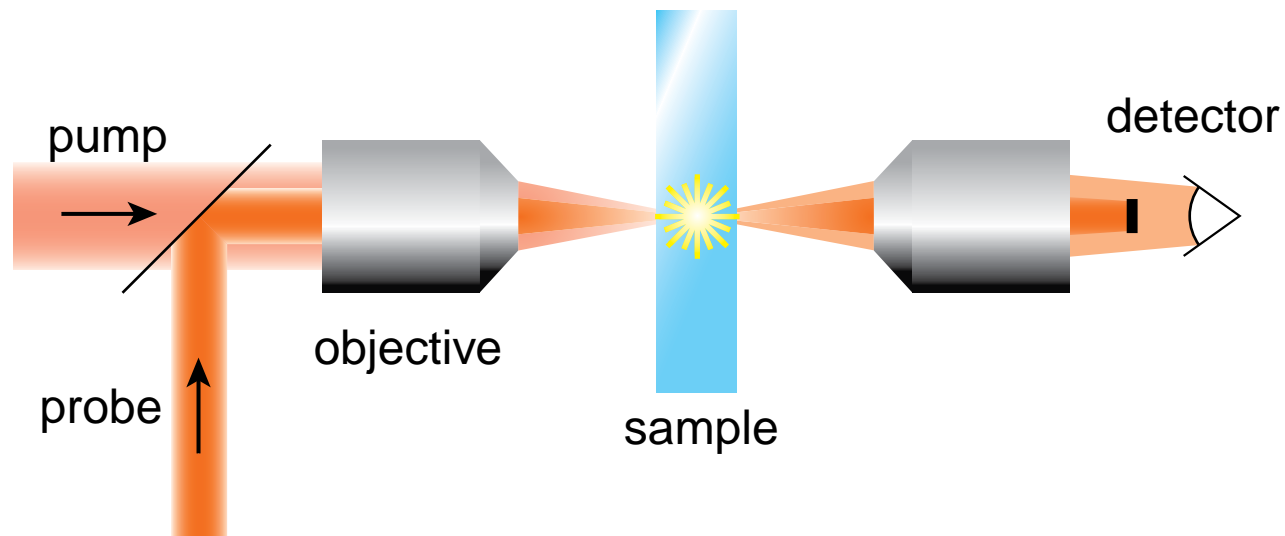

Femtosecond materials interactions

scattered signal

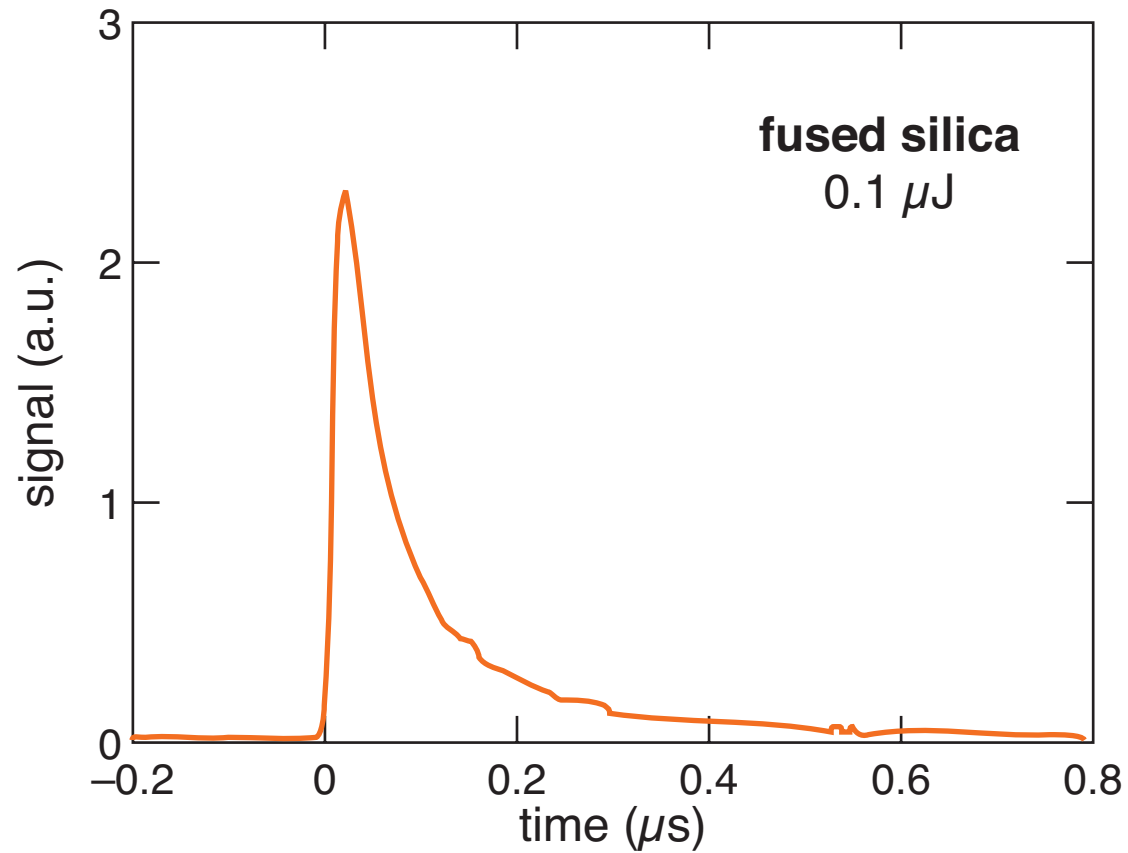

Femtosecond materials interactions

scattered signal

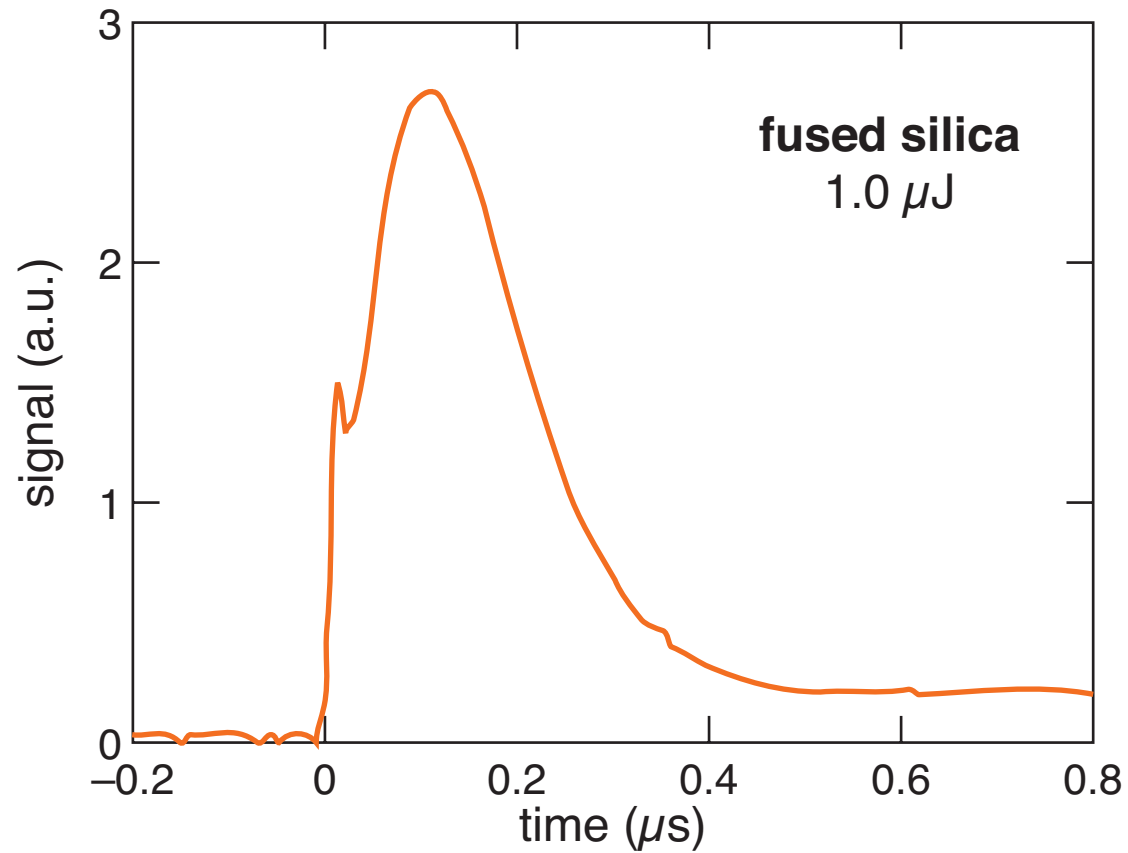

Femtosecond materials interactions

scattered signal

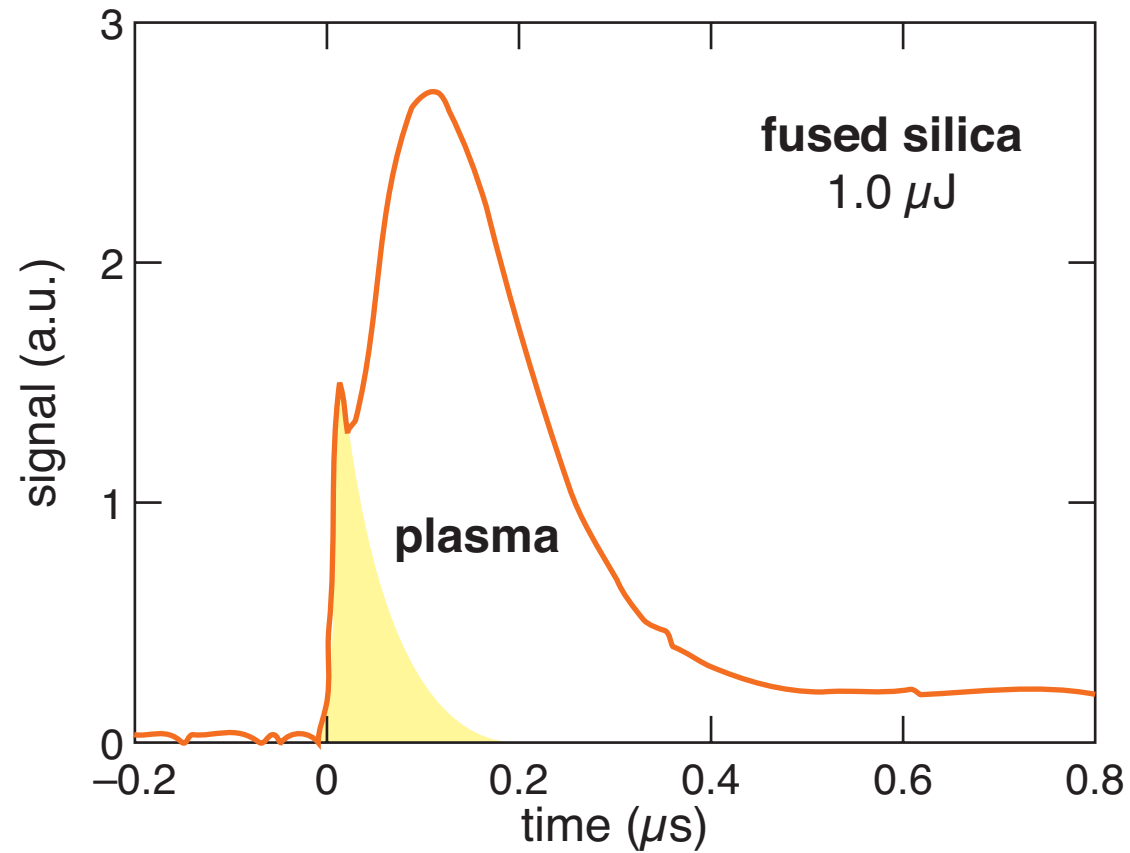

Femtosecond materials interactions

scattered signal

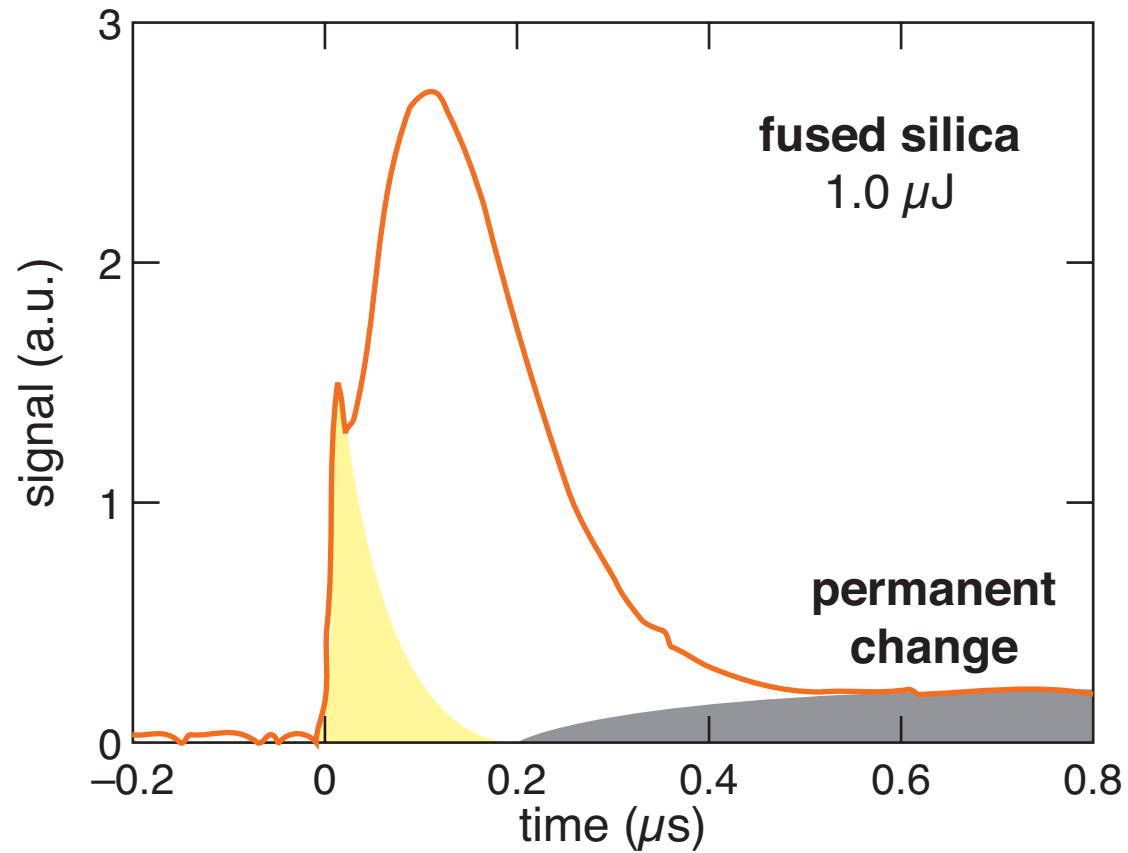

Femtosecond materials interactions

scattered signal

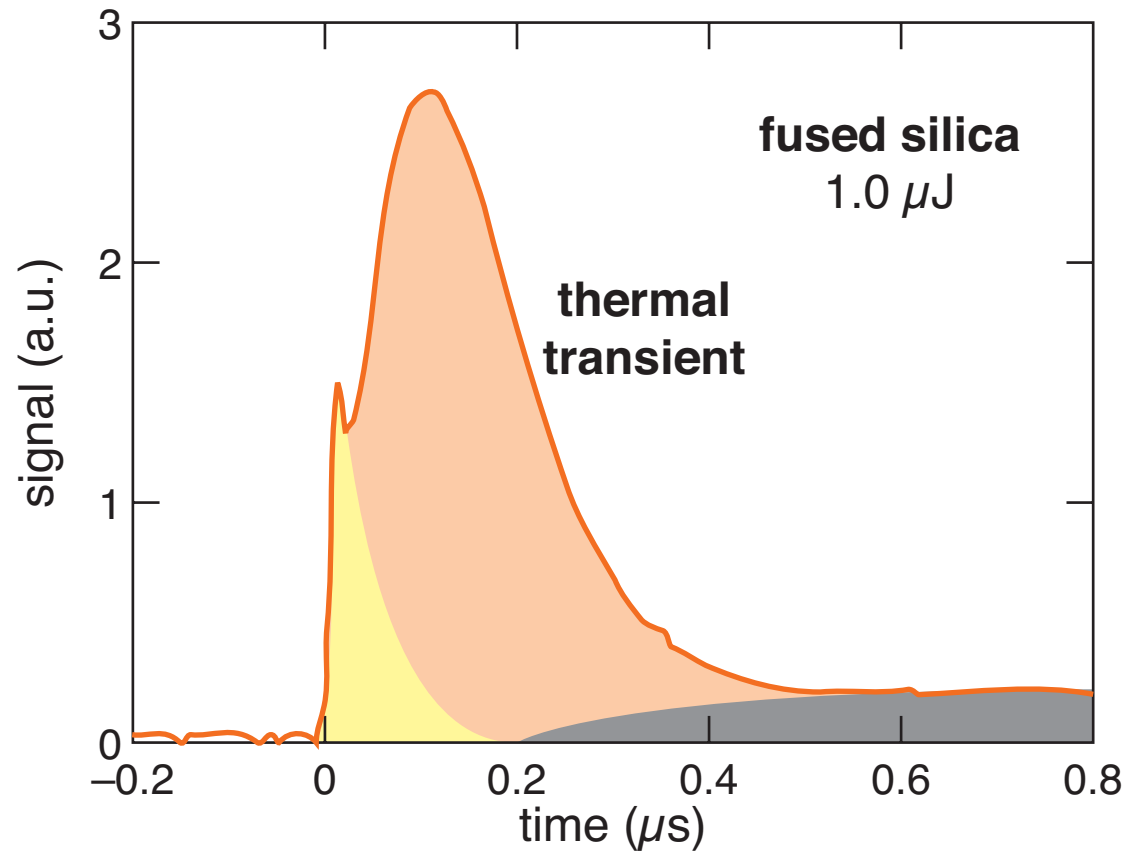

Femtosecond micromachining

vary numerical aperture

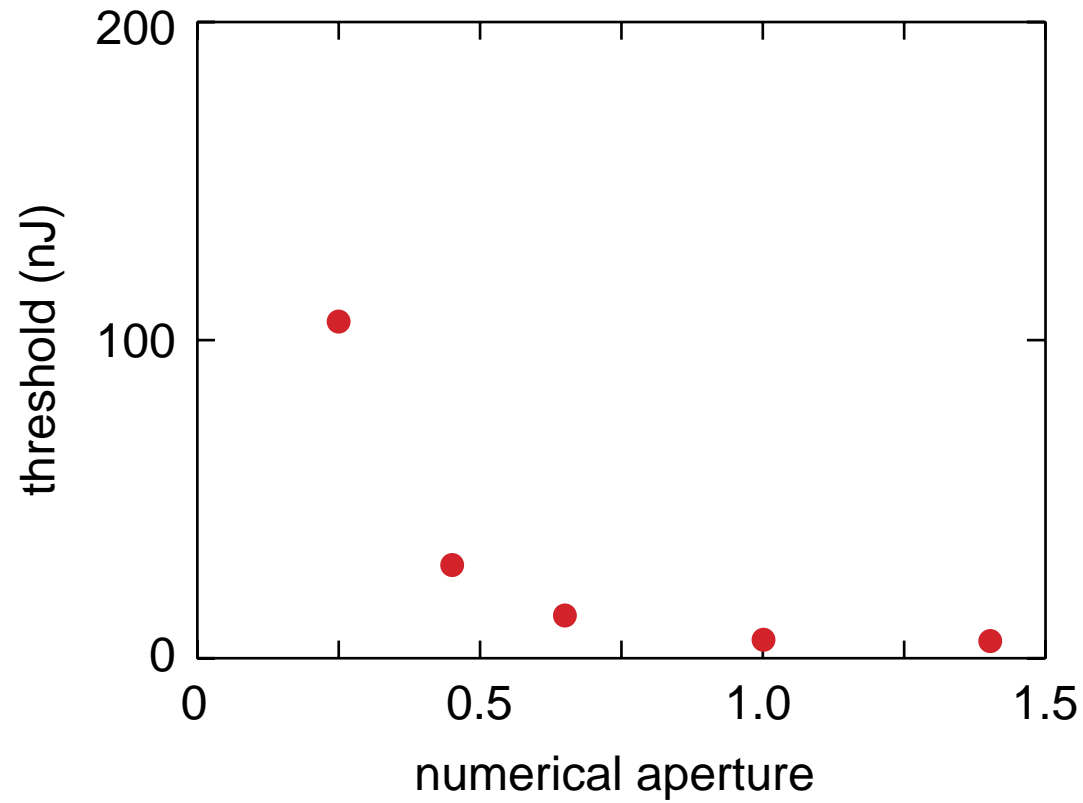

Femtosecond micromachining

vary numerical

intensity threshold:

$$E_{th} = I_{th} \tau A$$

spot size determined by
numerical aperture:

$$E_{th} = I_{th} \tau A = \frac{I_{th} \tau \lambda^2}{\pi (\text{NA})^2}$$

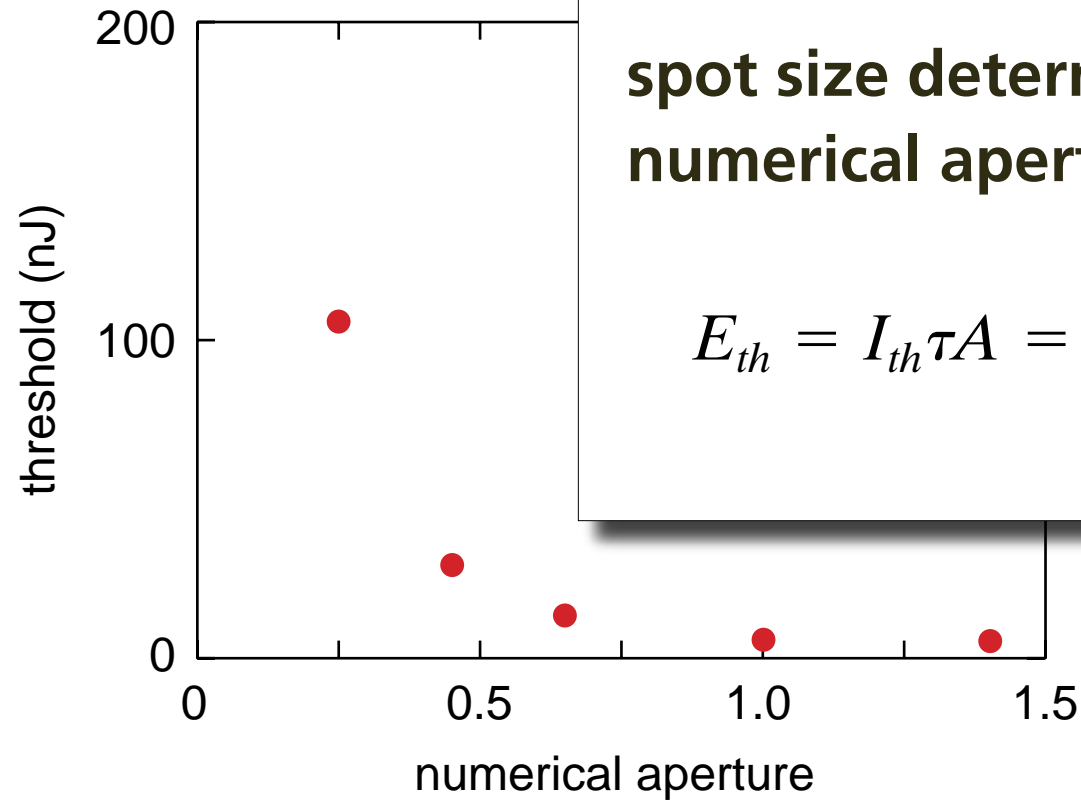

Femtosecond micromachining

fit gives threshold intensity: $I_{th} = 2.5 \times 10^{17} \text{ W/m}^2$

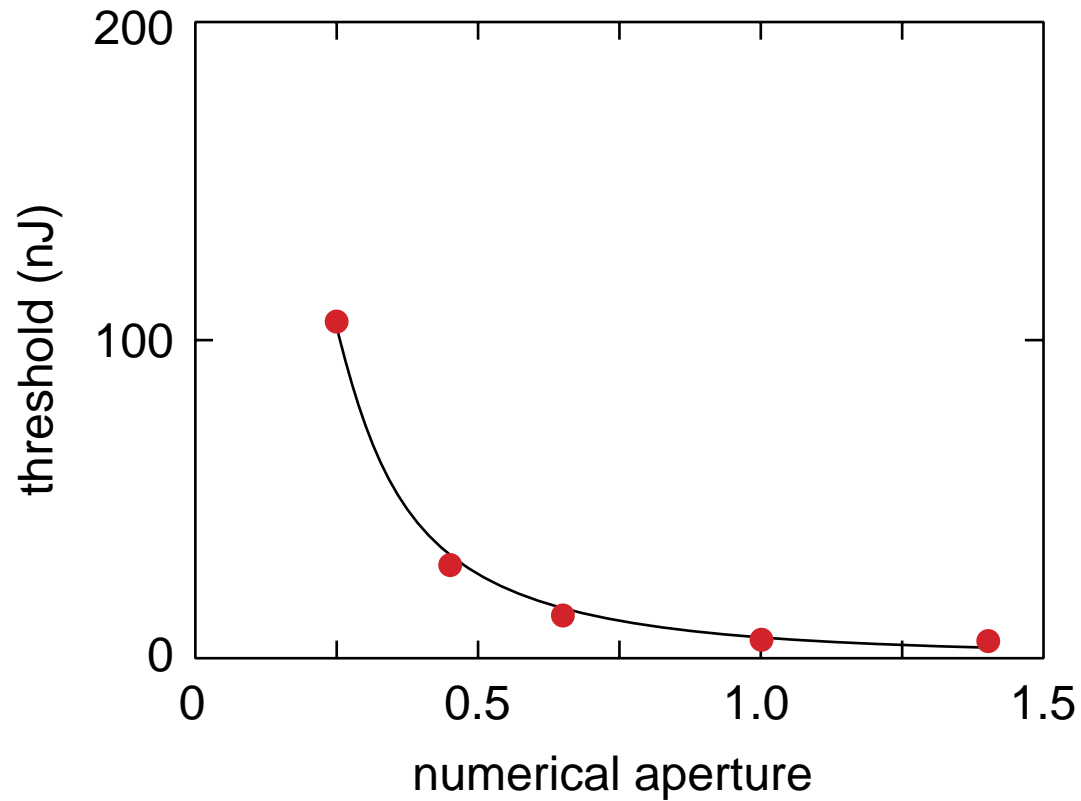

Femtosecond micromachining

vary material...

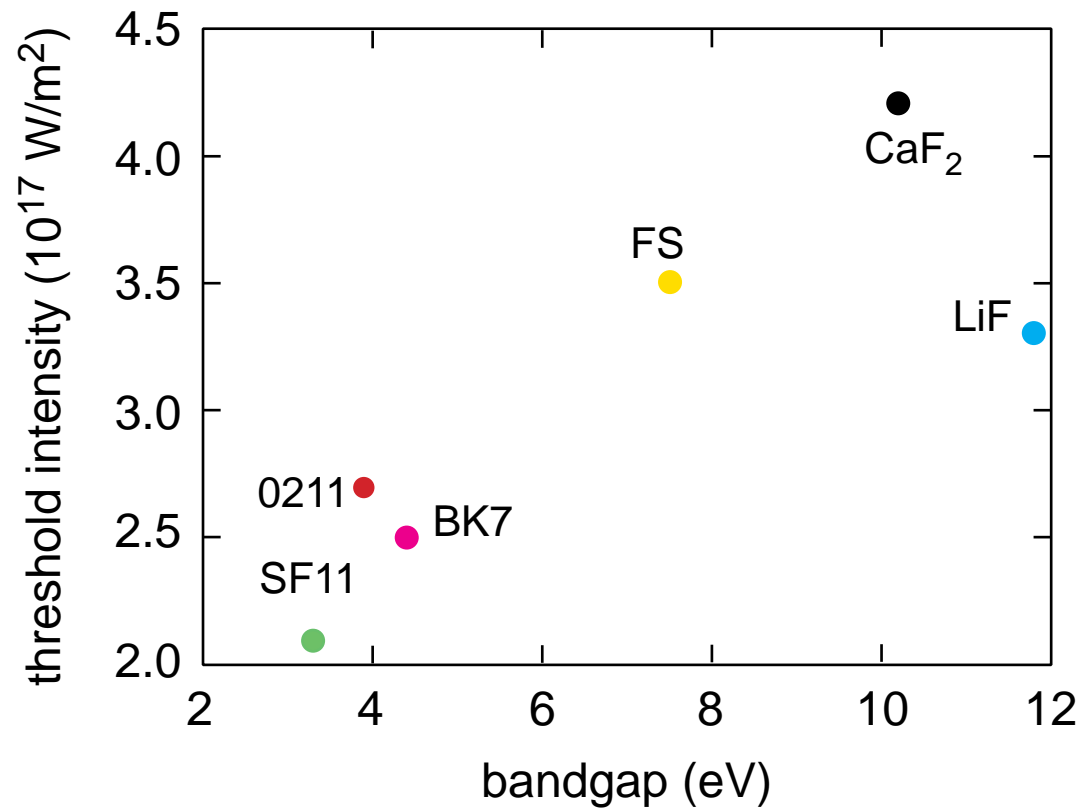

Femtosecond micromachining

...threshold varies with band gap (but not much!)

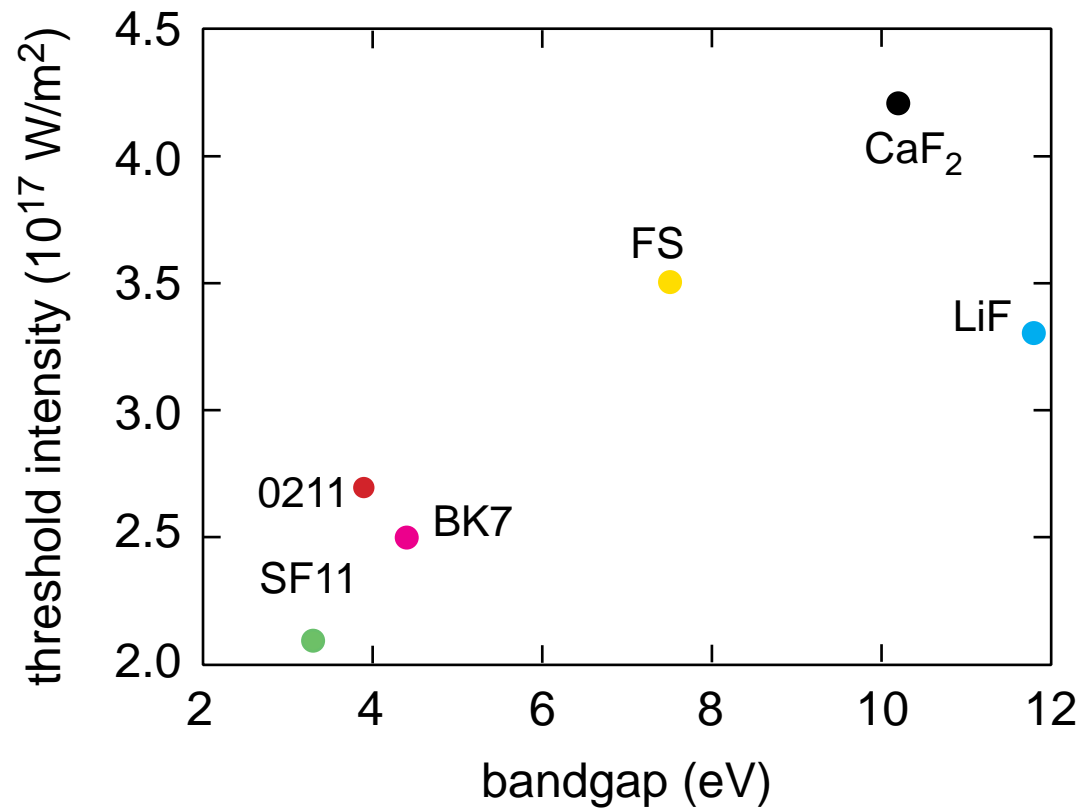

Femtosecond micromachining

would expect much more than a factor of 2

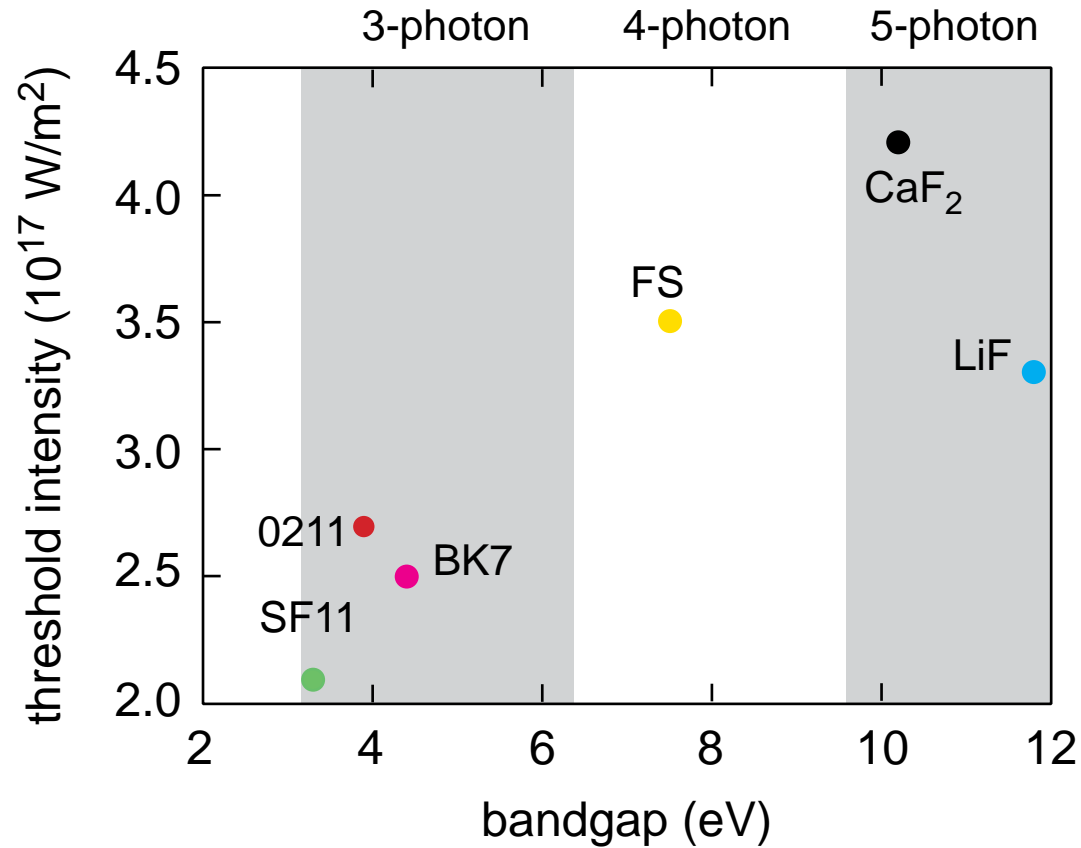

Femtosecond micromachining

critical density reached by multiphoton for low gap only

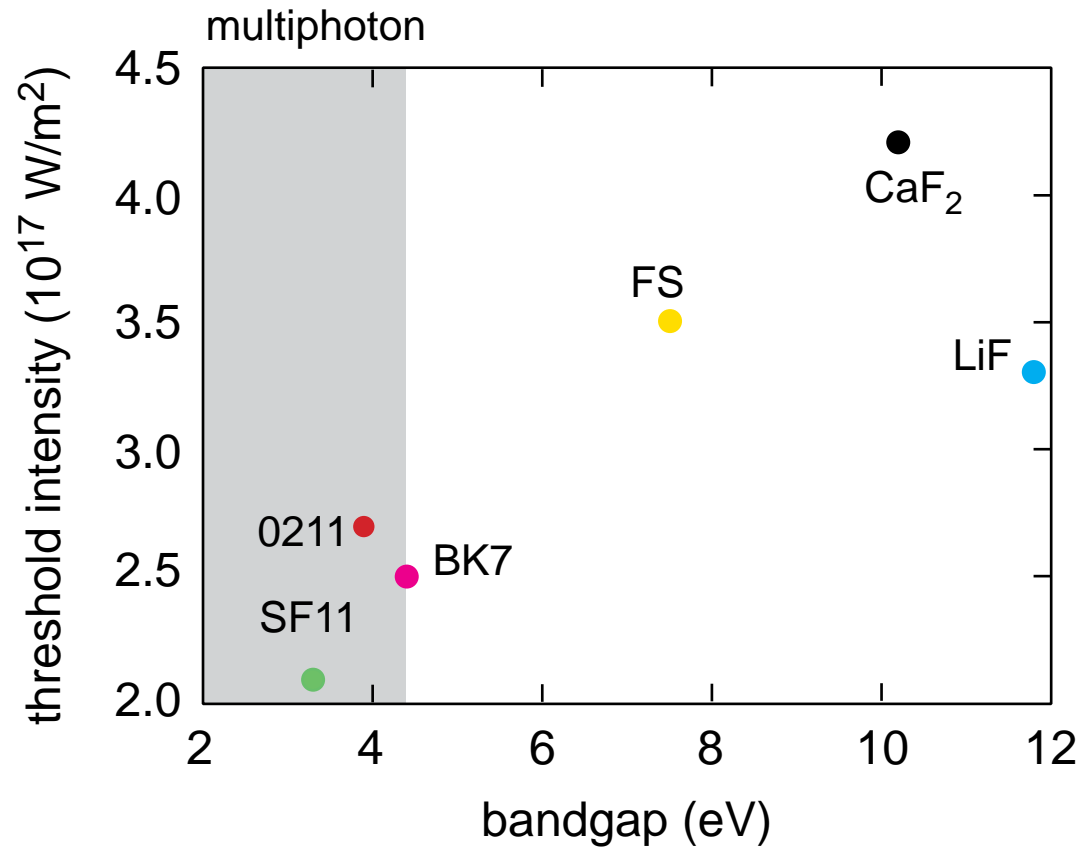

Femtosecond micromachining

avalanche ionization important at high gap

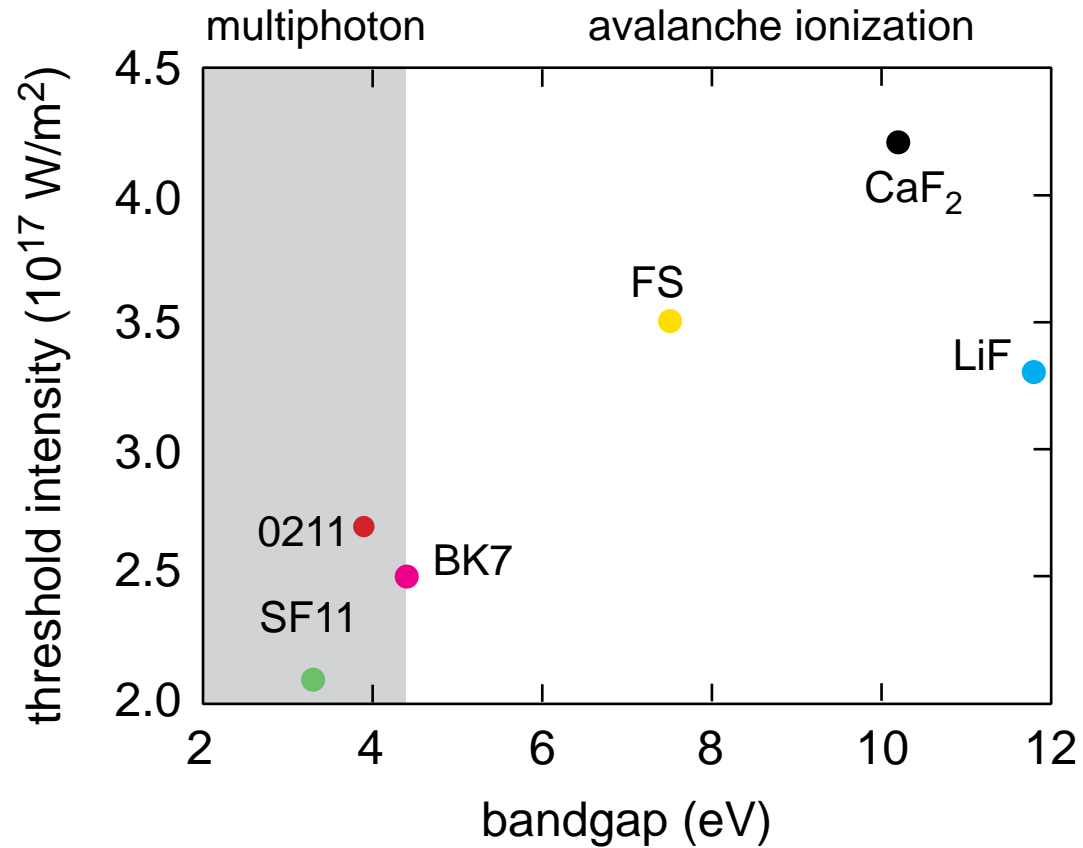

Femtosecond micromachining

what prevents damage at low NA?

Femtosecond micromachining

Competing nonlinear effects:

- **multiphoton absorption**
- **supercontinuum generation**
- **self-focusing**

Femtosecond micromachining

why the difference?

high NA



low NA

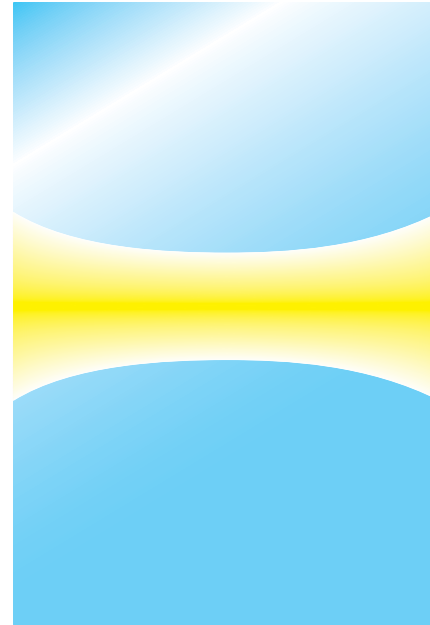

Femtosecond micromachining

very different confocal length/interaction length

high NA

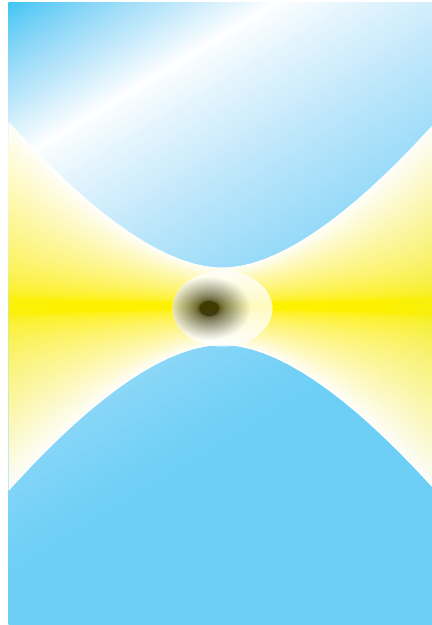

low NA

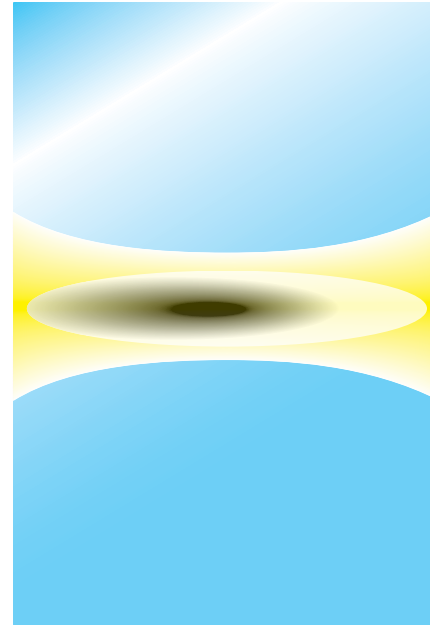

Femtosecond micromachining

high NA: interaction length too short for self-focusing

Femtosecond micromachining

threshold for supercontinuum generation

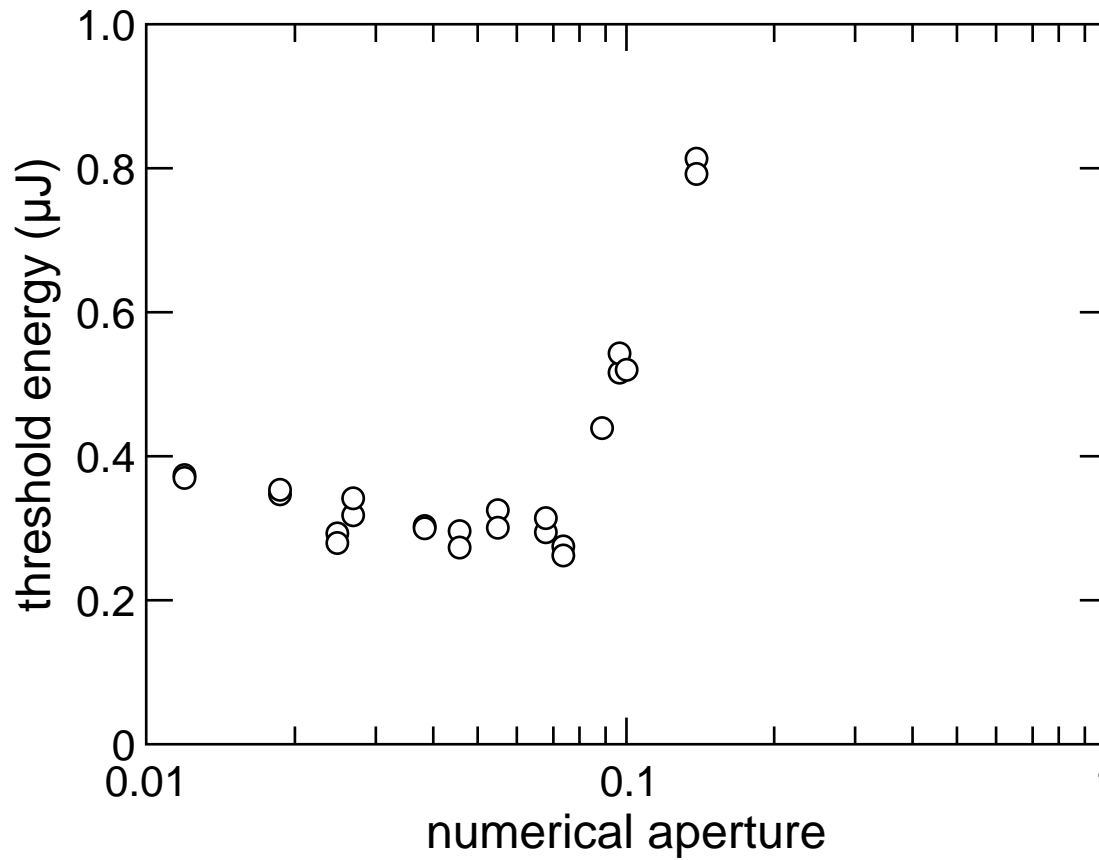

Femtosecond micromachining

threshold for damage

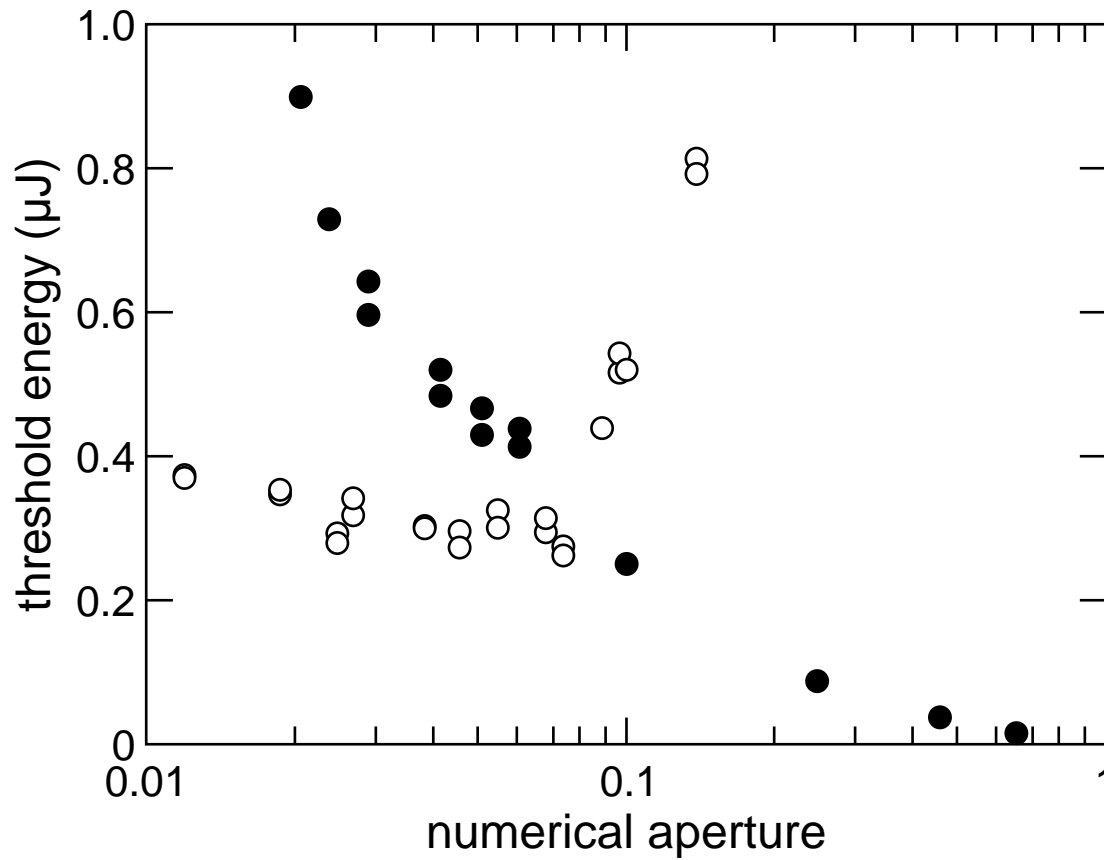

Femtosecond micromachining

Points to keep in mind:

- **threshold critically dependent on NA**
- **surprisingly little material dependence**
- **avalanche ionization important**

Outline

- femtosecond micromachining
- low-energy machining
- applications

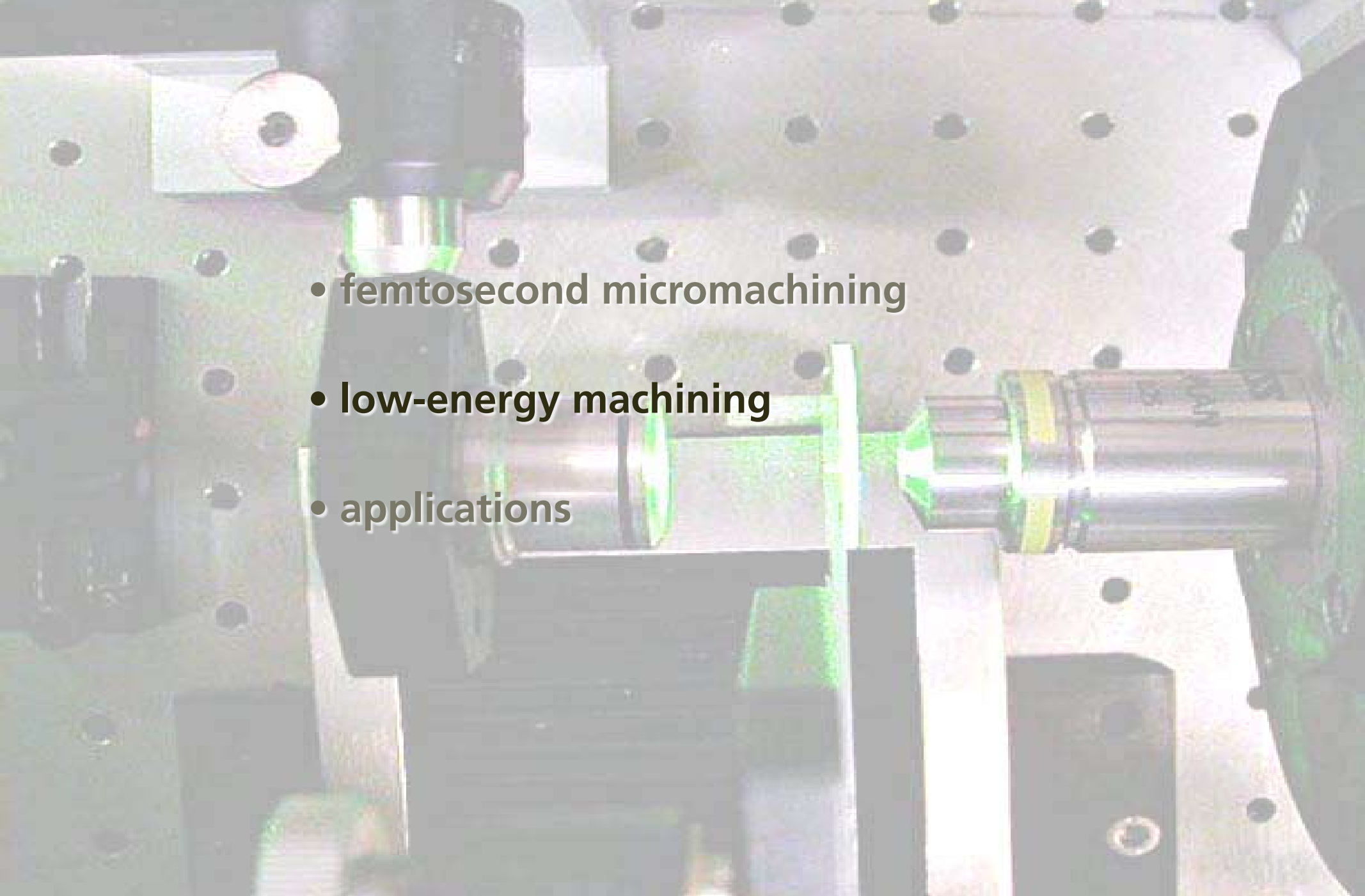

Low-energy machining

threshold decreases with increasing numerical aperture

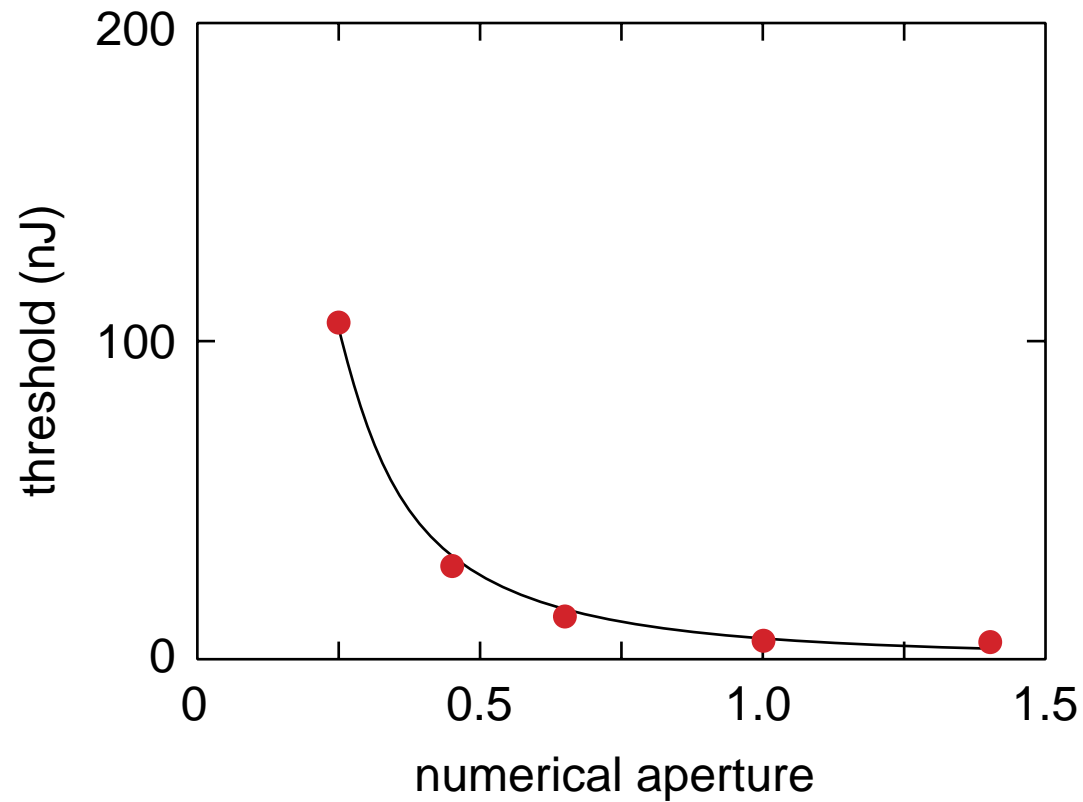

Low-energy machining

less than 10 nJ at high numerical aperture!

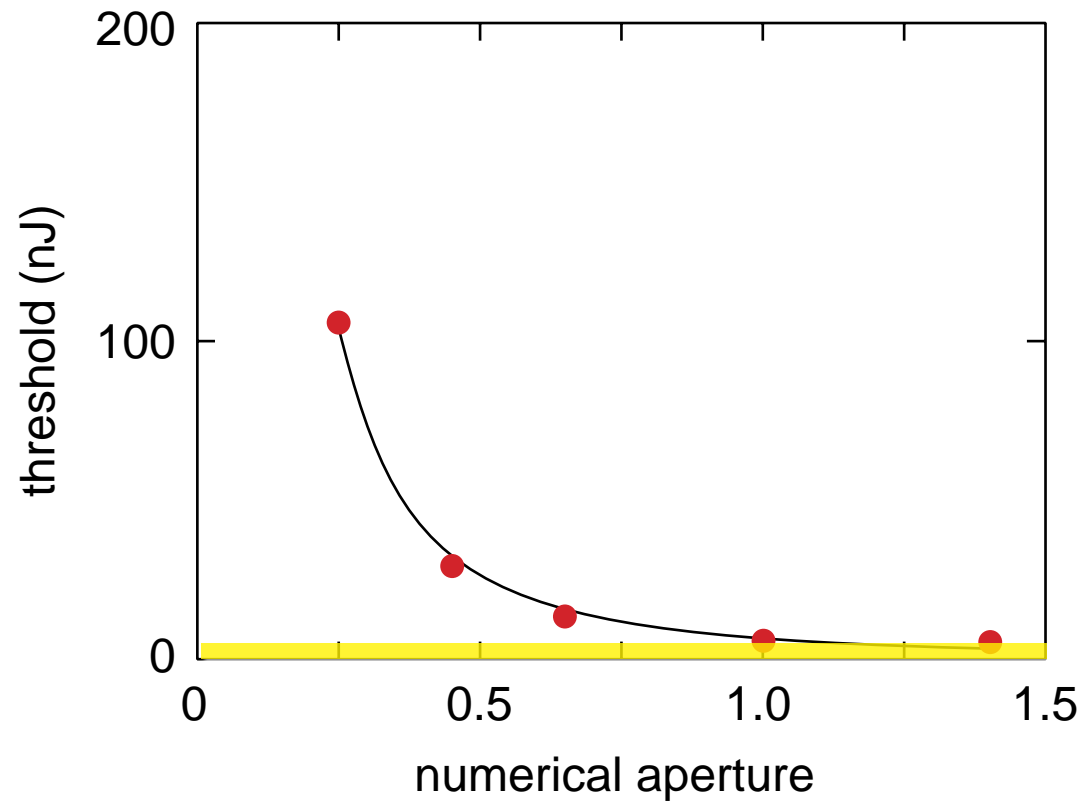

Low-energy machining

amplified laser: 1 kHz, 1 mJ

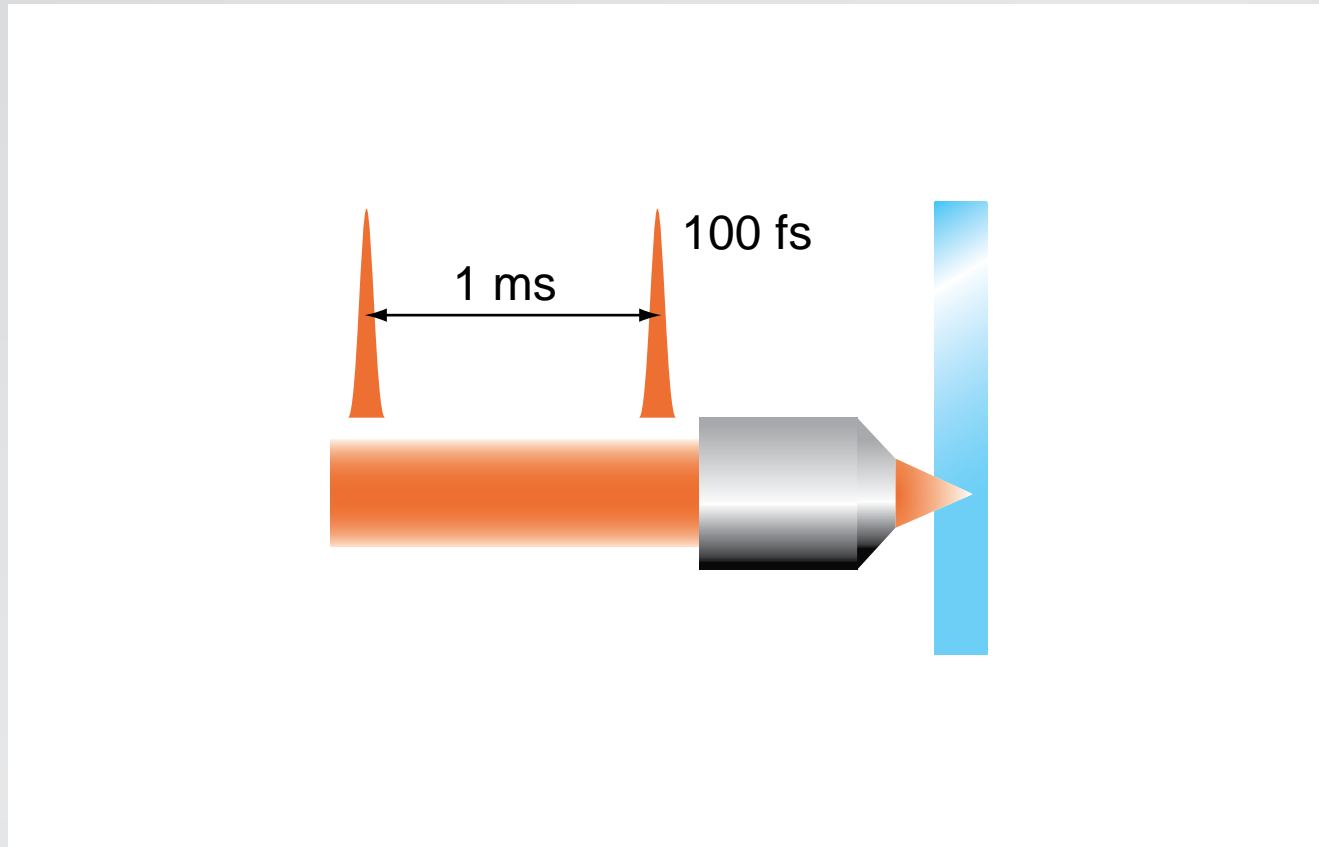

heat diffusion time: $\tau_{diff} \approx 1 \mu\text{s}$

Low-energy machining

long cavity oscillator: 25 MHz, 25 nJ

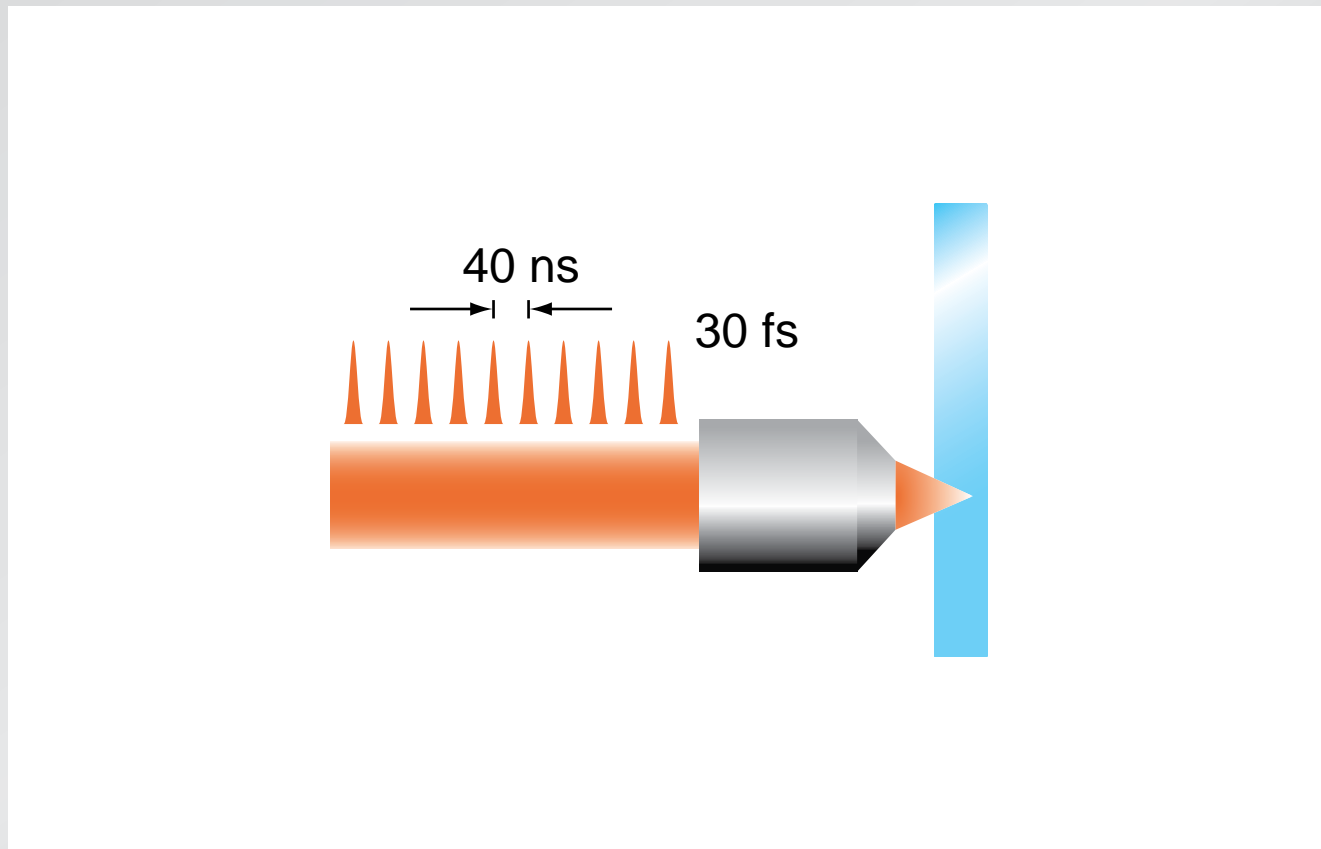

heat diffusion time: $\tau_{diff} \approx 1 \mu\text{s}$

Low-energy machining

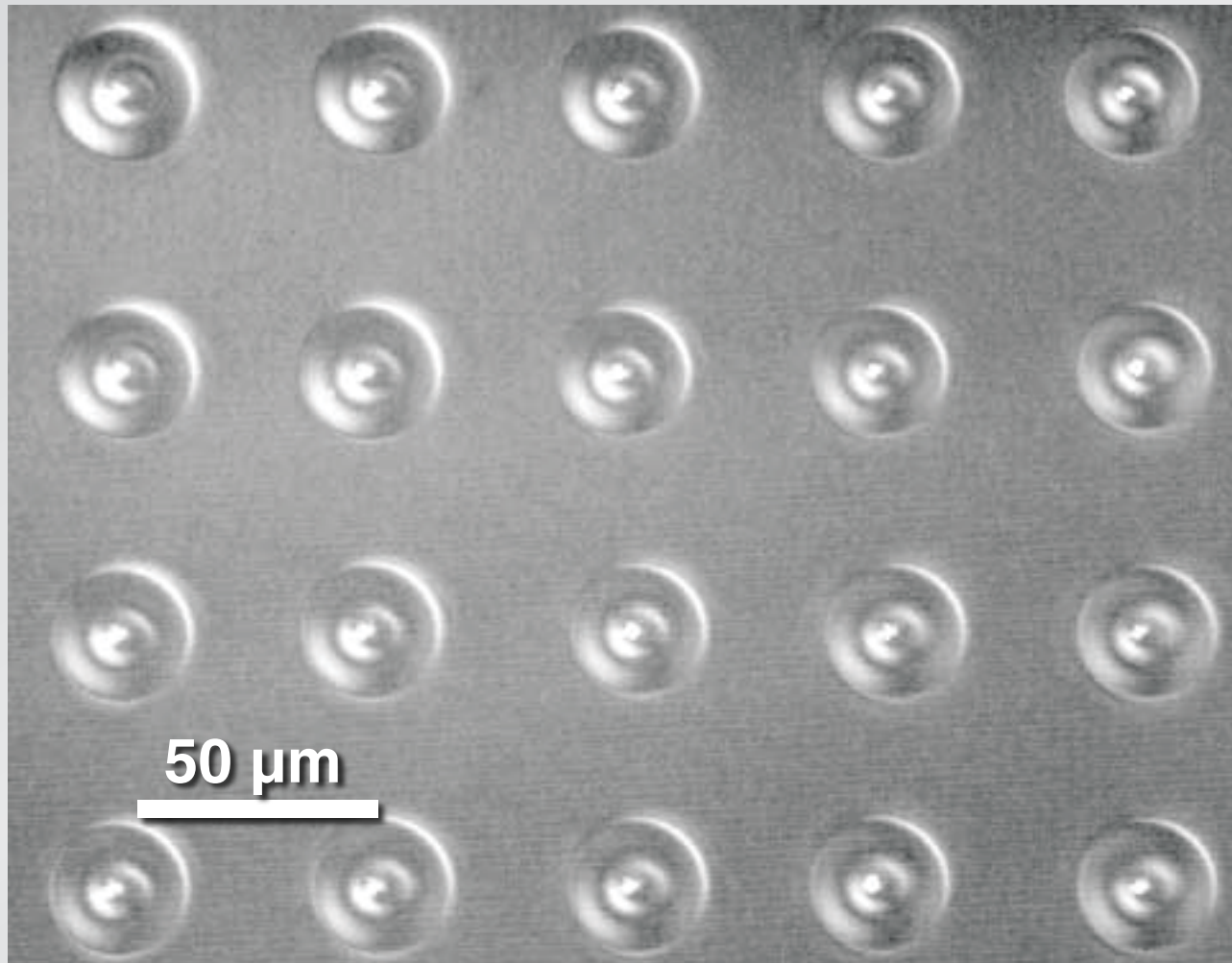

Low-energy machining

High repetition-rate micromachining:

- **structural changes exceed focal volume**
- **spherical structures**
- **density change caused by melting**

Low-energy machining

amplified laser

oscillator

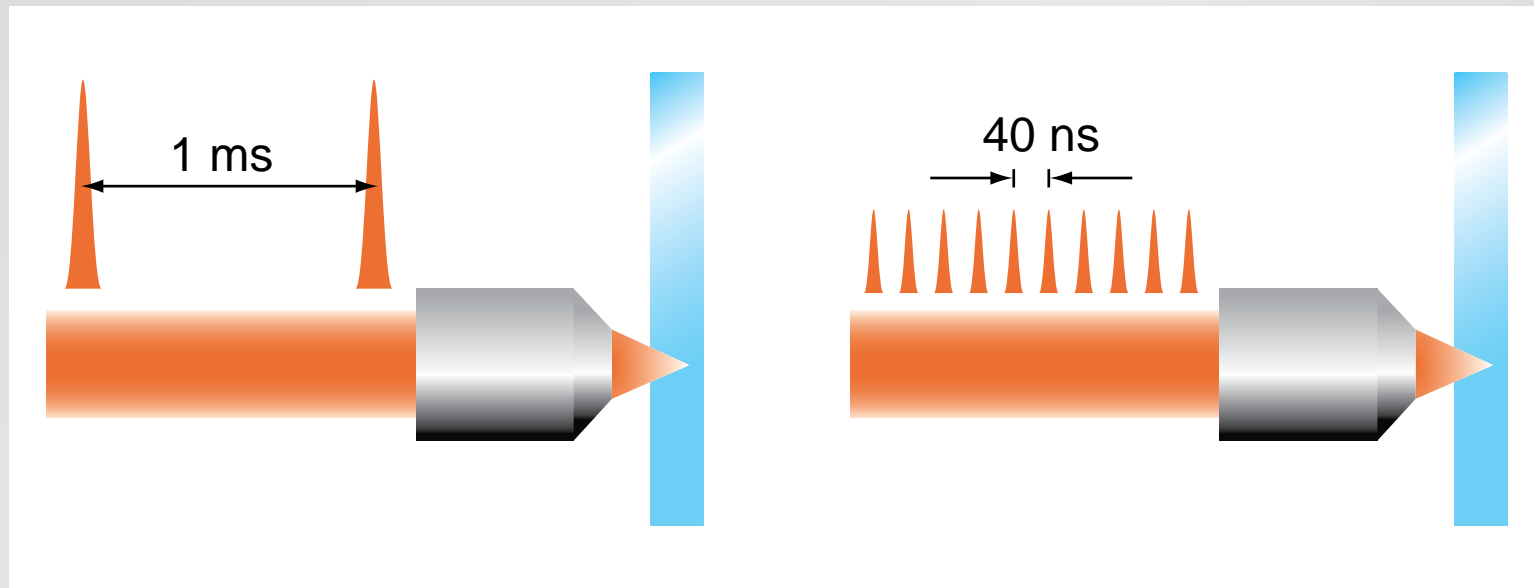

repetitive

cumulative

Low-energy machining

amplified laser

oscillator

low repetition rate

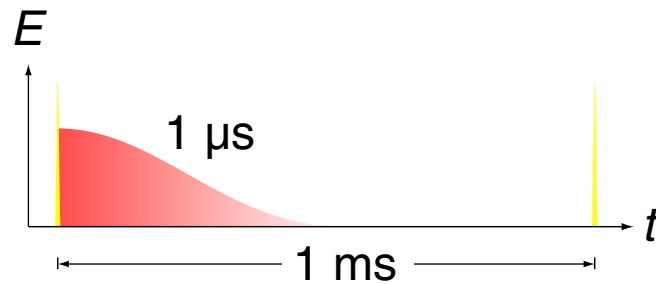

high repetition rate

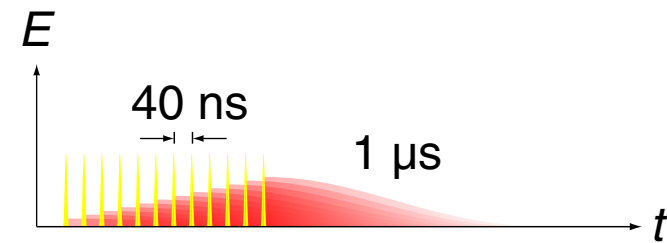

repetitive

cumulative

Low-energy machining

the longer the irradiation...

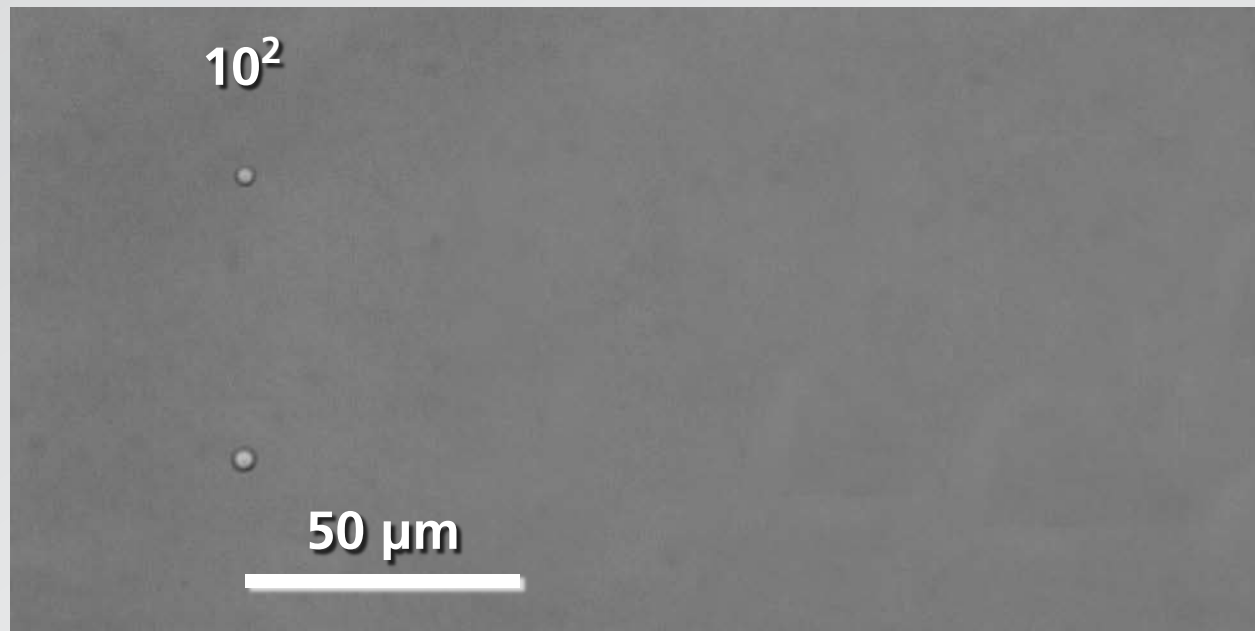

Low-energy machining

the longer the irradiation...

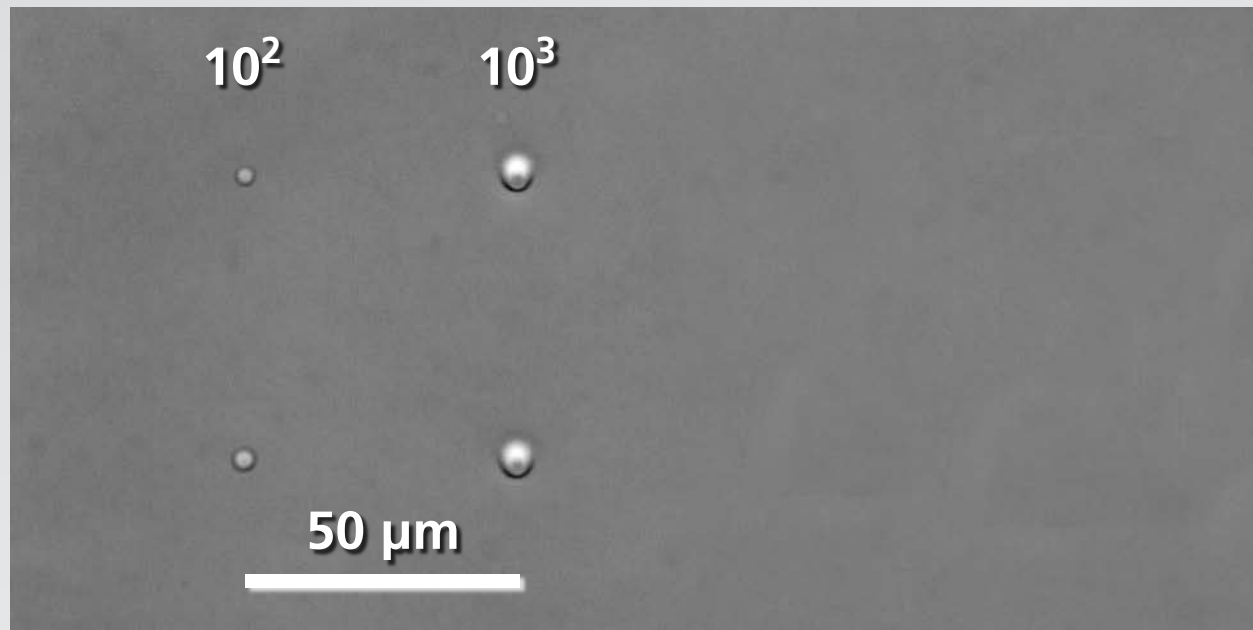

Low-energy machining

the longer the irradiation...

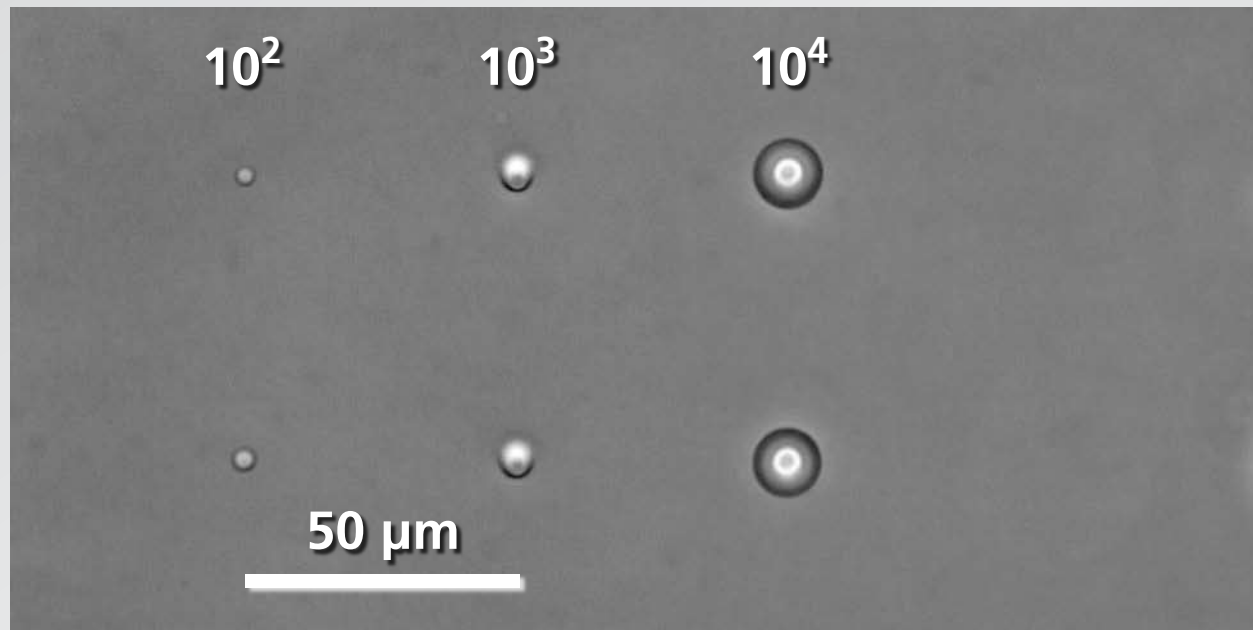

Low-energy machining

the longer the irradiation...

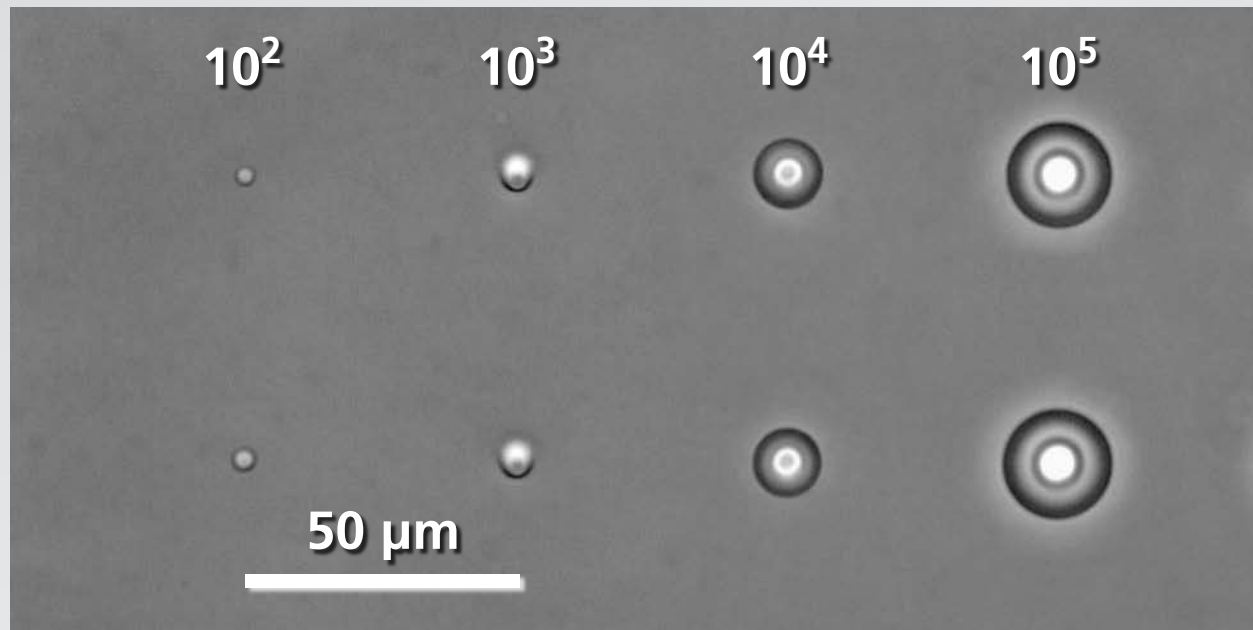

... the larger the radius

Low-energy machining

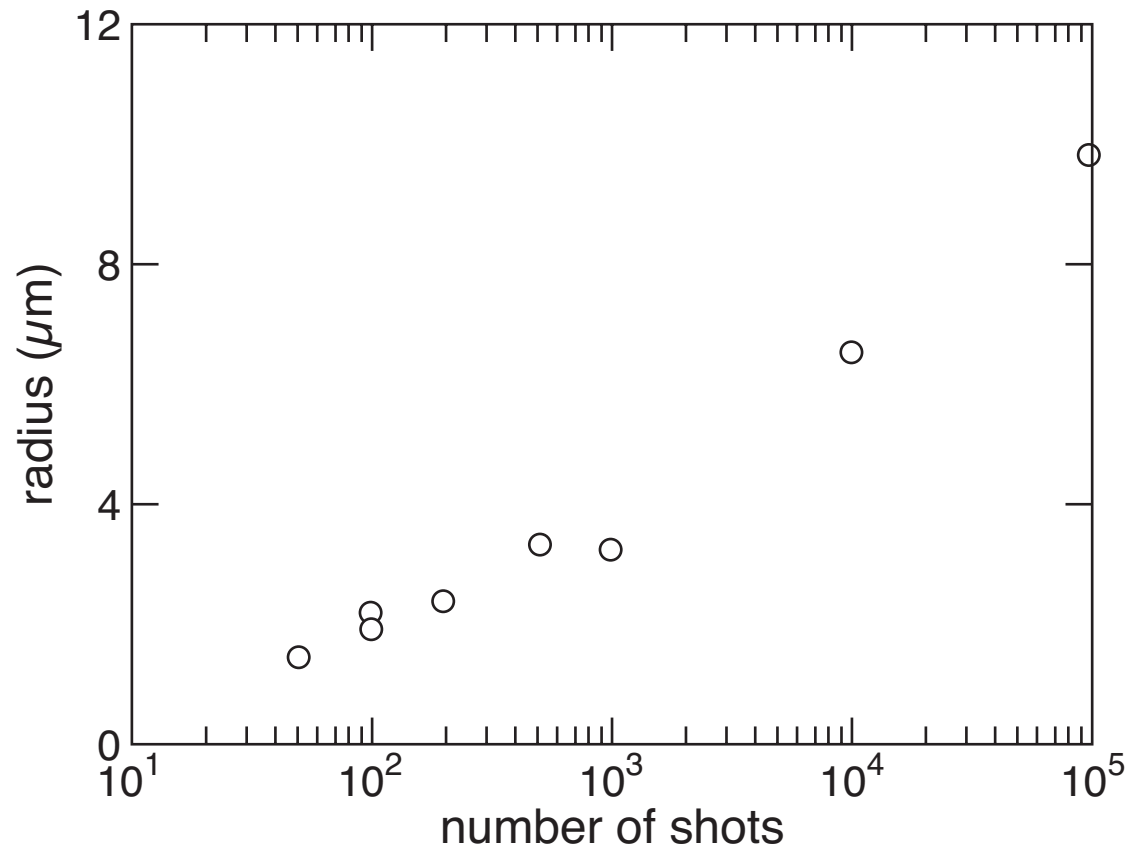

Low-energy machining

at high-rep rate: internal “point-source of heat”

Outline

- femtosecond micromachining
- low-energy machining
- applications

Low-energy machining

waveguide micromachining

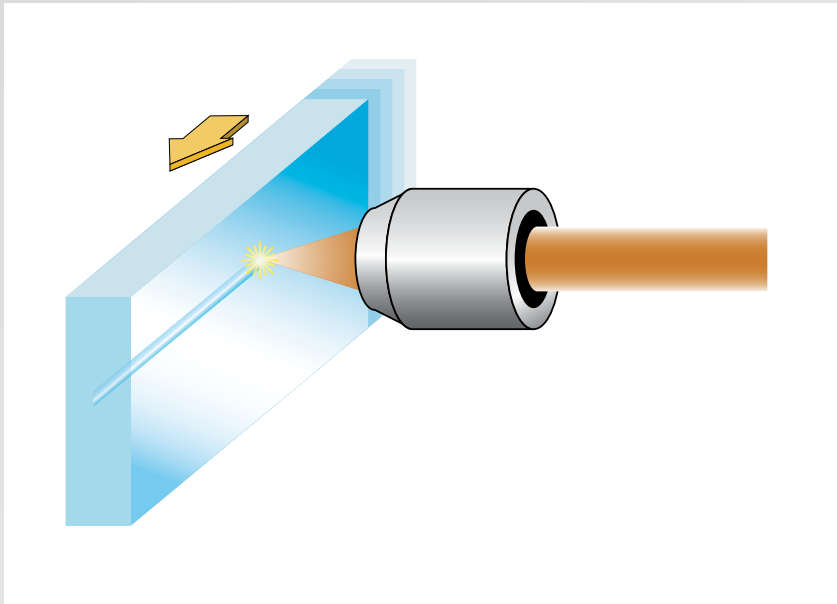

Low-energy machining

waveguide micromachining

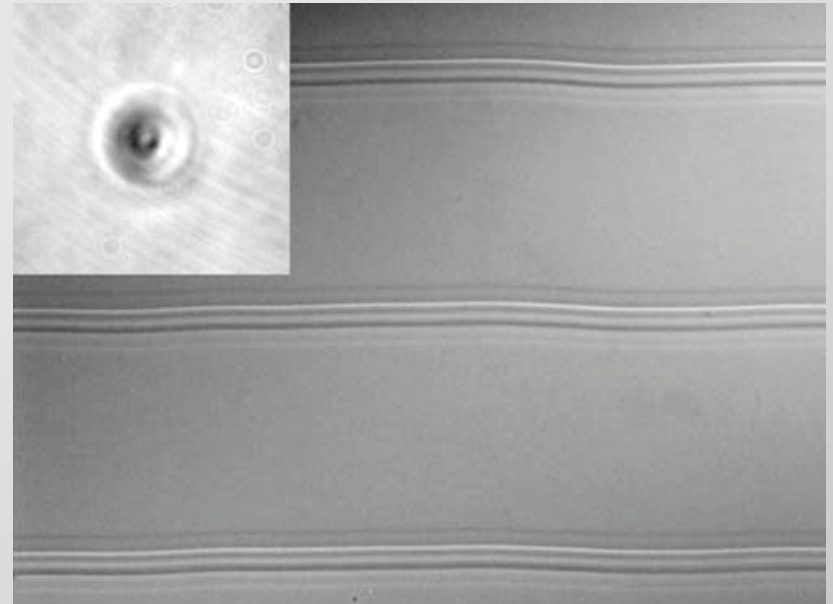
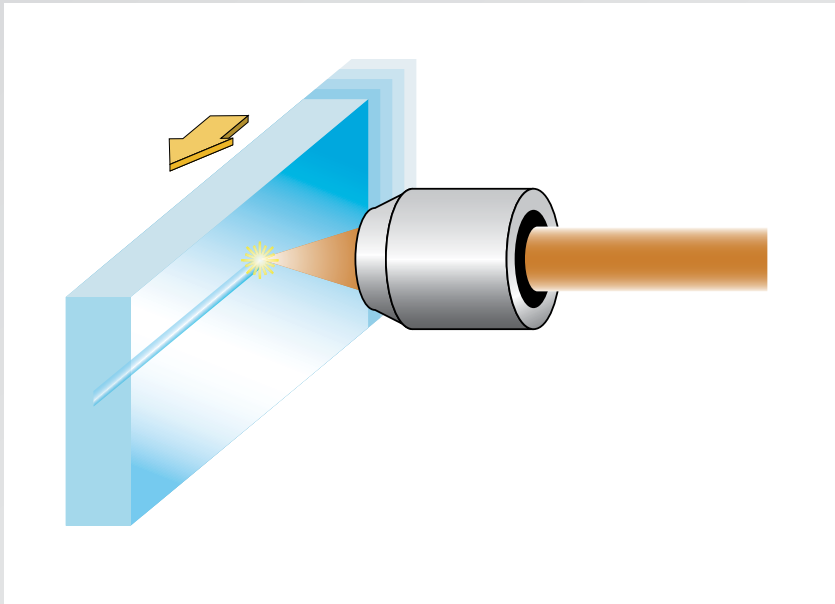

Applications

curved waveguides

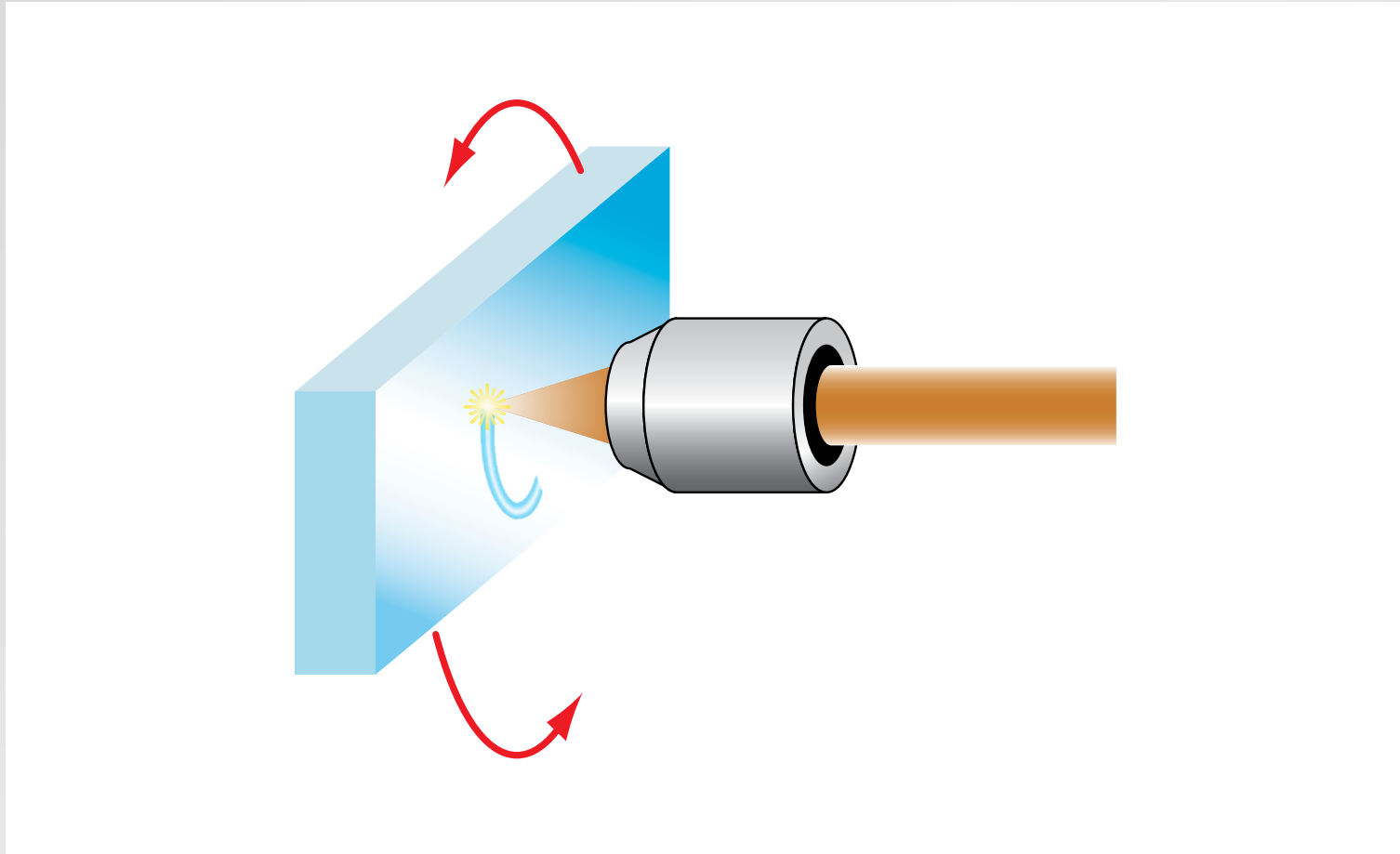

Applications

curved waveguides

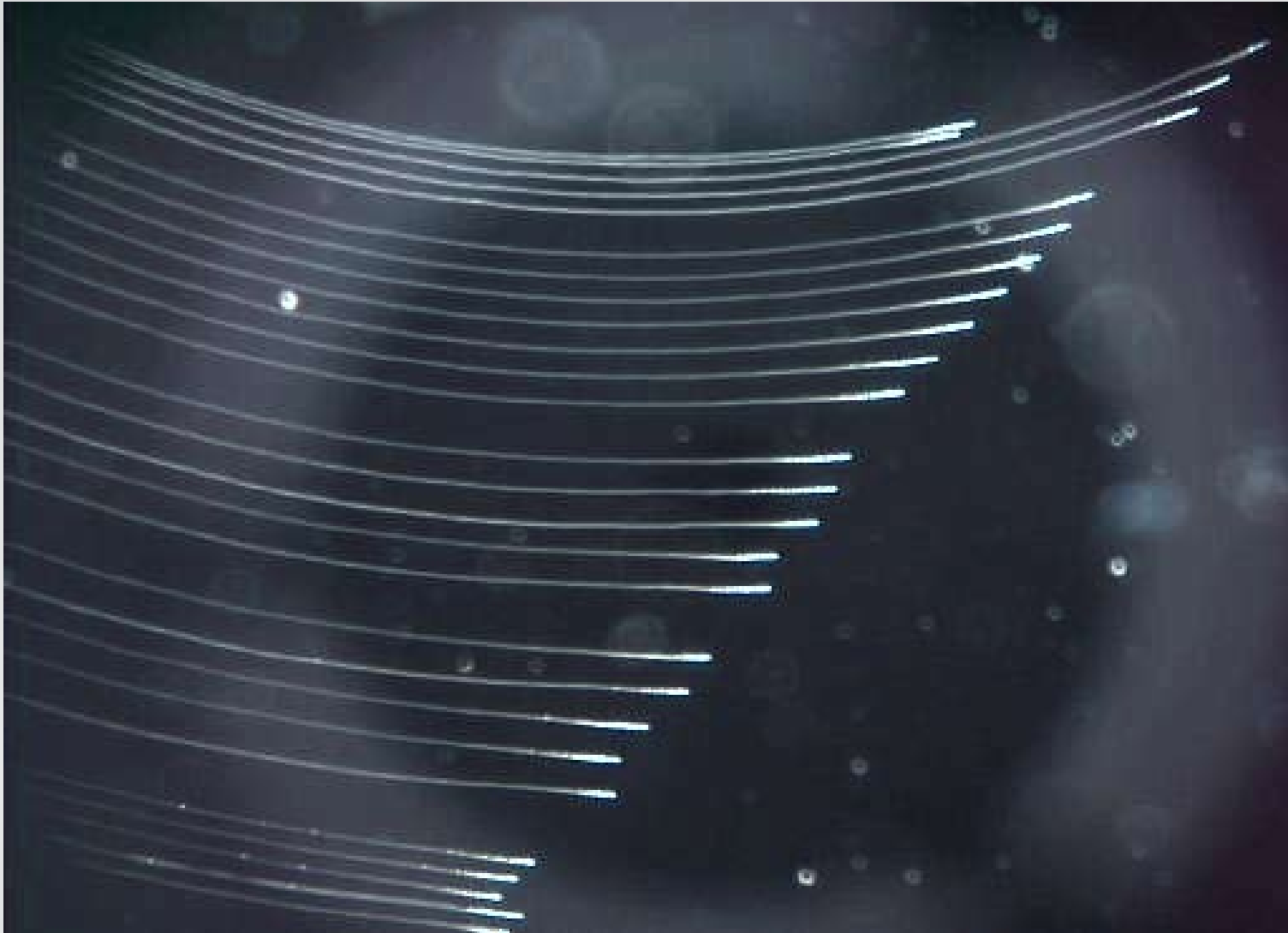

Applications

curved waveguides

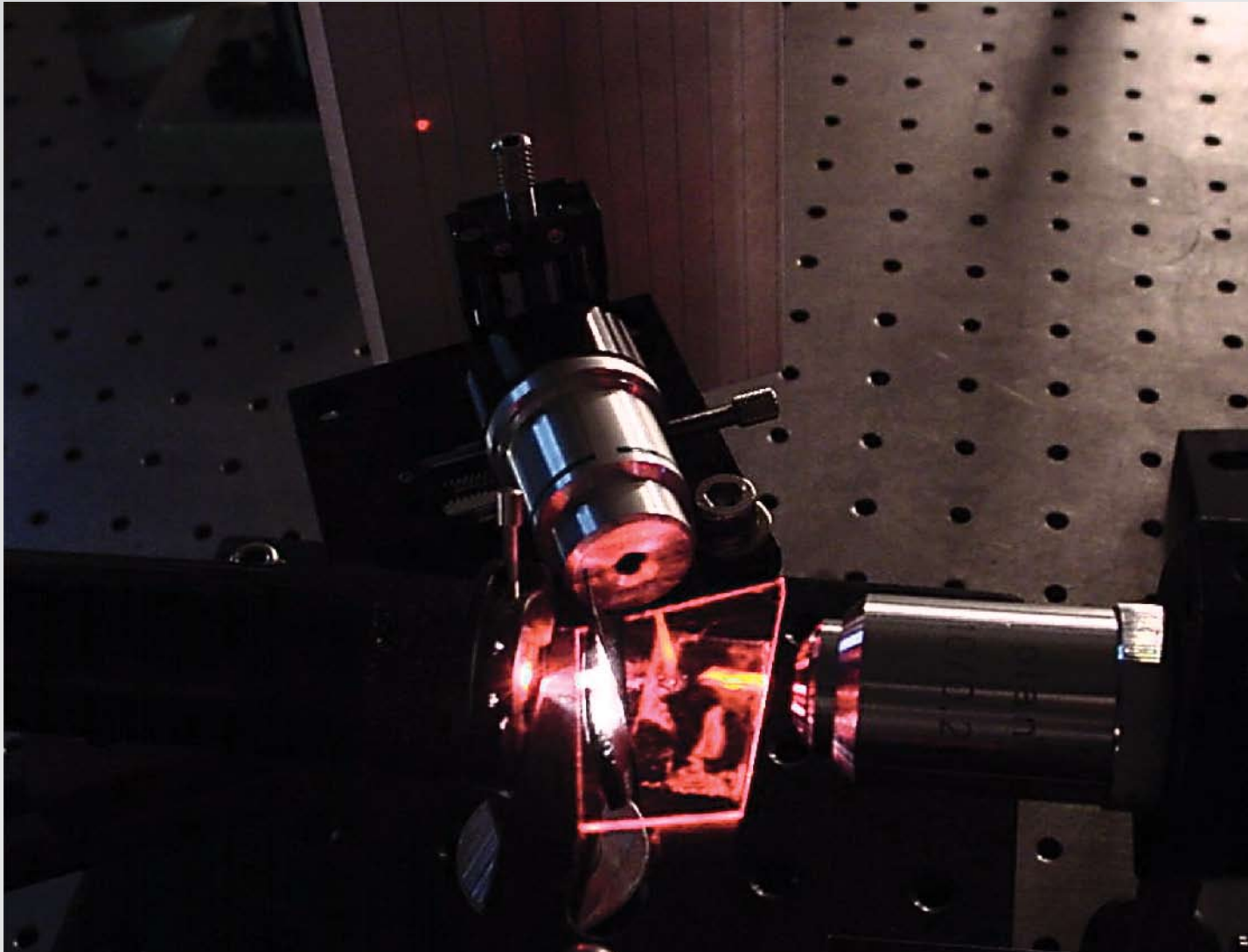

Applications

curved waveguides

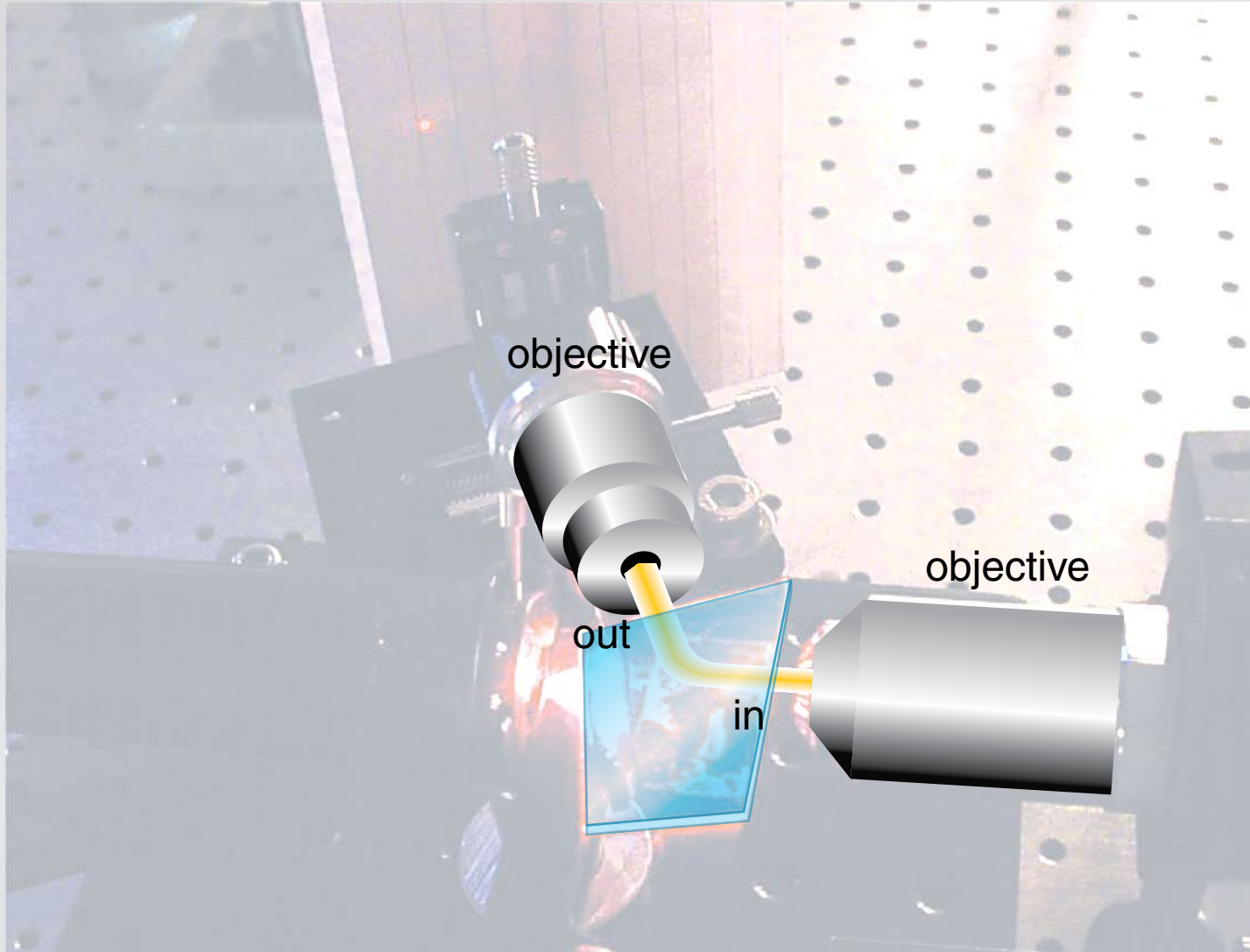

Applications

curved waveguides

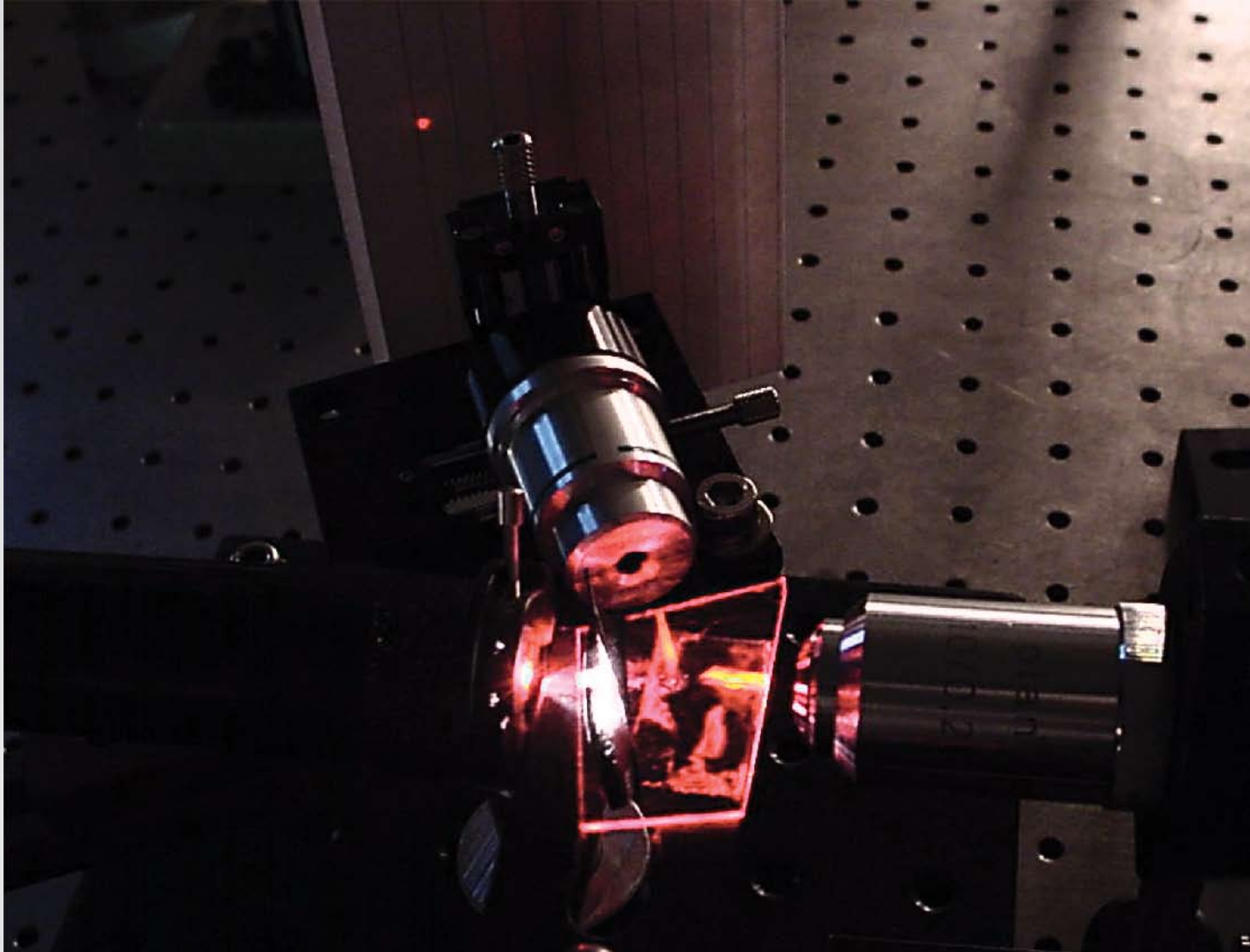

Applications

photonic fabrication techniques

| | fs micromachining | other |
|----------------|--------------------|-----------------|
| loss (dB/cm) | < 3 | 0.1–3 |
| bending radius | 36 mm | 30–40 mm |
| Δn | 2×10^{-3} | $10^{-4} - 0.5$ |
| 3D integration | Y | N |

Applications

photonic devices

3D splitter



Bragg grating

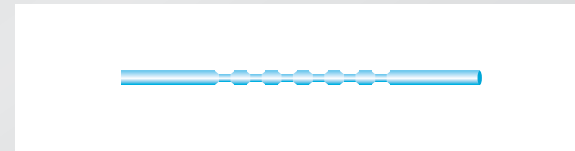

demultiplexer

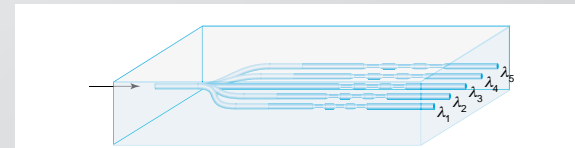

amplifier

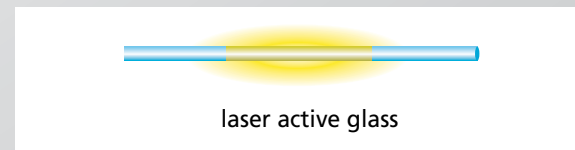

interferometer

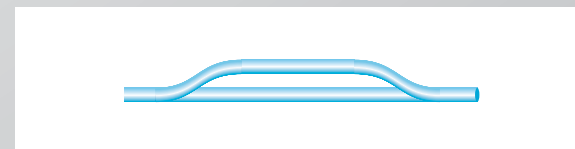

Applications

all-optical sensor



substrate

Applications

all-optical sensor



Applications

all-optical sensor

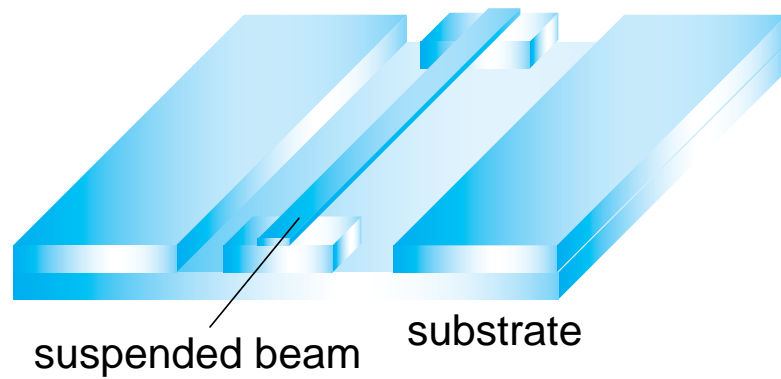

Applications

all-optical sensor

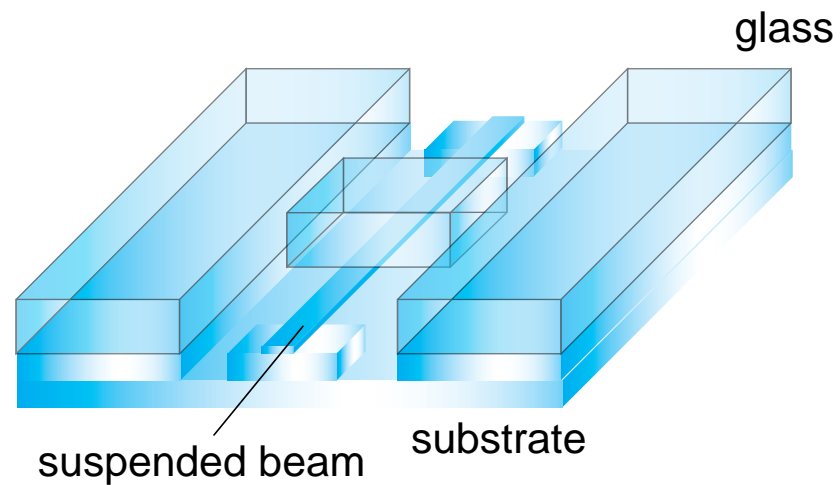

Applications

all-optical sensor

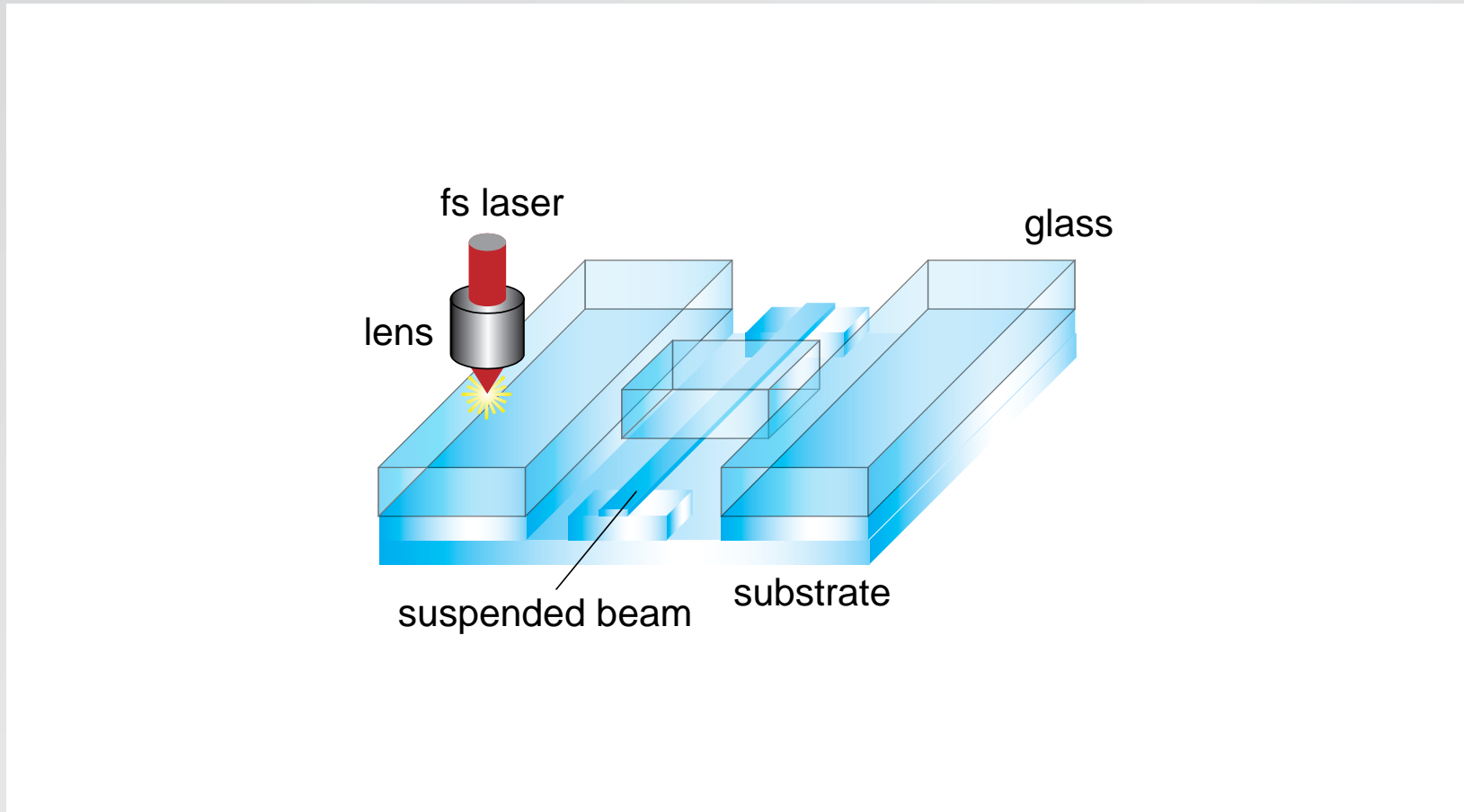

Applications

all-optical sensor

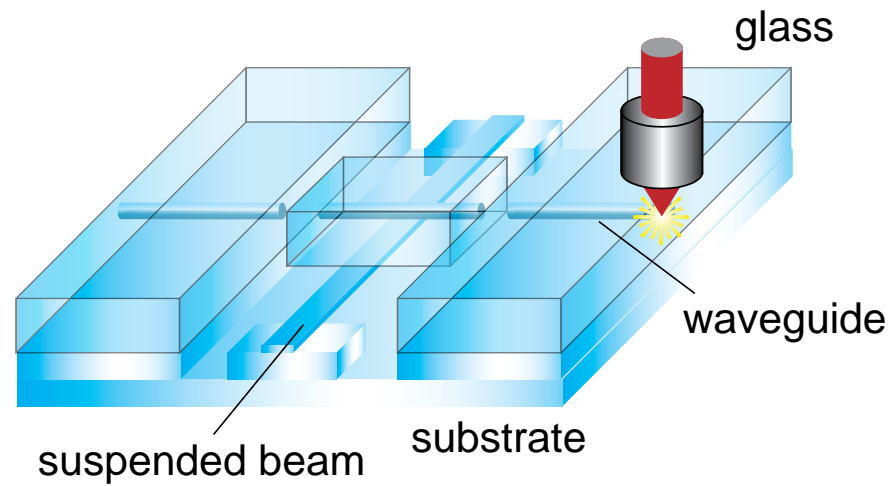

Applications

all-optical sensor

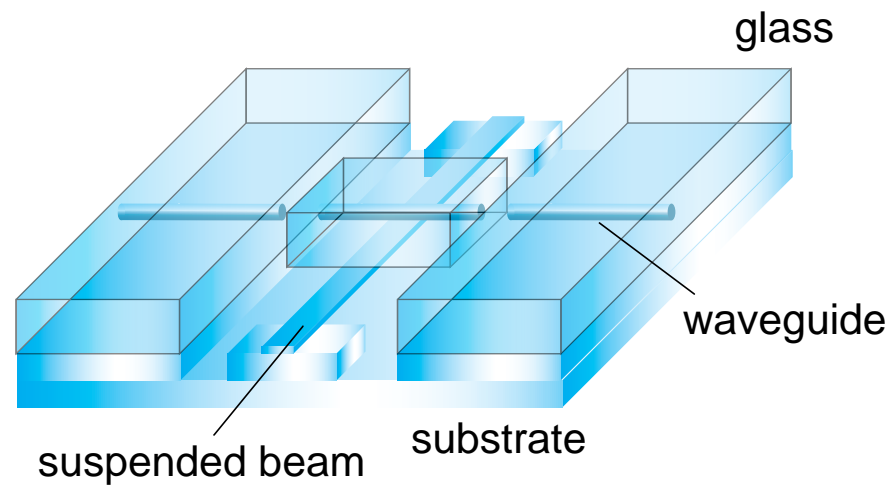

Applications

all-optical sensor

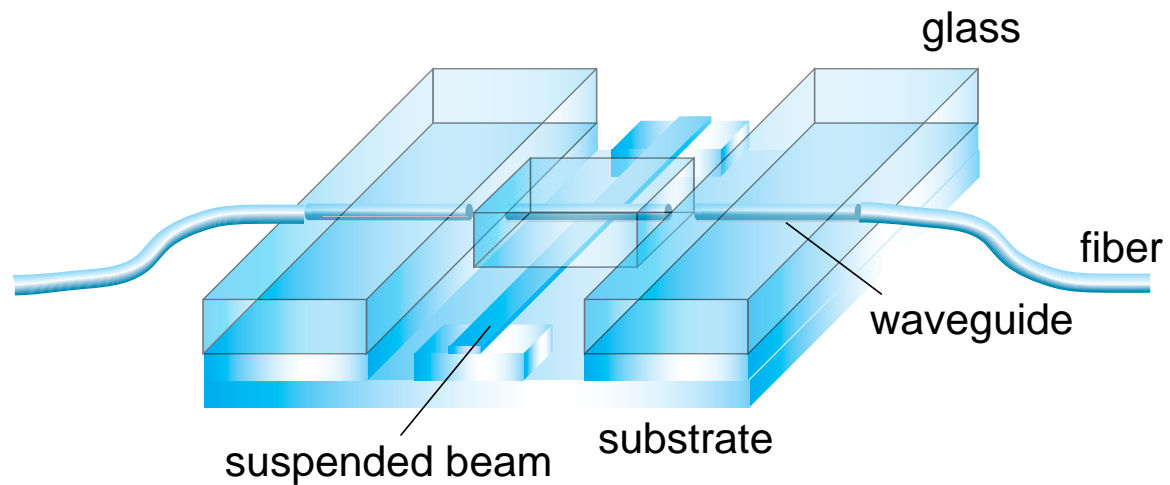

Applications

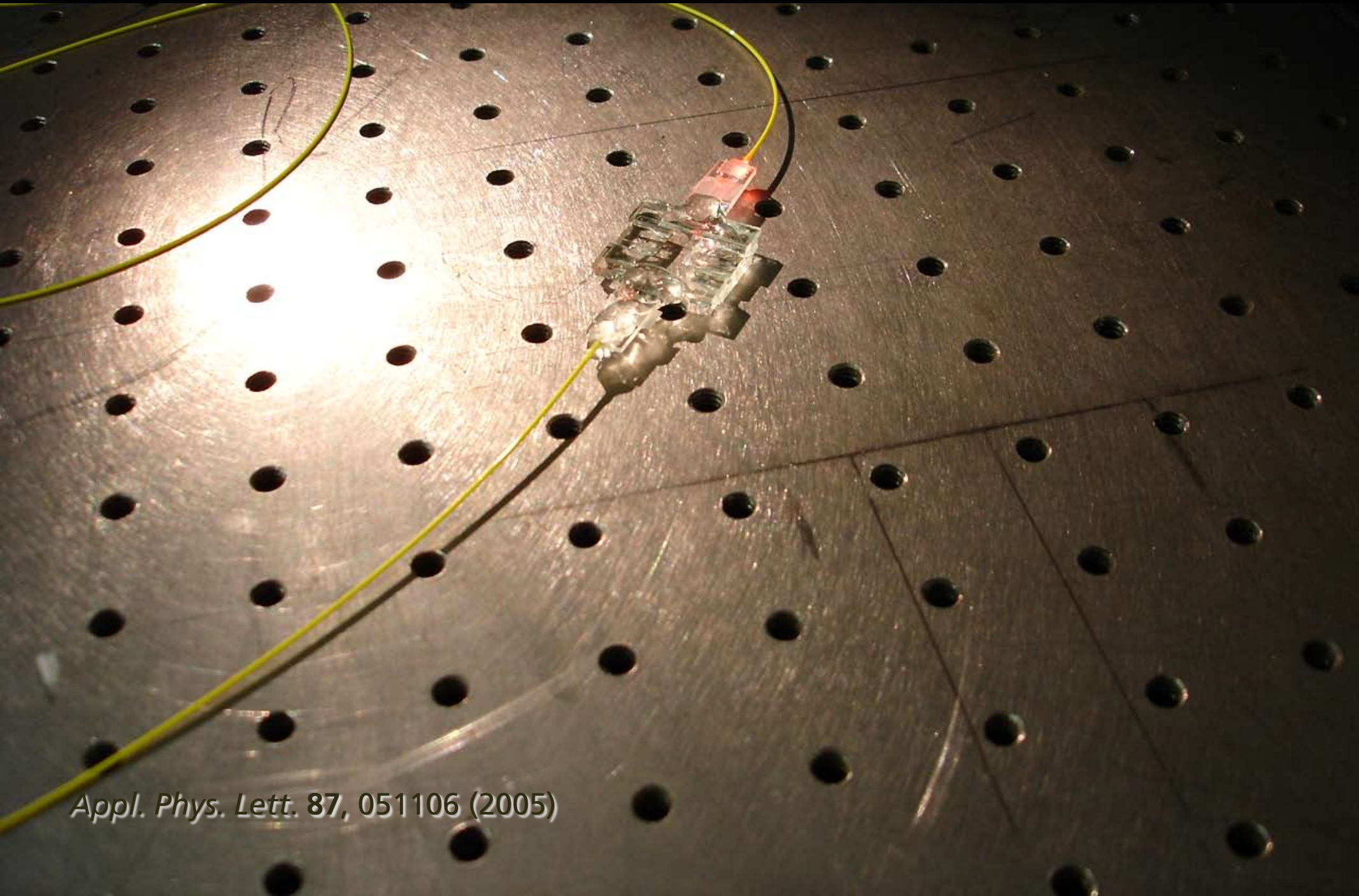

Appl. Phys. Lett. 87, 051106 (2005)

Applications

sensor gap

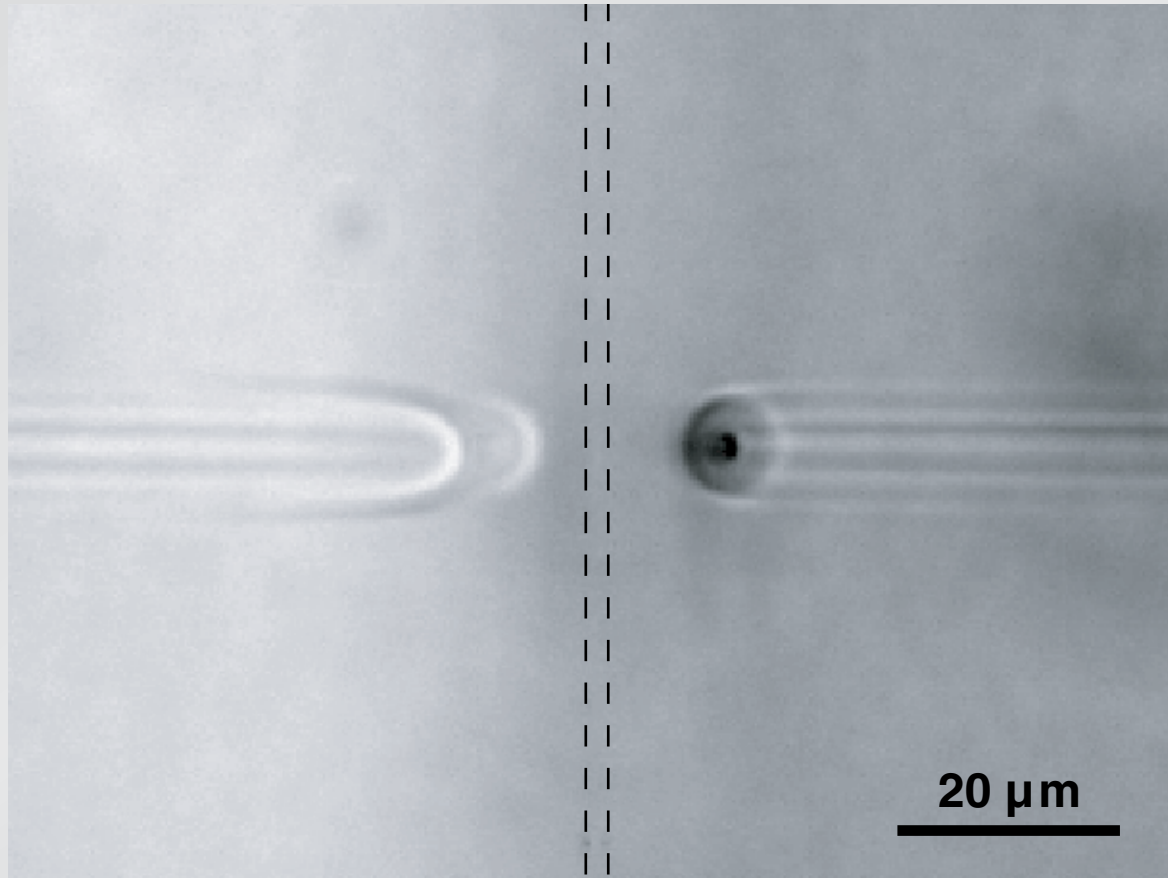

Appl. Phys. Lett. **87**, 051106 (2005)

Applications

calibration

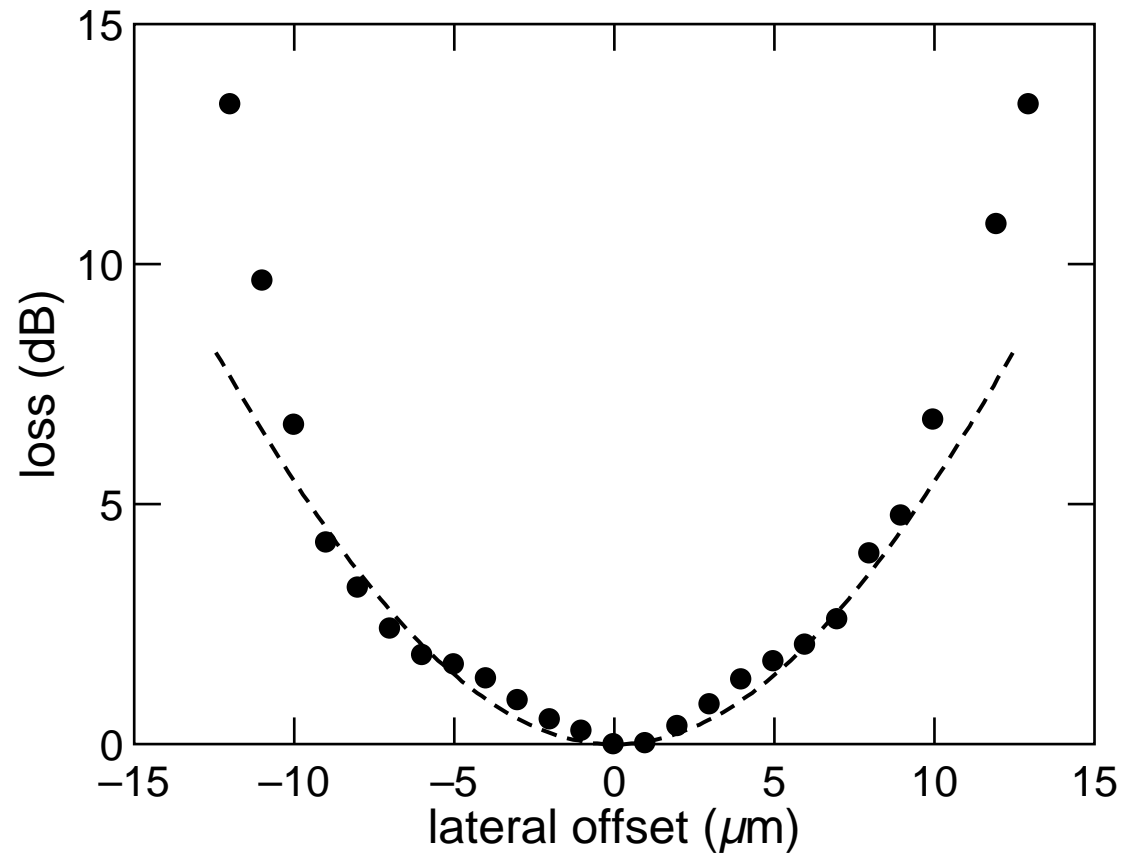

Applications

sensor response to 100 Hz acoustic wave

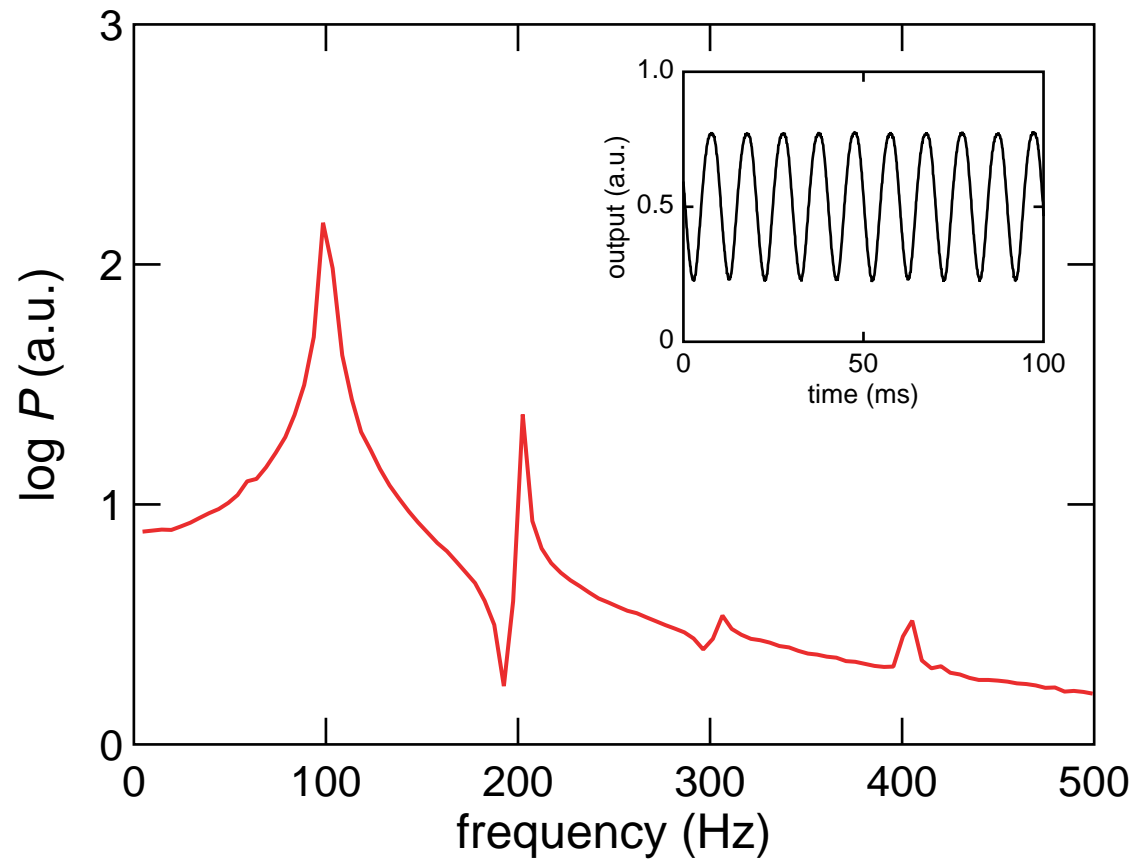

Applications

ideal tool for ablating (living) tissue

Applications

- **standard biochemical tools: species selective**
- **fs laser “nanosurgery”: site specific**

Applications

Q: can we probe the dynamics of the cytoskeleton?

Applications

actin fiber network of a live cell

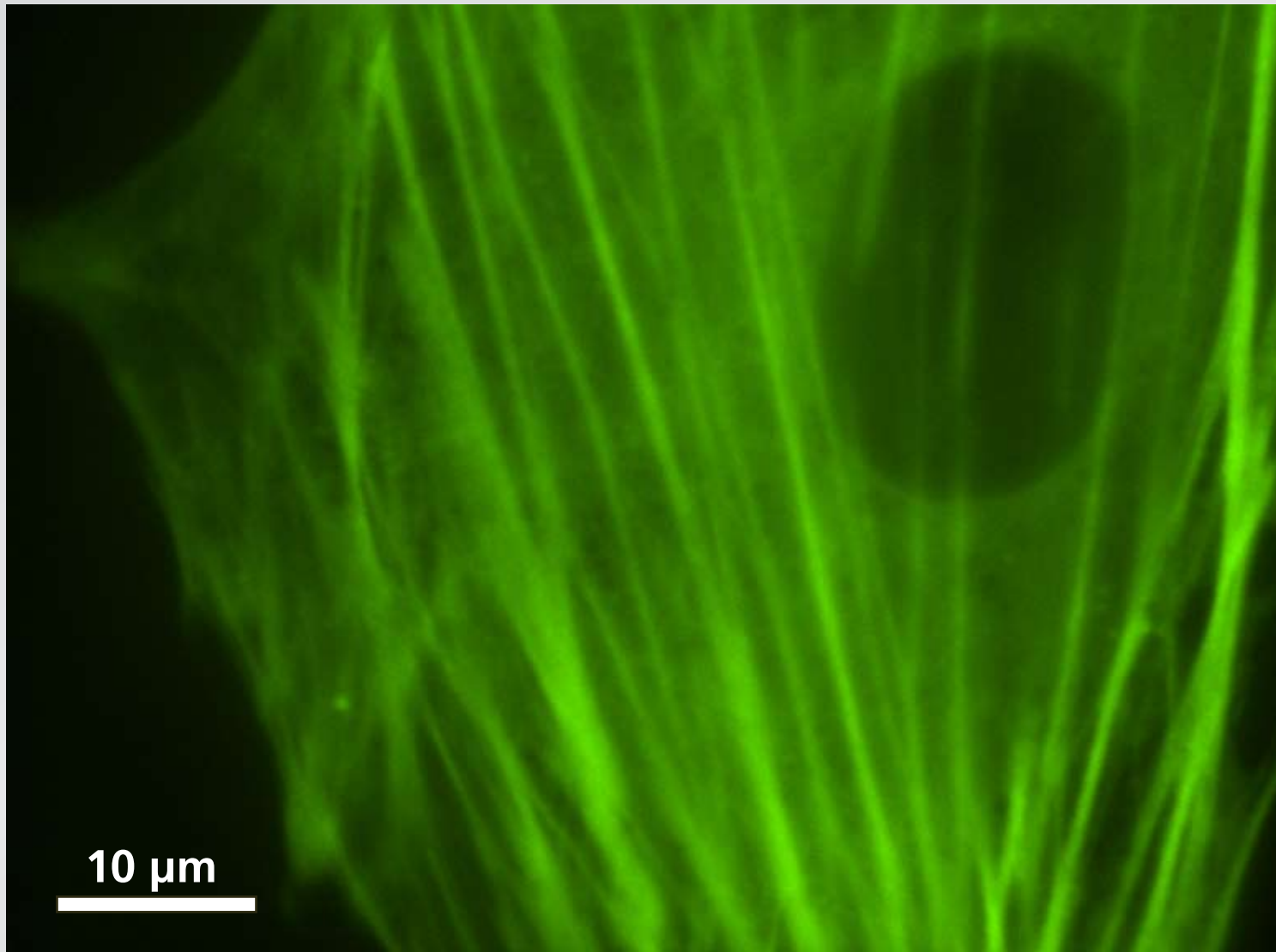

Applications

cut a single fiber bundle

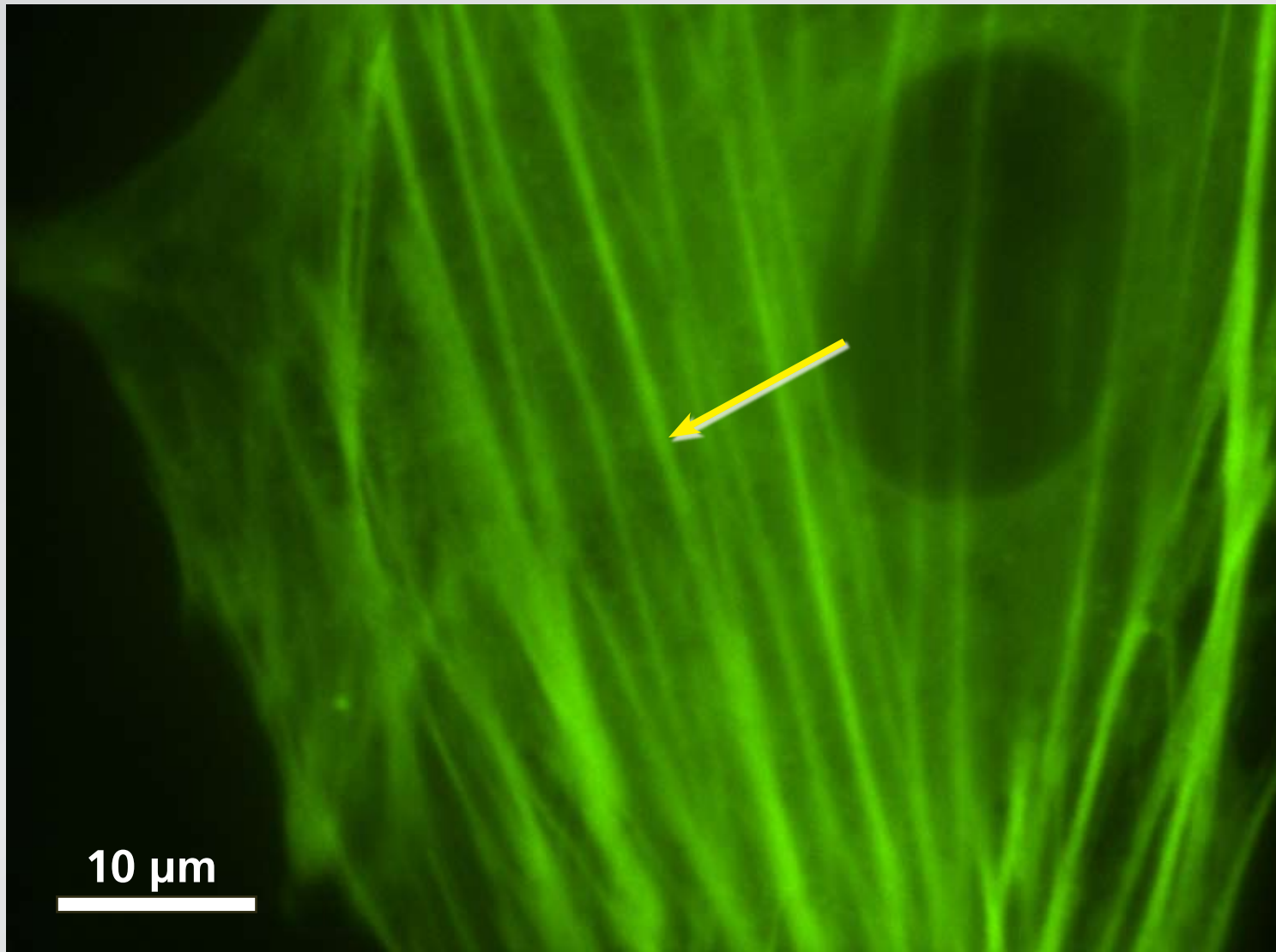

Applications

cut a single fiber bundle

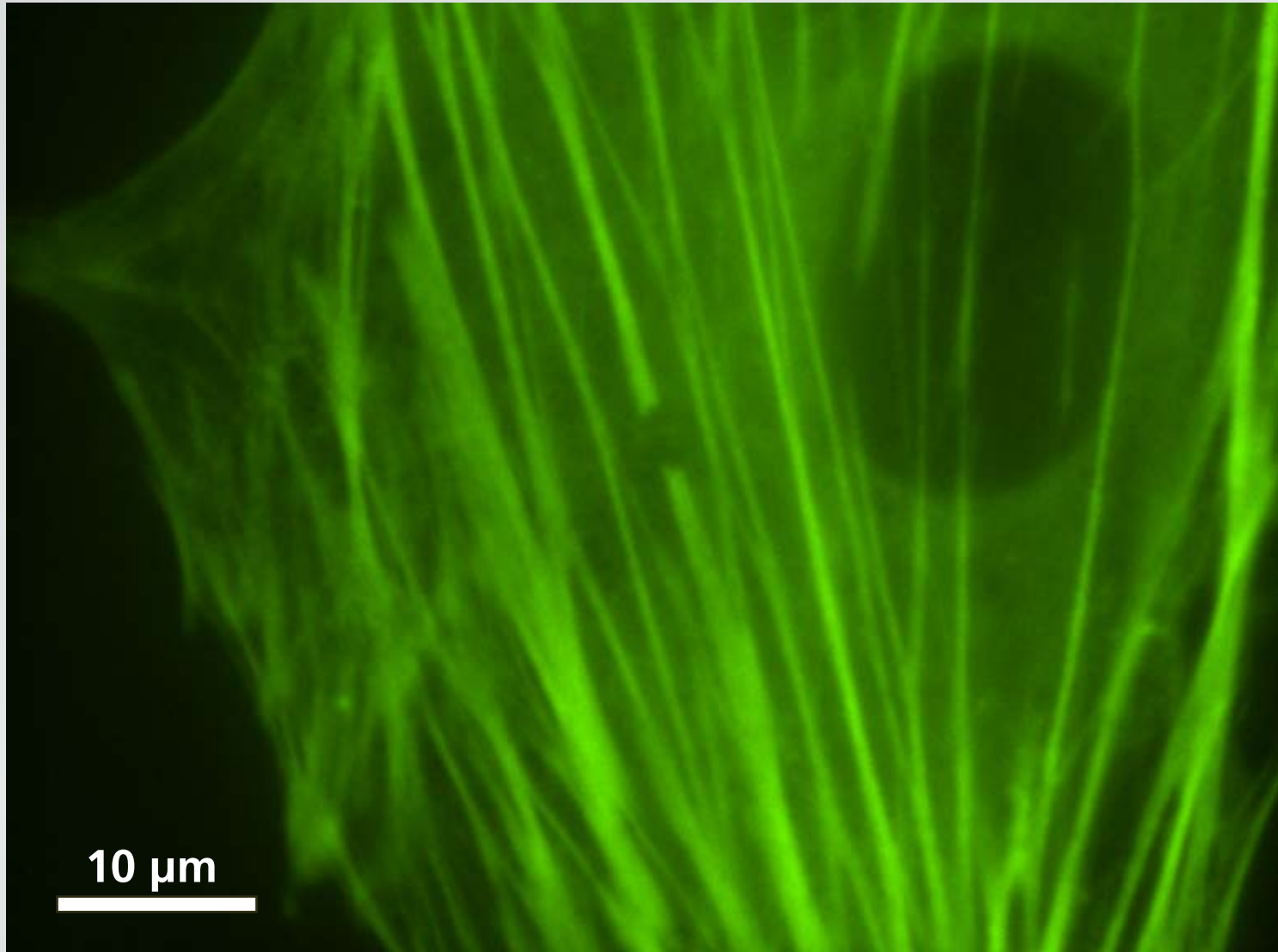

Applications

gap widens with time

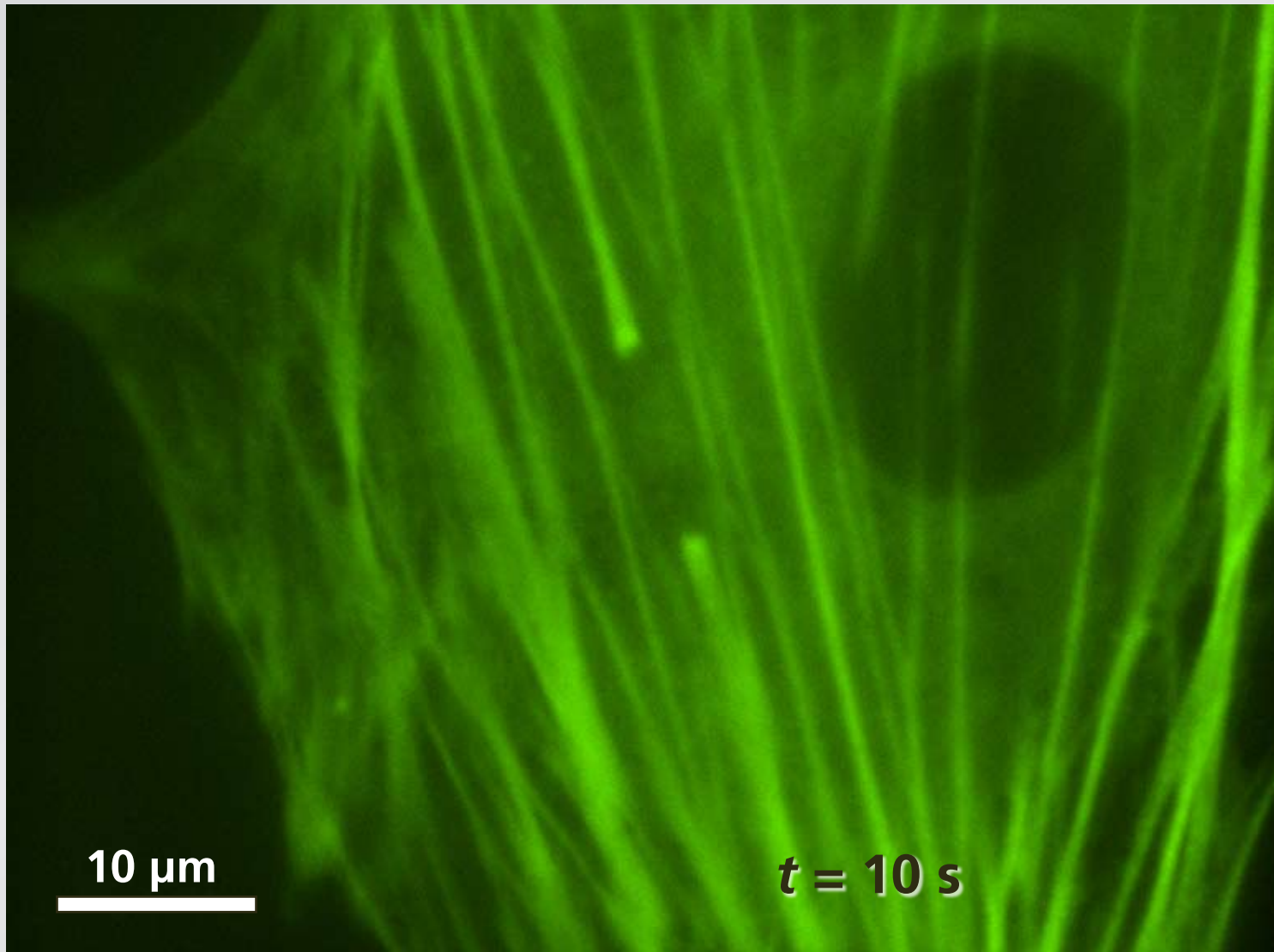

Applications

dynamics provides information on *in vivo* mechanics

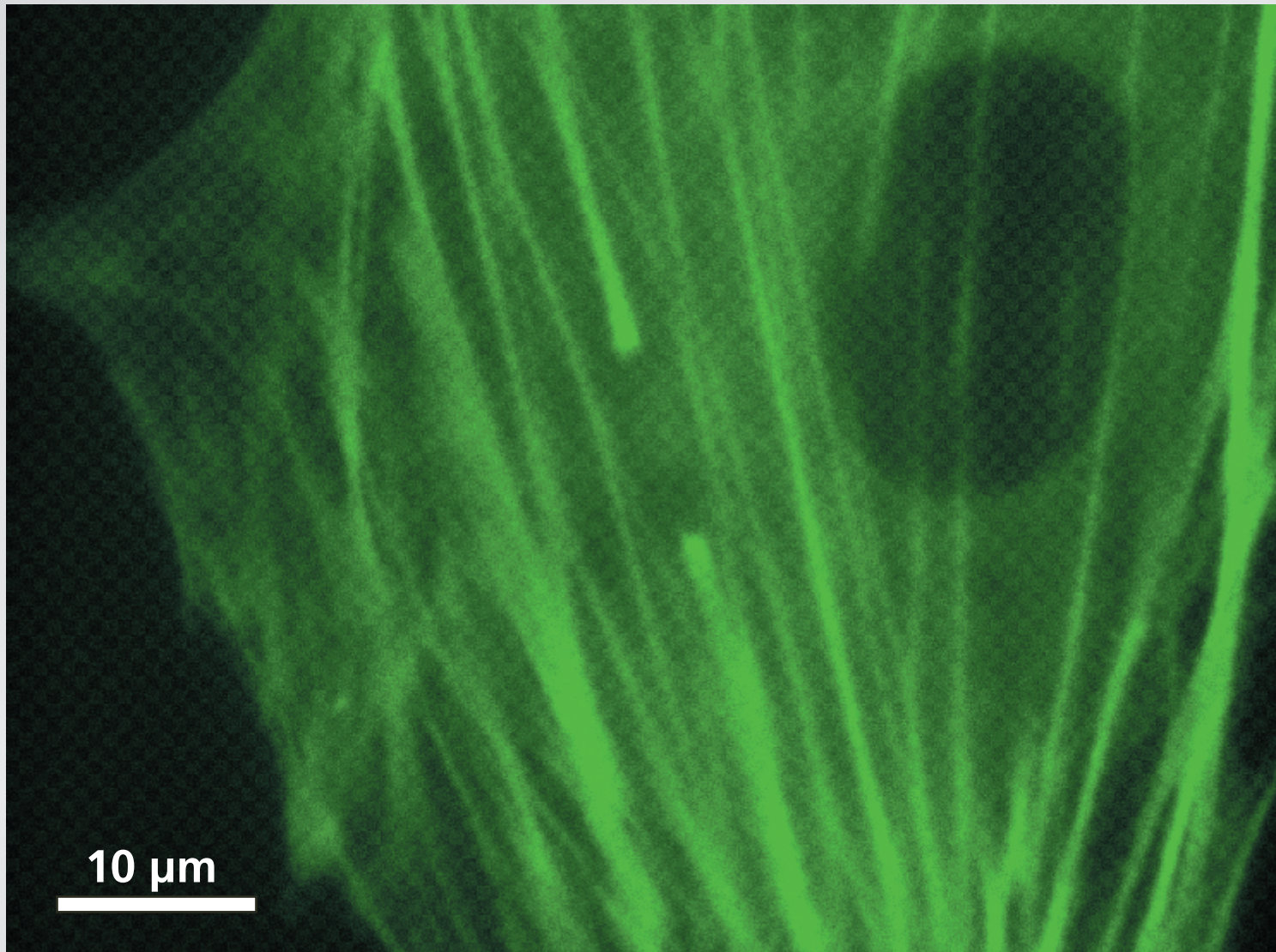

Applications

Q: can we probe the neurological origins of behavior?



Applications

Caenorhabditis Elegans



Juergen Berger & Ralph Sommer
Max-Planck Institute for Developmental Biology

Applications

Caenorhabditis Elegans

- simple model organism
- similarities to higher organisms
- genome fully sequenced
- easy to handle

Applications

Caenorhabditis Elegans

- 80 μm x 1 mm
- about 1300 cells
- 302 neurons
- invariant wiring diagram
- neuronal system completely encodes behavior

Applications

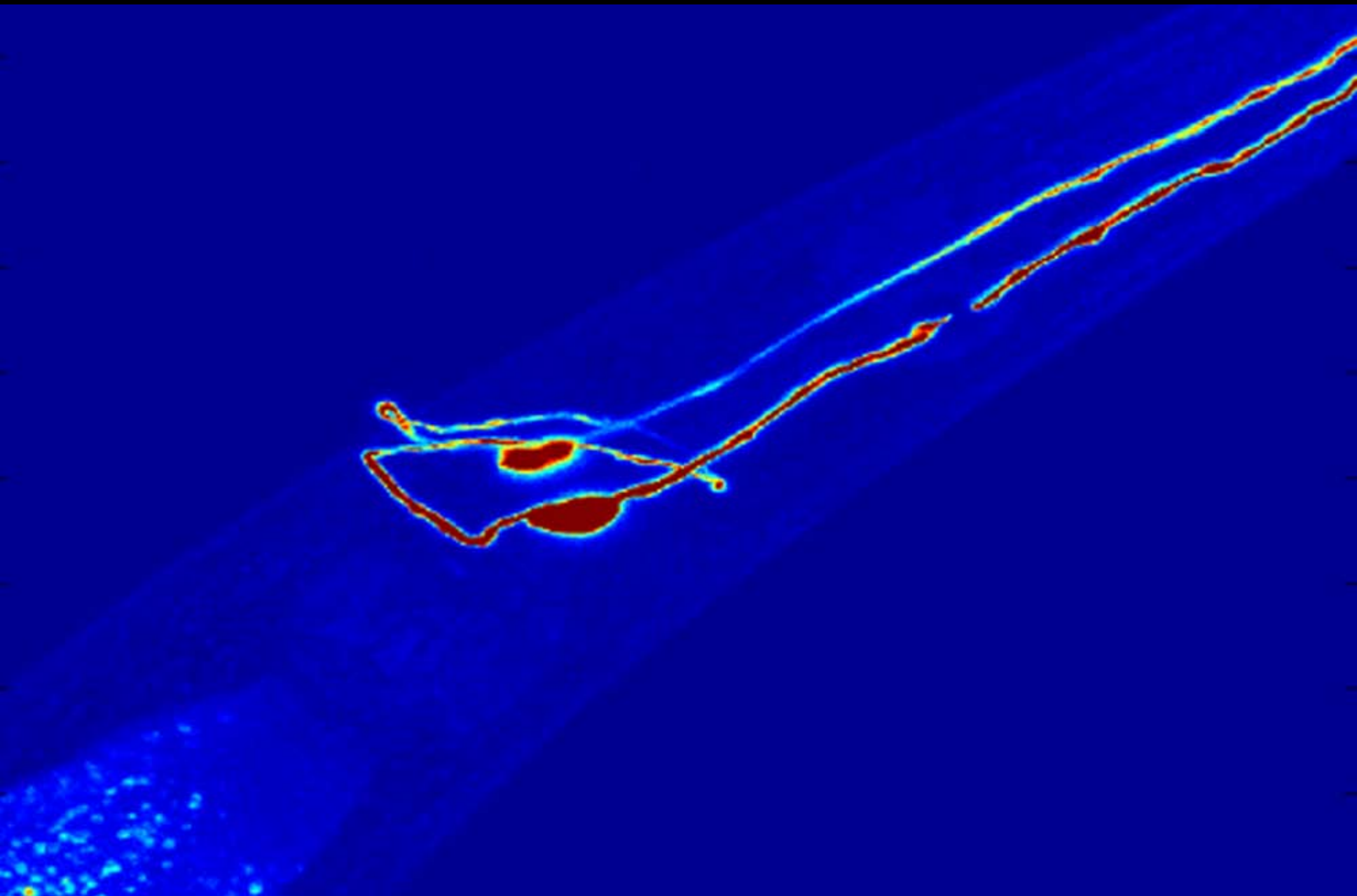

Applications

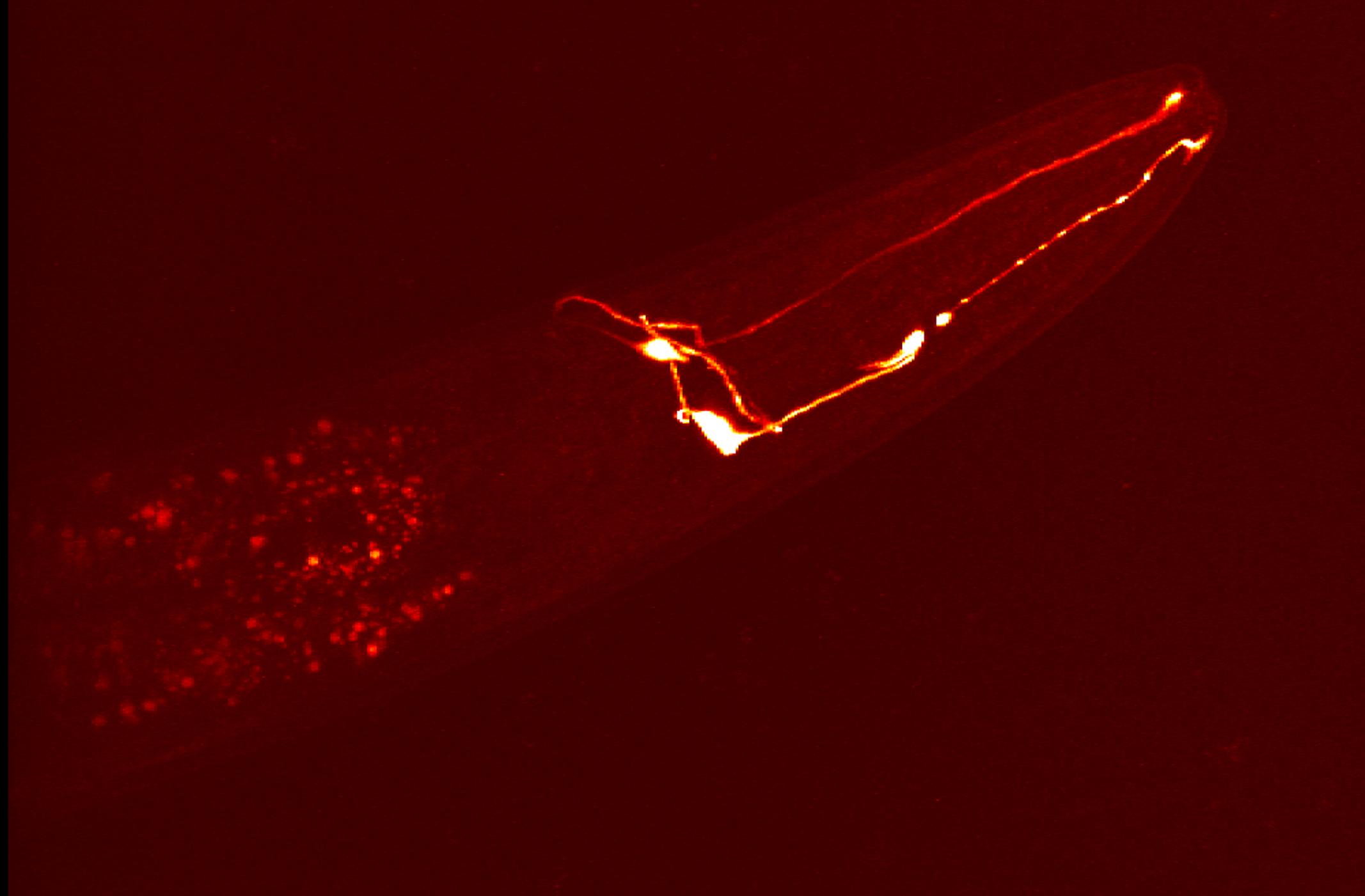

Applications

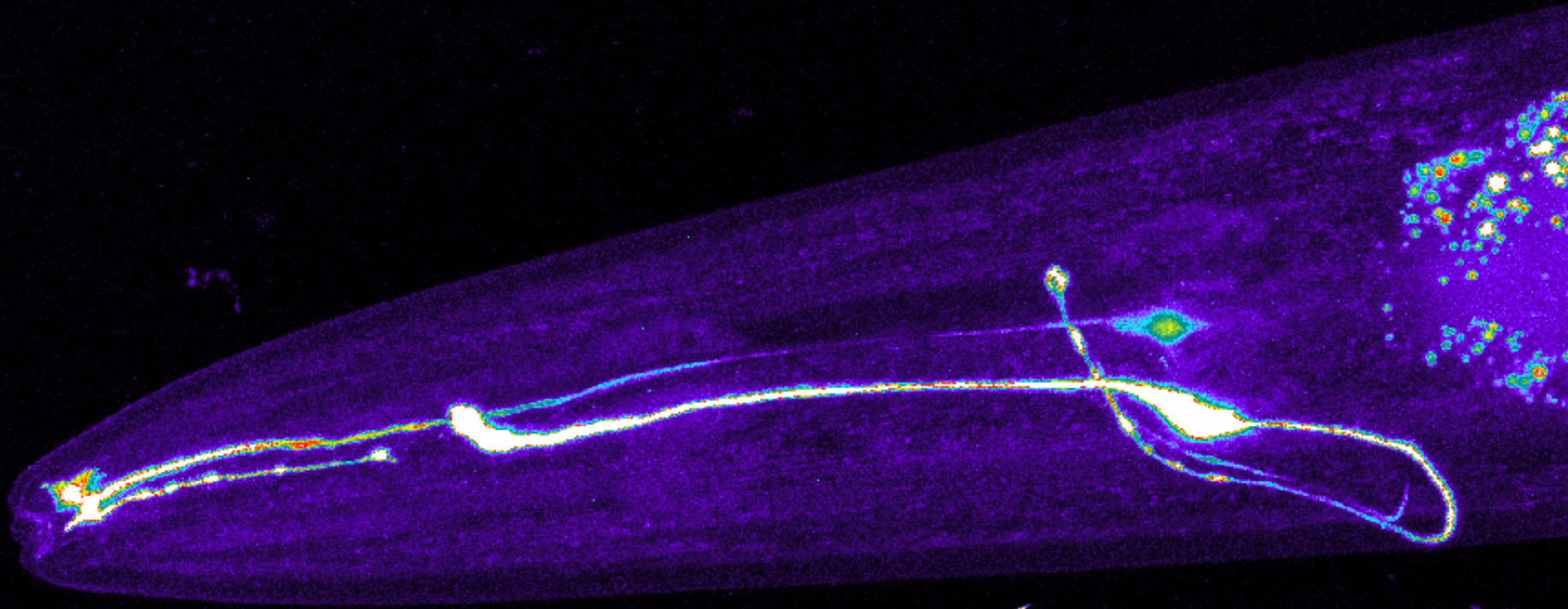

Applications

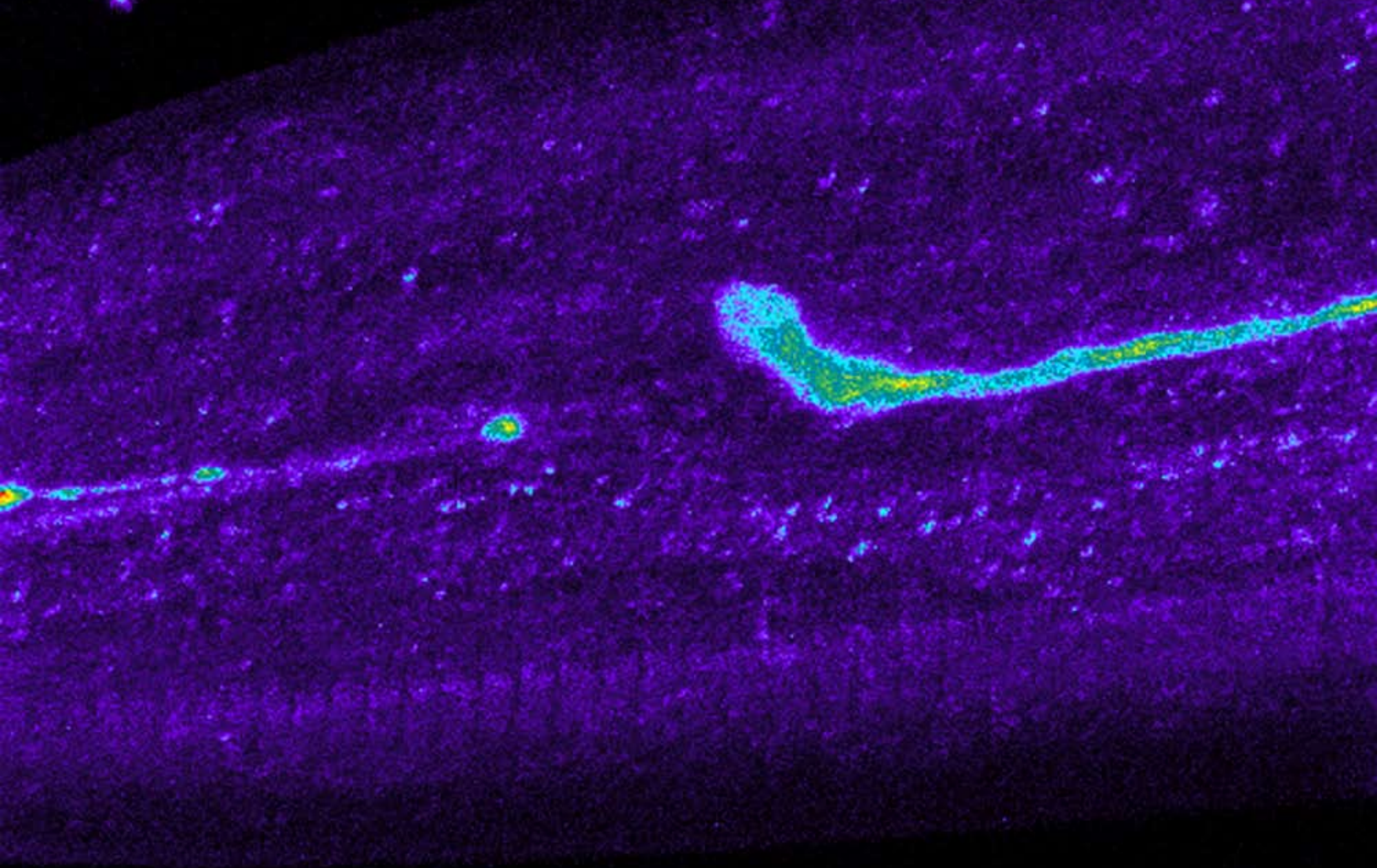

Applications

cut single dendrite in amphid bundle

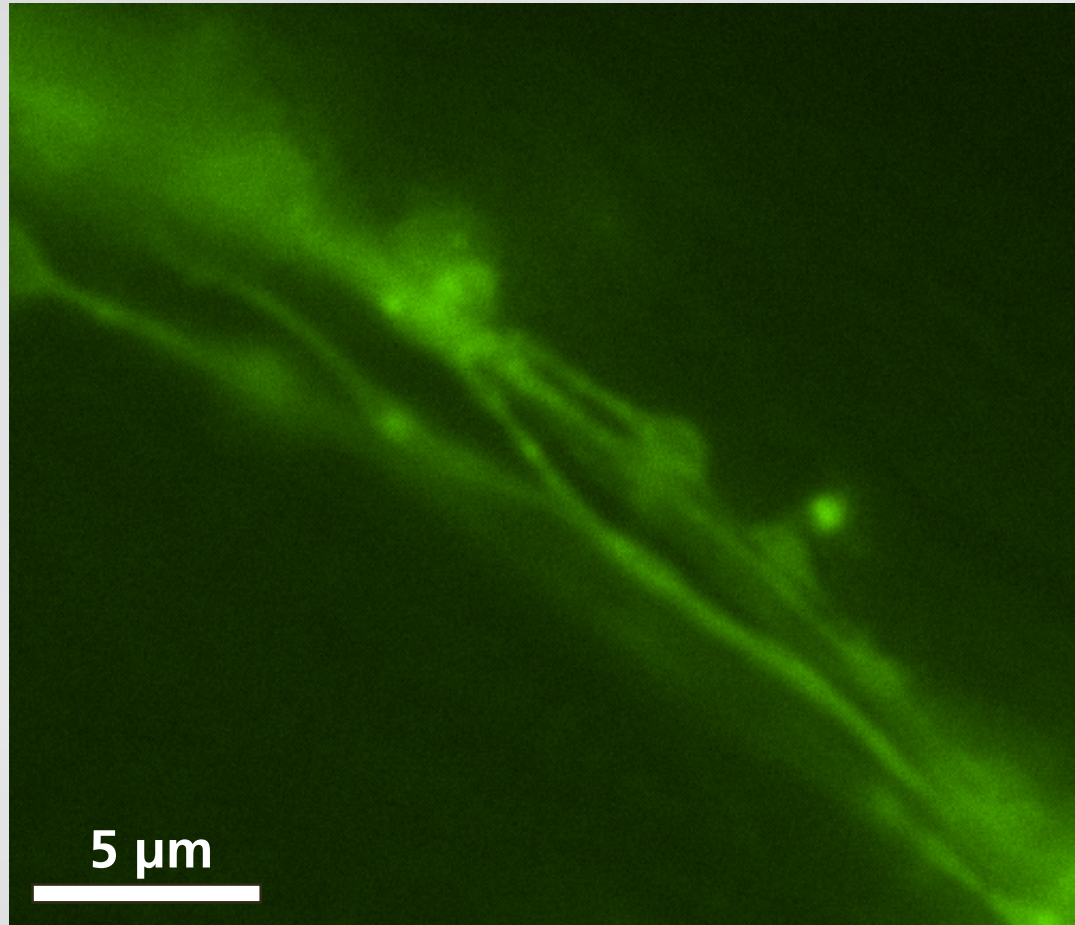

Applications

cut single dendrite in amphid bundle

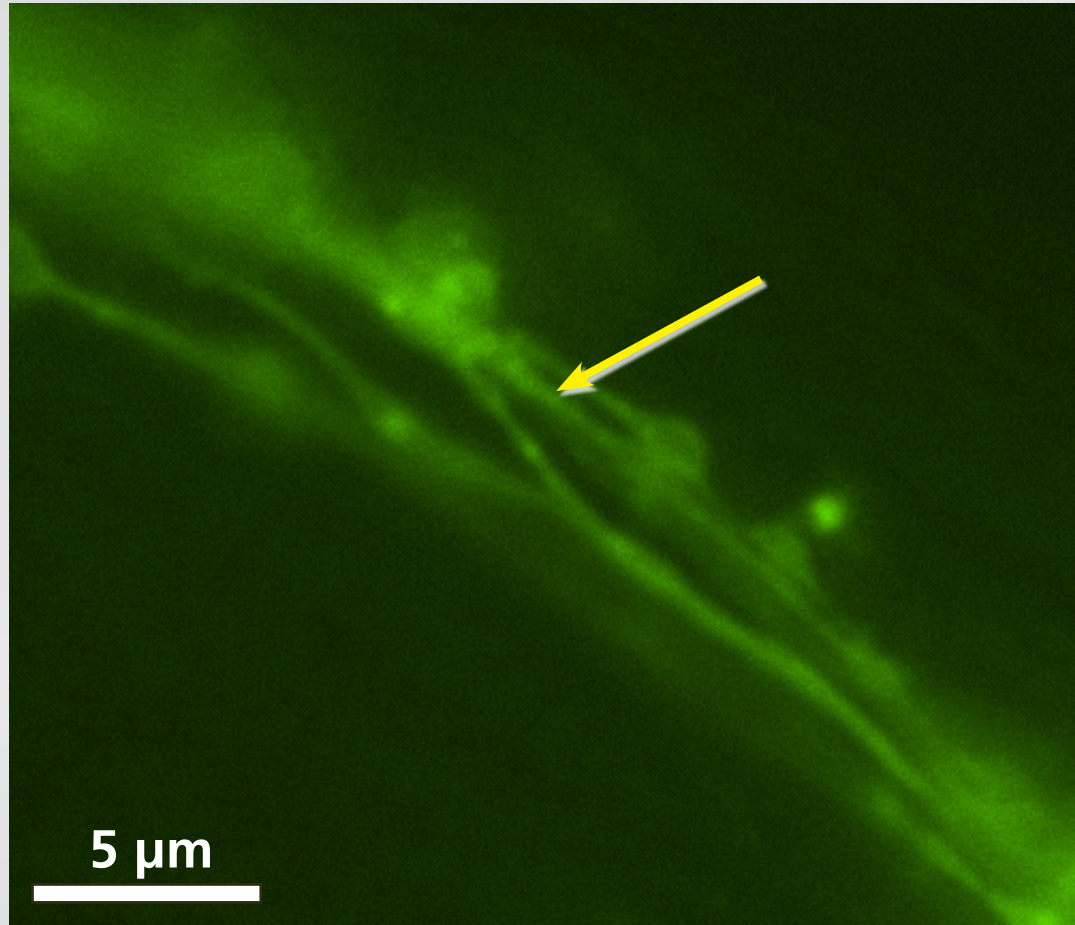

Applications

cut single dendrite in amphid bundle

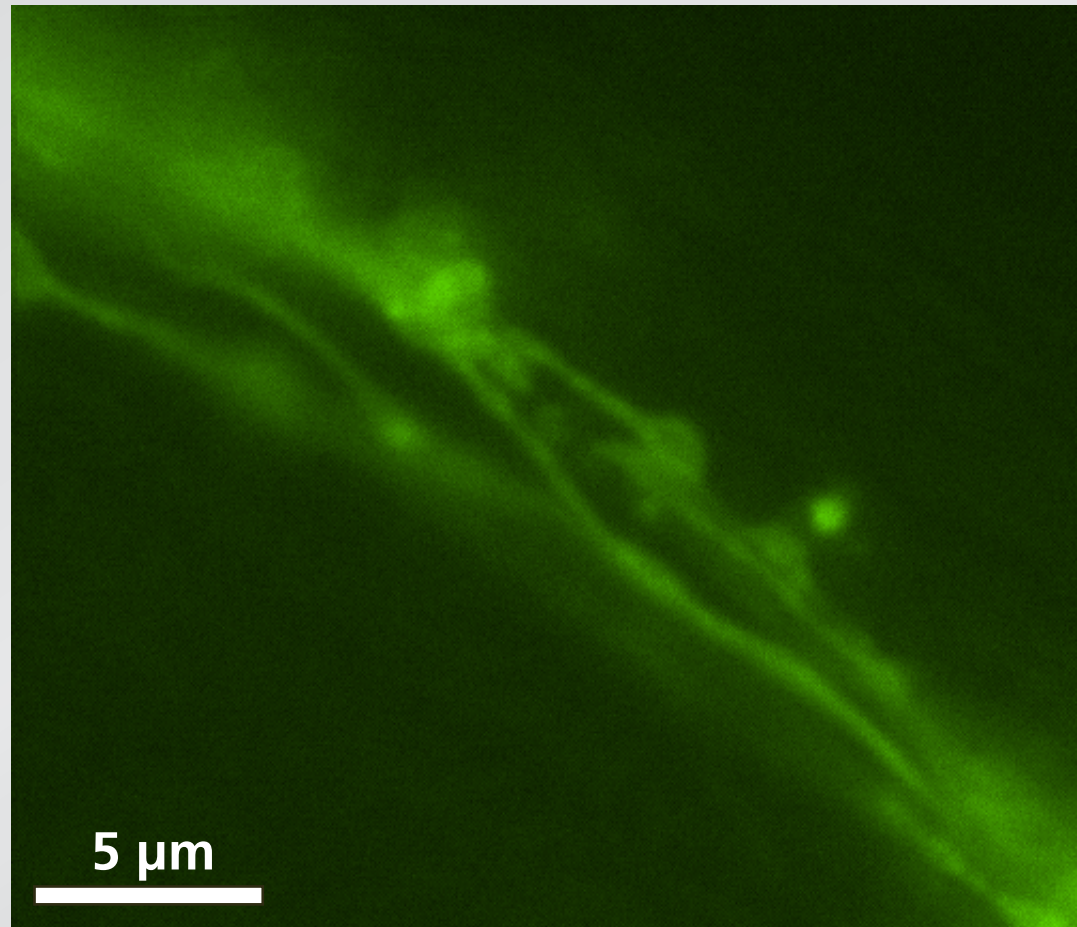

Applications

surgery results in quantifiable behavior changes

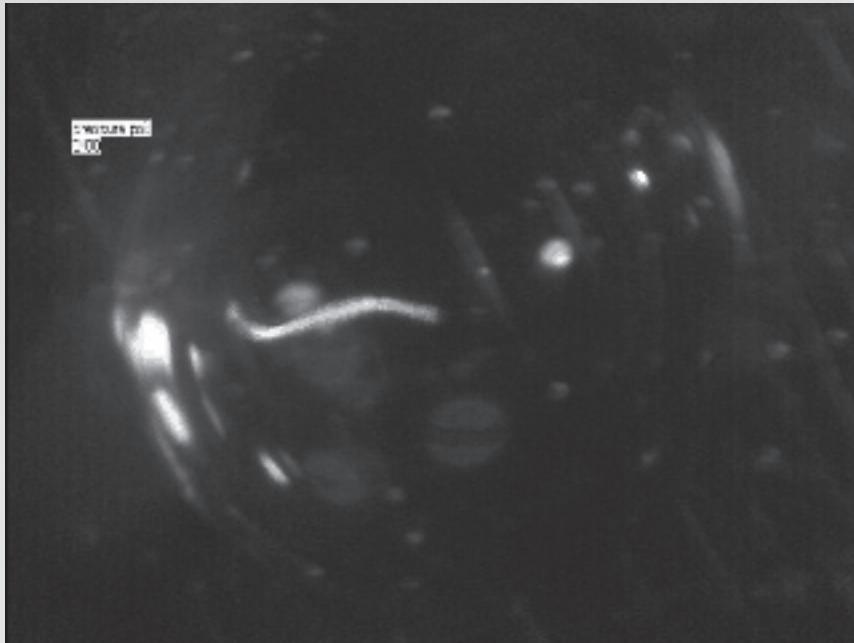

before

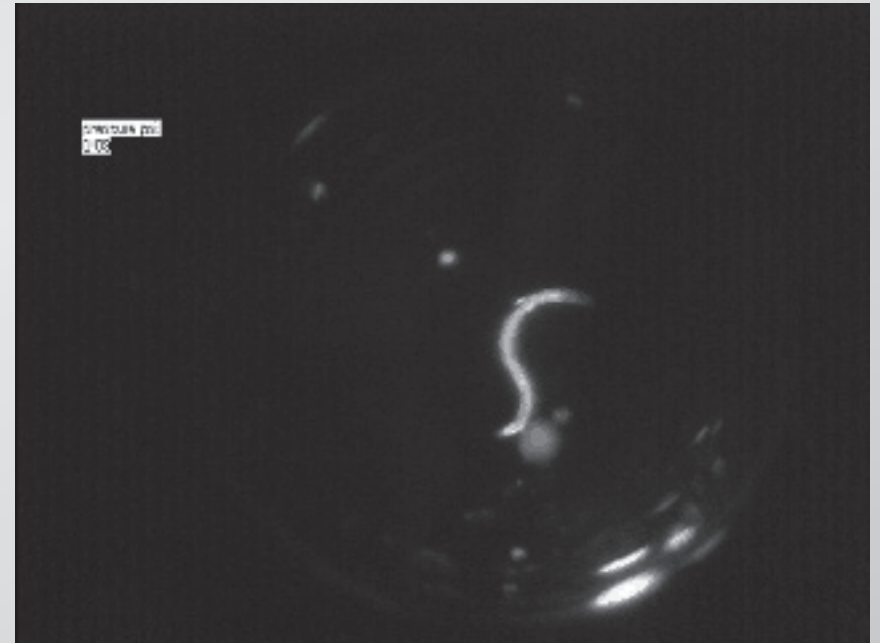

after

Summary

great tool for

- "wiring light"
- micromanipulating the machinery of life

Summary

- **important parameters: focusing, energy, repetition rate**
- **nearly material independent**
- **two regimes: low and high repetition rate**
- **high-repetition rate (thermal) machining fast, convenient**



Funding:

**Army Research Office
National Science Foundation**

for a copy of this presentation:

<http://mazur-www.harvard.edu>



Google™

Google Search

I'm Feeling Lucky

Google™

mazur

Google Search

I'm Feeling Lucky

Google™

Google Search

I'm Feeling Lucky

Google™

Google Search

I'm Feeling Lucky

Funding:

**Army Research Office
National Science Foundation**

for a copy of this presentation:

<http://mazur-www.harvard.edu>

