

Wrapping light around a hair

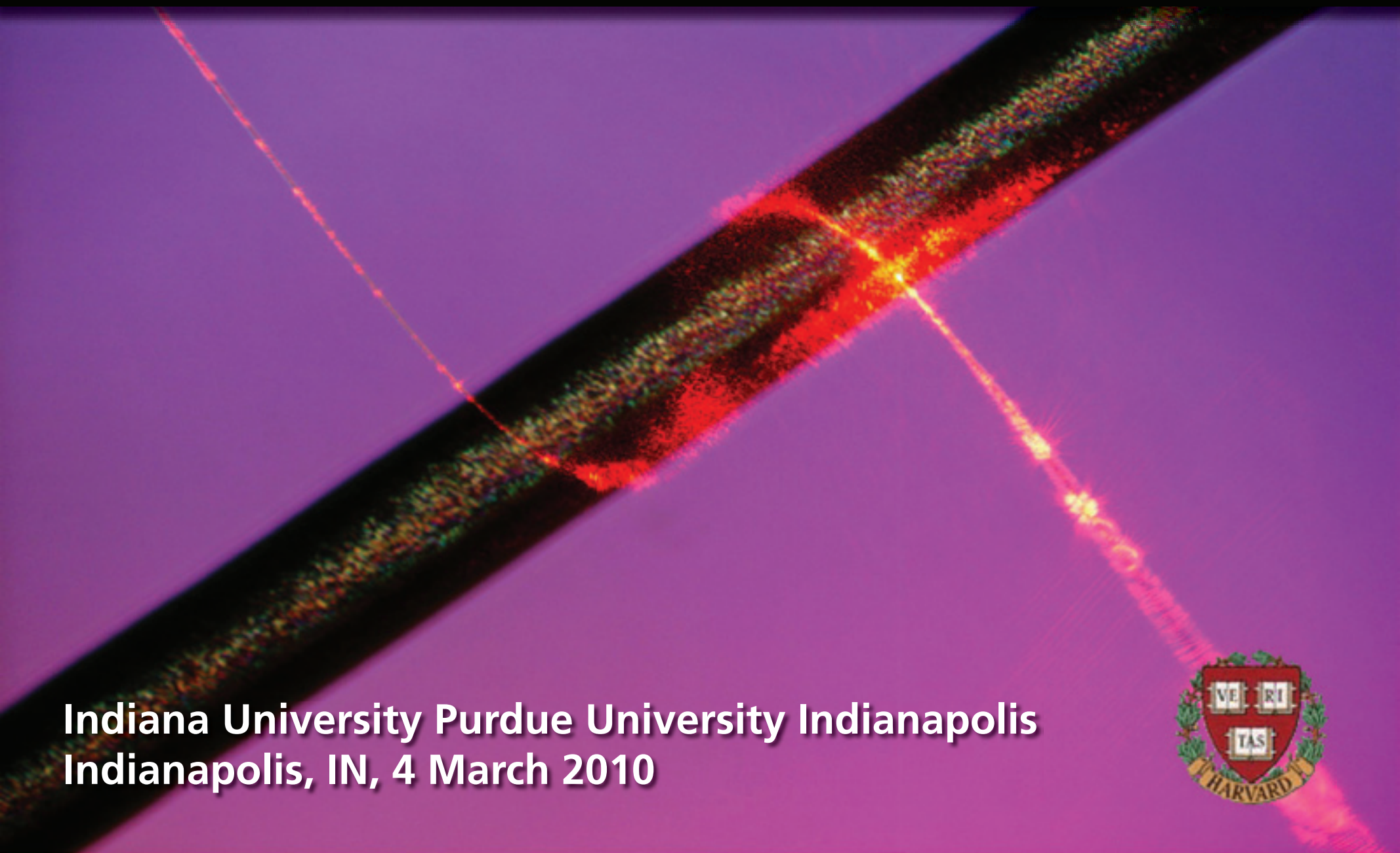

Indiana University Purdue University Indianapolis
Indianapolis, IN, 4 March 2010





Rafael Gattass



Geoff Svacha

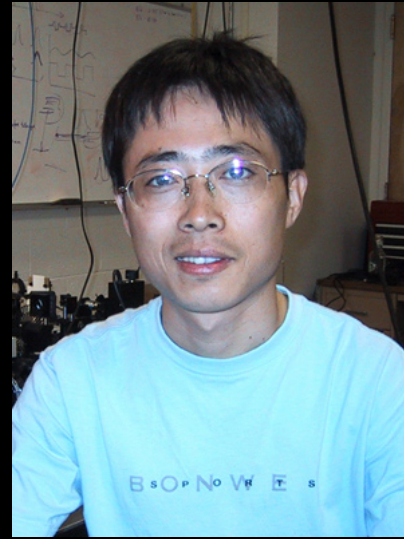

Limin Tong



Tobias Voss

and also....

Jonathan Aschom

Mengyan Shen

Iva Maxwell

James Carey

Brian Tull

Dr. Yuan Lu

Dr. Richard Schalek

Prof. Federico Capasso

Prof. Cynthia Friend

Xuwen Chen (Zhejiang)

Zhanghua Han (Zhejiang)

Dr. Sailing He (Zhejiang)

Liu Liu (Zhejiang)

Dr. Jingyi Lou (Zhejiang)

Dr. Ray Mariella (LLNL)

Prof. Frank Marlow (MPI Mülheim)

Prof. Sven Müller (Göttingen)

Prof. Carsten Ronning (Göttingen)

“I managed to illuminate the interior of a stream in a dark space. I have discovered that this strange arrangement offers one of the most beautiful, and most curious experiments that one can perform in a course on Optics.”

Daniel Colladon, *Comptes Rendus*, 15, 800–802 (1842)

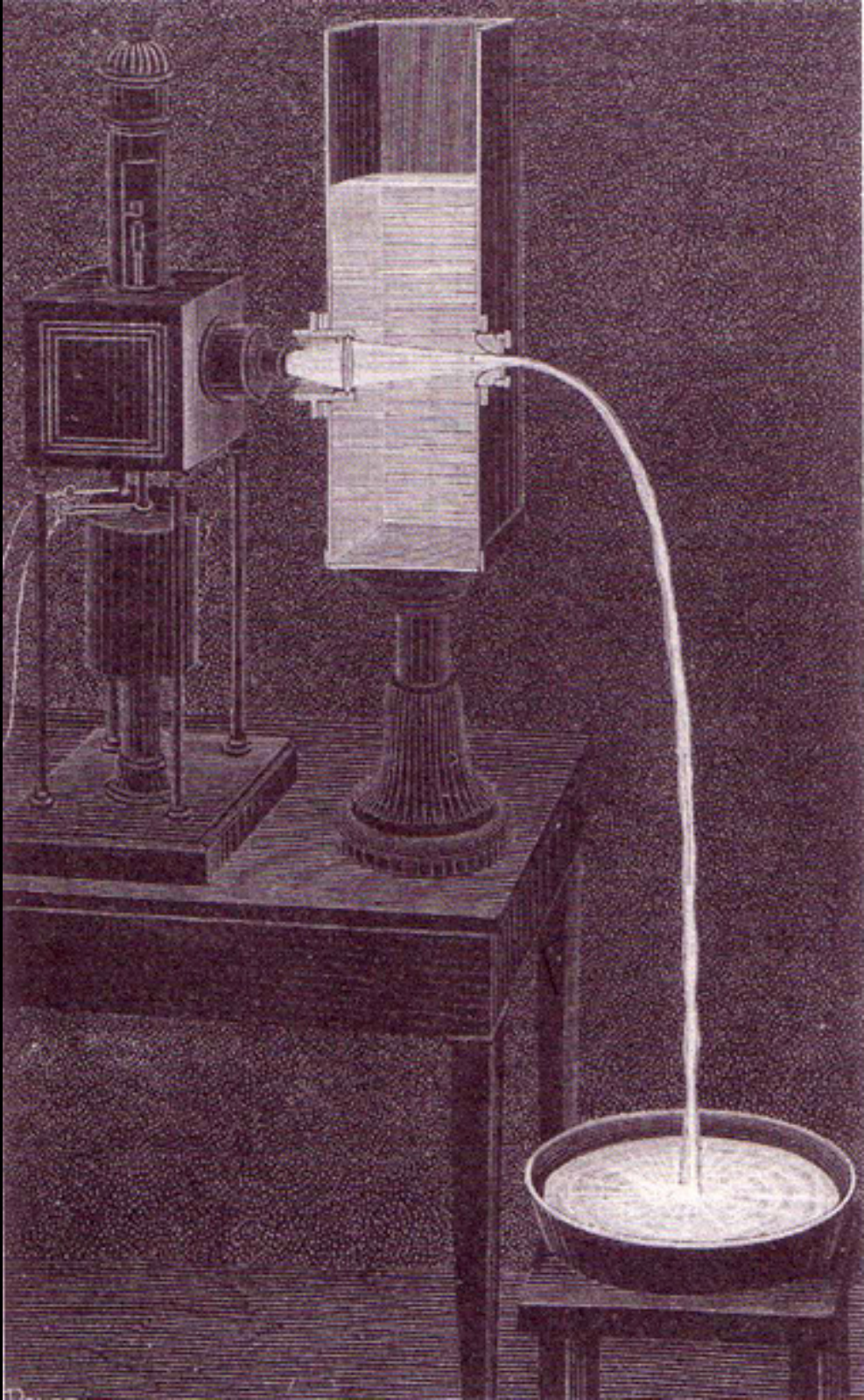

D. Colladon, *La Nature*, 325 (1884)



W. WHEELER.

APPARATUS FOR LIGHTING DWELLINGS OR OTHER STRUCTURES.

No. 247,229.

Patented Sept. 20, 1881.

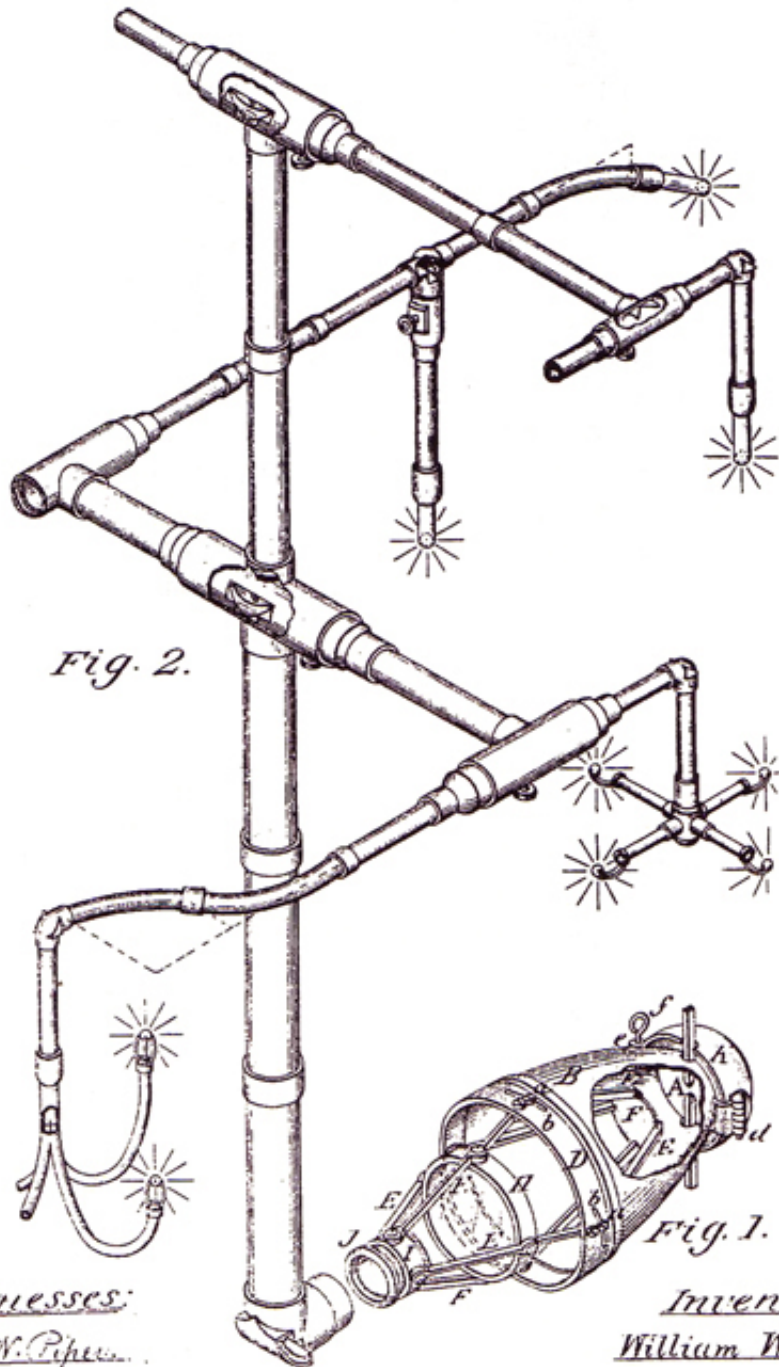

Fig. 2.

Fig. 1.

Witnesses:
J. N. Piper
E. L. [unclear]

Inventor:
William Wheeler
 by attorney
[unclear]

US Patent 247, 229 (1881)

Outline

- waveguiding
- silica nanowires
- manipulating light at the nanoscale
- nanoscale nonlinear optics

Waveguiding

two crossed planar waves...

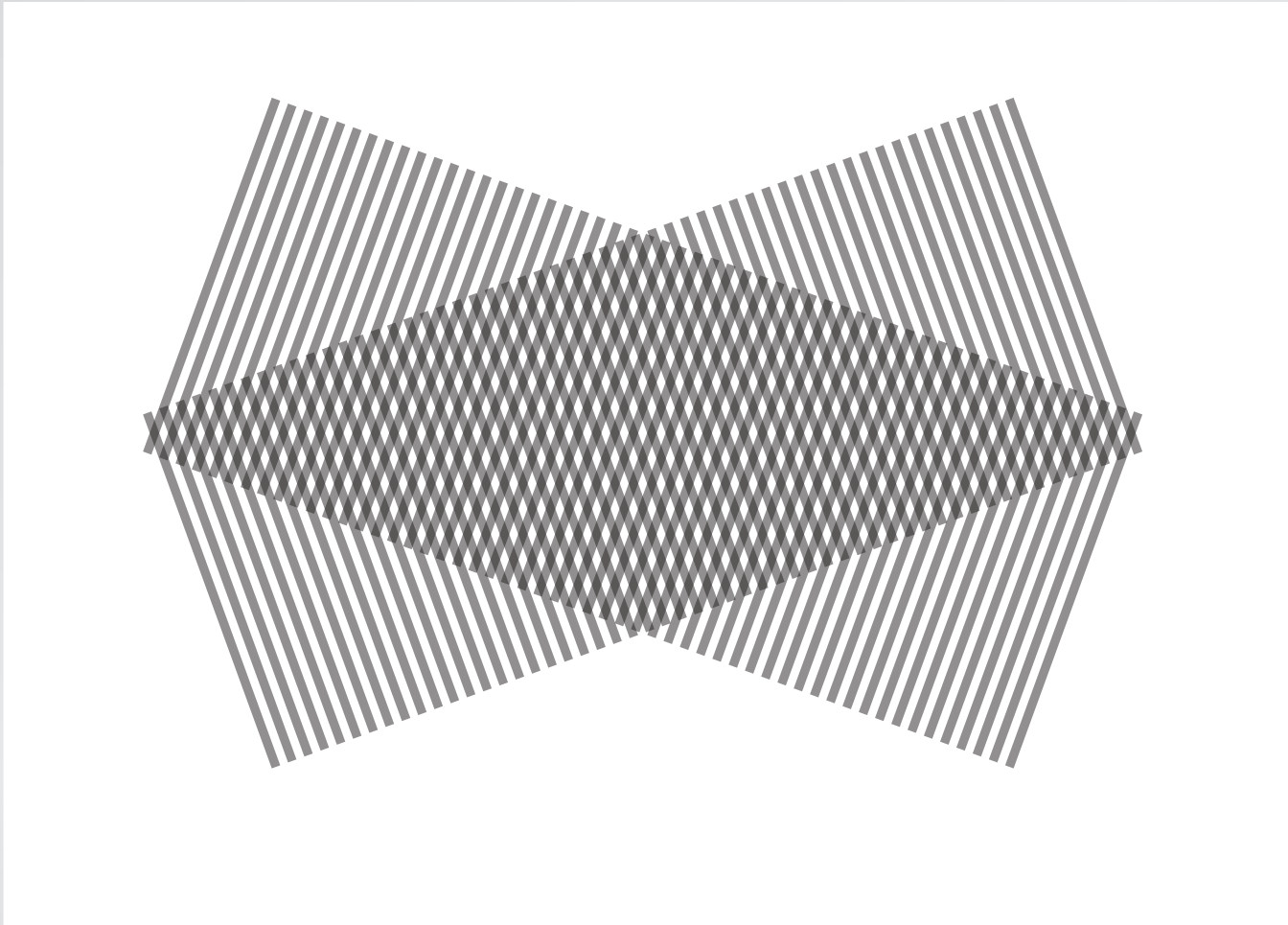

Waveguiding

...cause an interference pattern

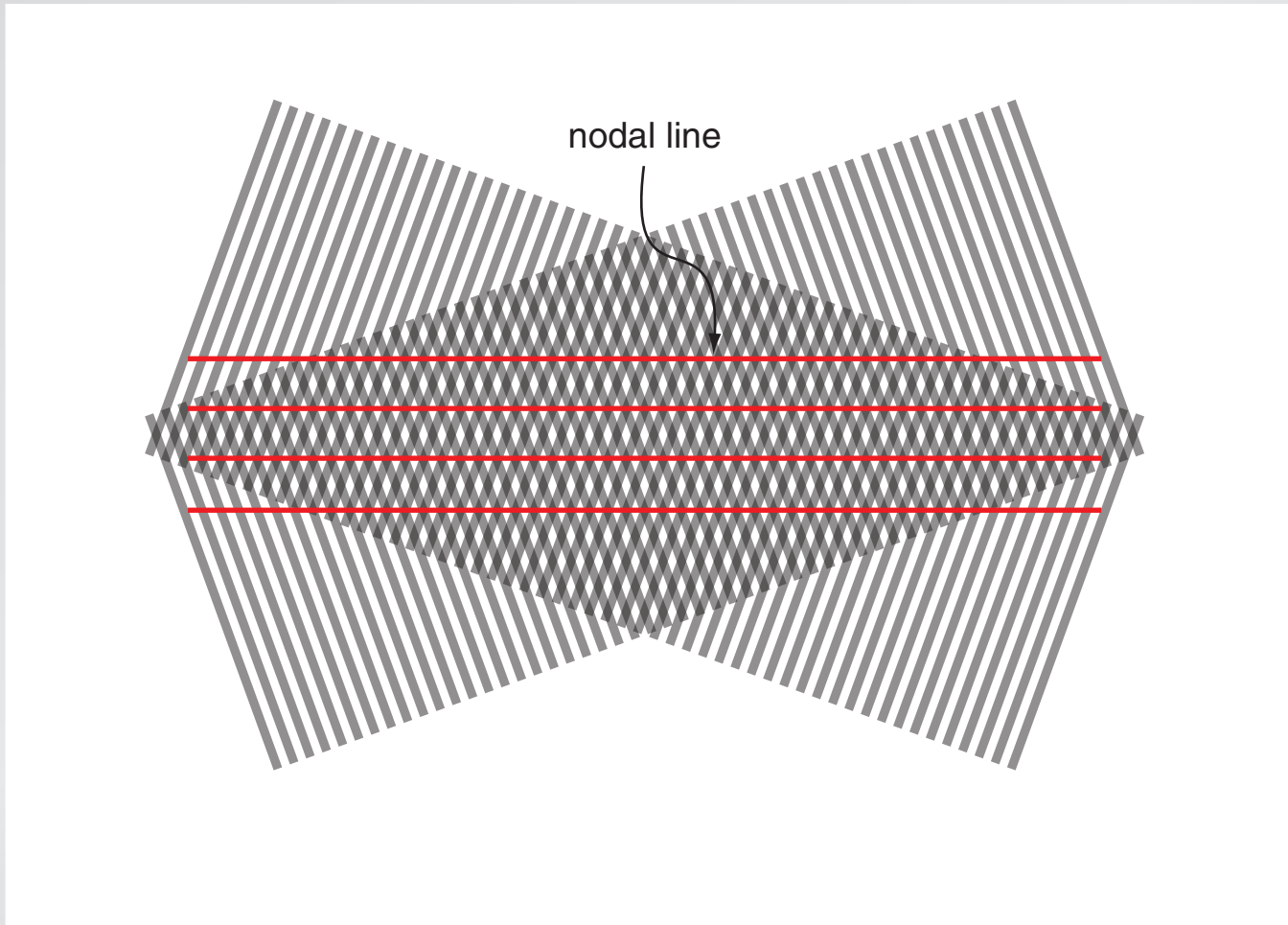

Waveguiding

$E = 0$ on the nodal lines

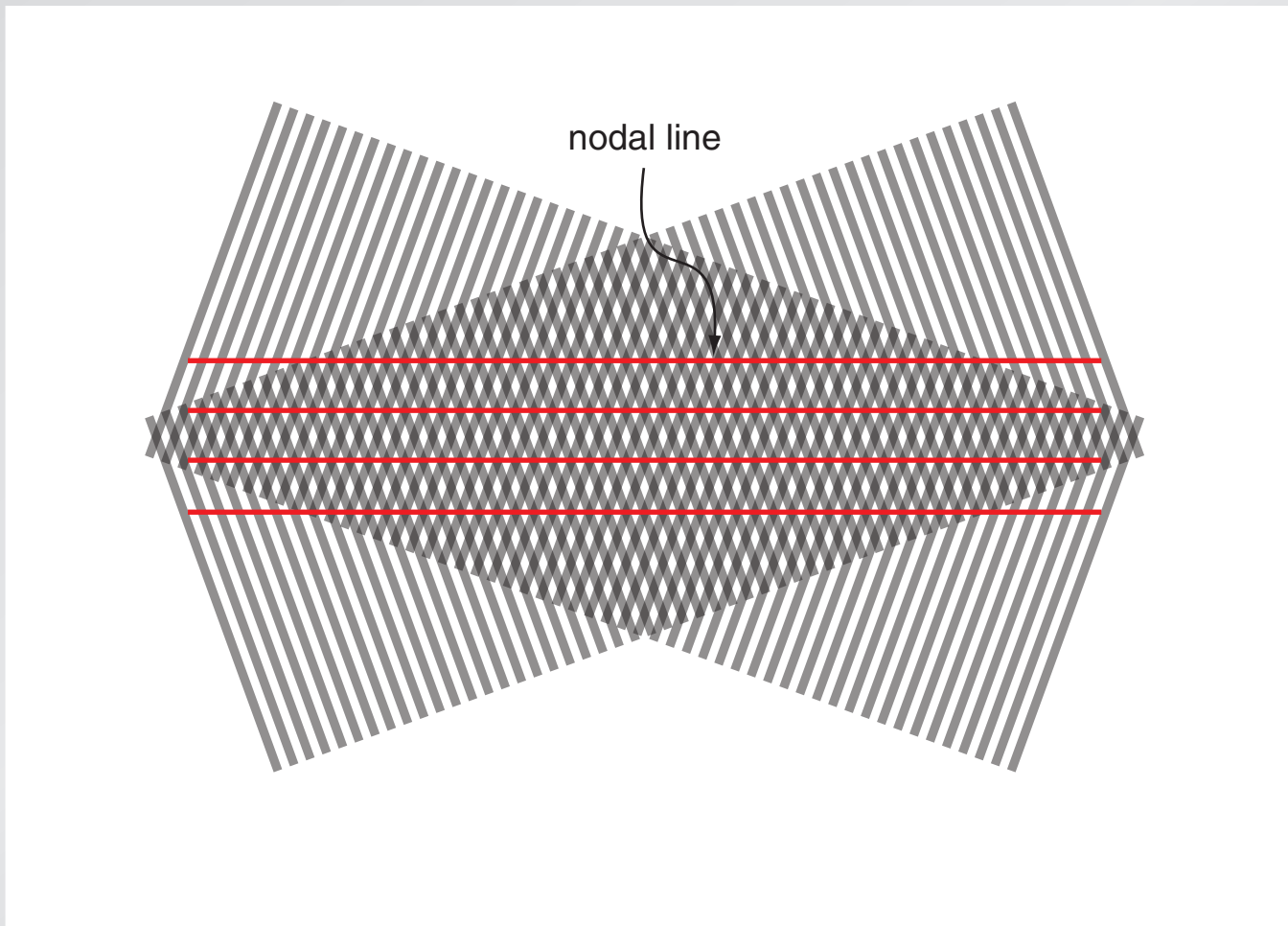

Waveguiding

...satisfying boundary conditions for planar-mirror waveguide

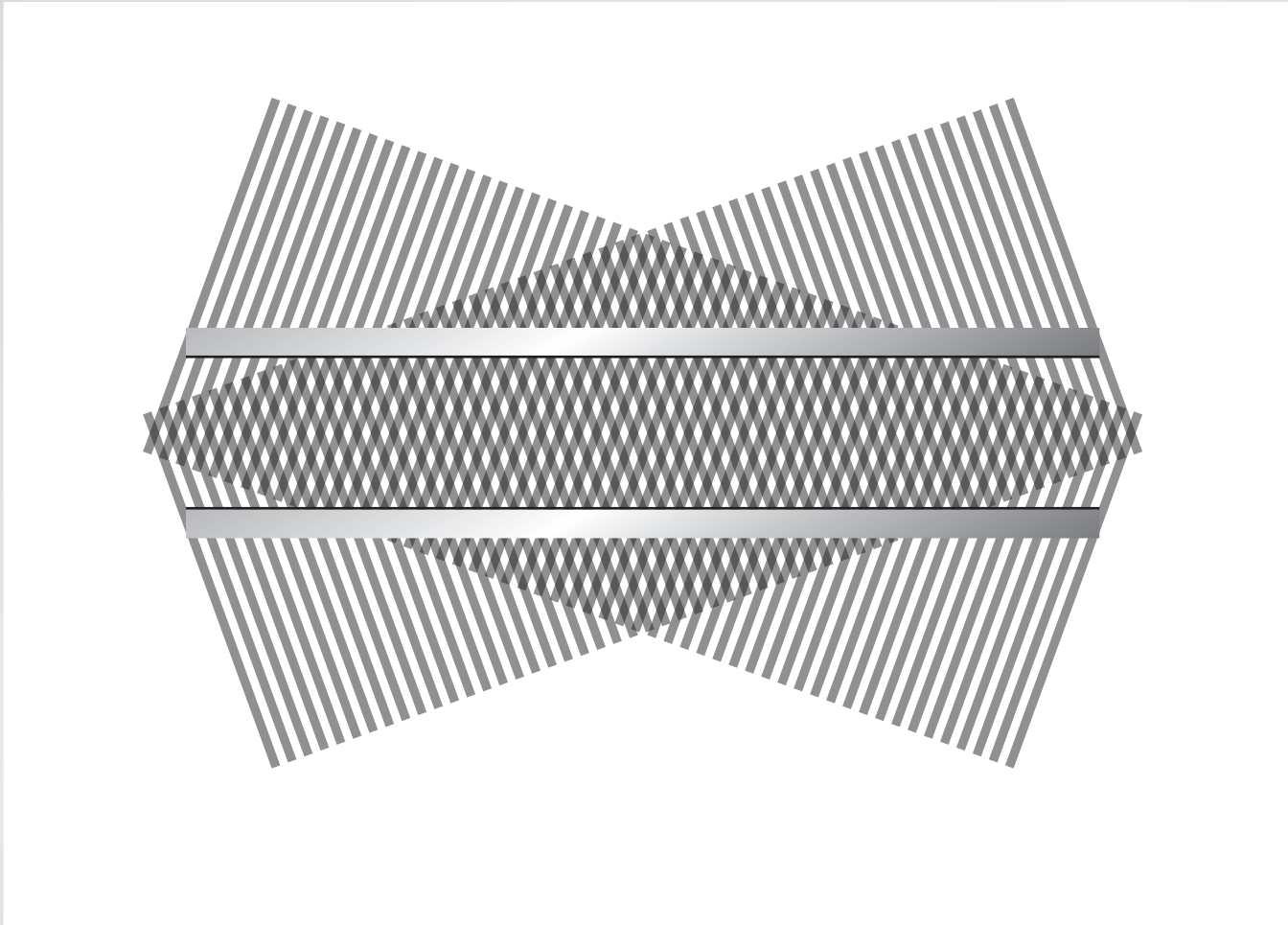

Waveguiding

transverse standing wave, traveling along axis

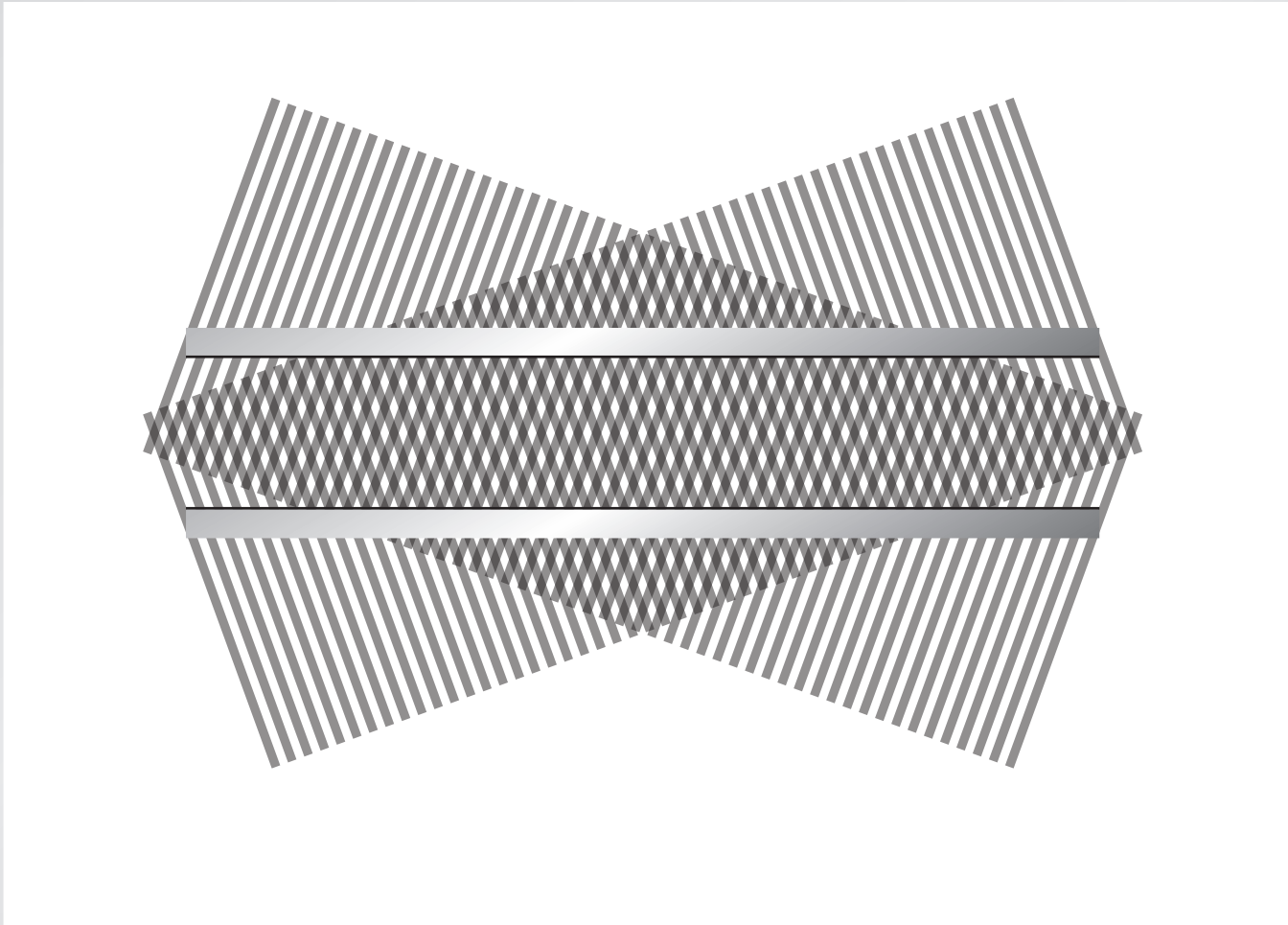

Waveguiding

transverse standing wave, traveling along axis

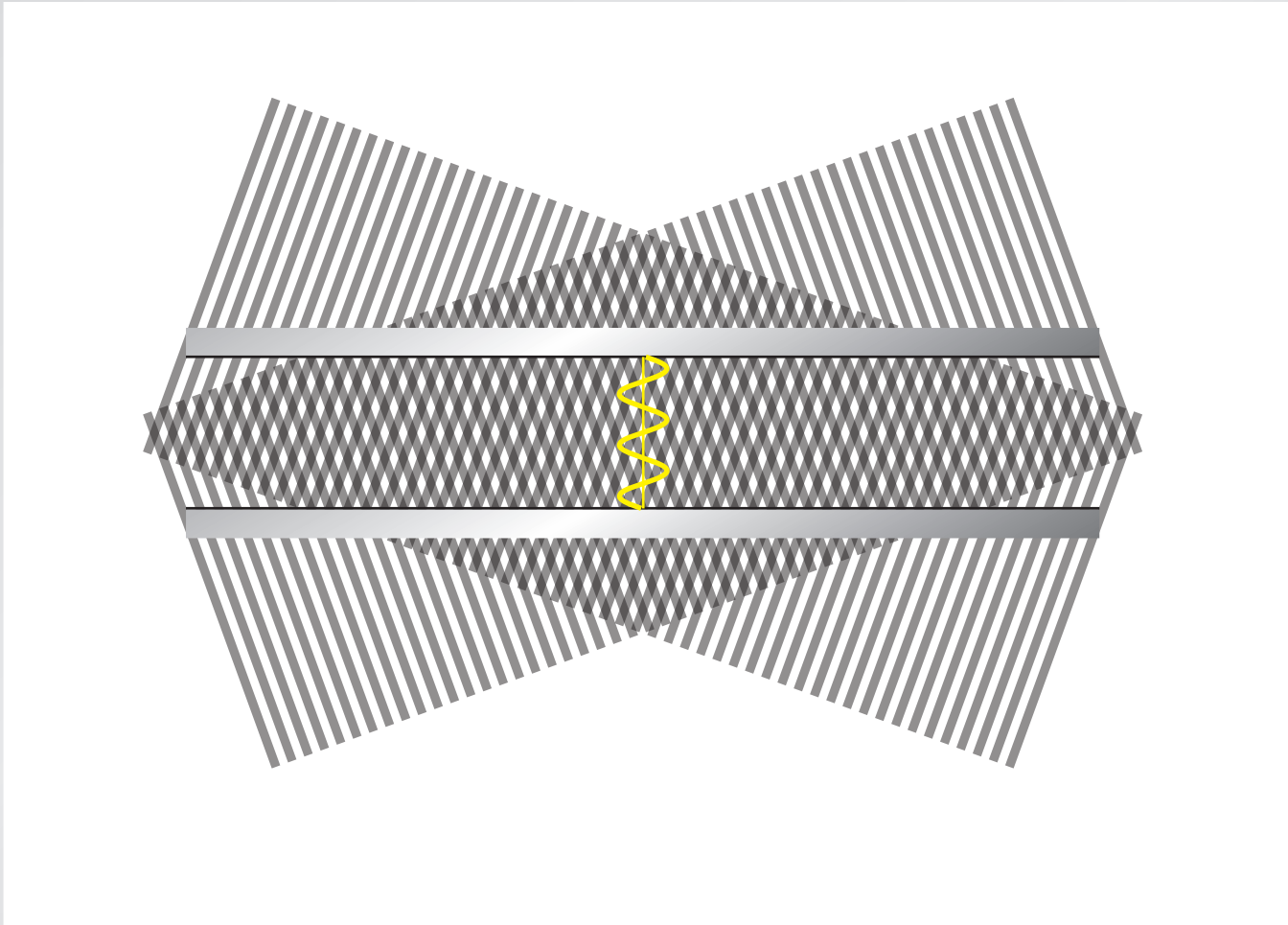

Waveguiding

change angle of incident waves...

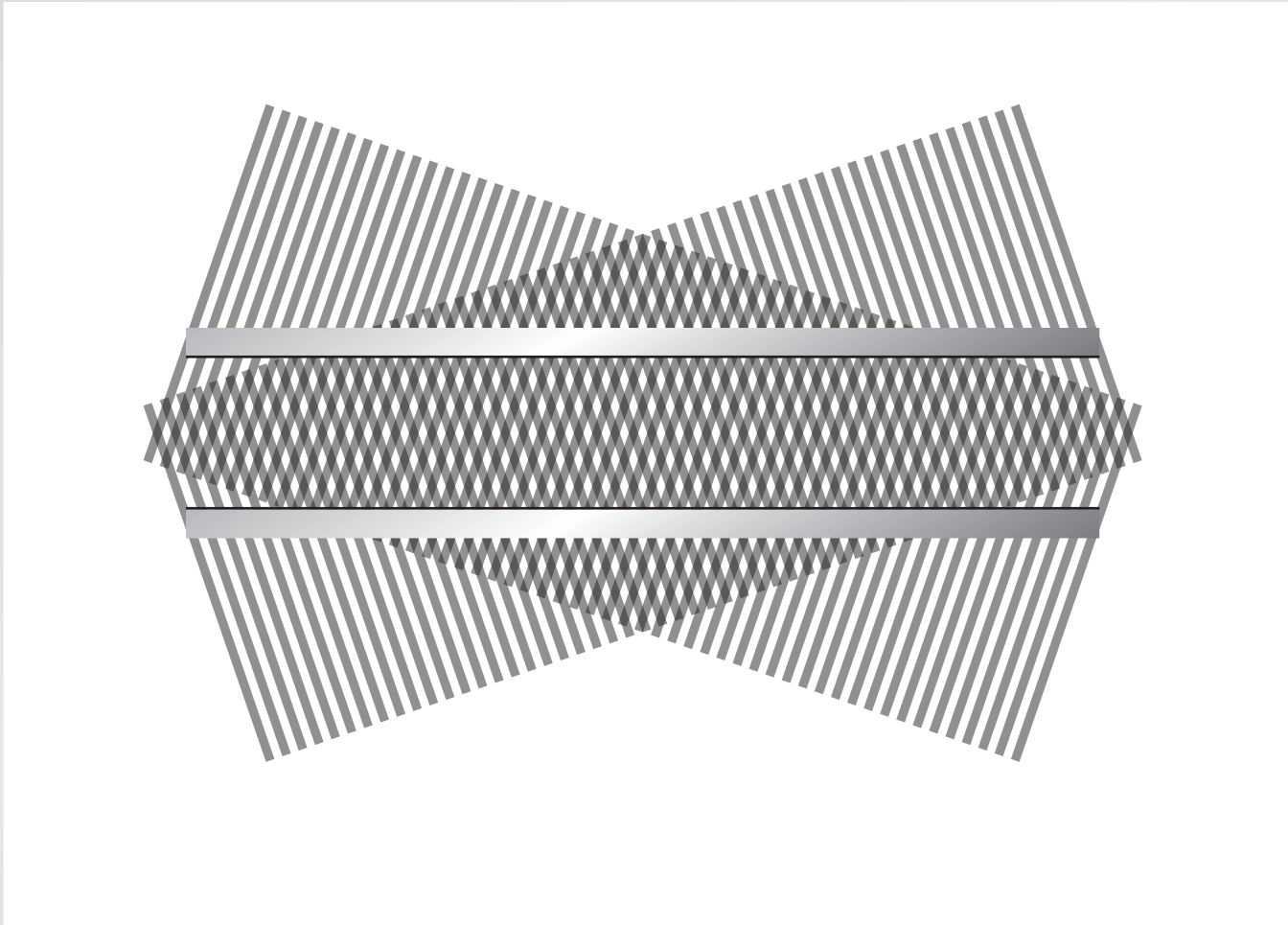

Waveguiding

change angle of incident waves...

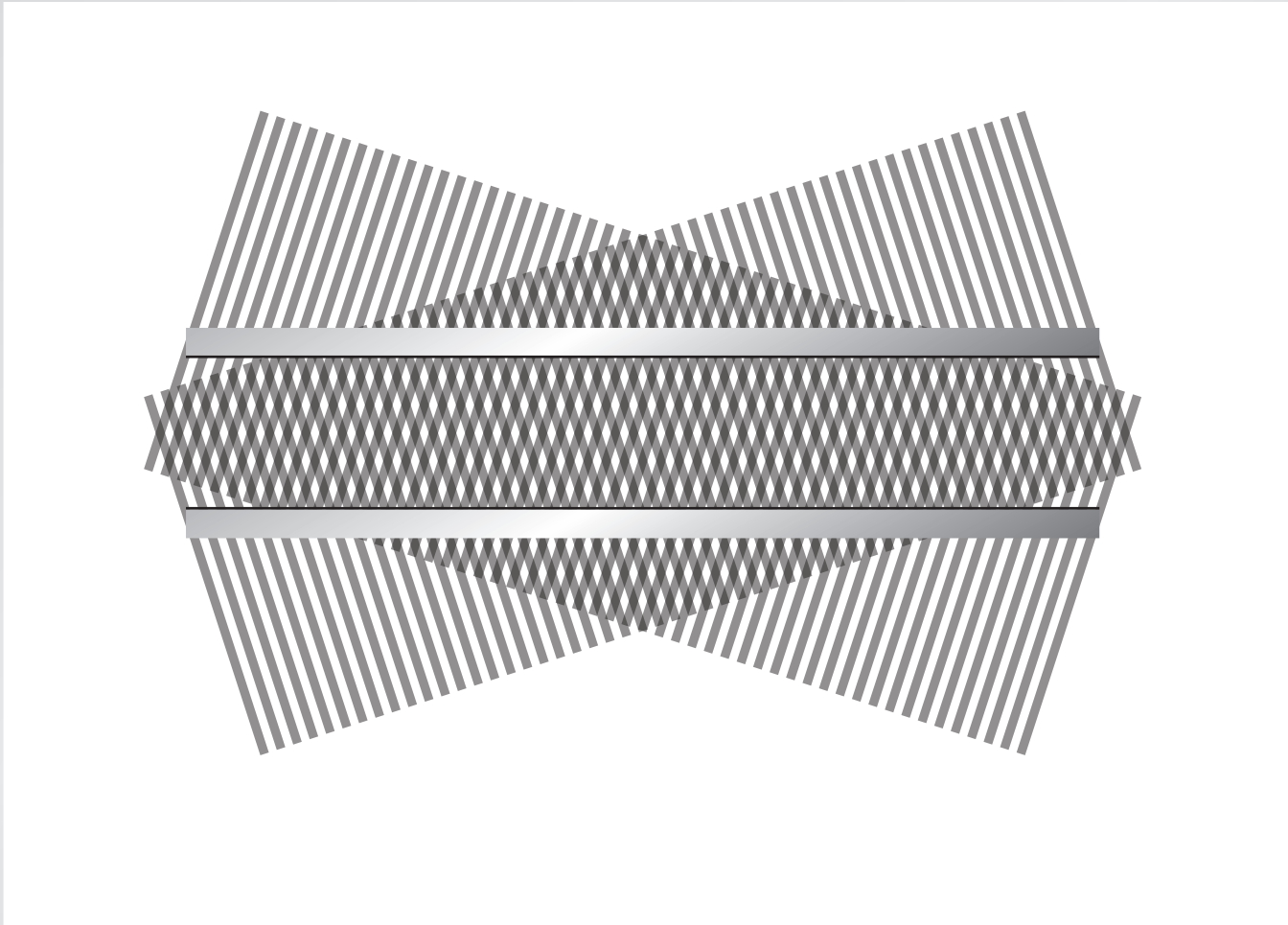

Waveguiding

change angle of incident waves...

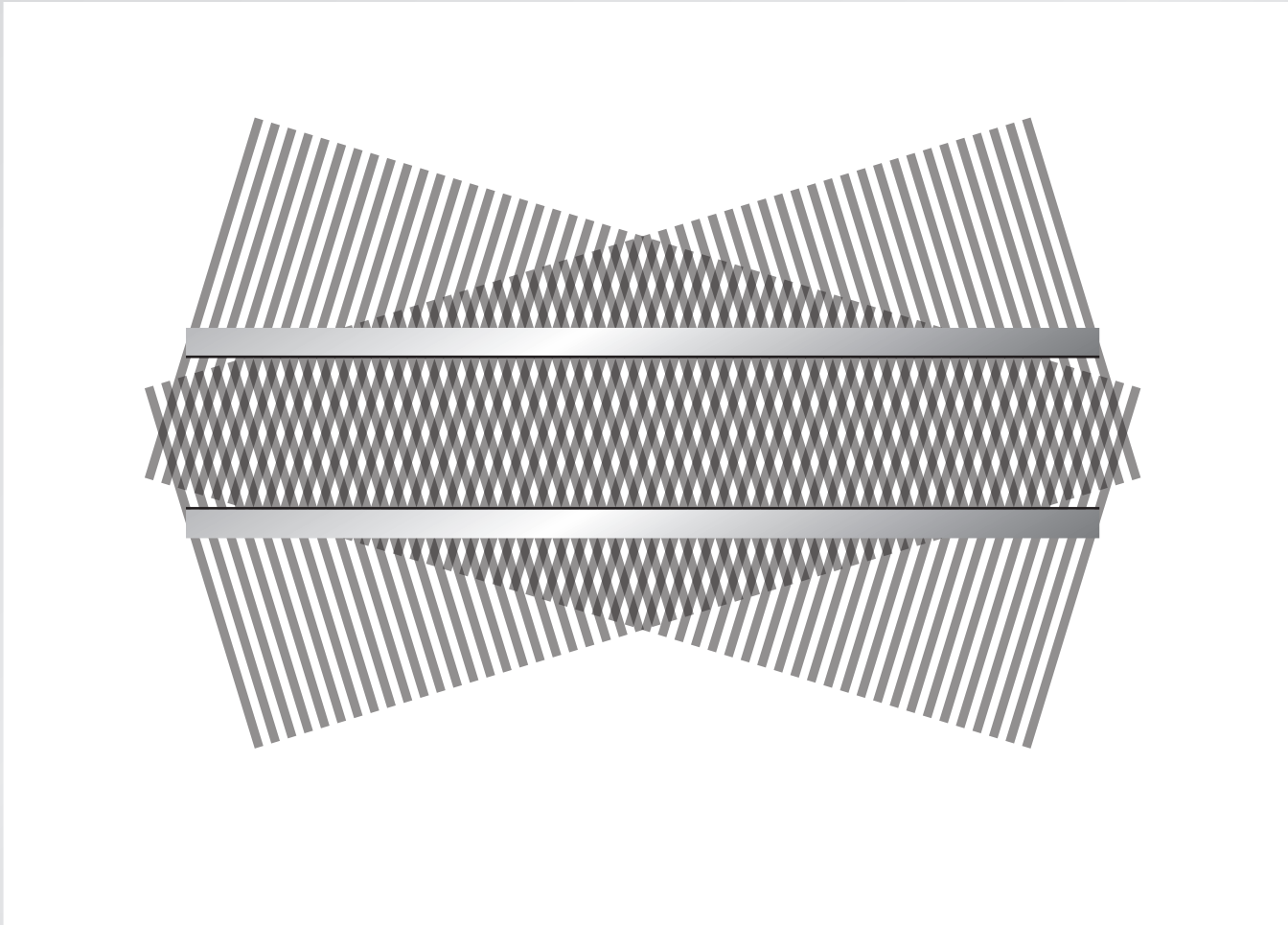

Waveguiding

change angle of incident waves...

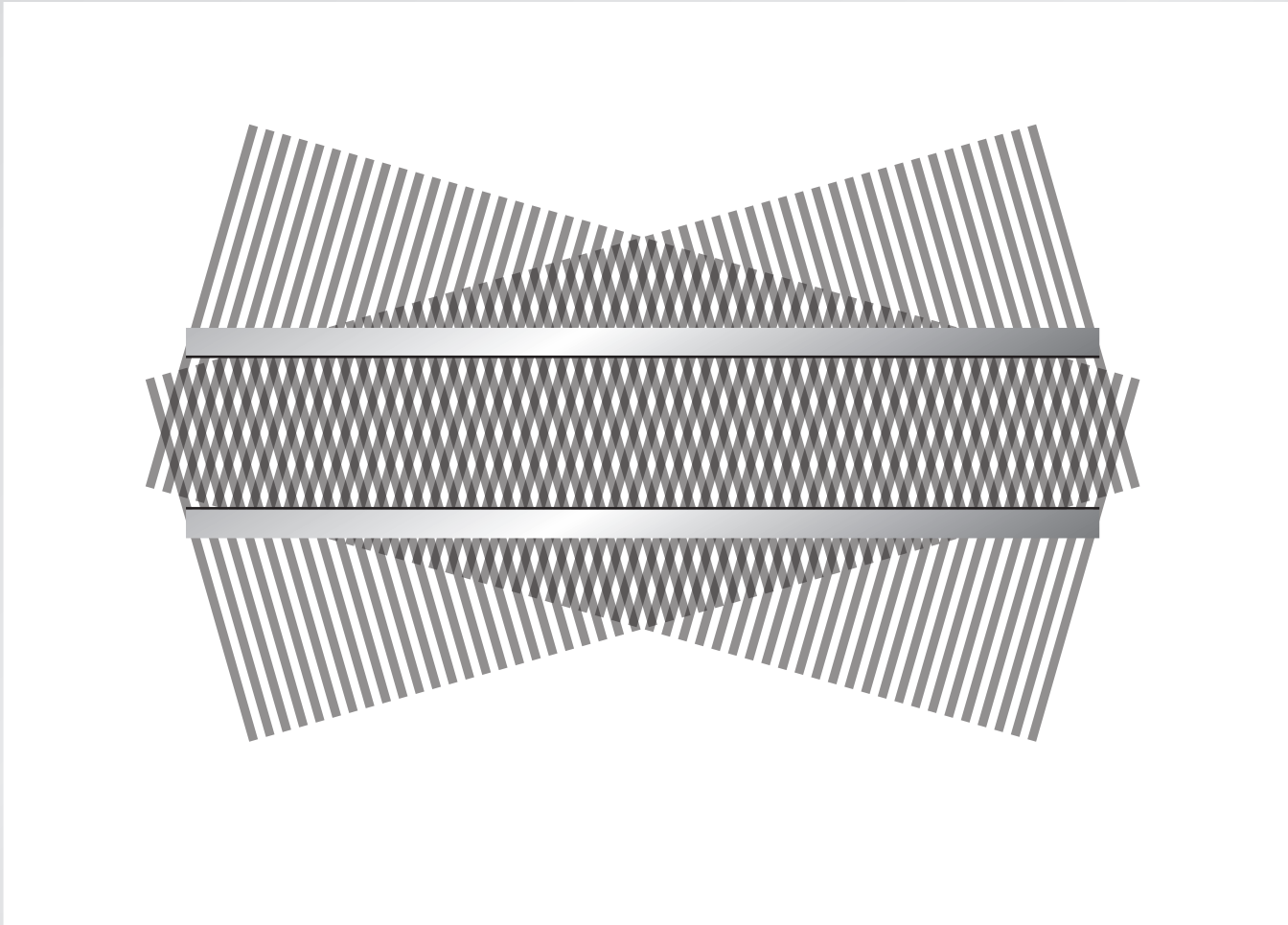

Waveguiding

change angle of incident waves...

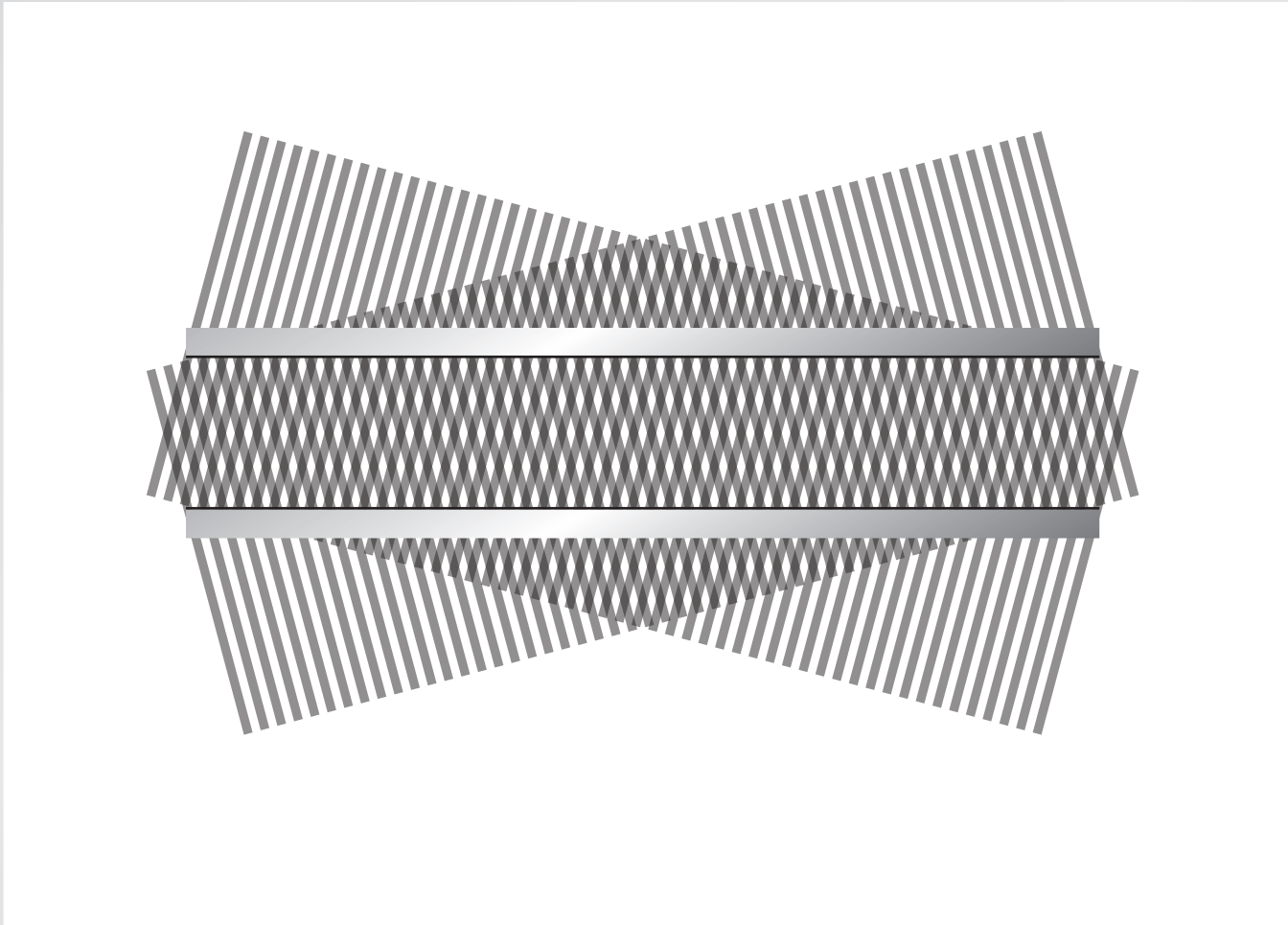

Waveguiding

change angle of incident waves...

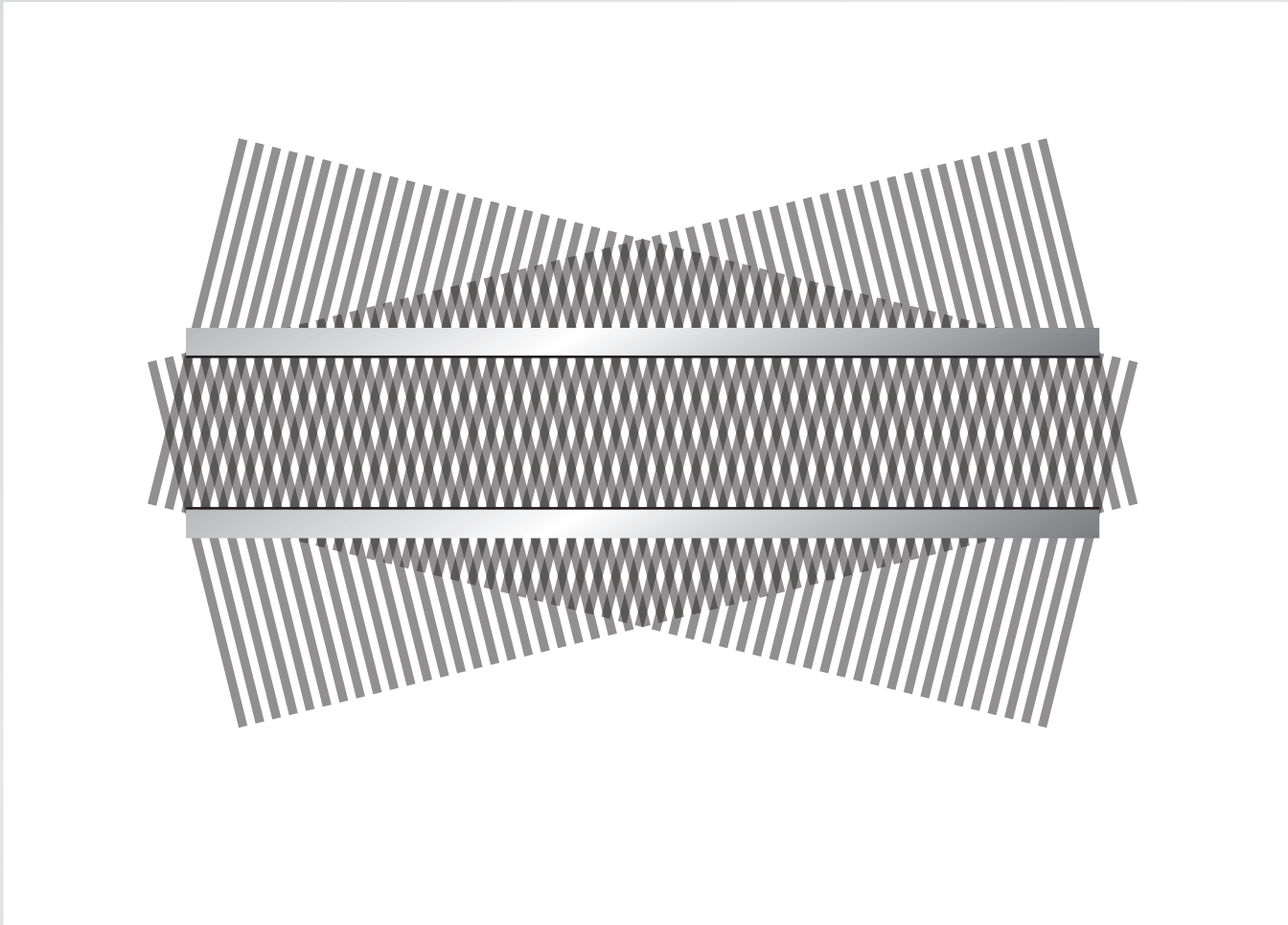

Waveguiding

change angle of incident waves...

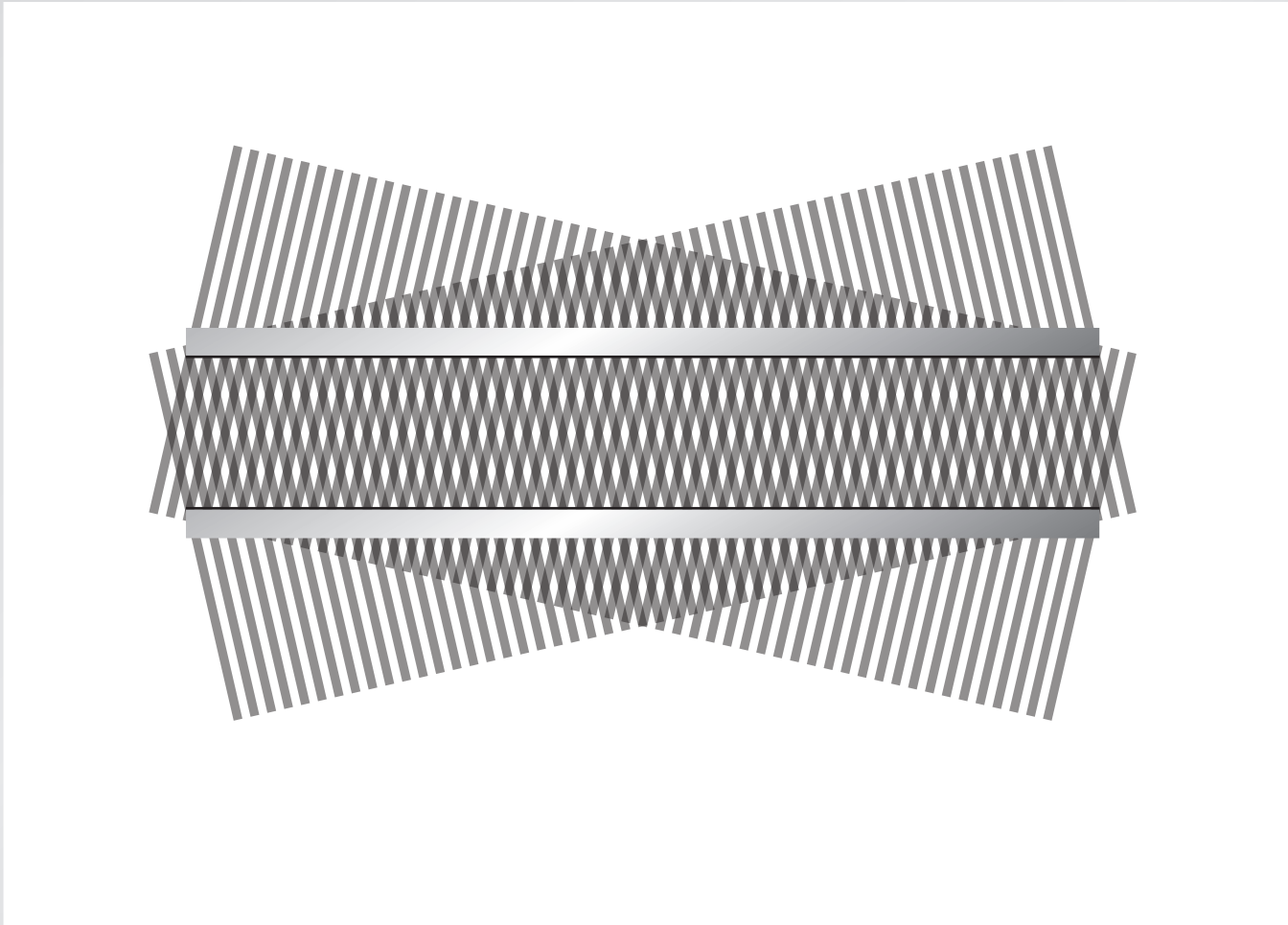

Waveguiding

change angle of incident waves...

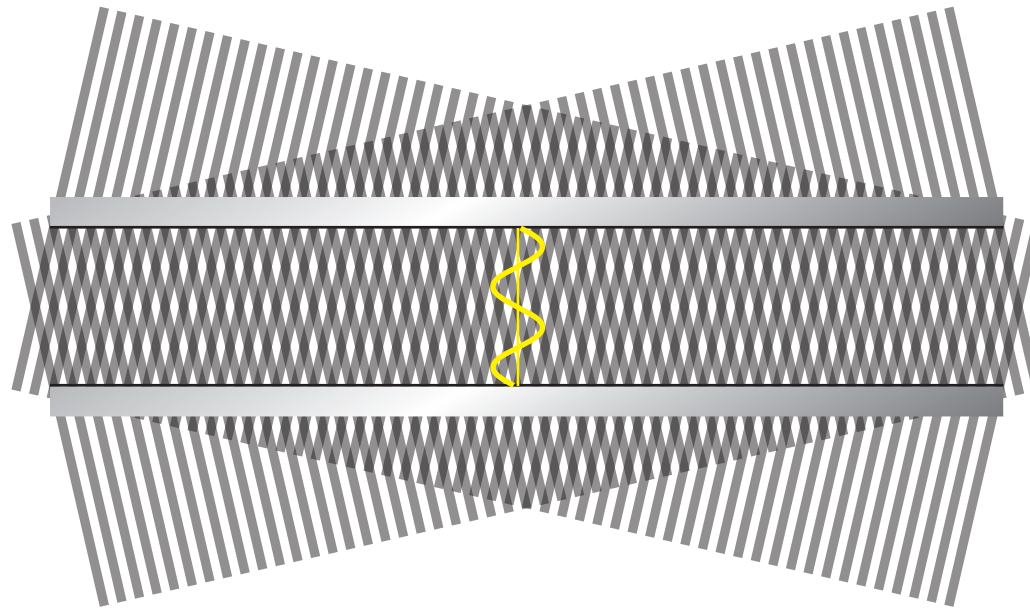

Waveguiding

change angle of incident waves...

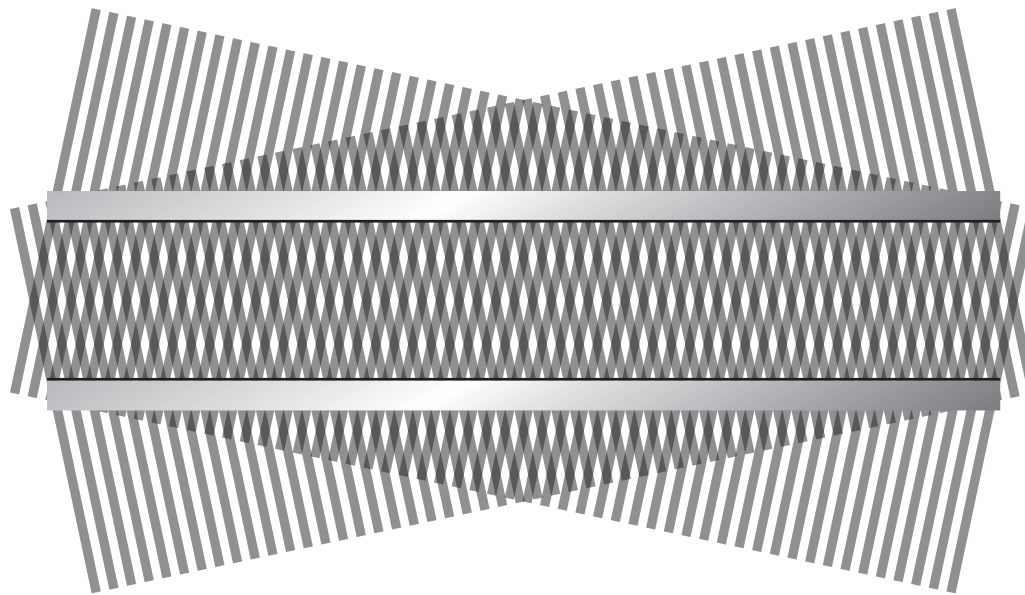

Waveguiding

change angle of incident waves...

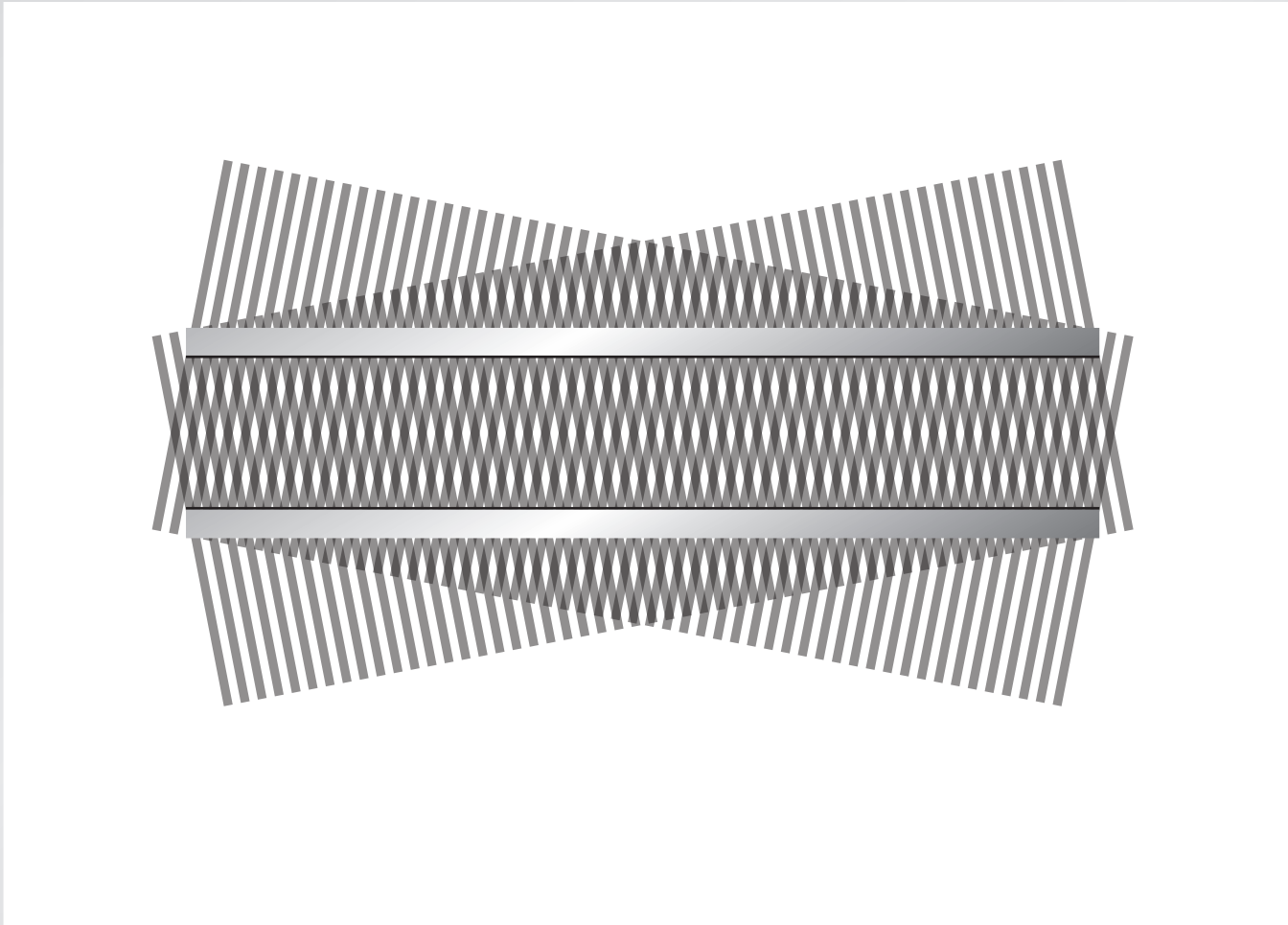

Waveguiding

change angle of incident waves...

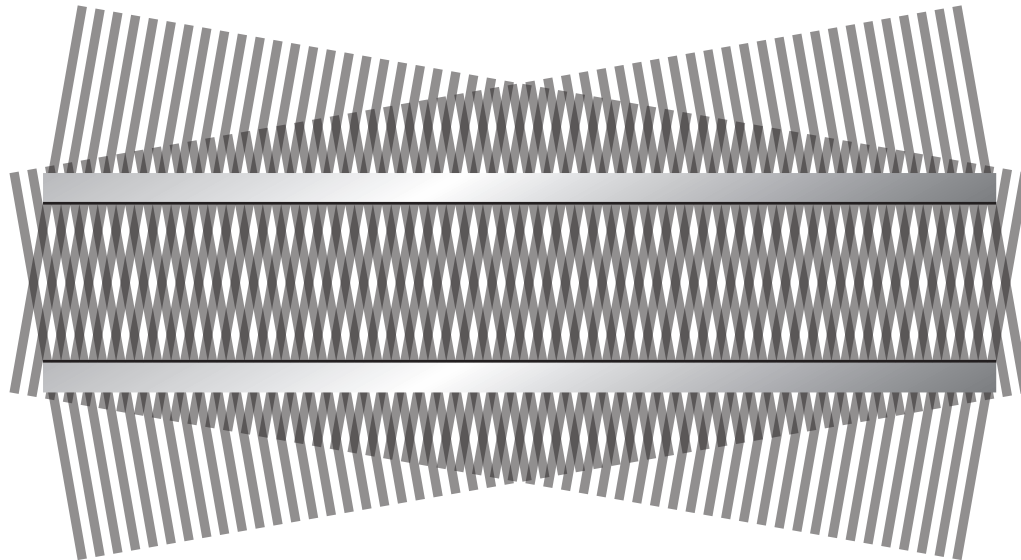

Waveguiding

change angle of incident waves...

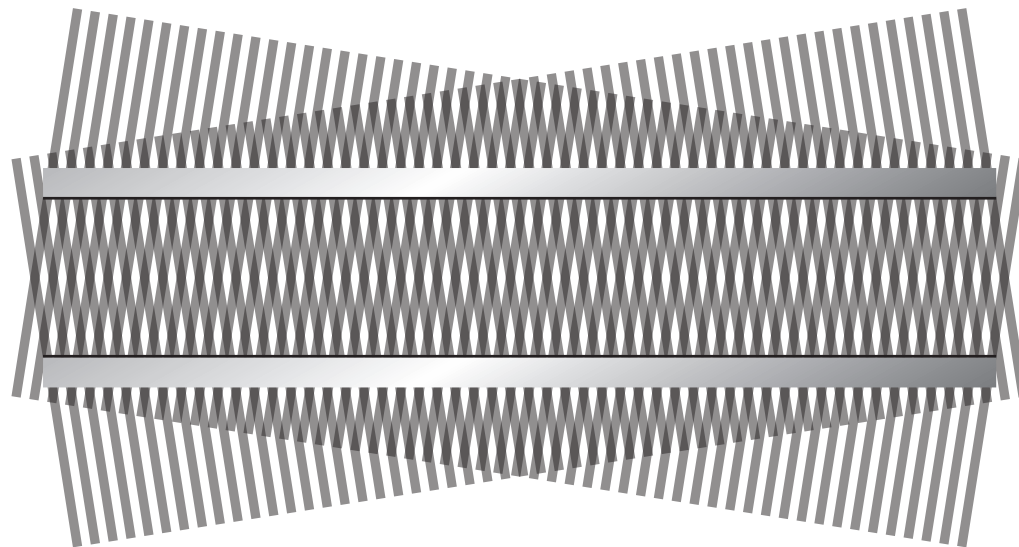

Waveguiding

change angle of incident waves...

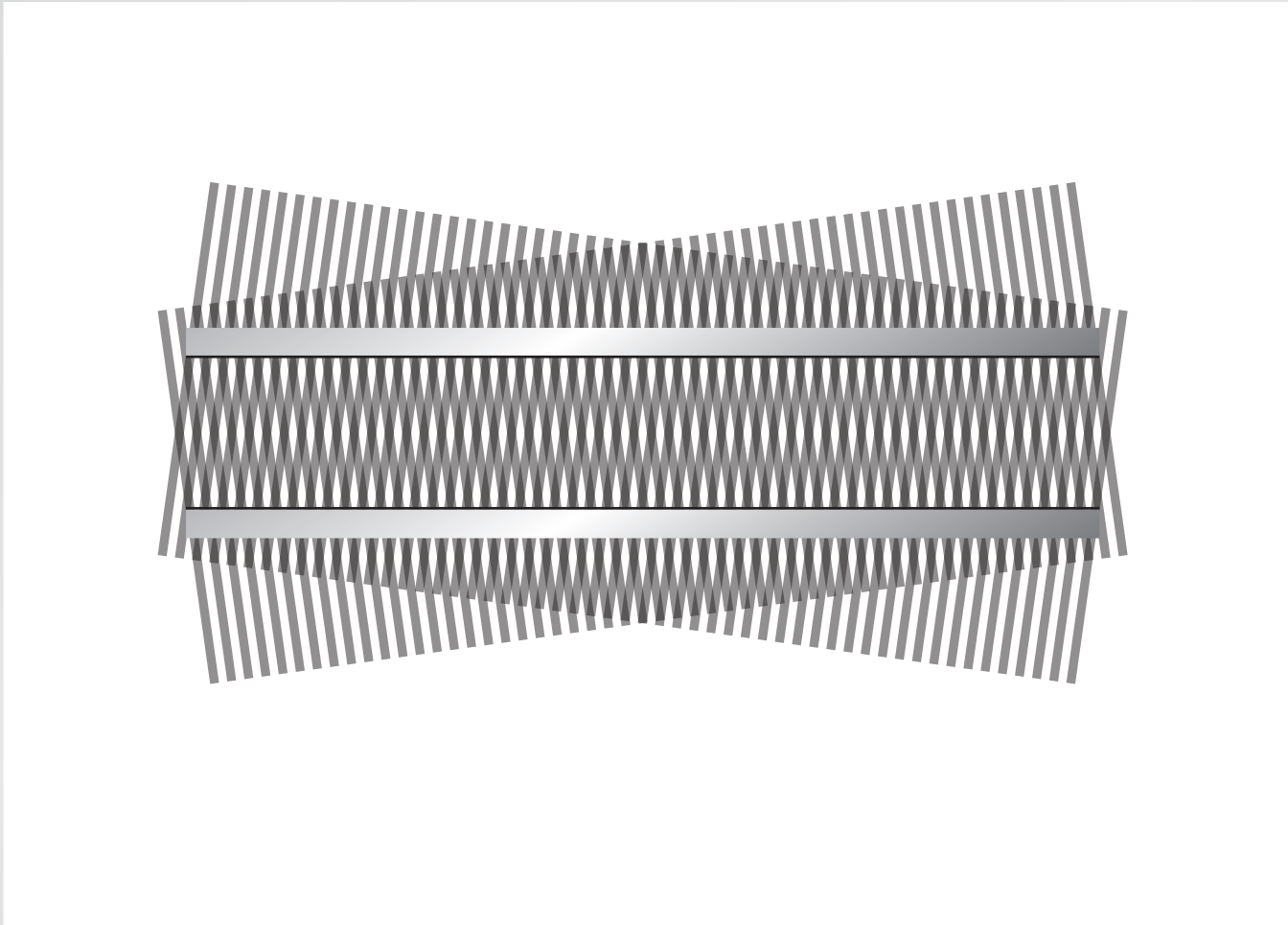

Waveguiding

change angle of incident waves...

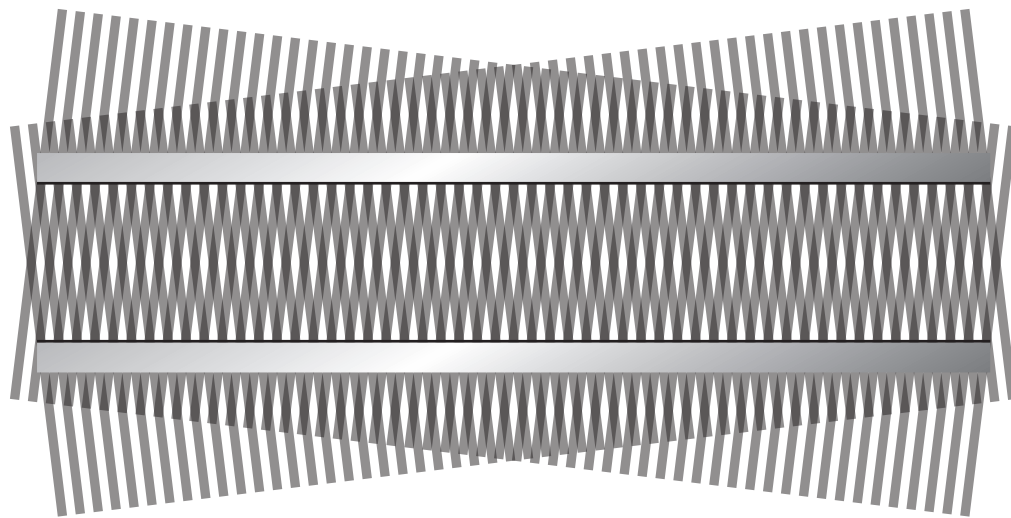

Waveguiding

change angle of incident waves...

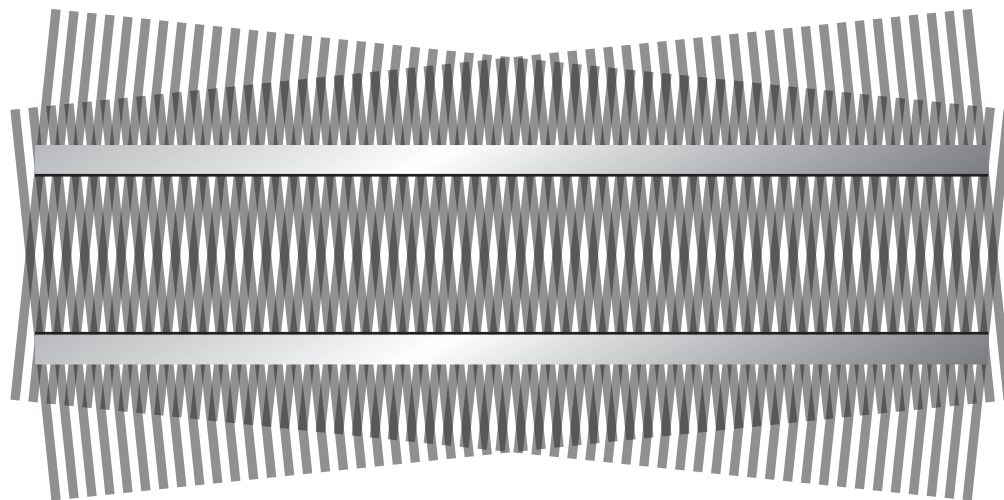

Waveguiding

change angle of incident waves...

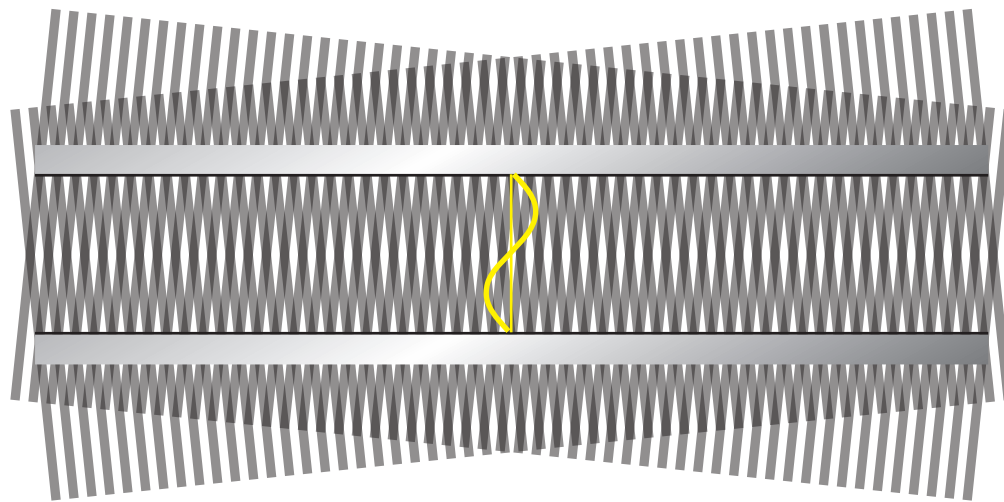

Waveguiding

change angle of incident waves...

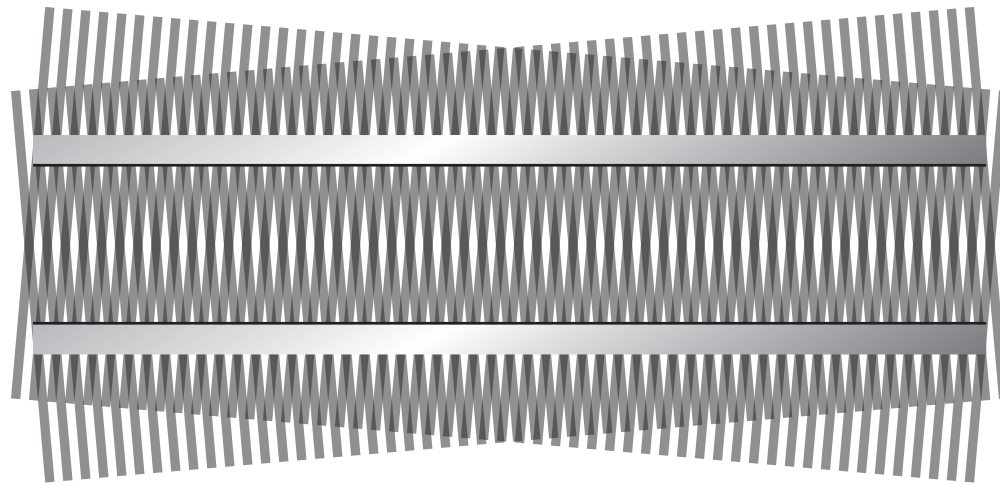

Waveguiding

change angle of incident waves...

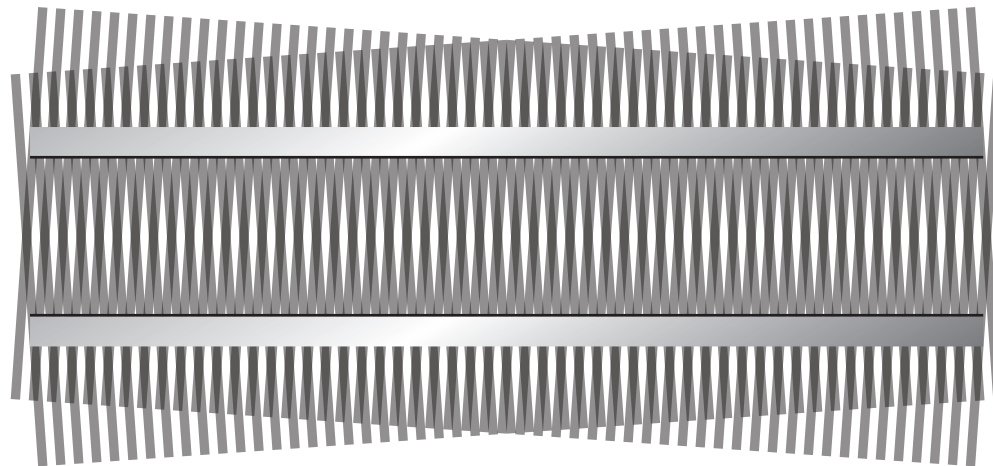

Waveguiding

boundary conditions only satisfied for certain θ

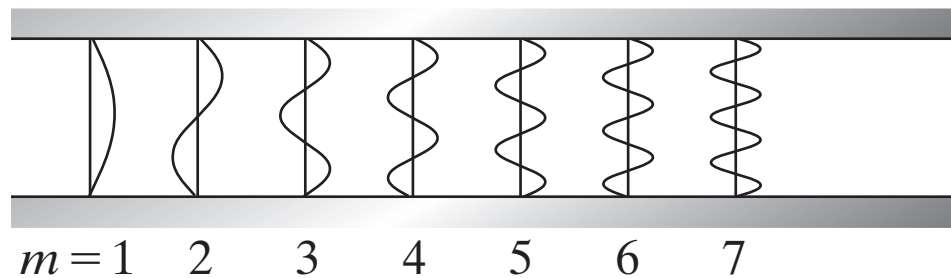

standing wave in y -direction, traveling in z -direction

Waveguiding

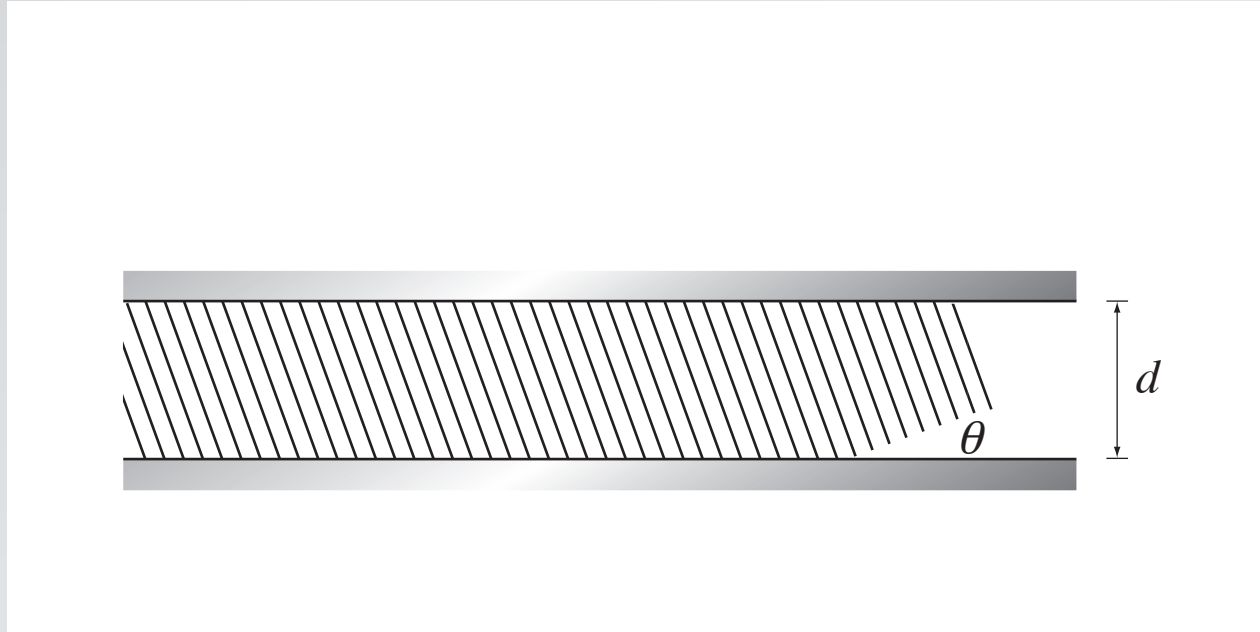

consider wave incident at angle θ

Waveguiding

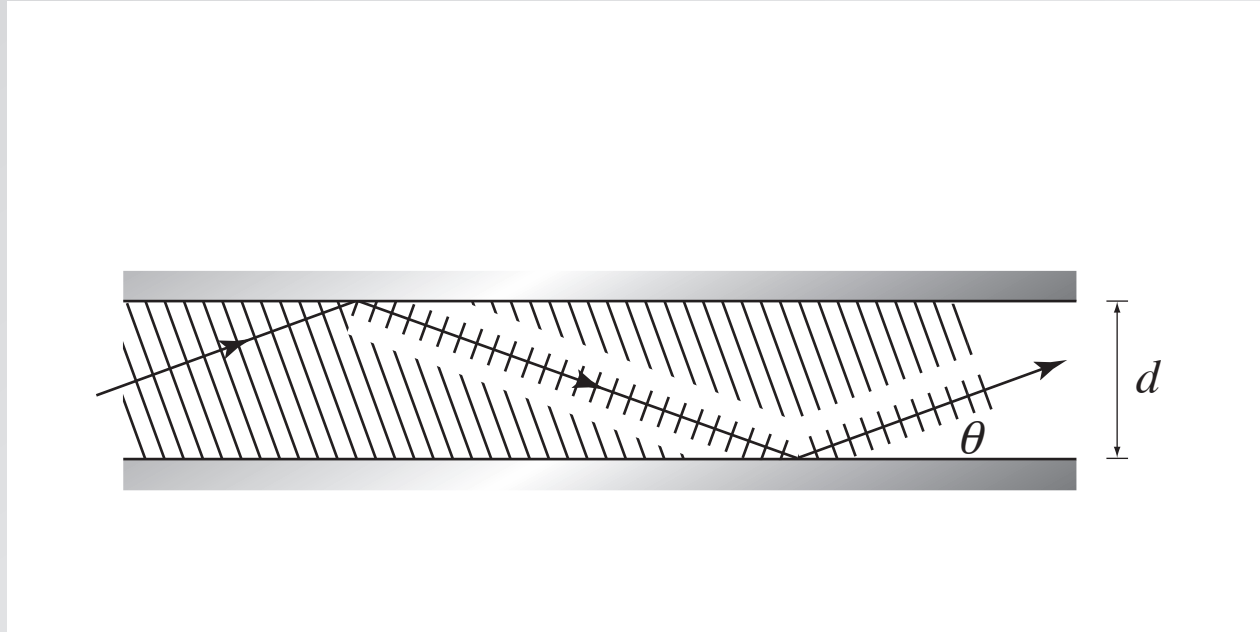

twice-reflected wave

Waveguiding

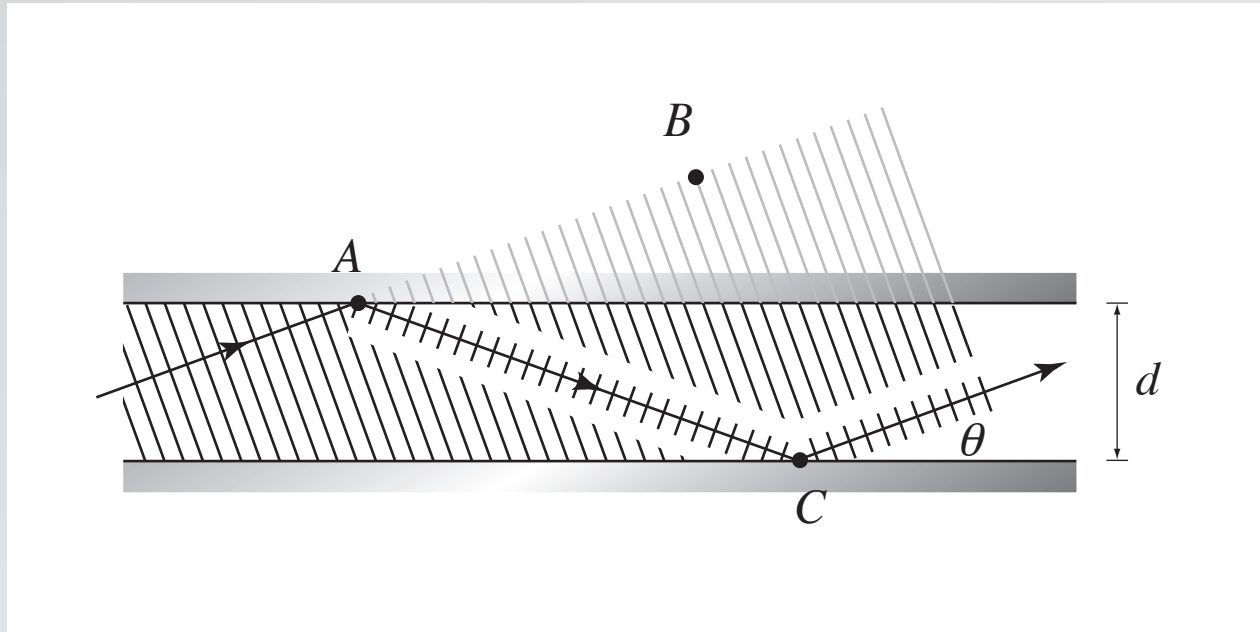

self consistency:

$$AC - AB = 2d \sin\theta = m\lambda \quad (m = 1, 2, \dots)$$

Waveguiding

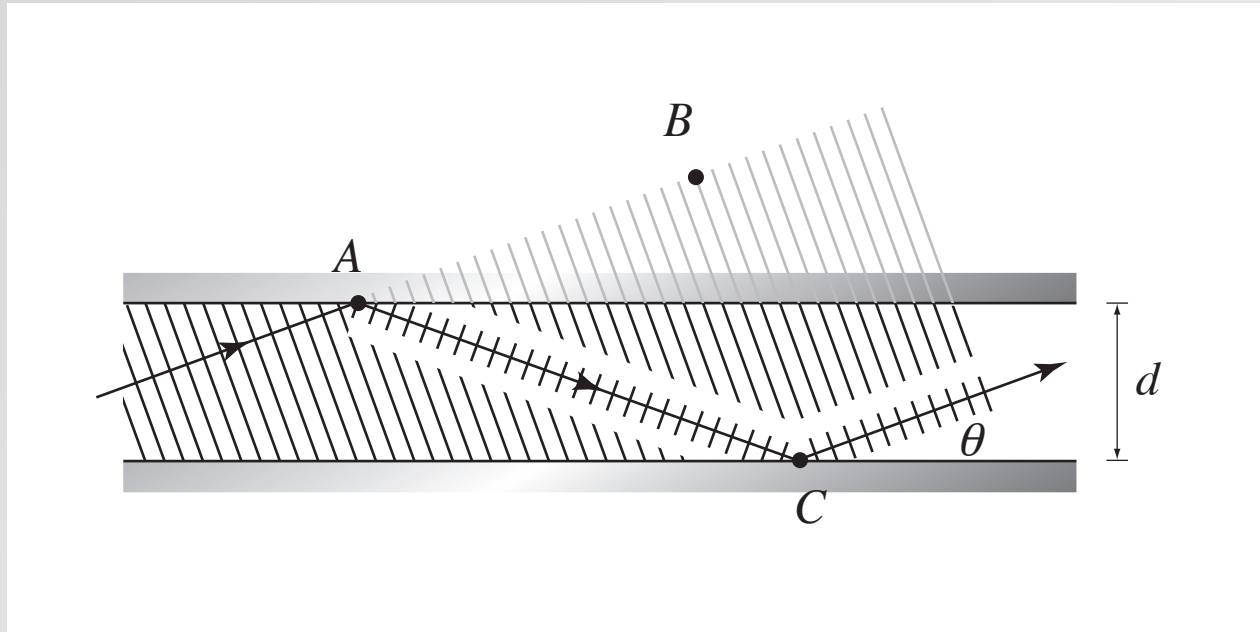

self consistency:

$$AC - AB = 2d \sin \theta = m\lambda \quad (m = 1, 2, \dots)$$

so:

$$\sin \theta_m = m \frac{\lambda}{2d}$$

Waveguiding

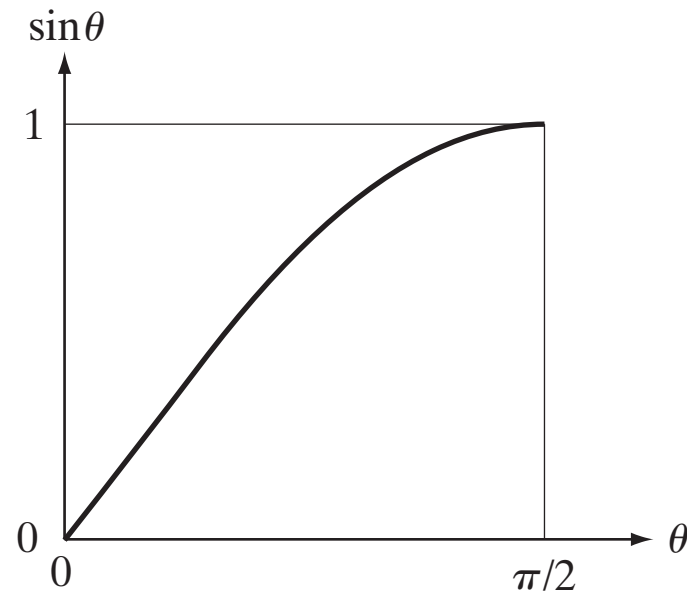

self consistency:

$$AC - AB = 2d \sin \theta = m\lambda \quad (m = 1, 2, \dots)$$

so:

$$\sin \theta_m = m \frac{\lambda}{2d}$$

Waveguiding

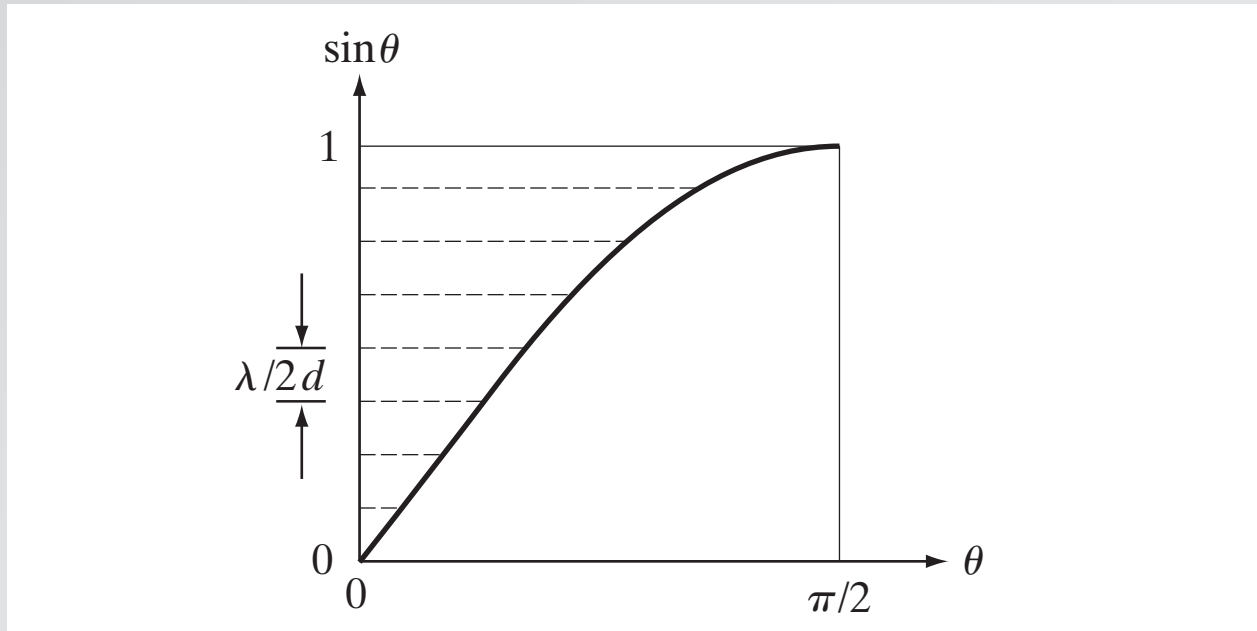

self consistency:

$$AC - AB = 2d \sin \theta = m\lambda \quad (m = 1, 2, \dots)$$

so:

$$\sin \theta_m = m \frac{\lambda}{2d}$$

Waveguiding

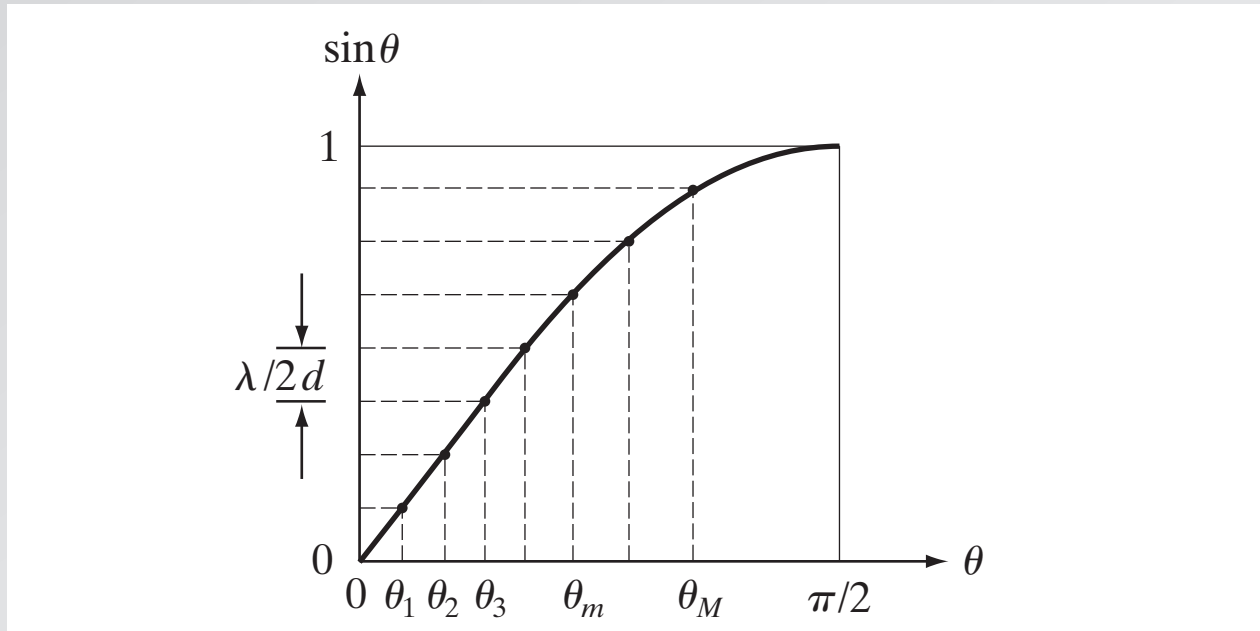

self consistency:

$$AC - AB = 2d \sin \theta = m\lambda \quad (m = 1, 2, \dots)$$

so:

$$\sin \theta_m = m \frac{\lambda}{2d}$$

Waveguiding

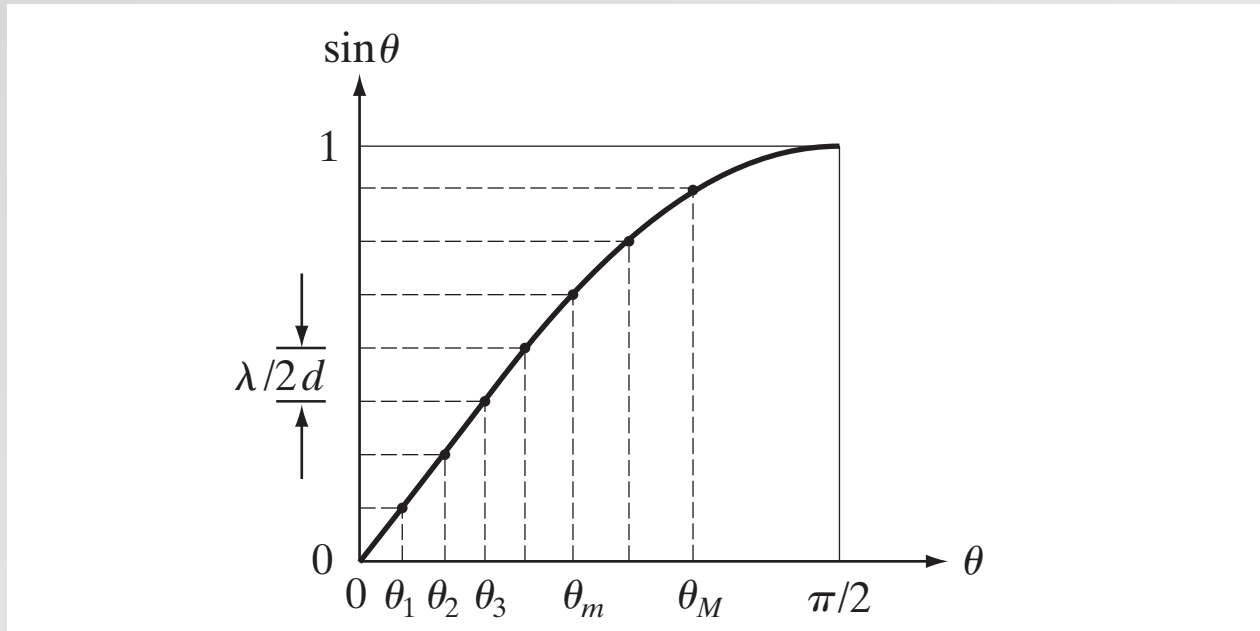

number of modes:

$$M = \frac{2d}{\lambda}$$

Waveguiding



now consider a planar dielectric waveguide

Waveguiding

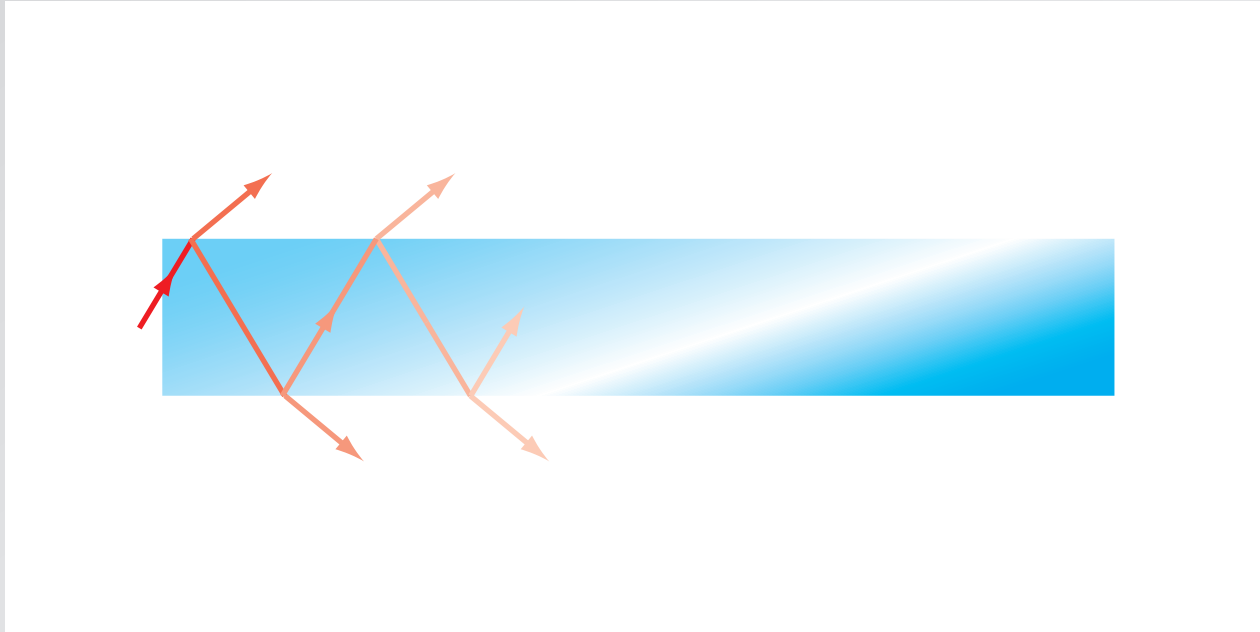

rays incident at angle $\theta > \pi/2 - \theta_c$ are unguided

Waveguiding

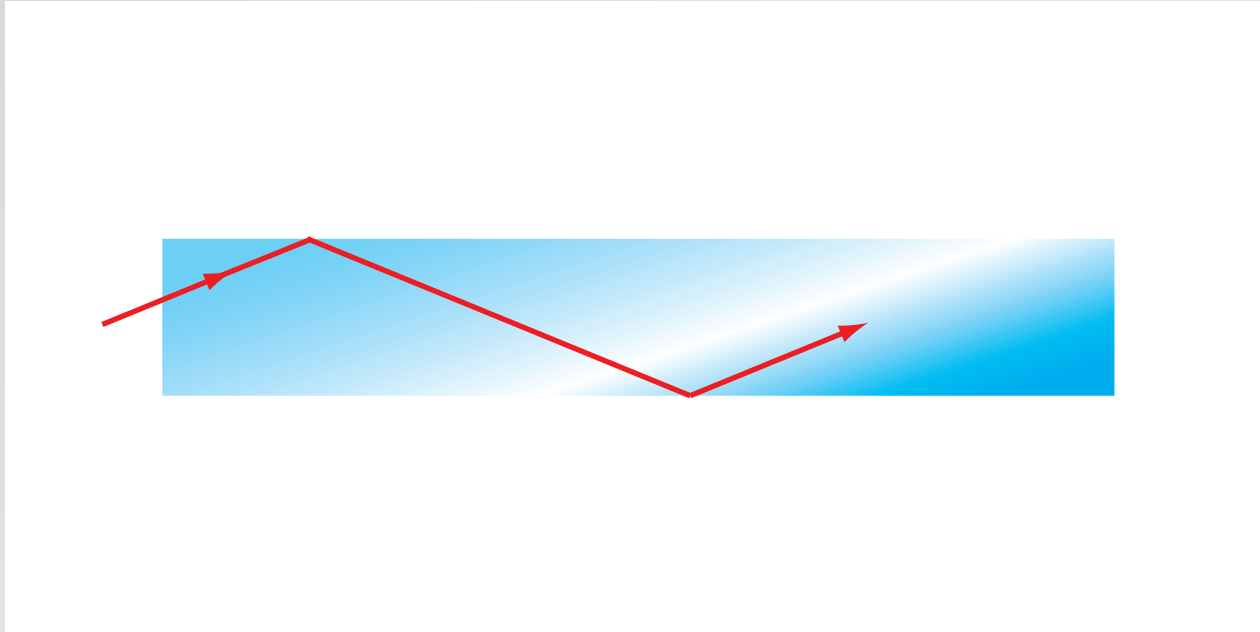

rays incident at angle $\theta < \pi/2 - \theta_c$ are guided

Waveguiding

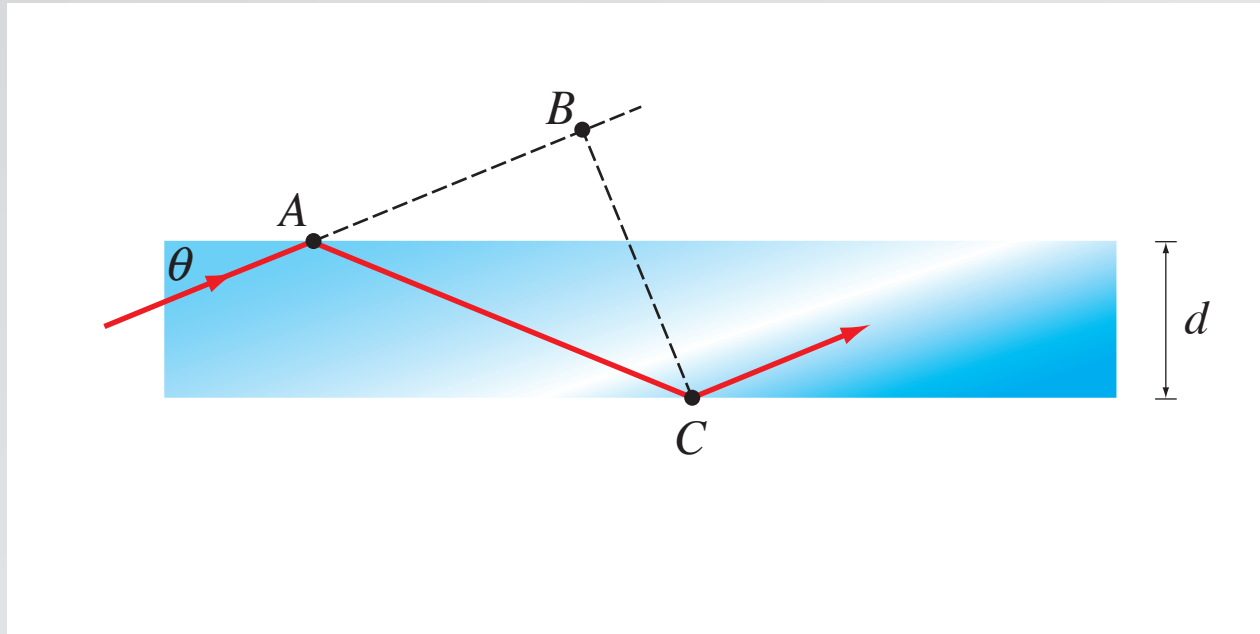

rays incident at angle $\theta < \pi/2 - \theta_c$ are guided

Waveguiding

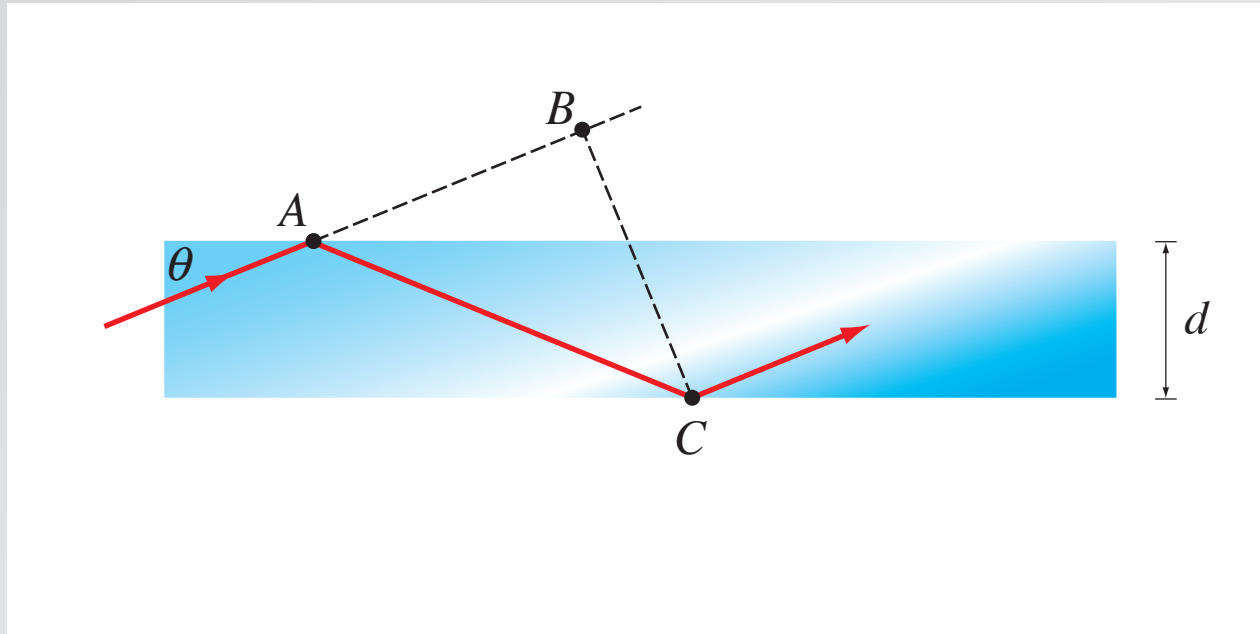

self consistency:

$$AC - AB = 2d \sin\theta - \frac{\varphi_r}{\pi} \lambda = m\lambda \quad (m = 0, 1, 2\dots)$$

Waveguiding

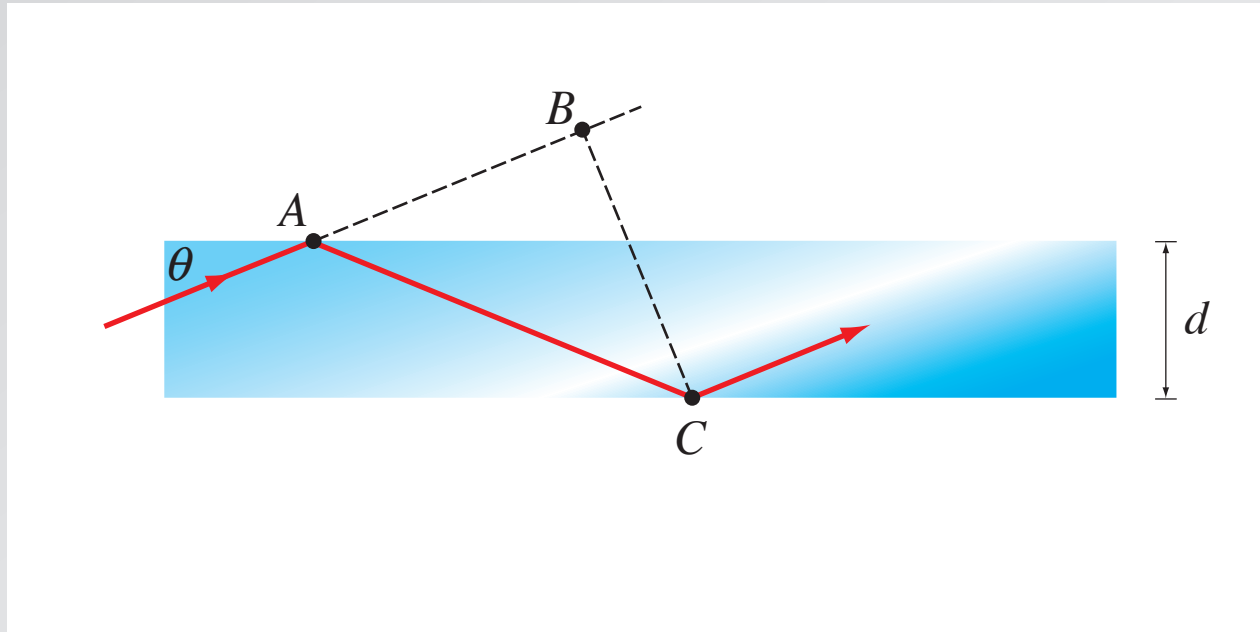

self consistency:

$$AC - AB = 2d \sin\theta - \frac{\varphi_r}{\pi} \lambda = m\lambda \quad (m = 0, 1, 2\dots)$$

SO:

$$\tan\left(\frac{\pi d}{\lambda} \sin\theta - m\frac{\pi}{2}\right) = \left(\frac{\sin^2(\pi/2 - \theta_c)}{\sin^2\theta} - 1\right)^{1/2}$$

Waveguiding

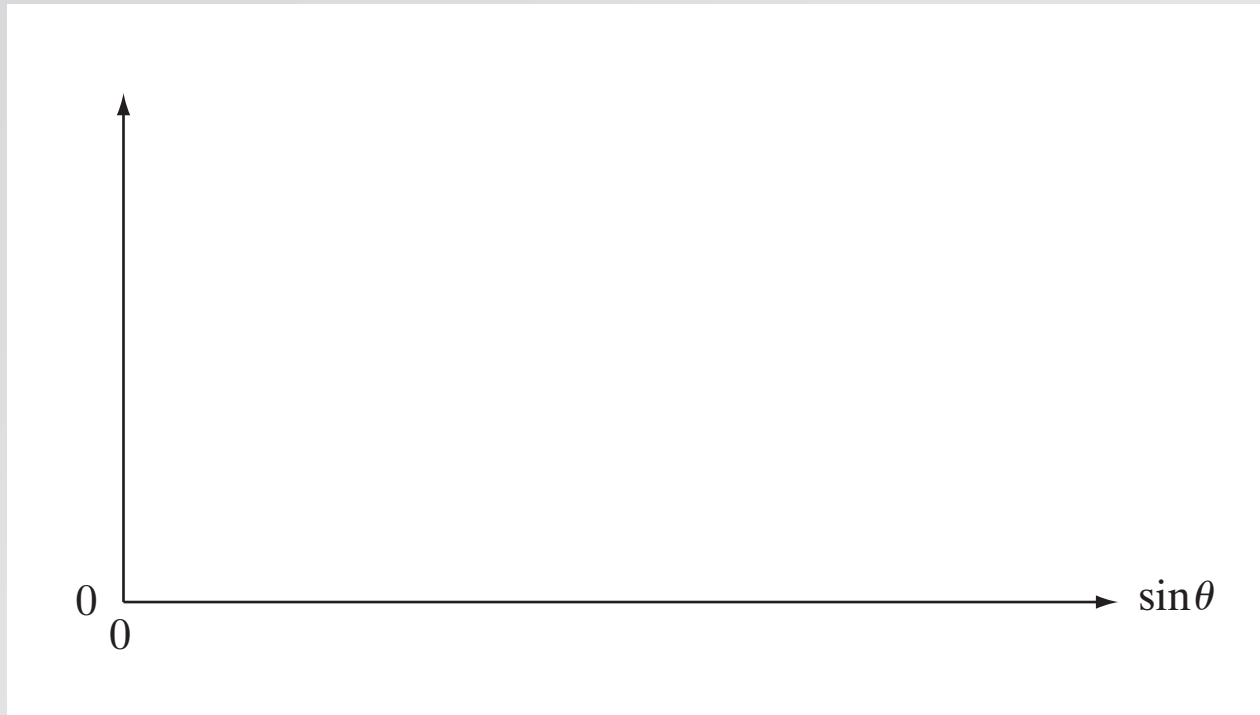

self consistency:

$$AC - AB = 2d \sin \theta - \frac{\varphi_r}{\pi} \lambda = m \lambda \quad (m = 0, 1, 2 \dots)$$

SO:

$$\tan \left(\frac{\pi d}{\lambda} \sin \theta - m \frac{\pi}{2} \right) = \left(\frac{\sin^2(\pi/2 - \theta_c)}{\sin^2 \theta} - 1 \right)^{1/2}$$

Waveguiding

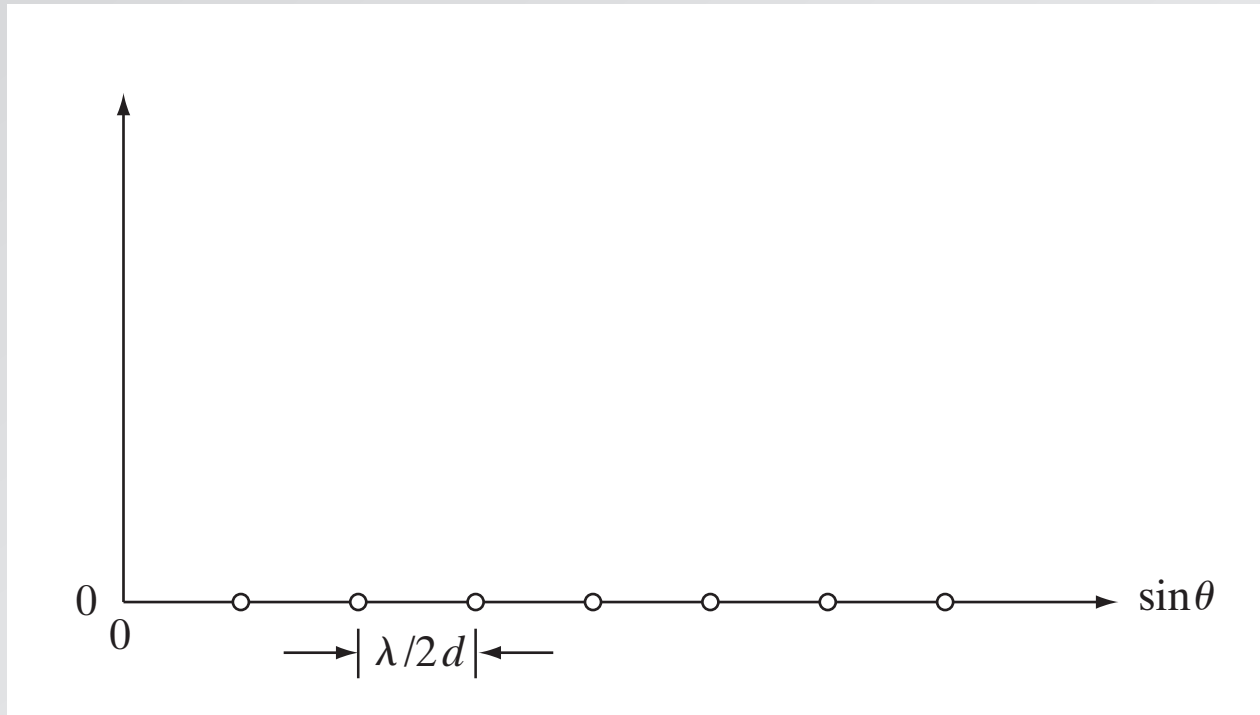

self consistency:

$$AC - AB = 2d \sin \theta - \frac{\varphi_r}{\pi} \lambda = m \lambda \quad (m = 0, 1, 2 \dots)$$

SO:

$$\tan \left(\frac{\pi d}{\lambda} \sin \theta - m \frac{\pi}{2} \right) = \left(\frac{\sin^2(\pi/2 - \theta_c)}{\sin^2 \theta} - 1 \right)^{1/2}$$

Waveguiding

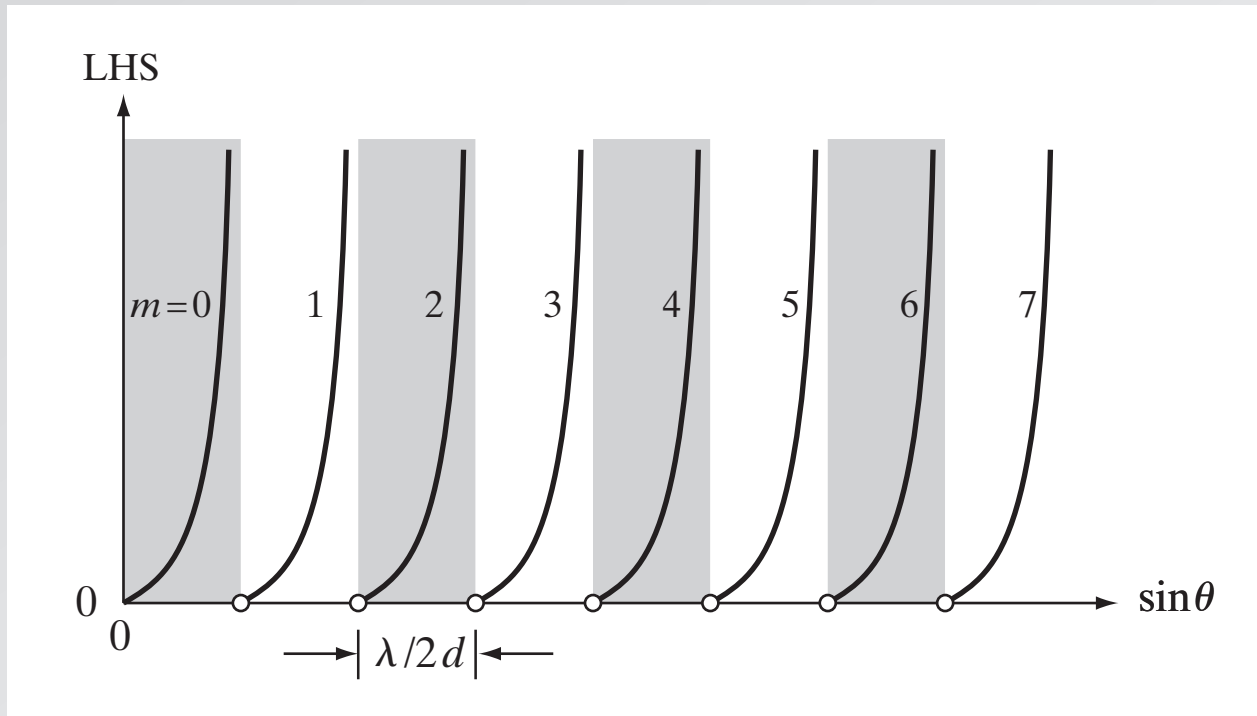

self consistency:

$$AC - AB = 2d \sin \theta - \frac{\varphi_r}{\pi} \lambda = m \lambda \quad (m = 0, 1, 2 \dots)$$

SO:

$$\tan \left(\frac{\pi d}{\lambda} \sin \theta - m \frac{\pi}{2} \right) = \left(\frac{\sin^2(\pi/2 - \theta_c)}{\sin^2 \theta} - 1 \right)^{1/2}$$

Waveguiding

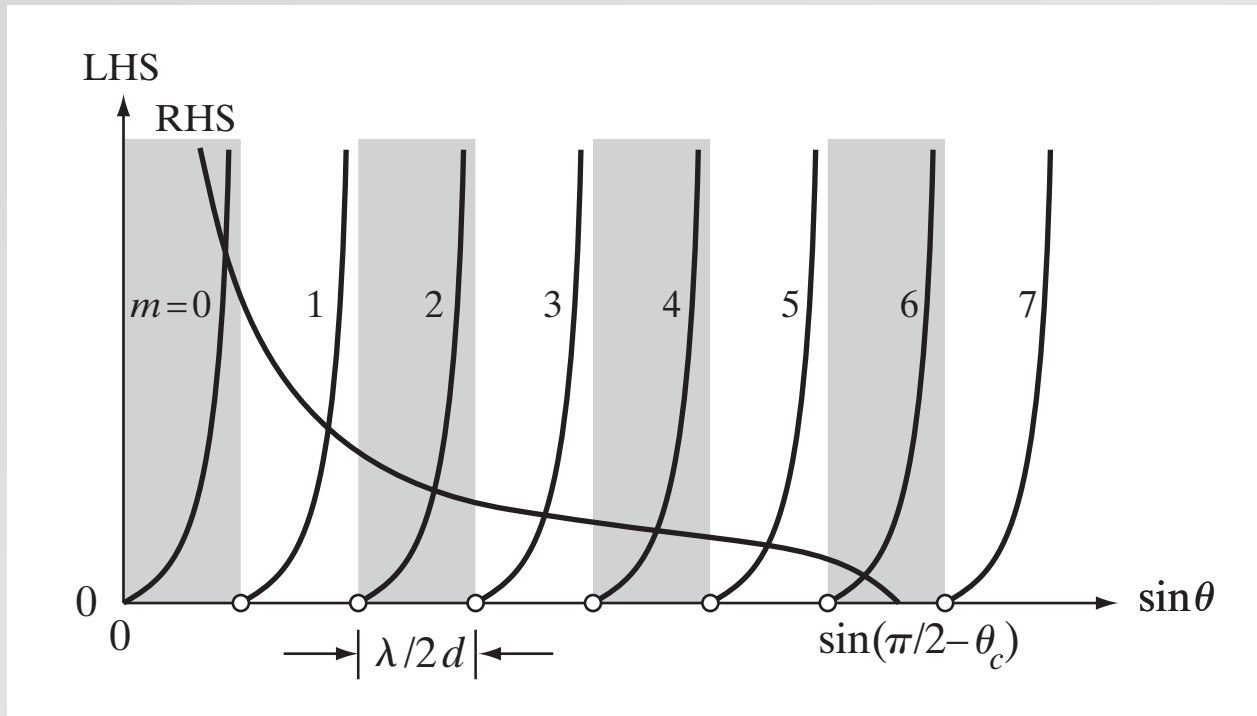

self consistency:

$$AC - AB = 2d \sin \theta - \frac{\varphi_r}{\pi} \lambda = m \lambda \quad (m = 0, 1, 2 \dots)$$

SO:

$$\tan \left(\frac{\pi d}{\lambda} \sin \theta - m \frac{\pi}{2} \right) = \left(\frac{\sin^2(\pi/2 - \theta_c)}{\sin^2 \theta} - 1 \right)^{1/2}$$

Waveguiding

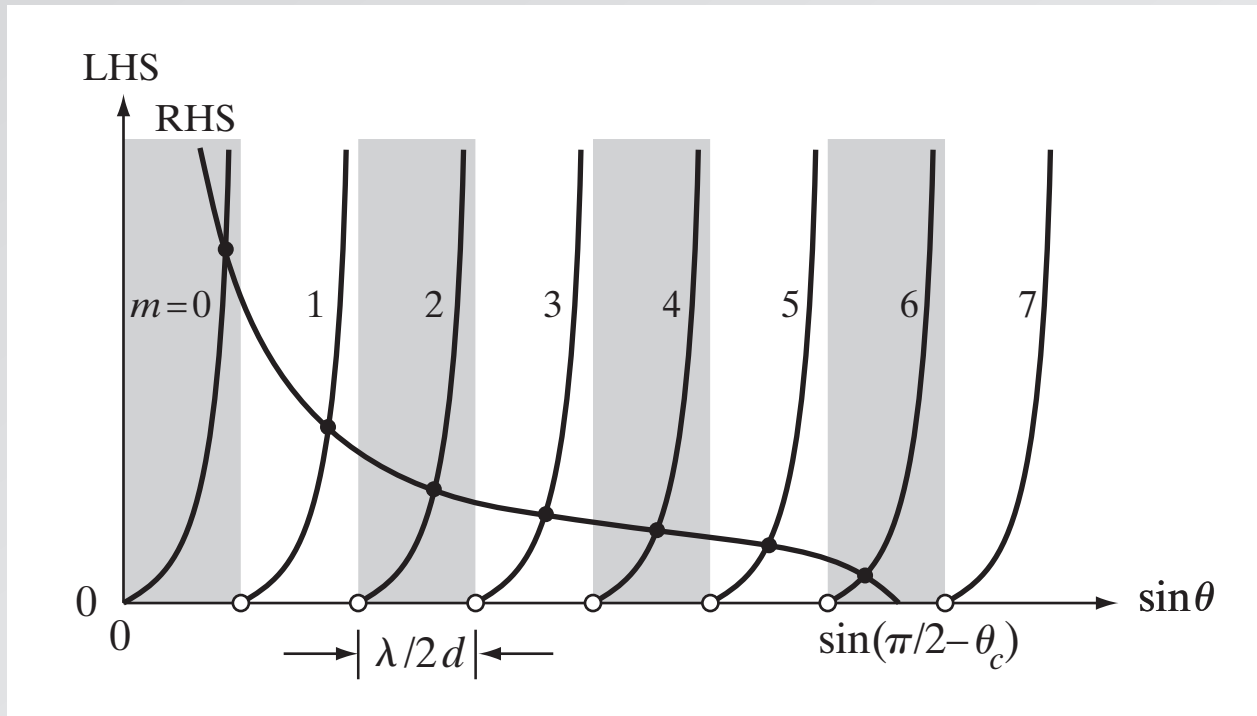

self consistency:

$$AC - AB = 2d \sin \theta - \frac{\varphi_r}{\pi} \lambda = m \lambda \quad (m = 0, 1, 2 \dots)$$

SO:

$$\tan \left(\frac{\pi d}{\lambda} \sin \theta - m \frac{\pi}{2} \right) = \left(\frac{\sin^2(\pi/2 - \theta_c)}{\sin^2 \theta} - 1 \right)^{1/2}$$

Waveguiding

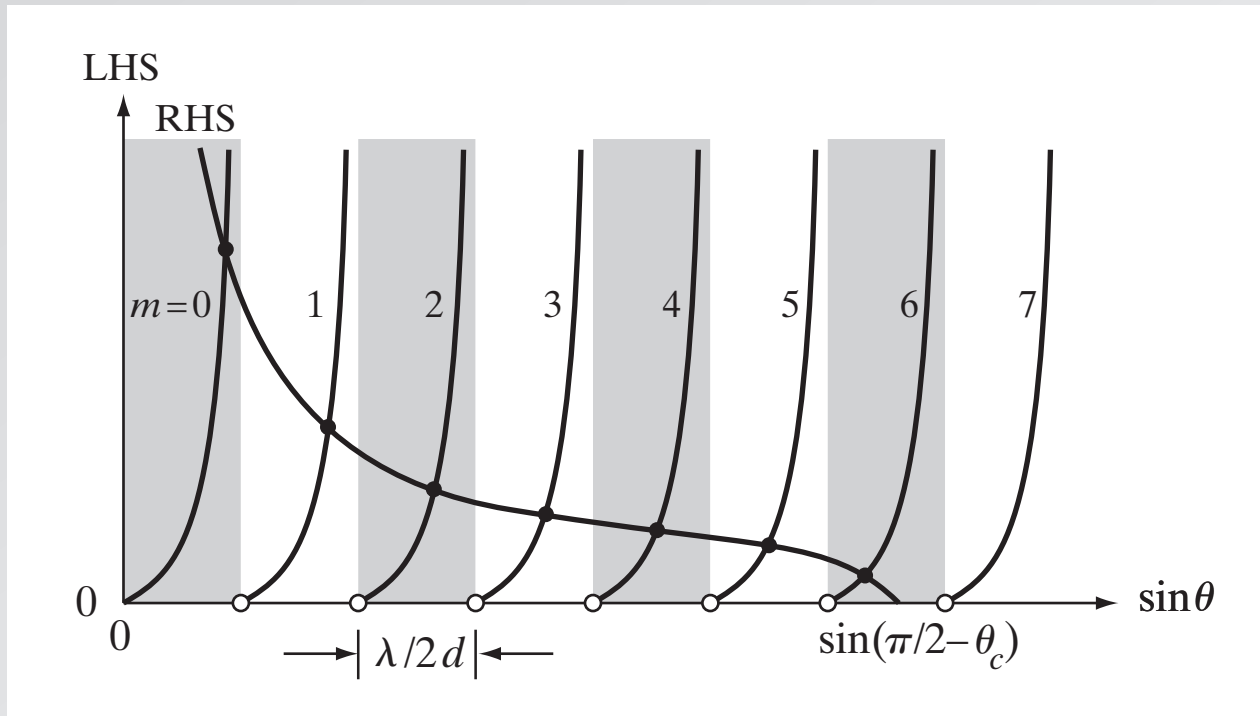

number of modes:

$$M \doteq \frac{\sin(\pi/2 - \theta_c)}{\lambda/2d}$$

Waveguiding

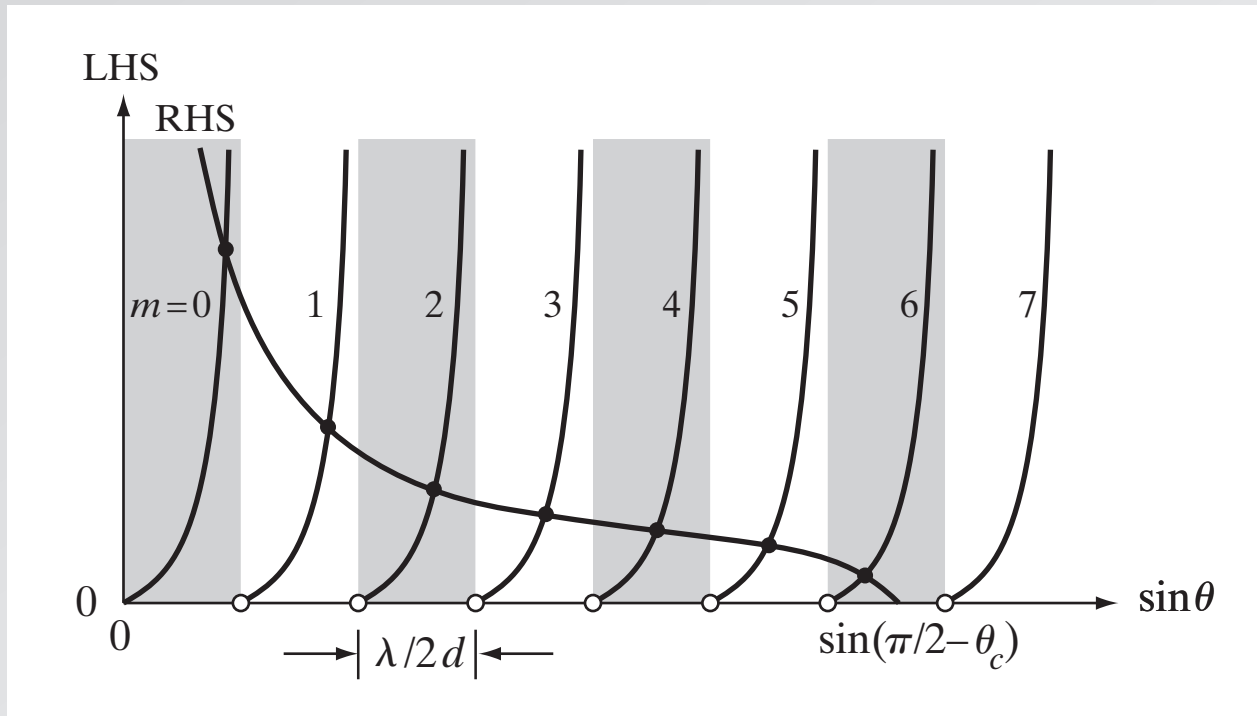

number of modes:

$$M \doteq \frac{\sin(\pi/2 - \theta_c)}{\lambda/2d}$$

or:

$$M \doteq 2 \frac{d}{\lambda} (n_1^2 - n_2^2)^{1/2}$$

Waveguiding

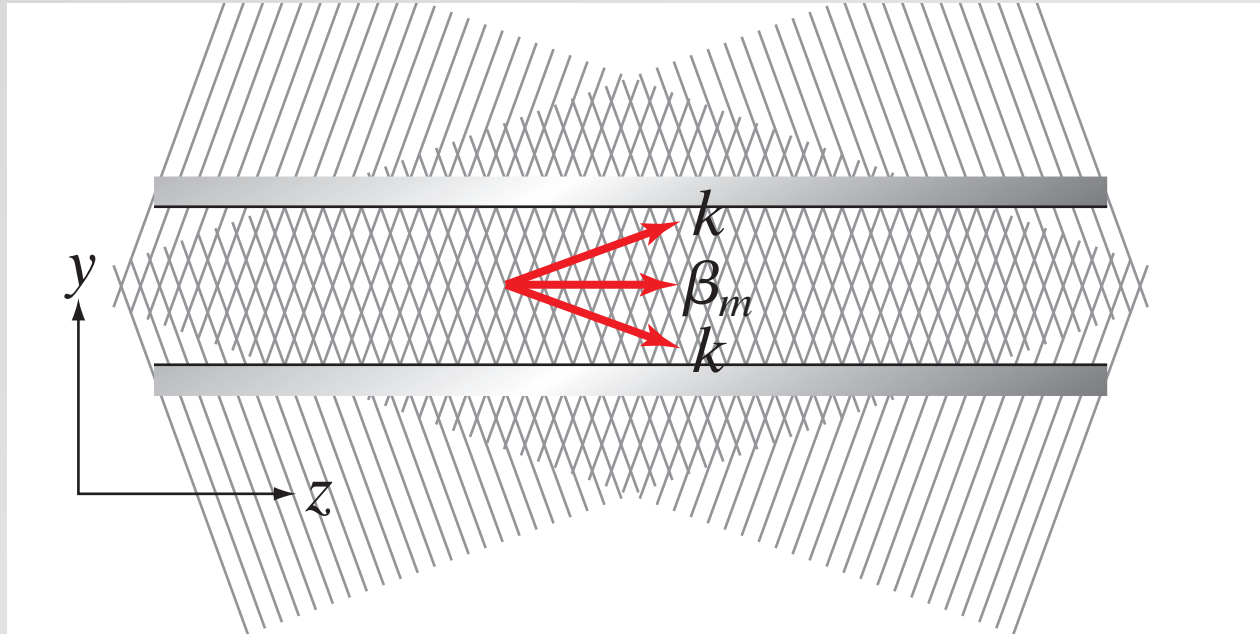

propagation constant of guided wave:

$$\beta_m^2 = k^2 - k_y^2 = k^2 - \frac{m^2 \pi^2}{d^2}$$

group velocity:

$$v_m = c \cos \theta_m$$

Waveguiding

single mode condition for 600-nm light:

planar mirror

$$M \doteq \frac{2d}{\lambda}$$

$$300 < d < 600 \text{ nm}$$

dielectric

$$M \doteq 2 \frac{d}{\lambda} (n_1^2 - n_2^2)^{1/2}$$

$$d < 268 \text{ nm}$$

Waveguiding

single mode condition for 600-nm light:

planar mirror

$$M \doteq \frac{2d}{\lambda}$$

$$300 < d < 600 \text{ nm}$$

dielectric

$$M \doteq 2 \frac{d}{\lambda} (n_1^2 - n_2^2)^{1/2}$$

$$d < 268 \text{ nm}$$

can make d larger by making $n_1 - n_2$ smaller!

Waveguiding

Vector potential obeys:

$$\nabla^2 \vec{A} + \omega^2 \mu_o \epsilon \vec{A} = -i\omega \mu_o \nabla \epsilon \Phi$$

Waveguiding

Vector potential obeys:

$$\nabla^2 \vec{A} + \omega^2 \mu_o \epsilon \vec{A} = 0$$

Waveguiding

Vector potential obeys:

$$\nabla^2 \vec{A} + \omega^2 \mu_o \epsilon \vec{A} = 0$$

Substituting

$$\vec{A} = \hat{y} u(x,y) e^{-i\beta z}$$

Waveguiding

Vector potential obeys:

$$\nabla^2 \vec{A} + \omega^2 \mu_o \epsilon \vec{A} = 0$$

Substituting

$$\vec{A} = \hat{y} u(x,y) e^{-i\beta z}$$

yields:

$$\nabla_T^2 u + [-\beta^2 + \omega^2 \mu \epsilon(r)] u = 0$$

Waveguiding

Vector potential obeys:

$$\nabla^2 \vec{A} + \omega^2 \mu_o \epsilon \vec{A} = 0$$

Substituting

$$\vec{A} = \hat{y} u(x,y) e^{-i\beta z}$$

yields:

$$\nabla_T^2 u + [-\beta^2 + \omega^2 \mu \epsilon(r)] u = 0$$

Compare to time-independent Schrödinger equation:

$$\nabla^2 \psi + \frac{2m}{\hbar^2} [E - V(r)] \psi = 0$$

Waveguiding

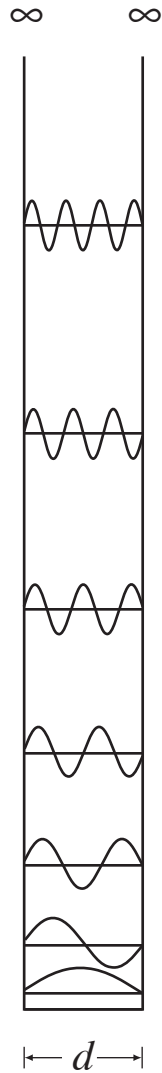

Waveguiding

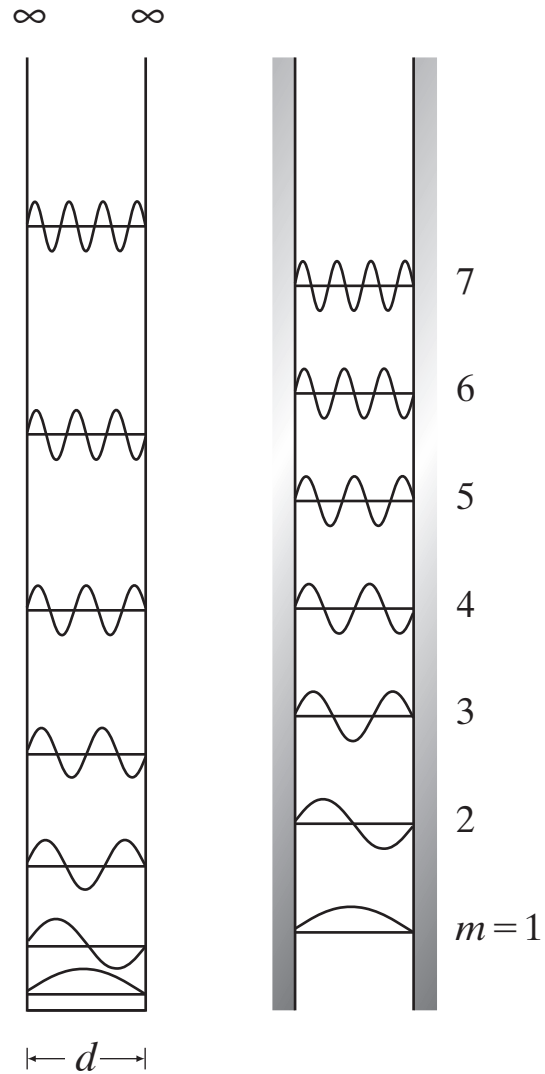

Waveguiding

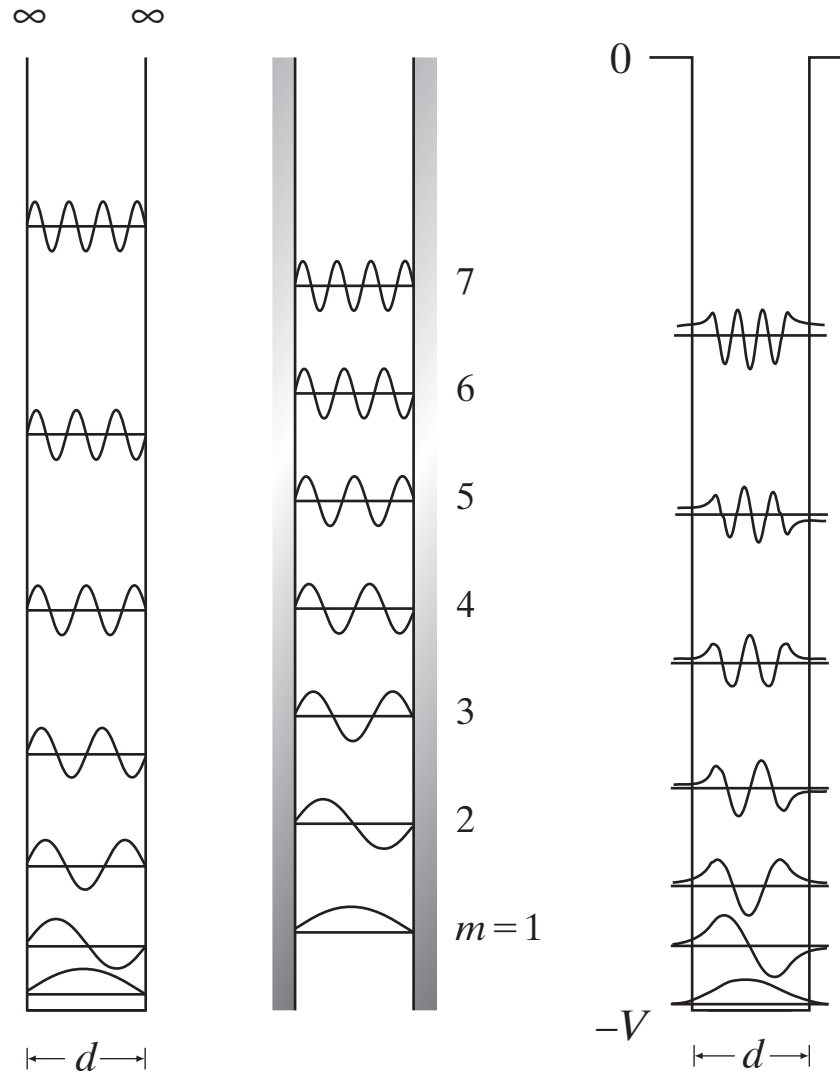

Waveguiding

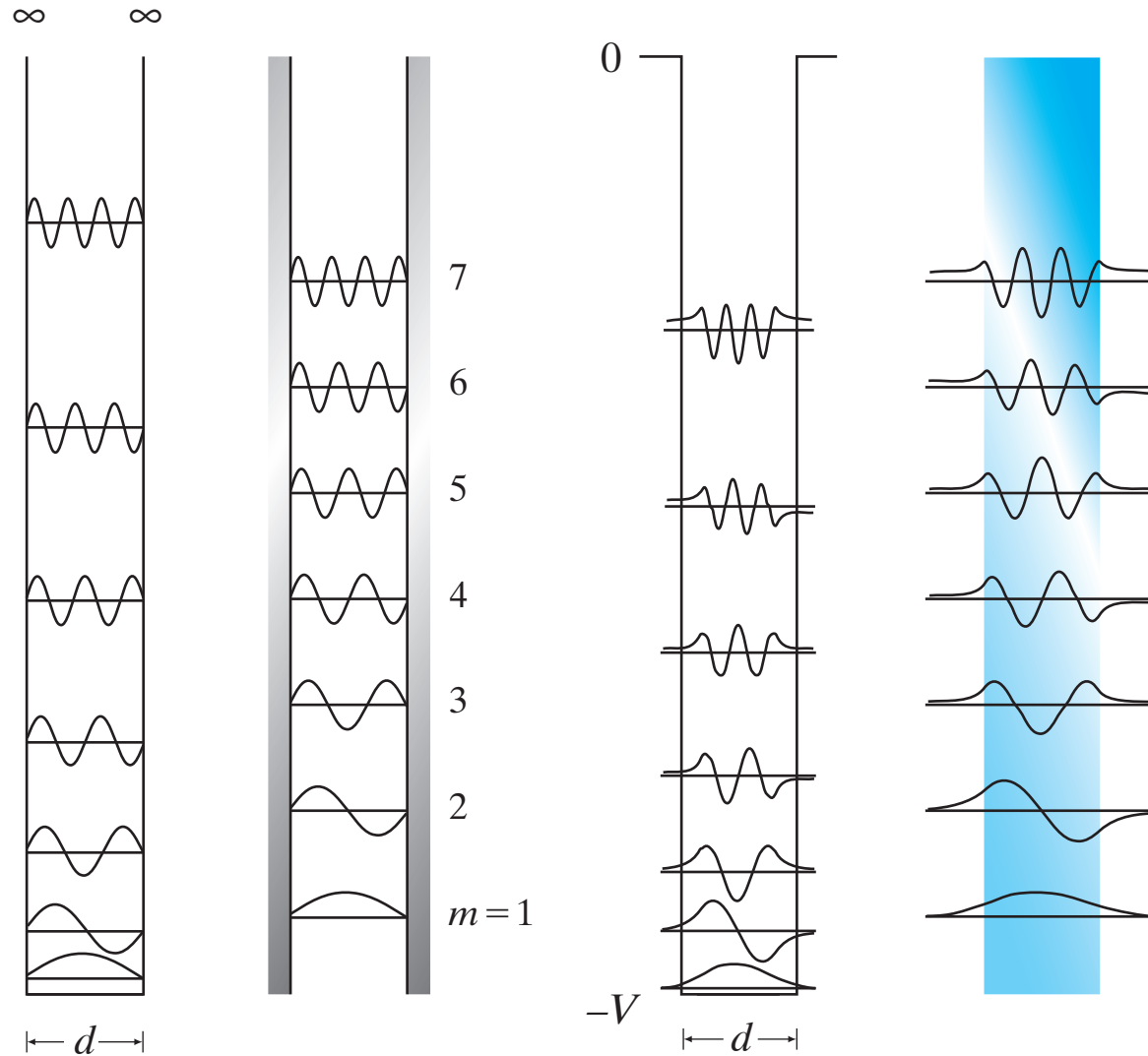

Waveguiding

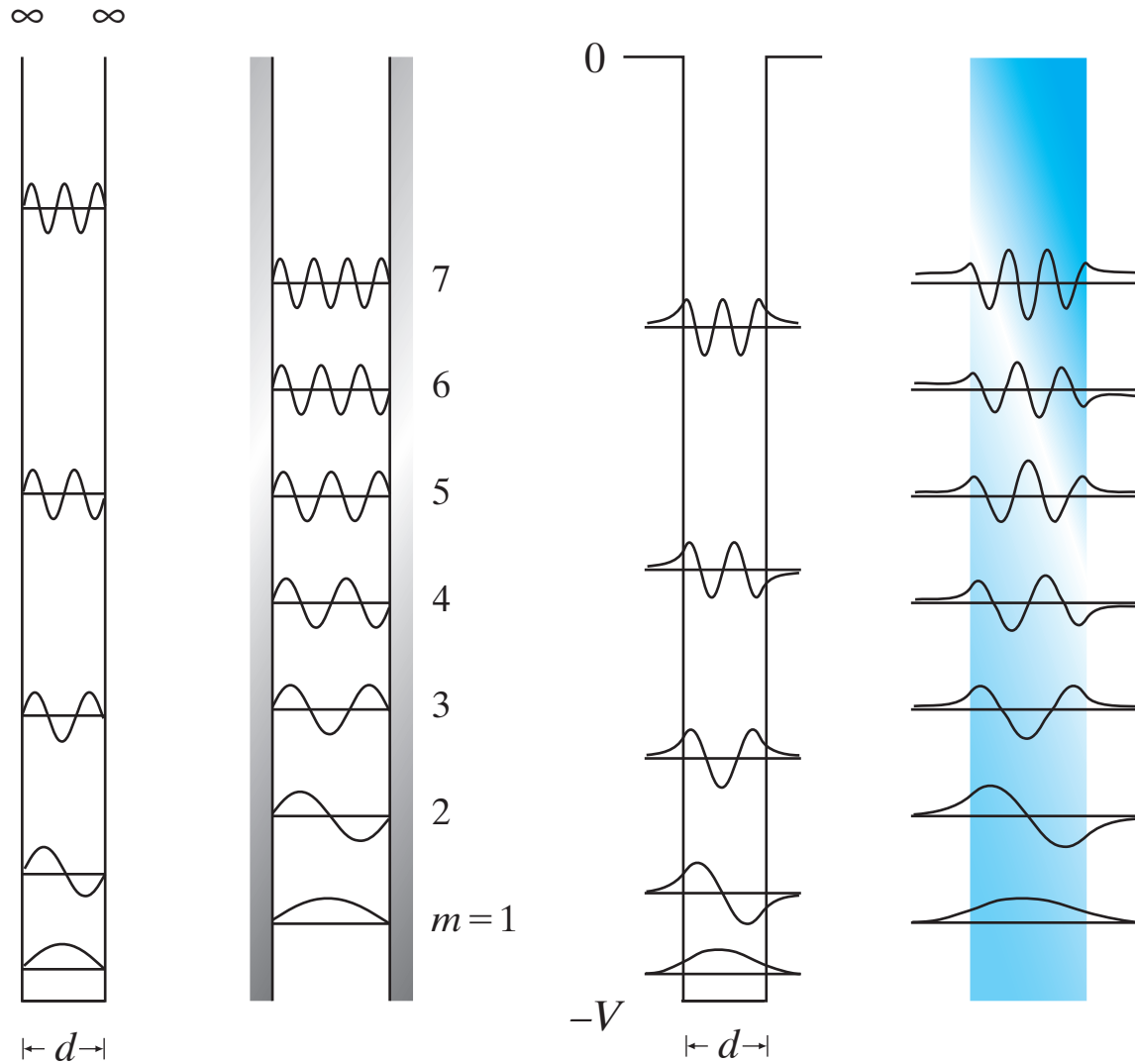

Waveguiding

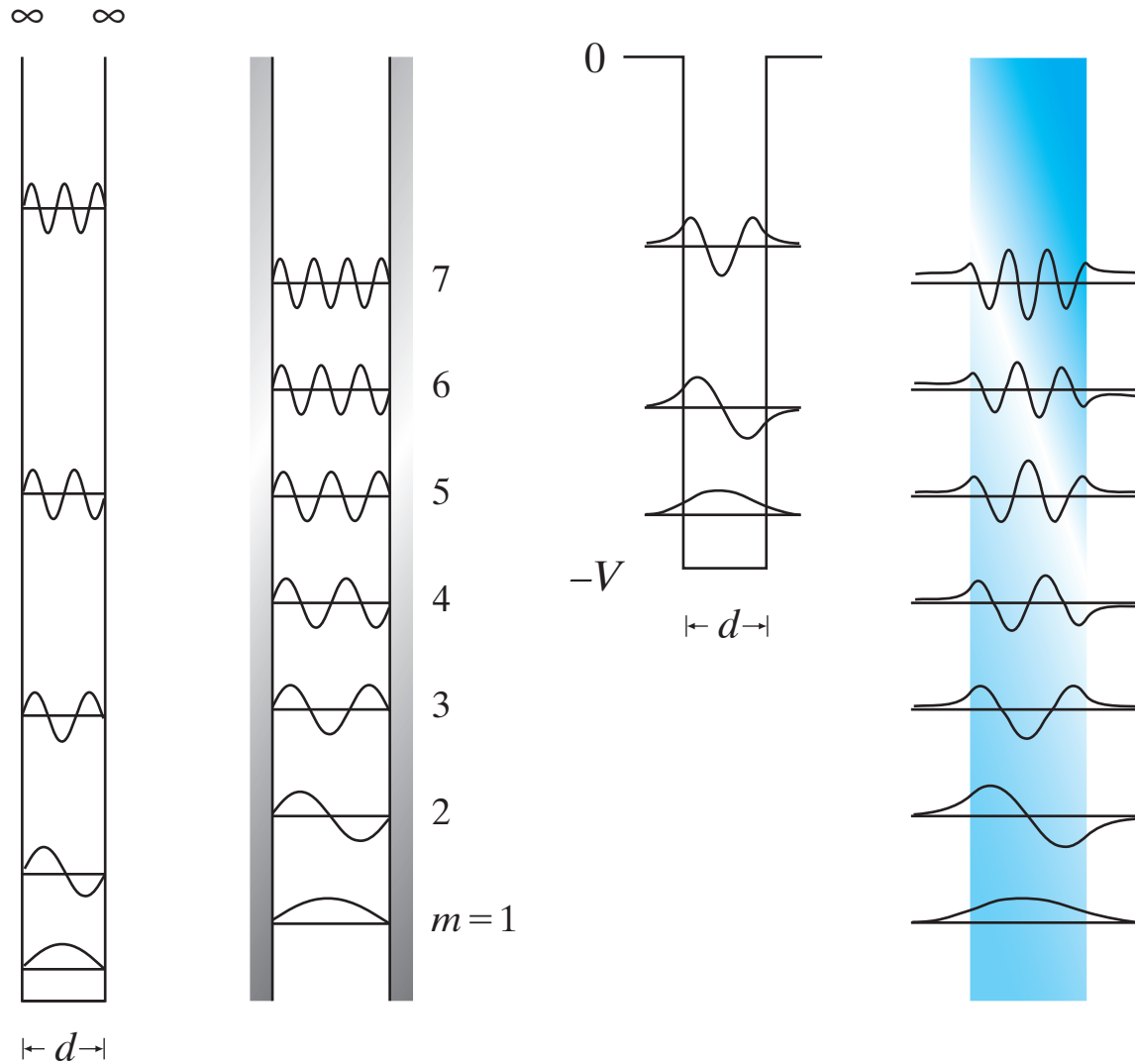

Waveguiding

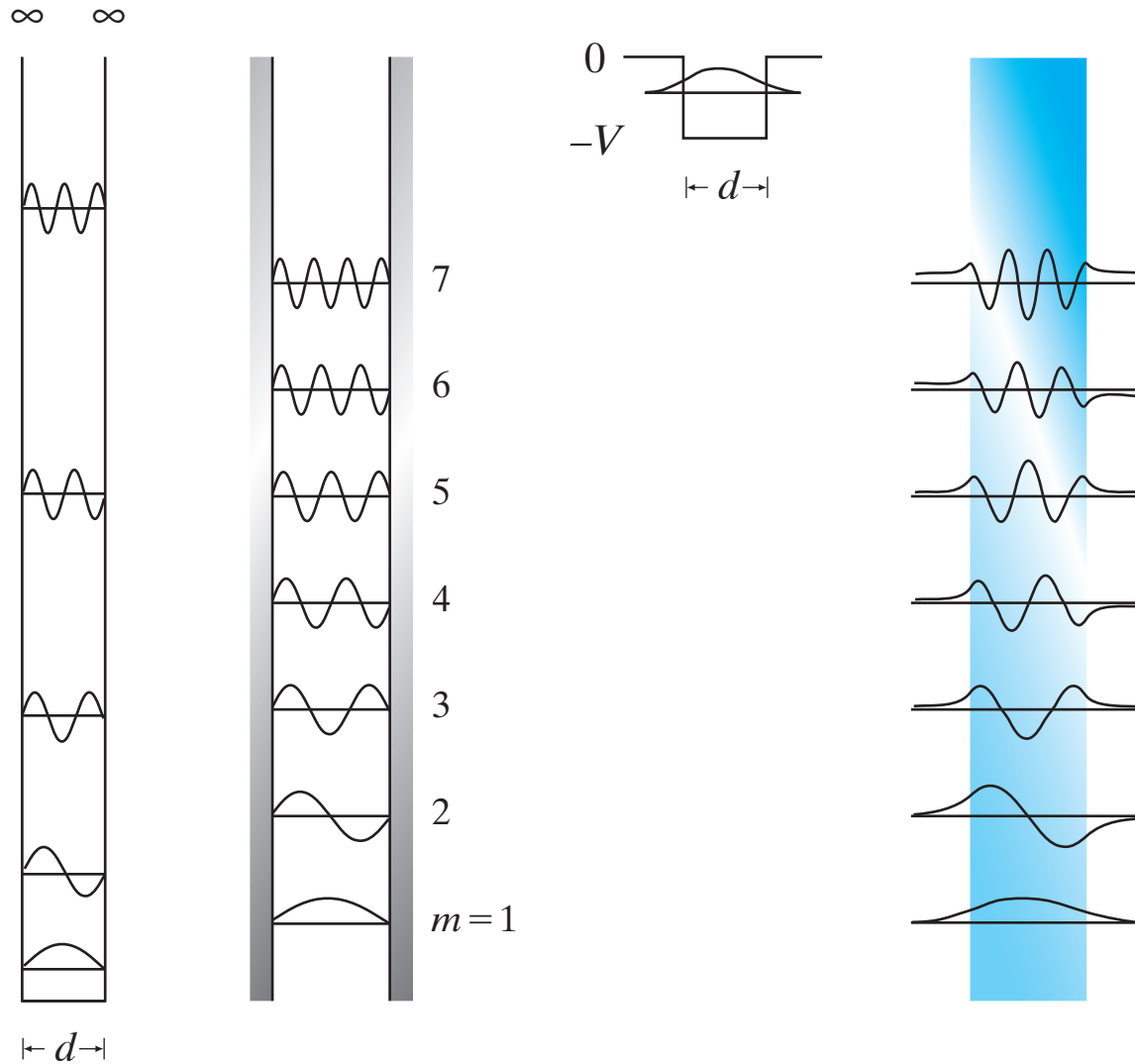

Waveguiding

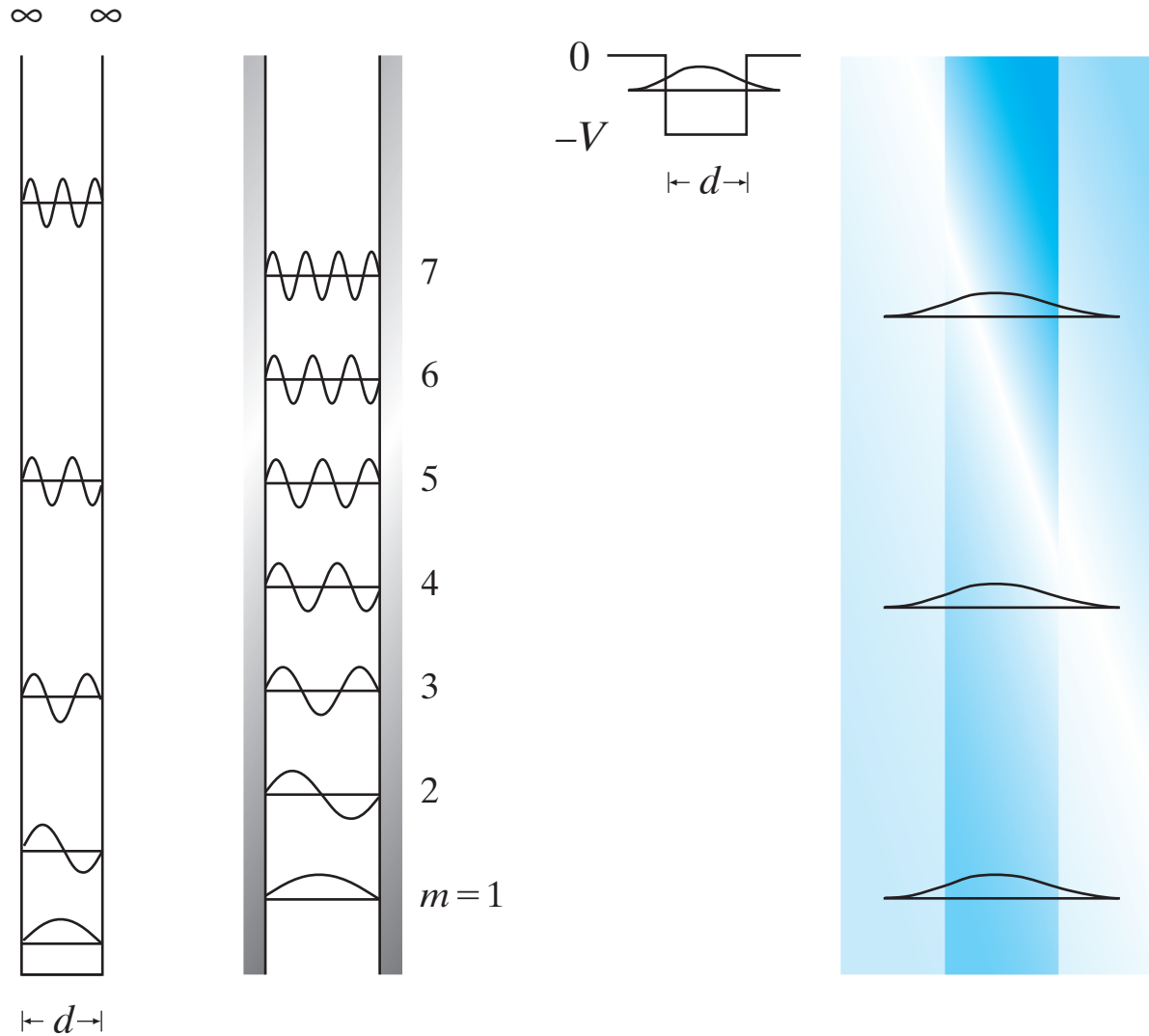

Waveguiding

single mode condition for 600-nm light:

$$M \doteq 2 \frac{d}{\lambda} (n_1^2 - n_2^2)^{1/2}$$

without cladding:

$$d < 268 \text{ nm}$$

Add cladding with 0.4% index difference:

$$d < 5 \text{ } \mu\text{m}$$

Waveguiding

commercial single-mode fiber (Corning Titan[®])



	core	cladding
index	$n_1 = 1.468$	$n_2 = 1.462$
diameter:	$8.3 \mu\text{m}$	$125.0 \pm 1.0 \mu\text{m}$

operating wavelength: $\lambda = 1310 \text{ nm}/1550 \text{ nm}$

Waveguiding

drawbacks of clad fibers:

- **weak confinement**
- **no tight bending**
- **coupling requires splicing**

Outline

- waveguiding
- **silica nanowires**
- manipulating light at the nanoscale
- nanoscale nonlinear optics

Silica nanowires

two-step drawing process

standard
fiber



Silica nanowires

two-step drawing process

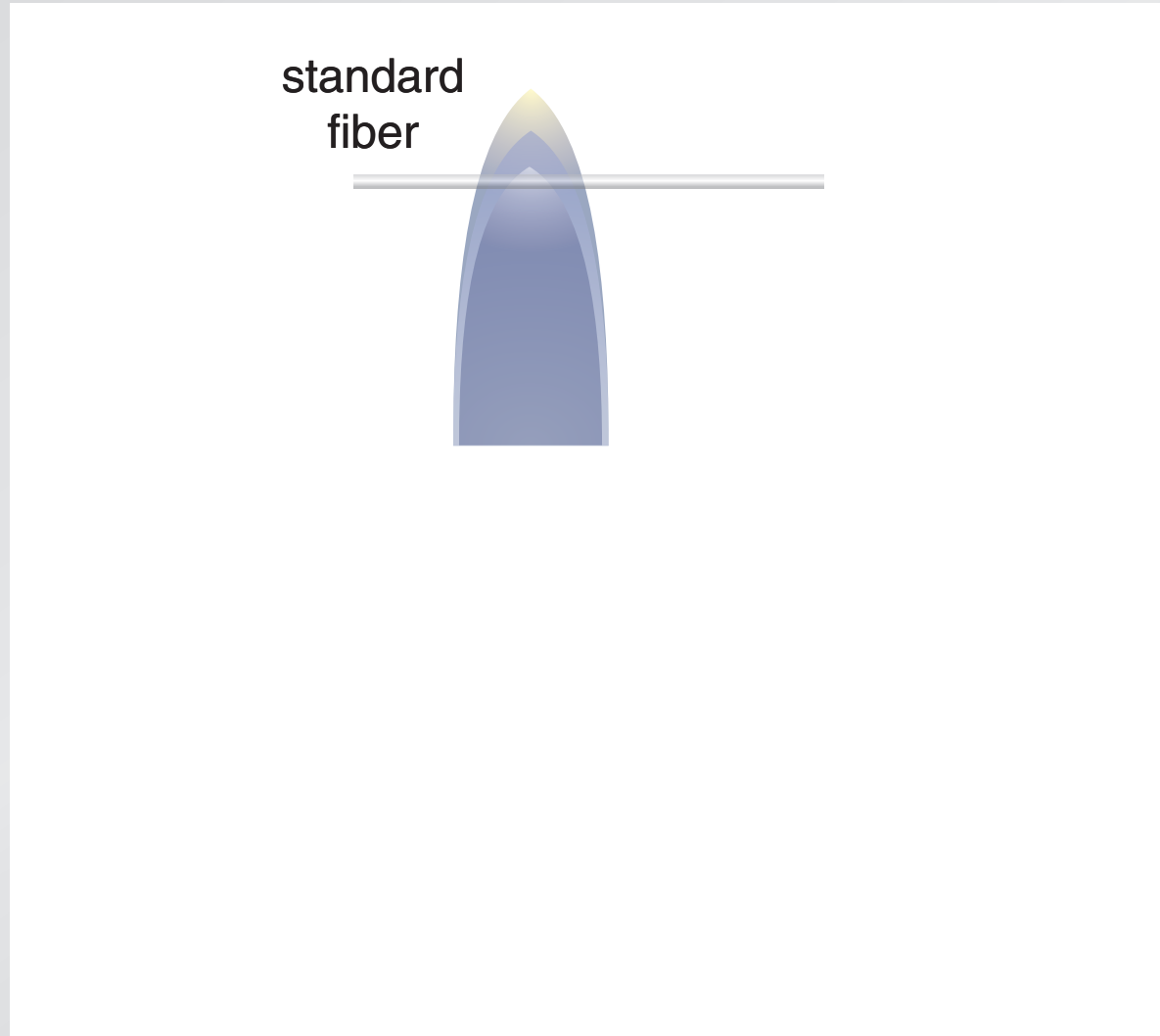

Silica nanowires

two-step drawing process

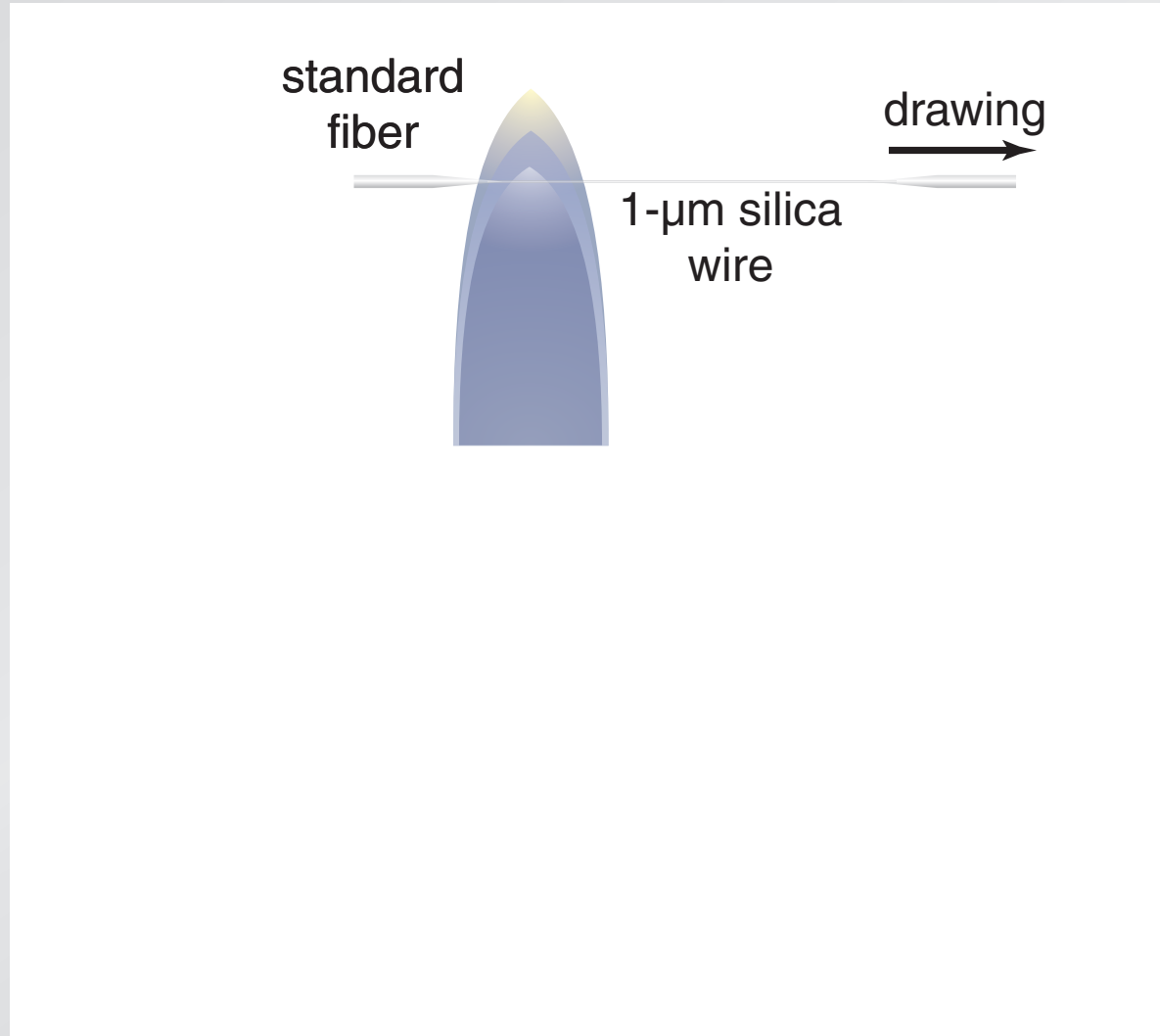

Silica nanowires

two-step drawing process

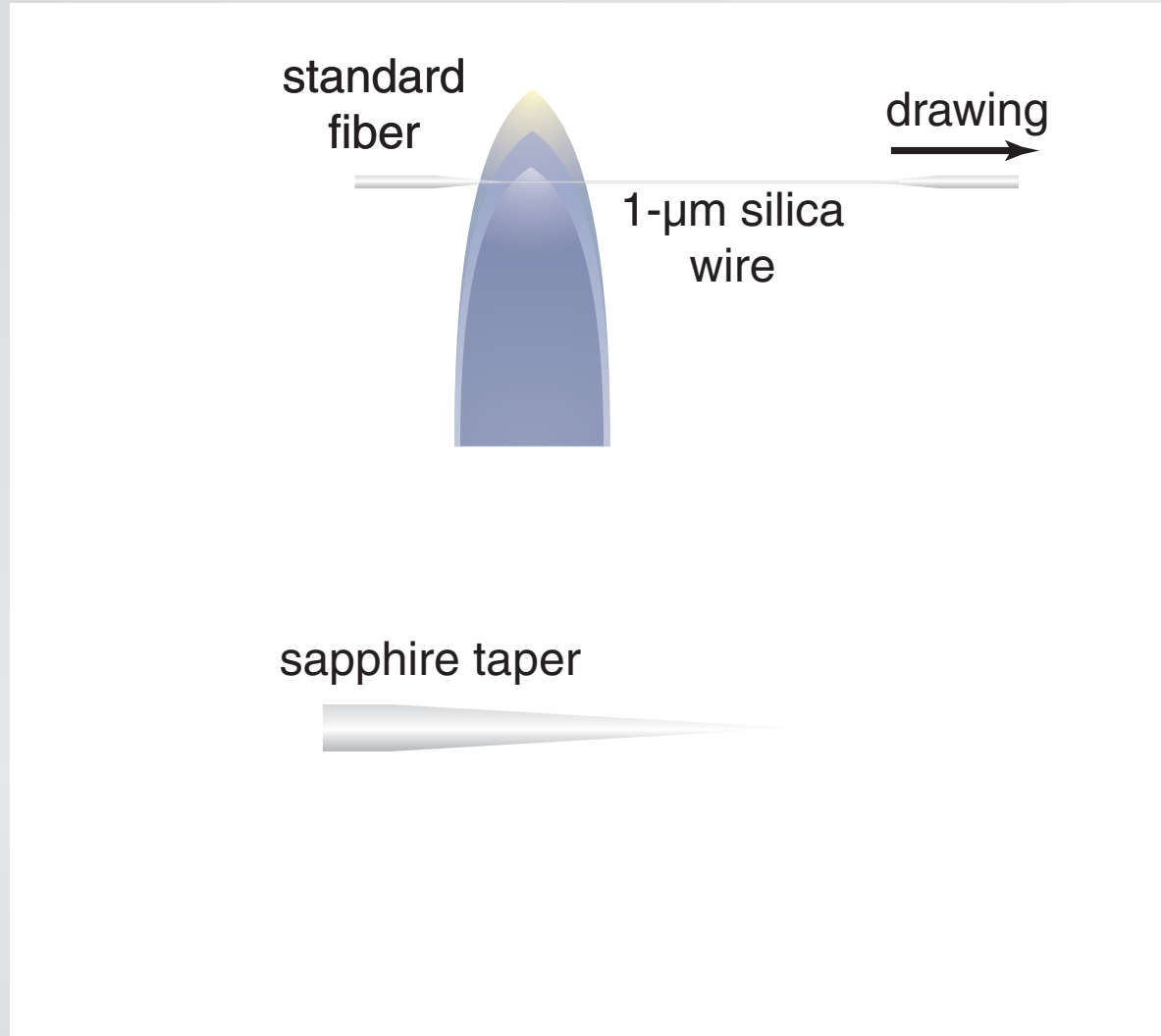

Silica nanowires

two-step drawing process

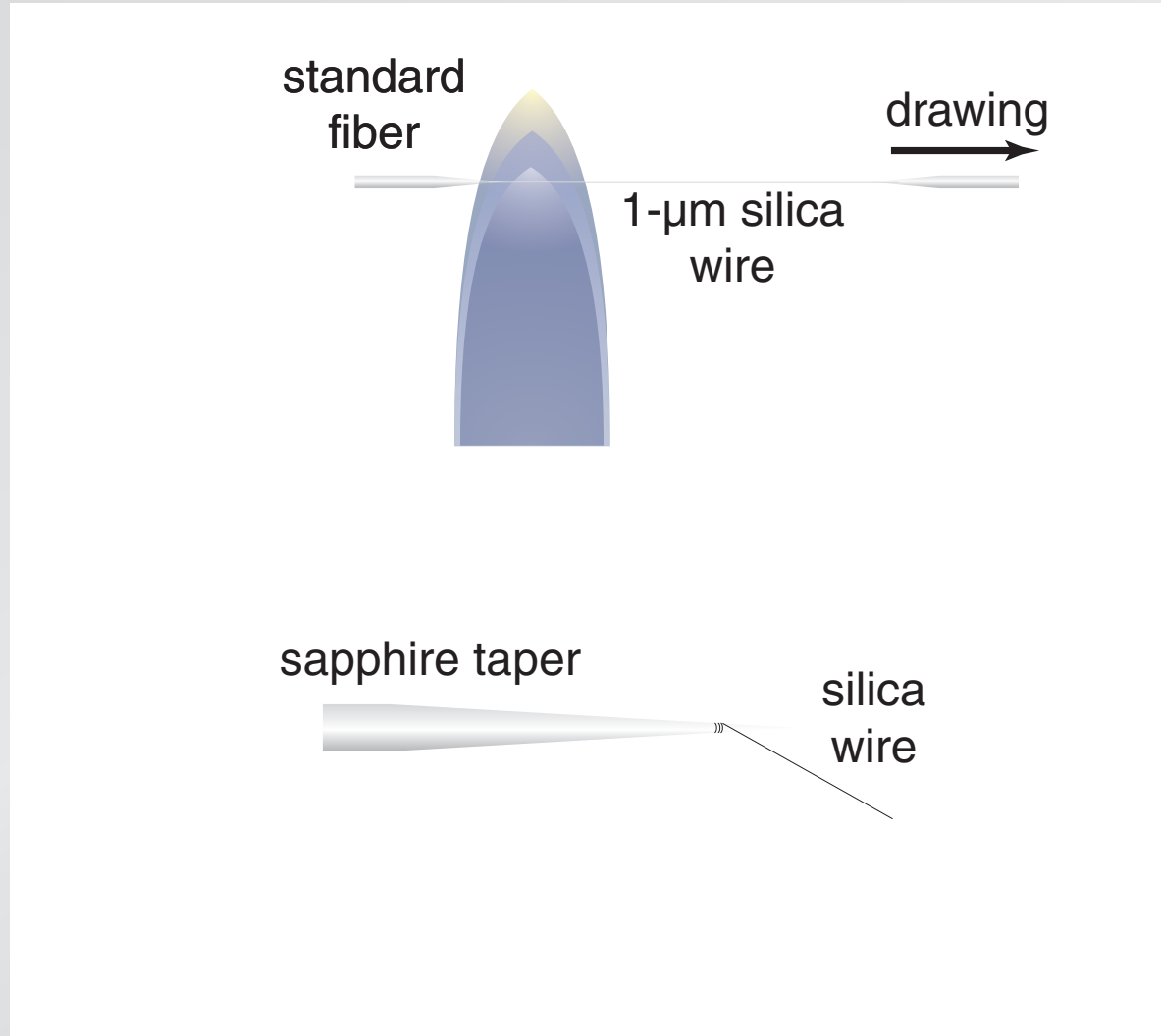

Silica nanowires

two-step drawing process

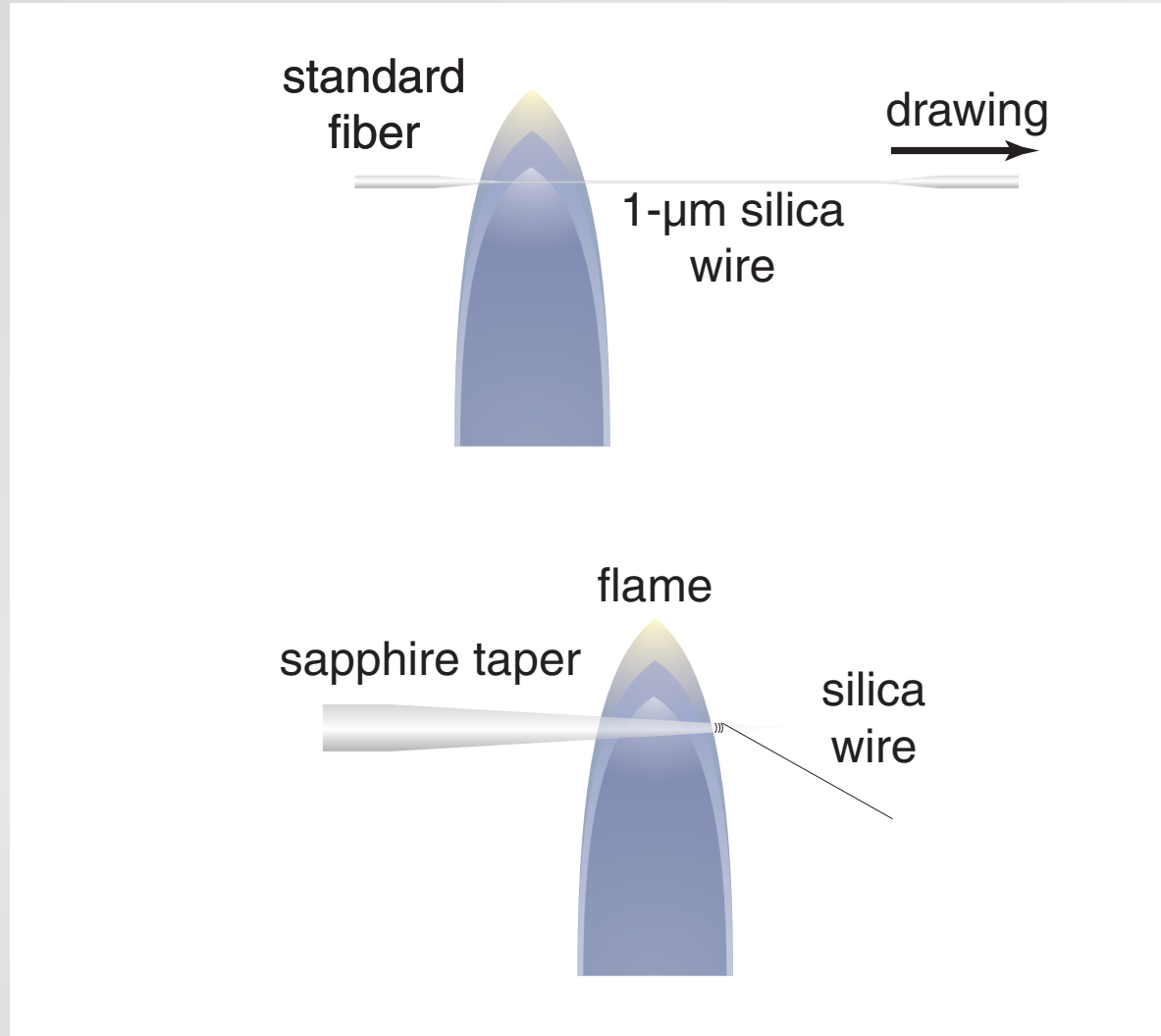

Silica nanowires

two-step drawing process

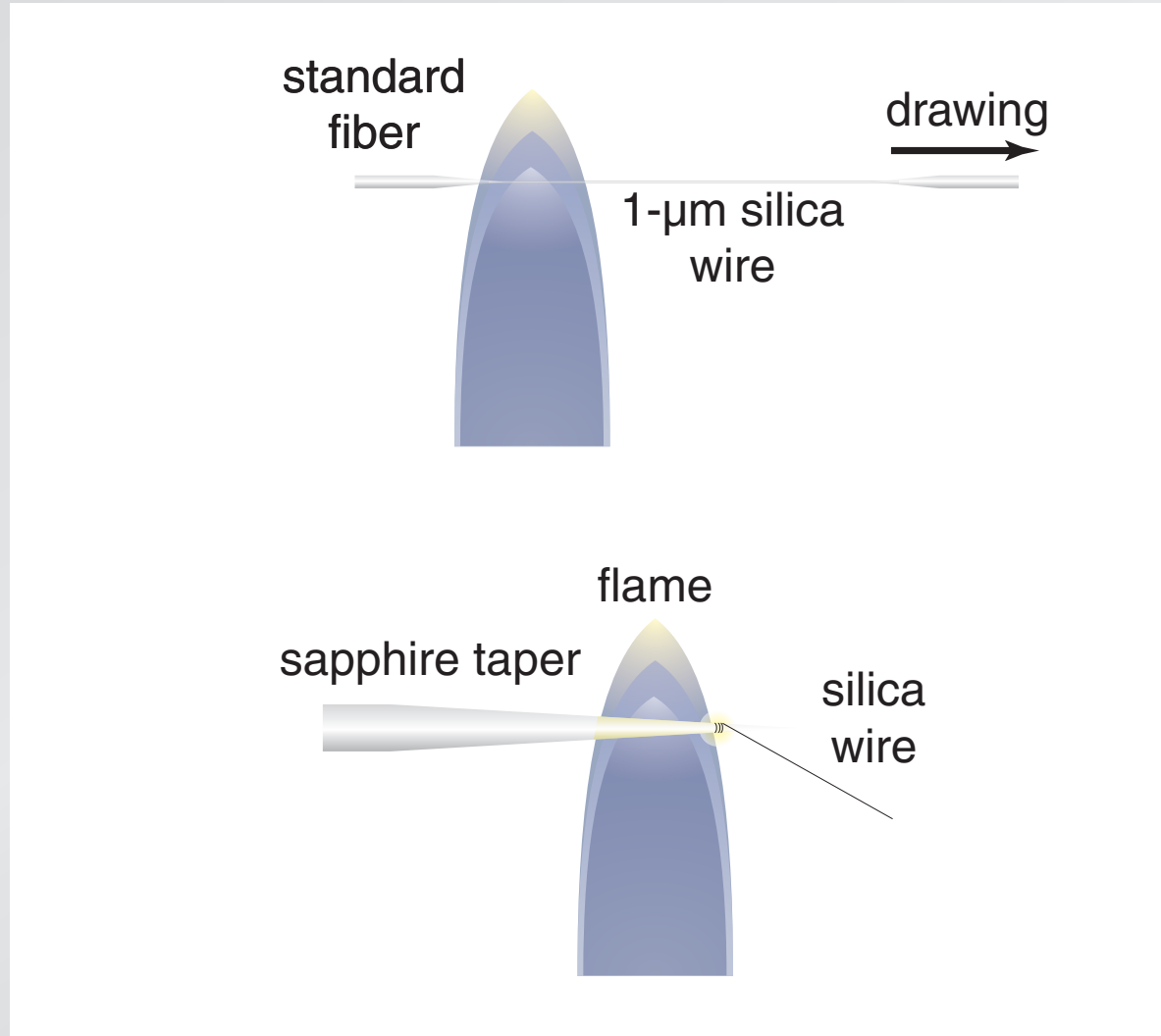

Silica nanowires

two-step drawing process

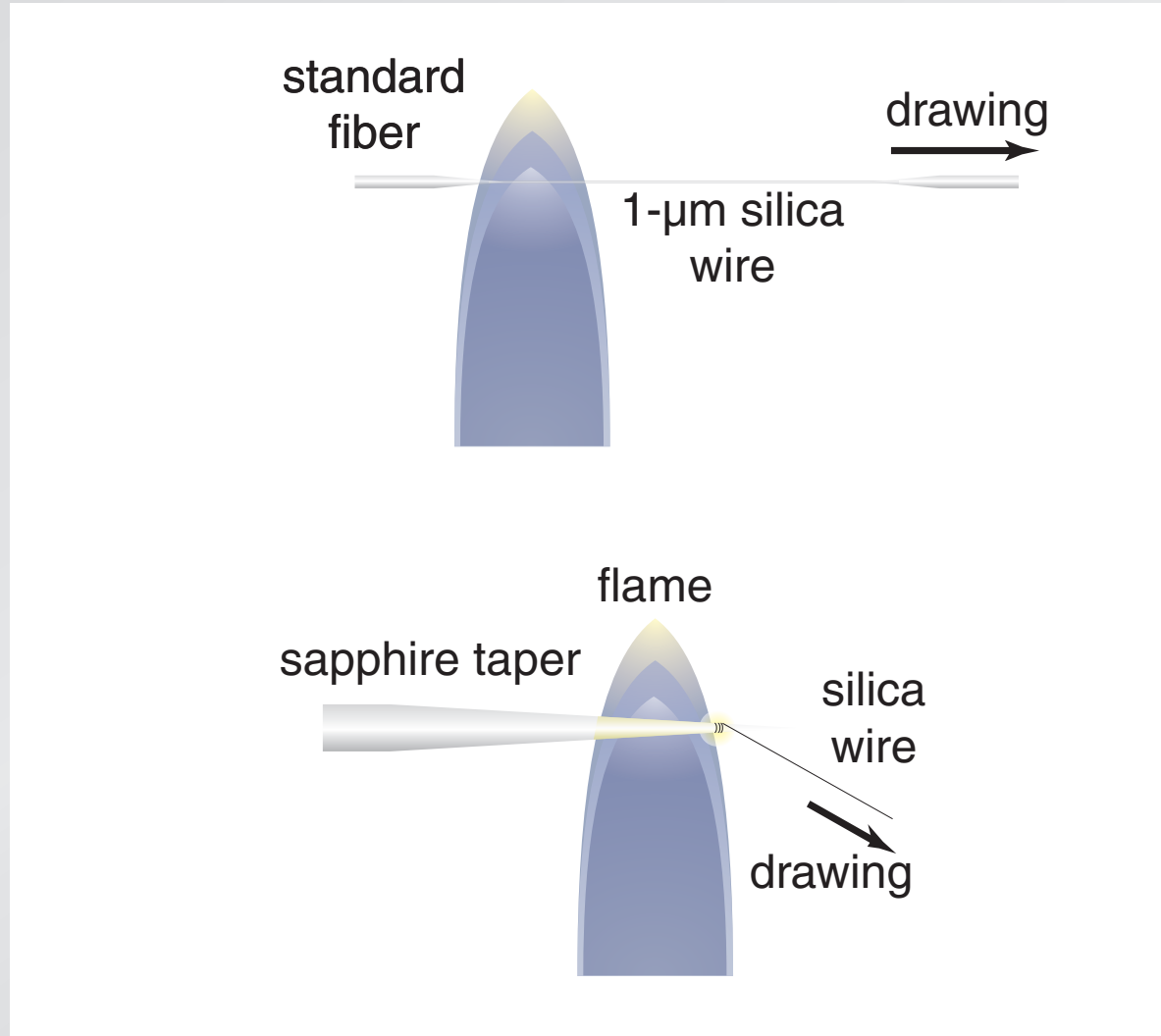

Silica nanowires

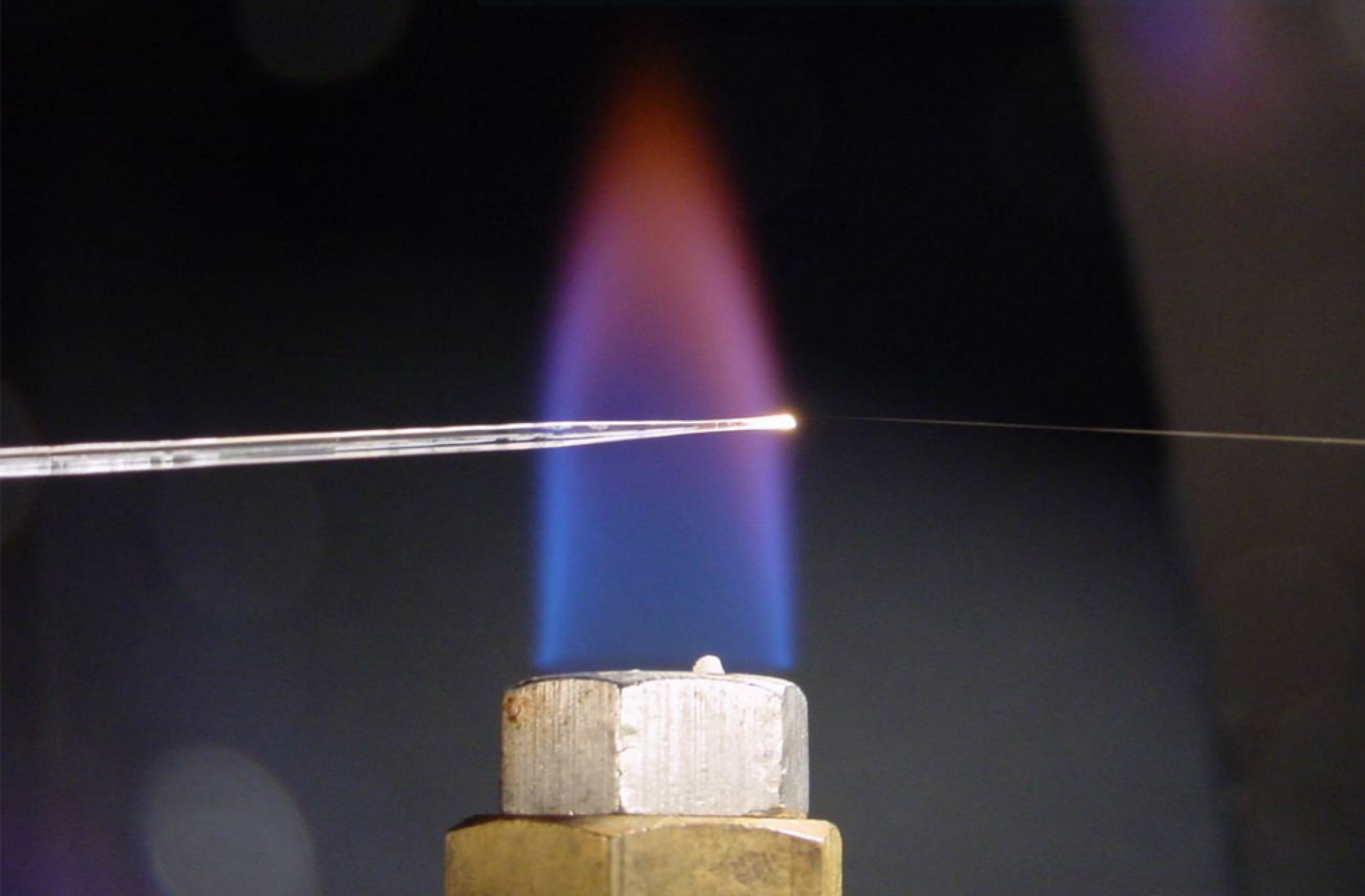

Silica nanowires

1 μm



Nature, 426, 816 (2003)

Silica nanowires

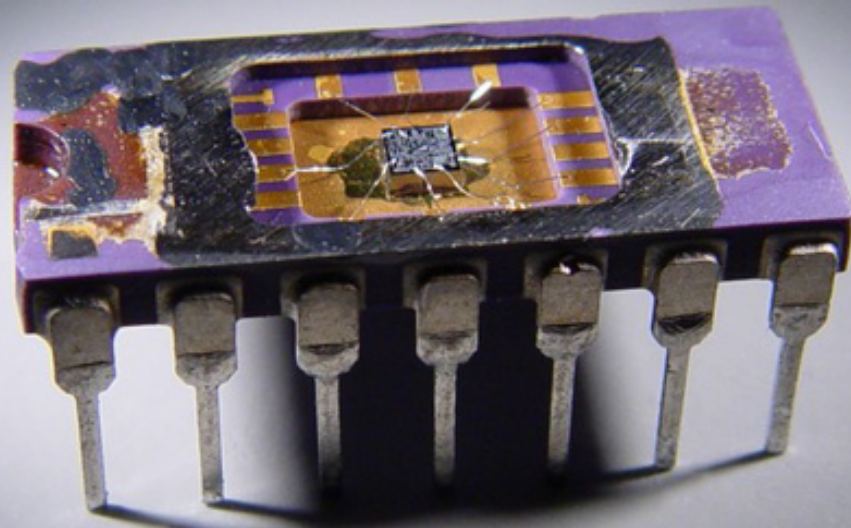

Silica nanowires

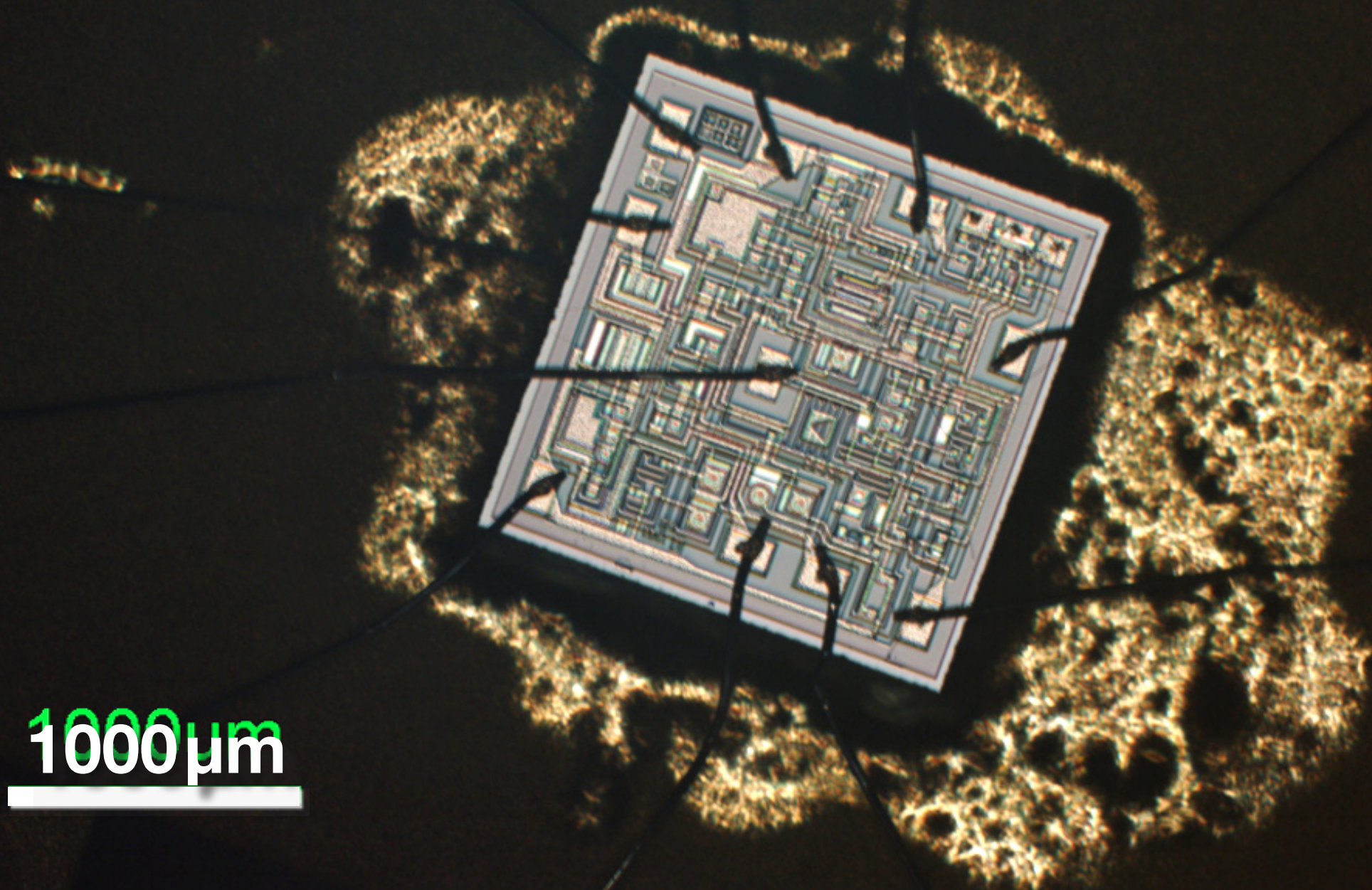

Silica nanowires

500 μm

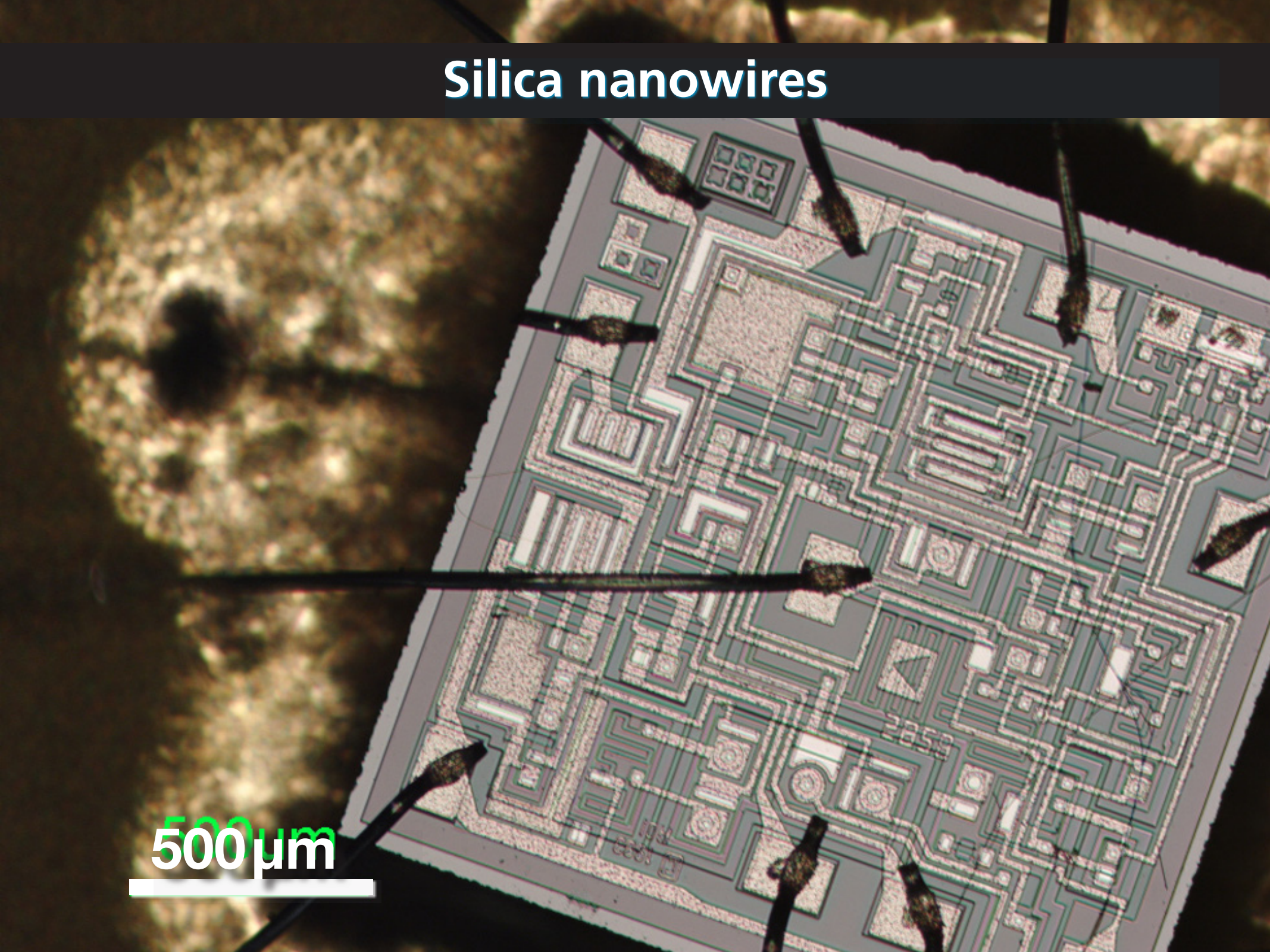
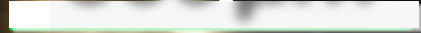

Silica nanowires

200 μm

A scanning electron micrograph (SEM) of a silicon chip. The chip surface is covered with a complex pattern of microstructures, including various rectangular and circular features, likely representing different components of a microchip. Two long, thin, dark structures, identified as silica nanowires, are positioned across the chip. One nanowire is oriented vertically, and the other is oriented horizontally. A scale bar in the bottom left corner indicates a length of 200 micrometers.

Silica nanowires

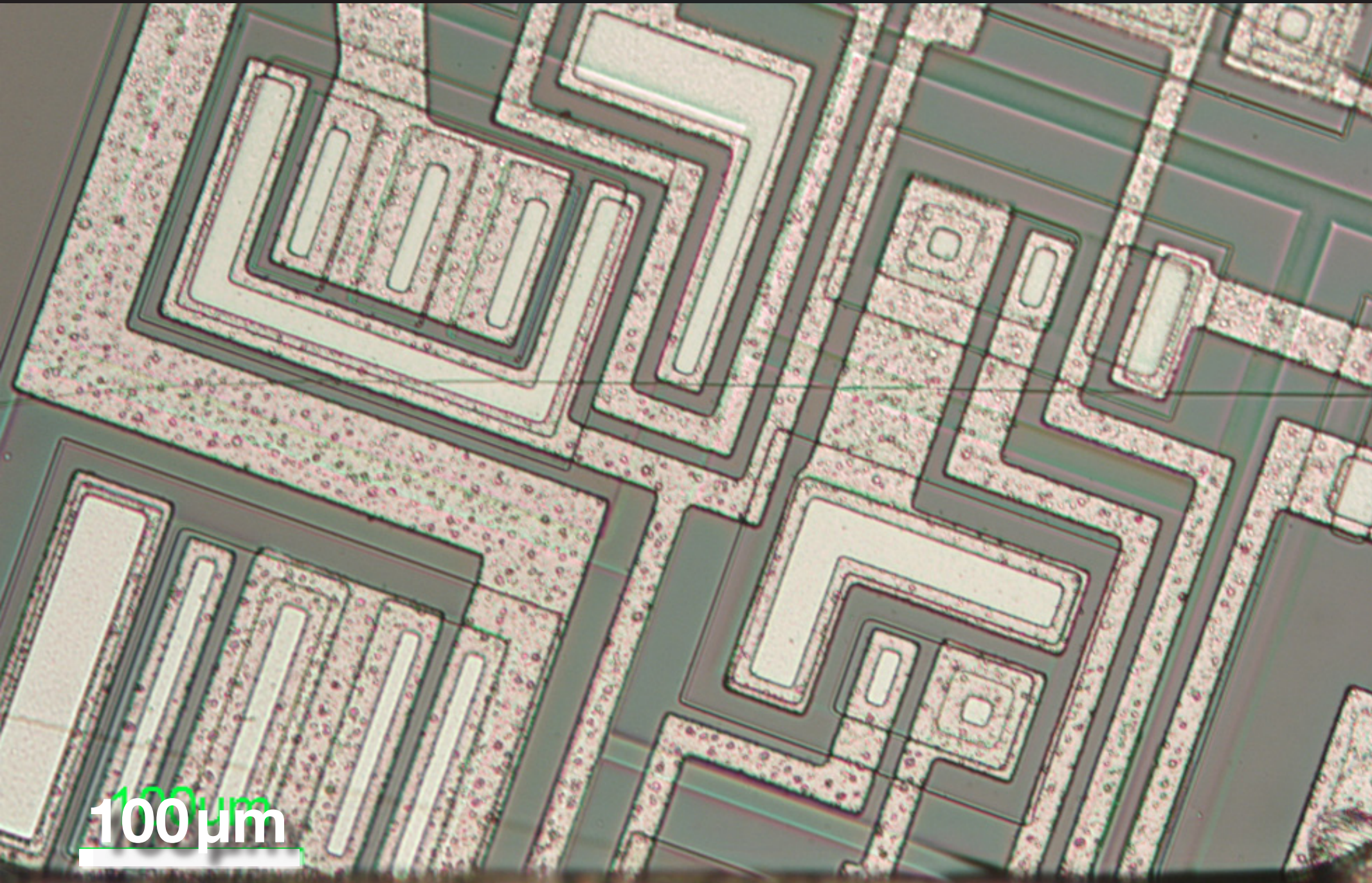

100 μm

Silica nanowires

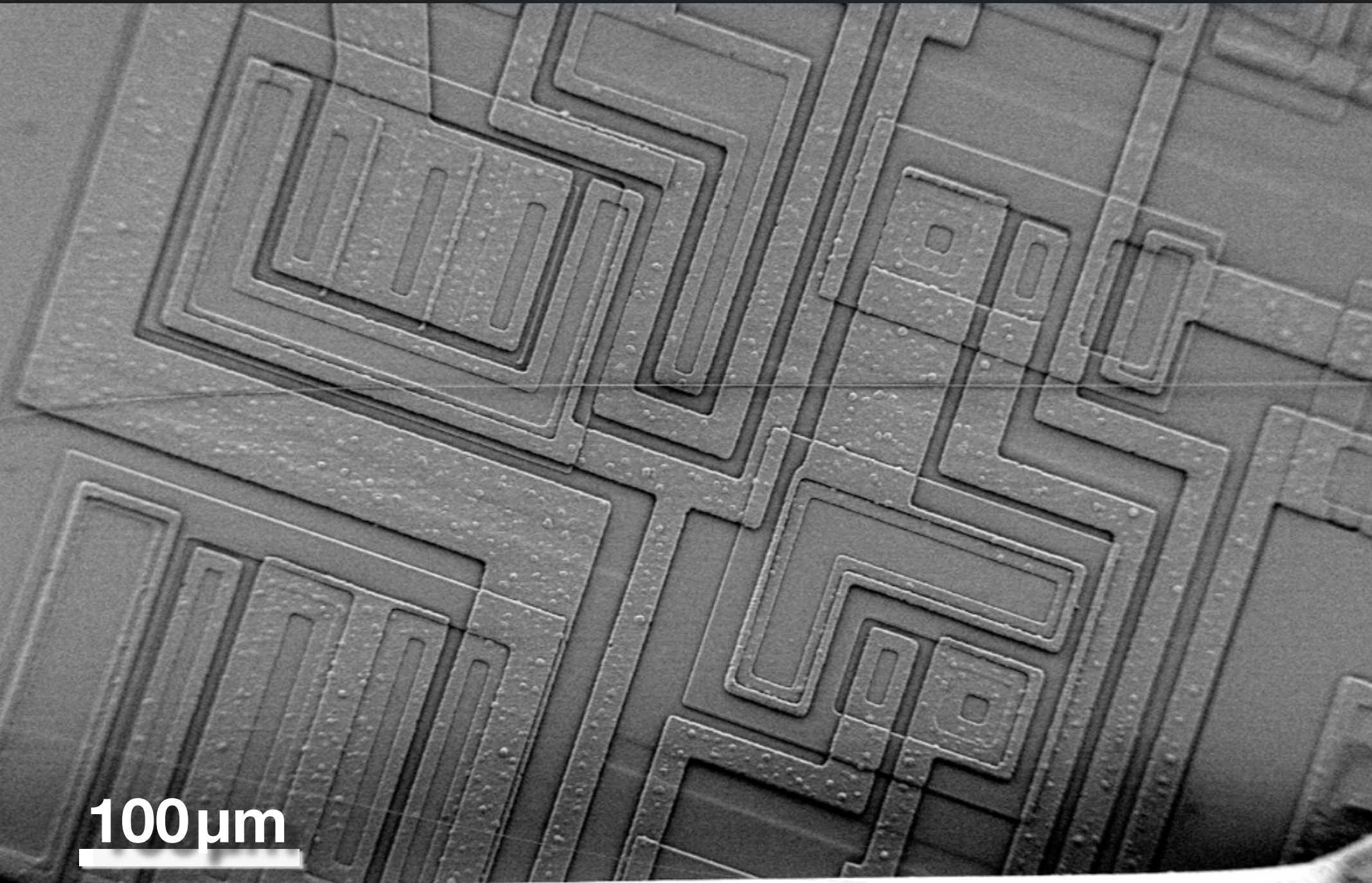

Silica nanowires

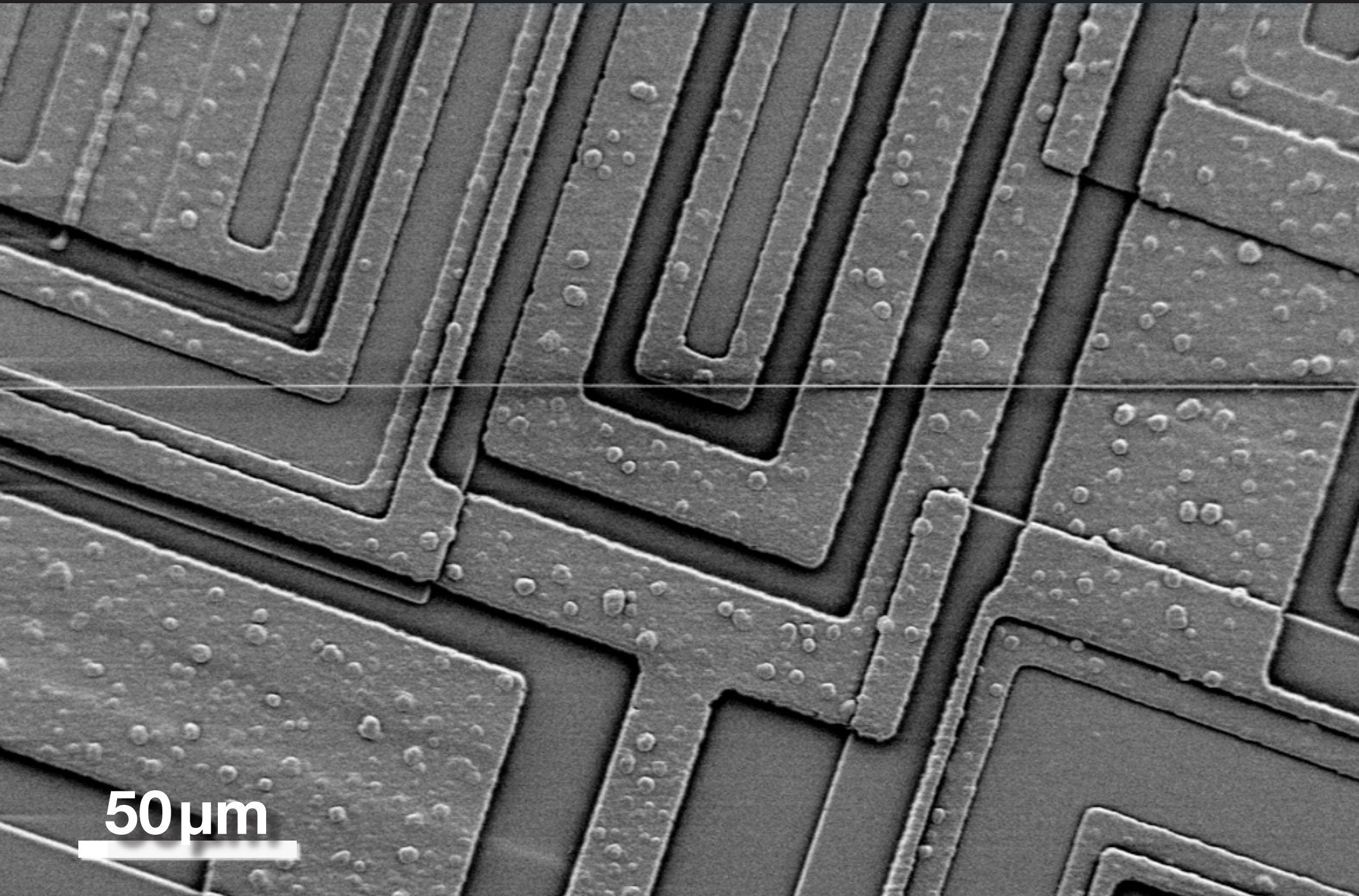

50 μm

Silica nanowires

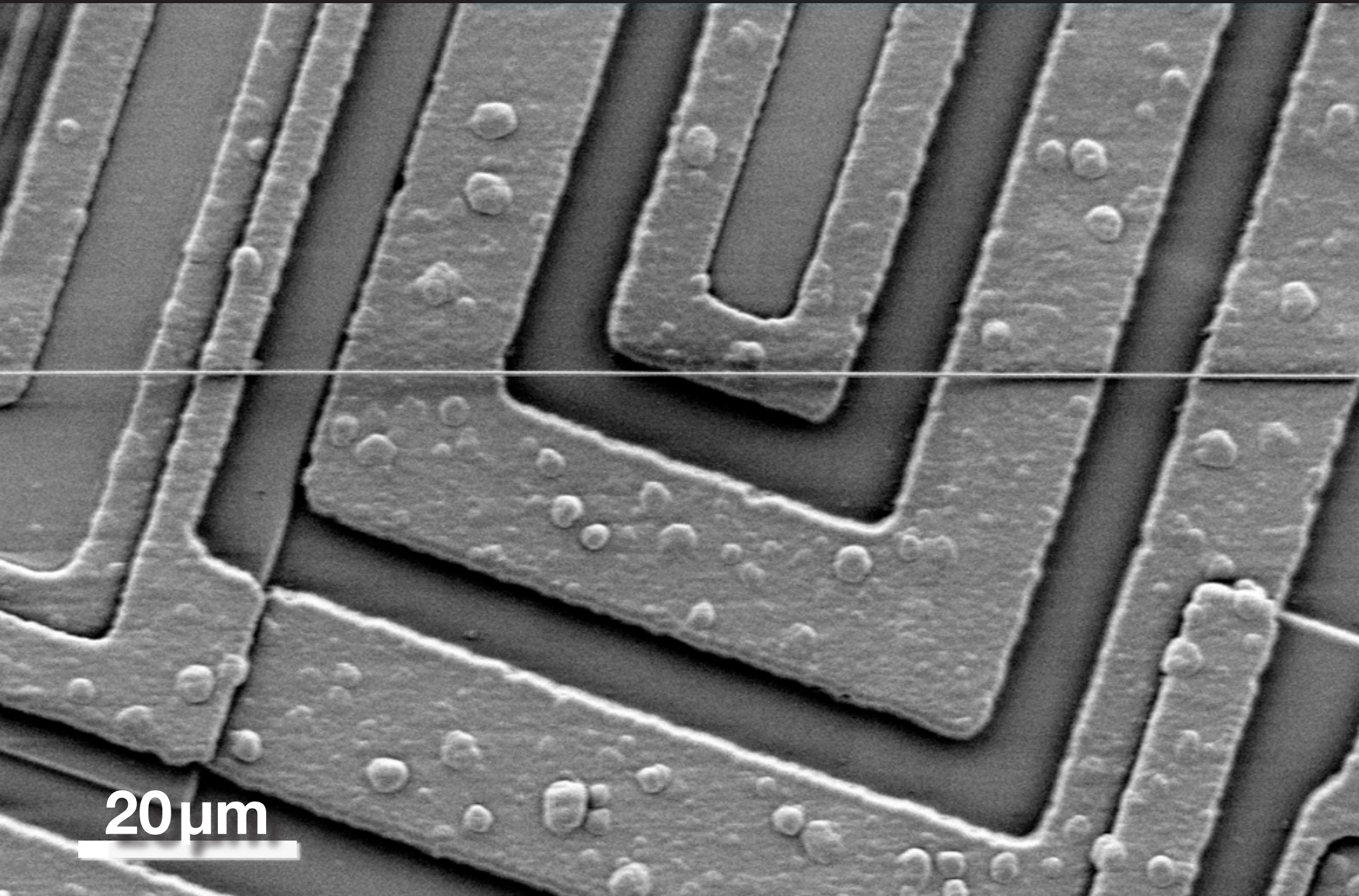

20 μm

Silica nanowires

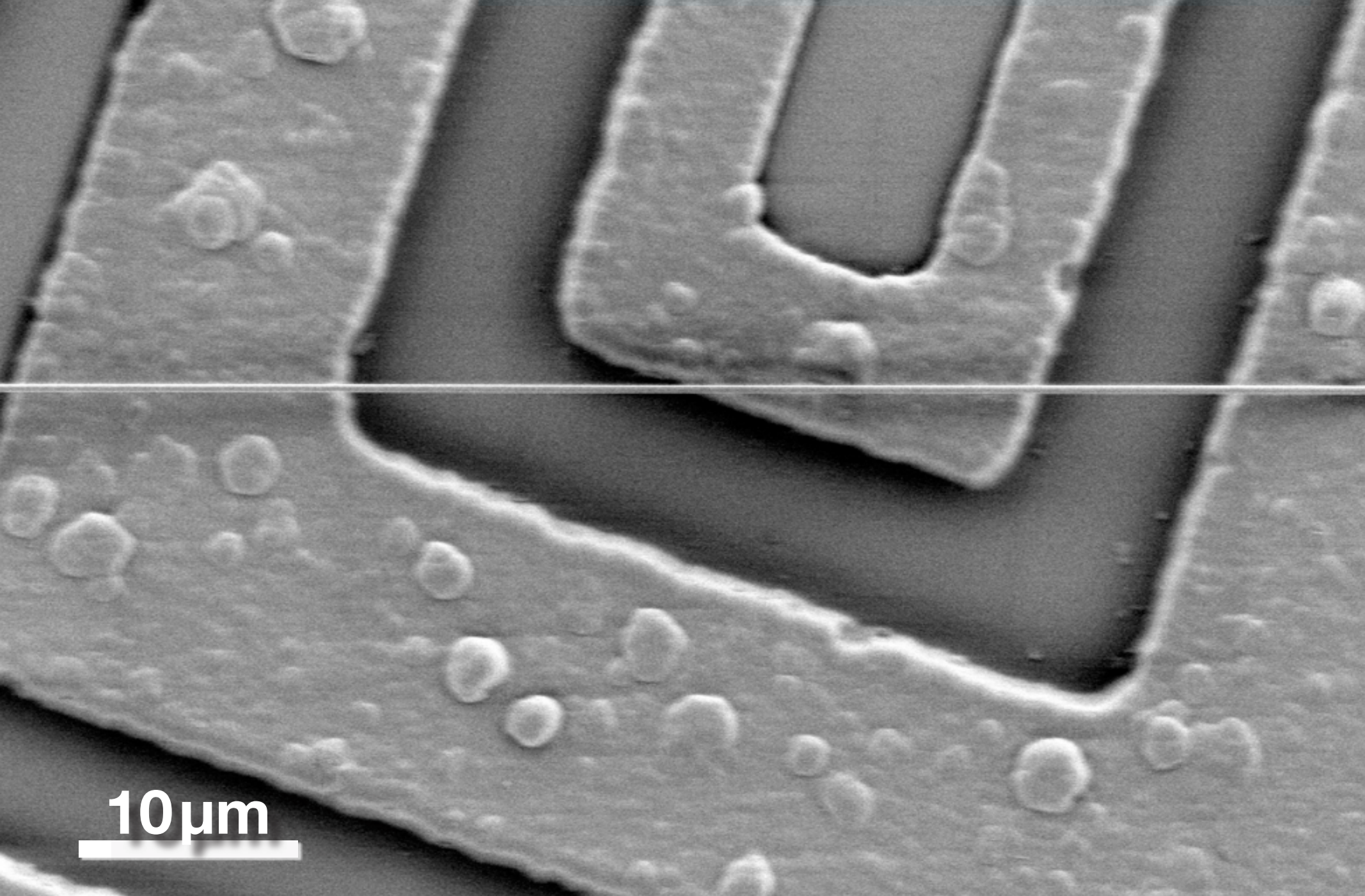

10 μm

Silica nanowires

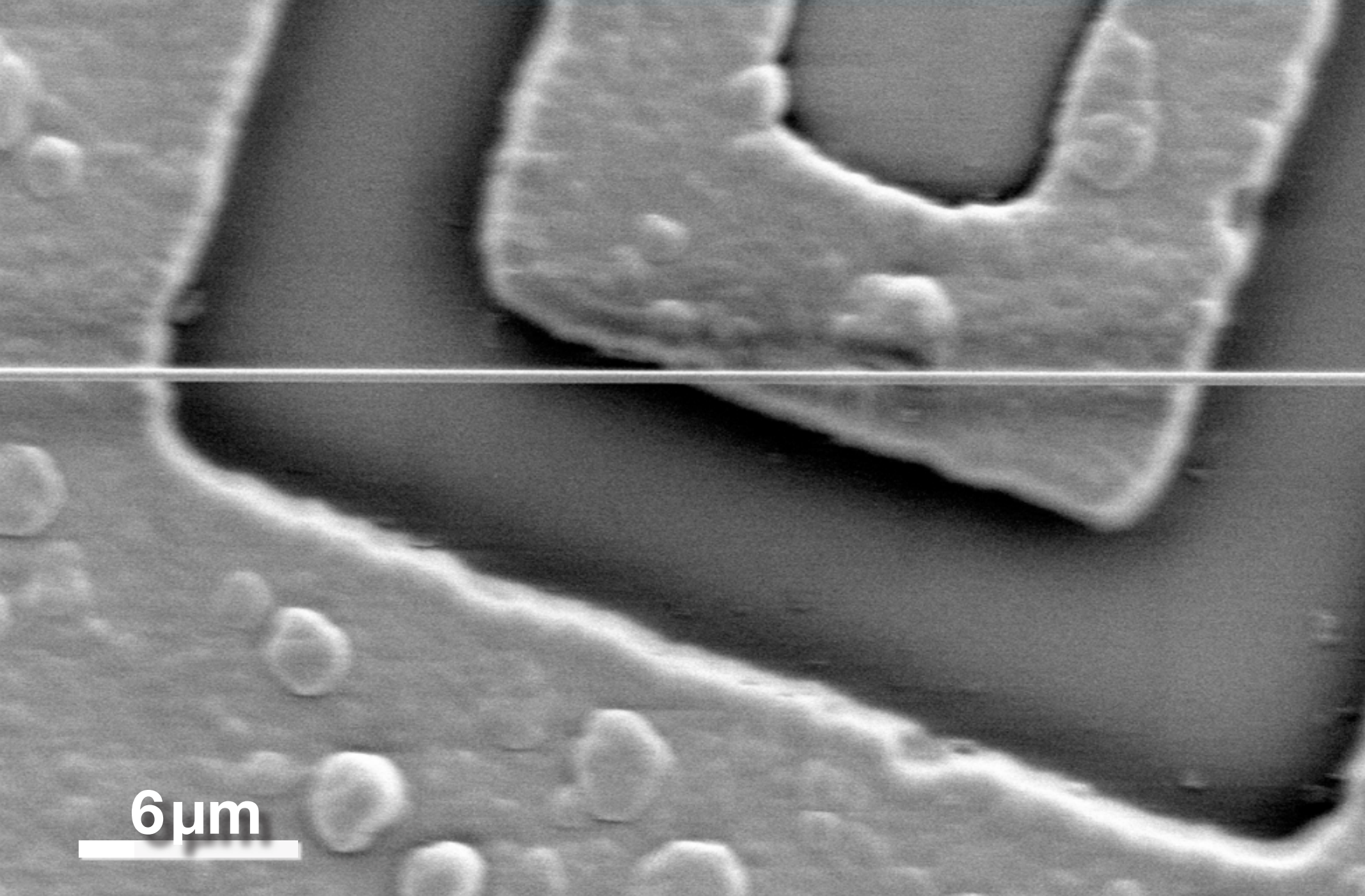

6 μm

Silica nanowires

4 μm

This scanning electron microscope (SEM) image displays silica nanowires. A single, thin nanowire is clearly visible, extending horizontally across the middle of the frame. The background shows a textured surface, likely the substrate or other nanowires, with some larger, irregular features. A scale bar in the bottom left corner indicates a length of 4 micrometers.

Silica nanowires

2 μm

A grayscale micrograph showing a single, long, thin silica nanowire oriented horizontally across the center of the frame. The nanowire is very uniform in thickness and extends across most of the width of the image. In the bottom-left corner, there is a white horizontal scale bar with the text "2 μm" positioned above it.

Silica nanowires

312 nm

A transmission electron micrograph (TEM) showing a single, long, cylindrical silica nanowire. The nanowire is oriented horizontally and appears as a bright, uniform line against a dark background. A vertical white line with a crossbar at the bottom is drawn across the nanowire to indicate its diameter. The text "312 nm" is placed above this vertical line. In the bottom left corner, there is a white horizontal scale bar with the text "1 μm" above it.

1 μm

Silica nanowires

Specifications

diameter D : down to 20 nm

length L : up to 90 mm

aspect ratio D/L : up to 10^6

diameter uniformity $\Delta D/L$: 2×10^{-6}

Silica nanowires

$d = 260 \text{ nm}$

$L = 4 \text{ mm}$

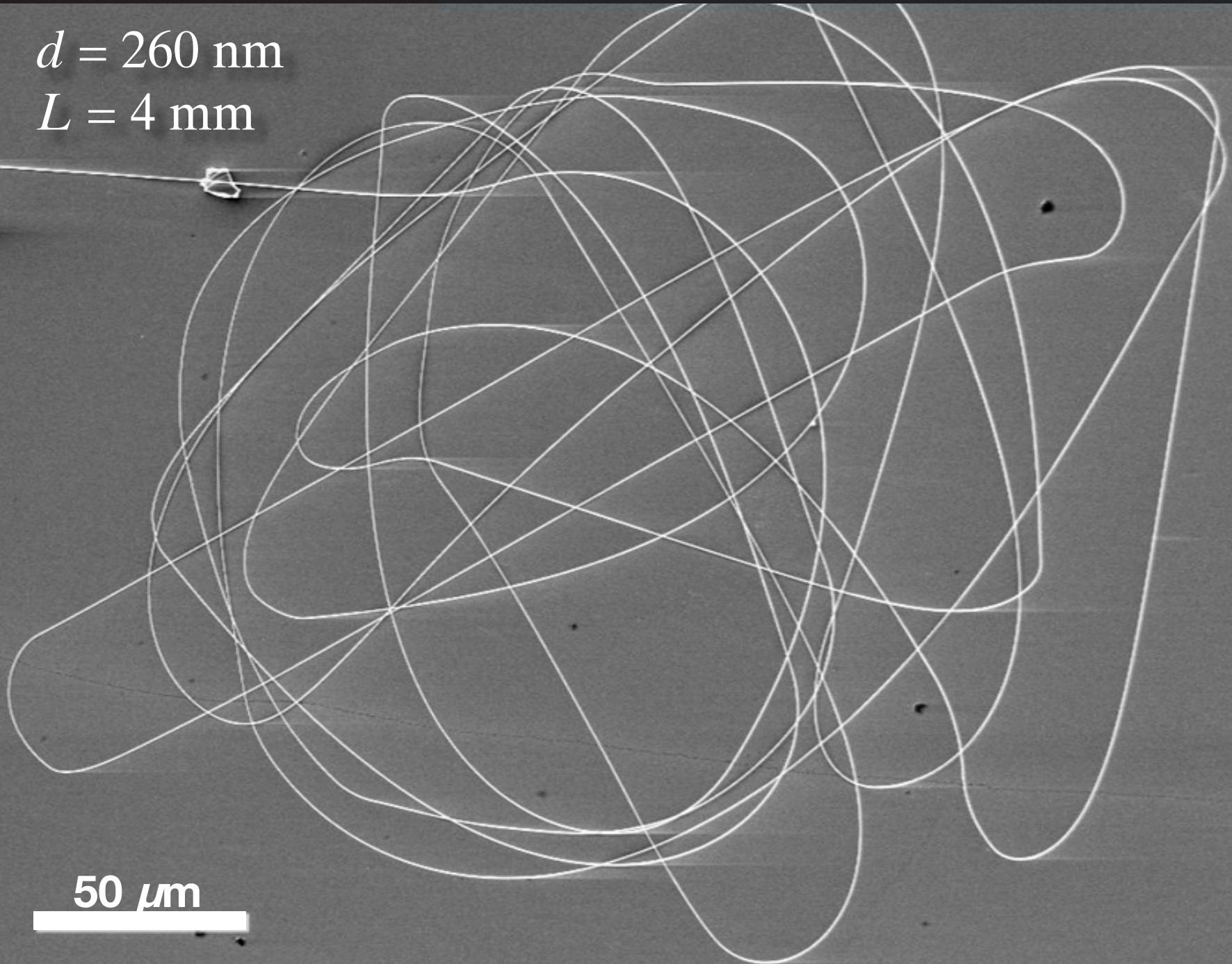

50 μm

Silica nanowires

240-nm wire

200 nm

A transmission electron micrograph showing a single, dark, cylindrical silica nanowire oriented diagonally from the bottom-left to the top-right. The wire has a uniform diameter and a smooth surface. The background is a light gray, textured surface. A scale bar in the bottom right corner indicates a length of 200 nm.

Silica nanowires

RMS roughness < 0.5 nm

20 nm



Silica nanowires



20 nm



Silica nanowires

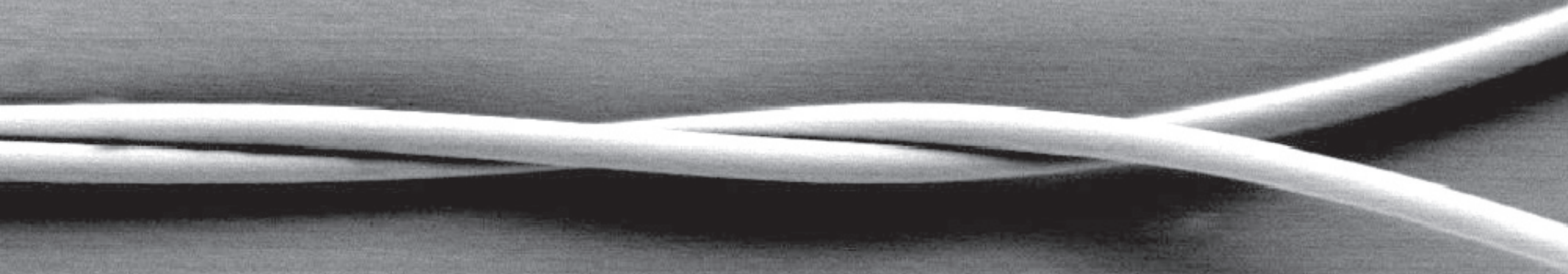

2 μm



Silica nanowires

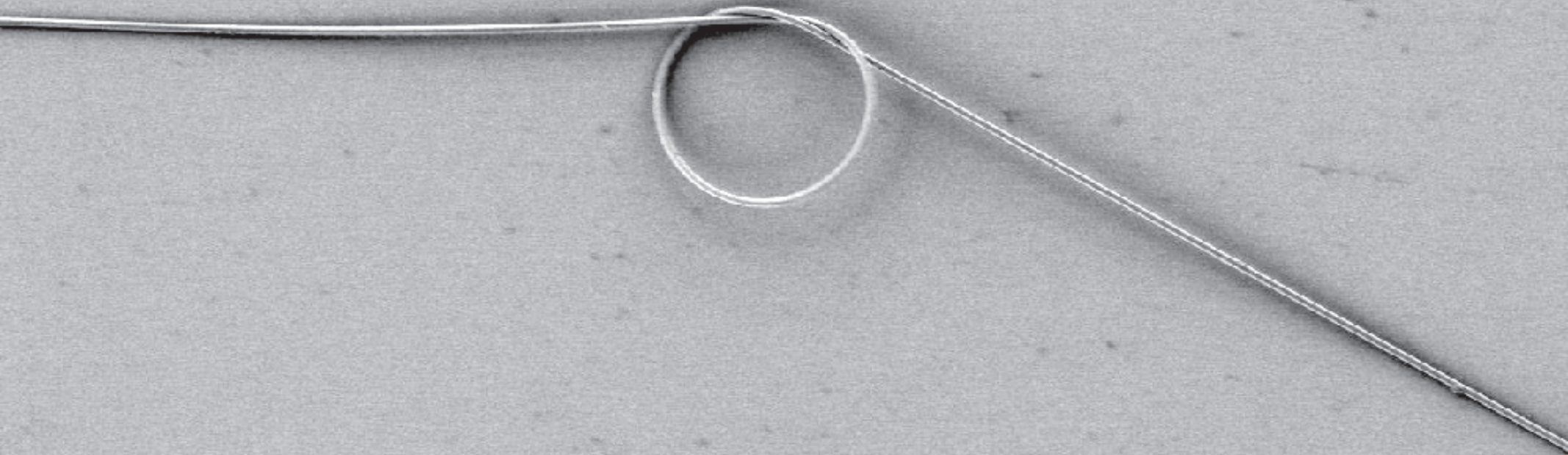

20 μm

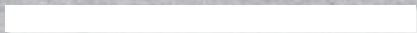

Silica nanowires

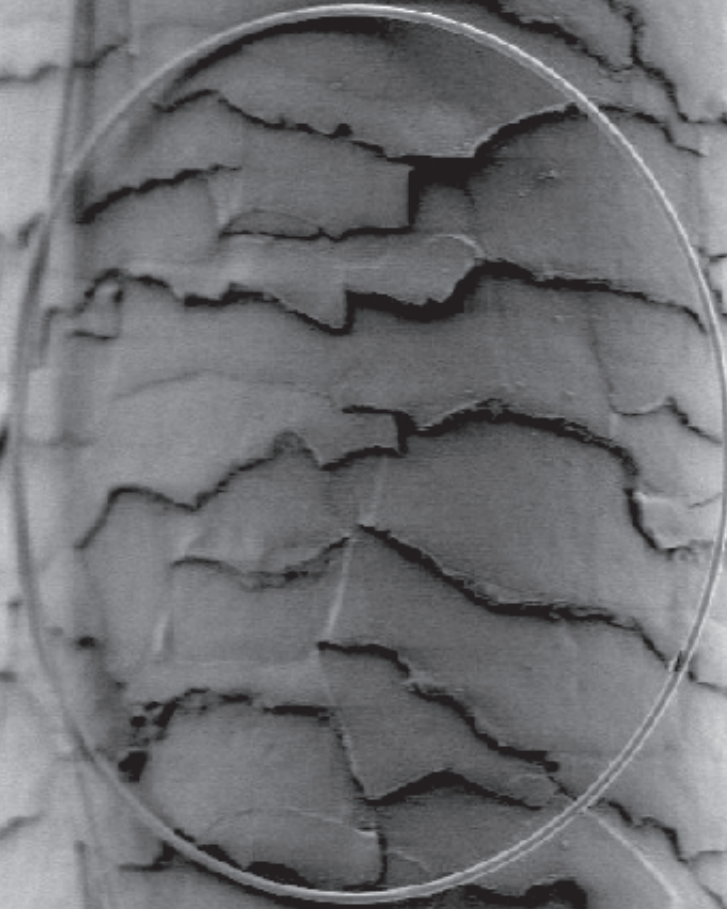

20 μm



Silica nanowires

Points to keep in mind:

- **easy fabrication**
- **atomic level smoothness**
- **malleable**

Outline

- waveguiding
- silica nanowires
- **manipulating light at the nanoscale**
- nanoscale nonlinear optics

Manipulating light at the nanoscale

coupling light into nanowires

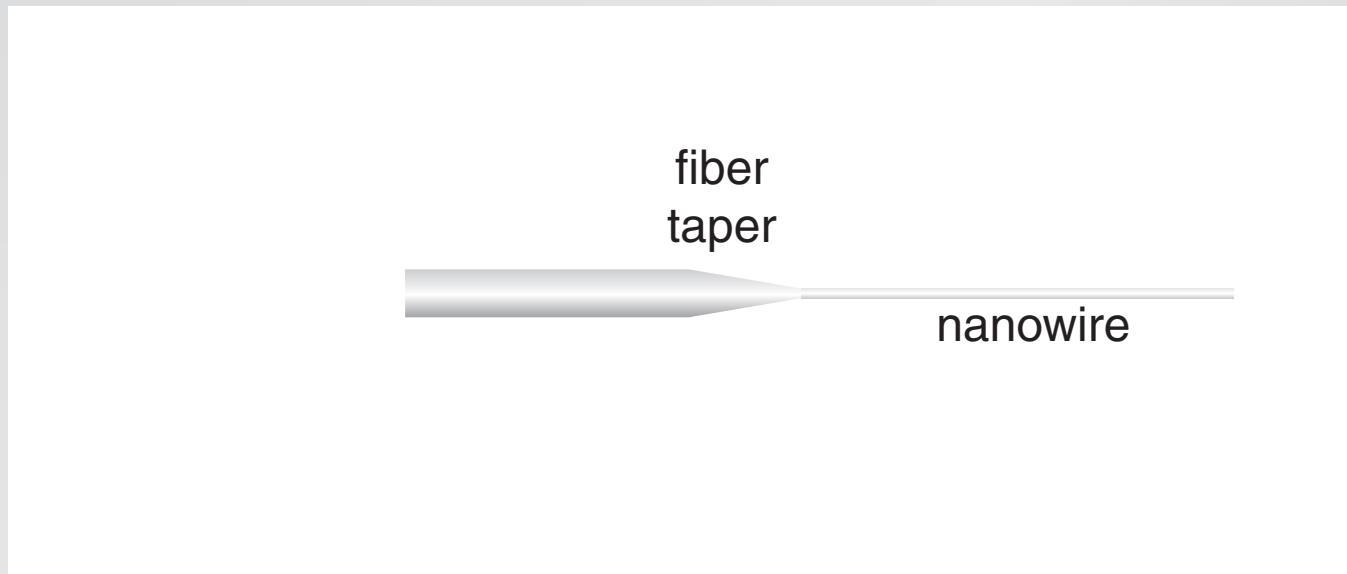

Manipulating light at the nanoscale

coupling light into nanowires

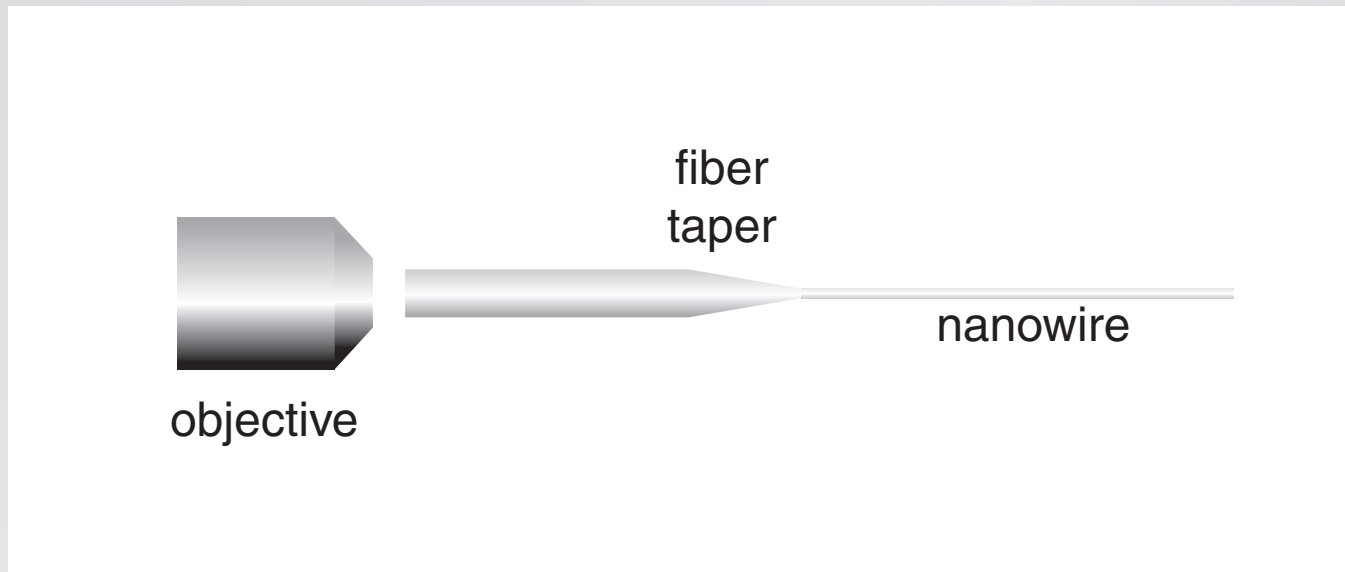

Manipulating light at the nanoscale

coupling light into nanowires

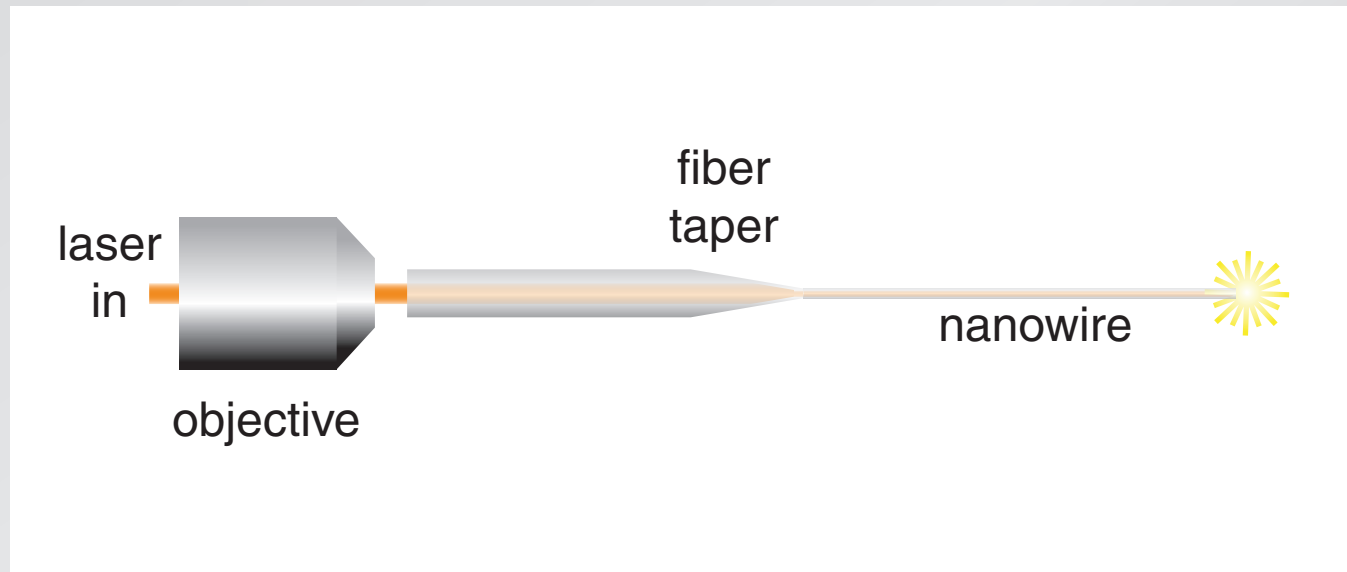

Manipulating light at the nanoscale

280-nm nanowire

A scanning electron microscope (SEM) image of a single, thin nanowire. The nanowire is a single, continuous line of material, appearing as a thin, dark horizontal line against a lighter background. The width of the nanowire is consistent with the 280-nm label.

360 nm

A scanning electron microscope (SEM) image of a single nanowire. The nanowire is a single, continuous line of material, appearing as a thin, dark horizontal line against a lighter background. The width of the nanowire is consistent with the 360 nm label.

450 nm

A scanning electron microscope (SEM) image of a single nanowire. The nanowire is a single, continuous line of material, appearing as a thin, dark horizontal line against a lighter background. The width of the nanowire is consistent with the 450 nm label.

Manipulating light at the nanoscale

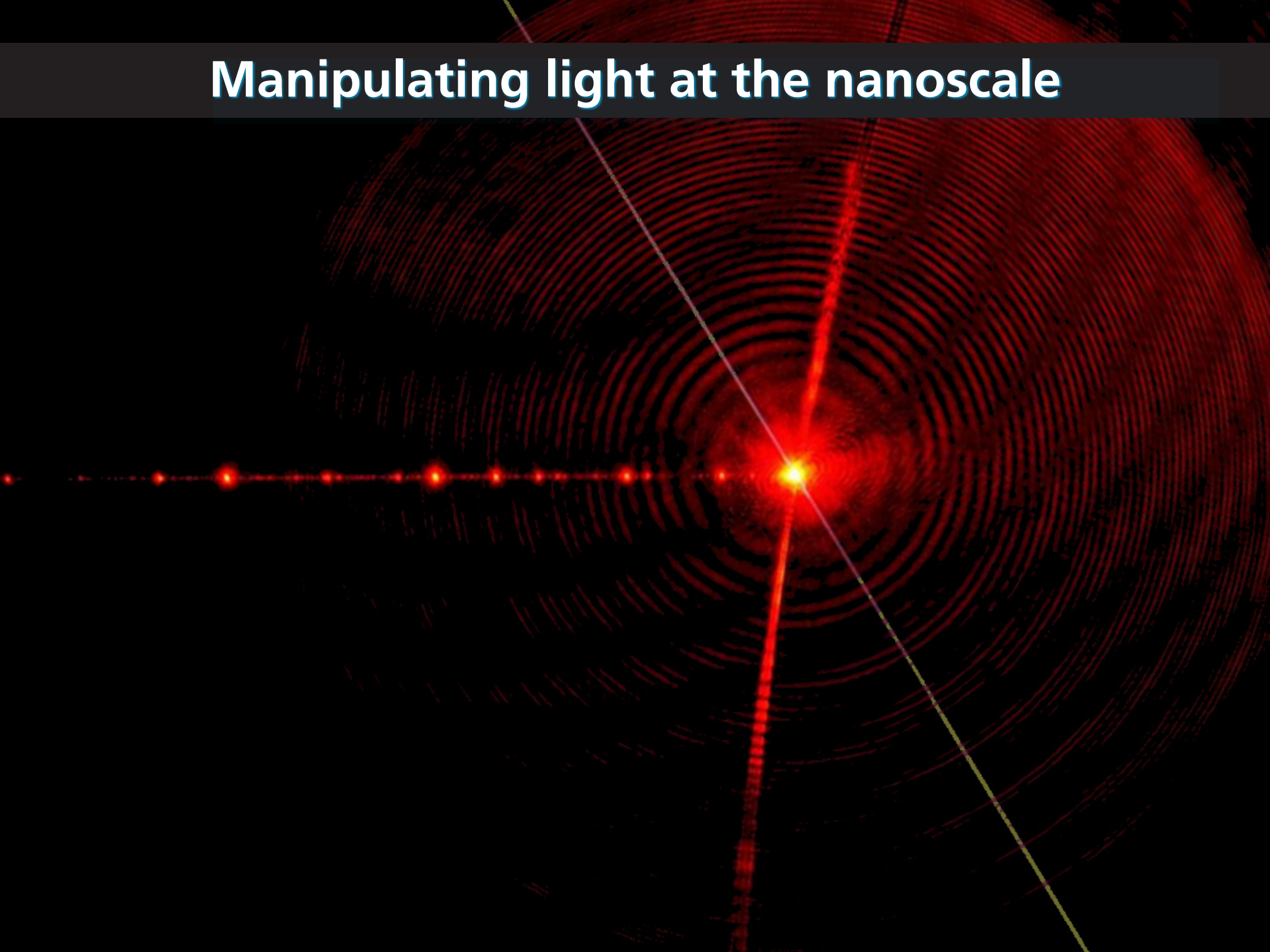

Manipulating light at the nanoscale

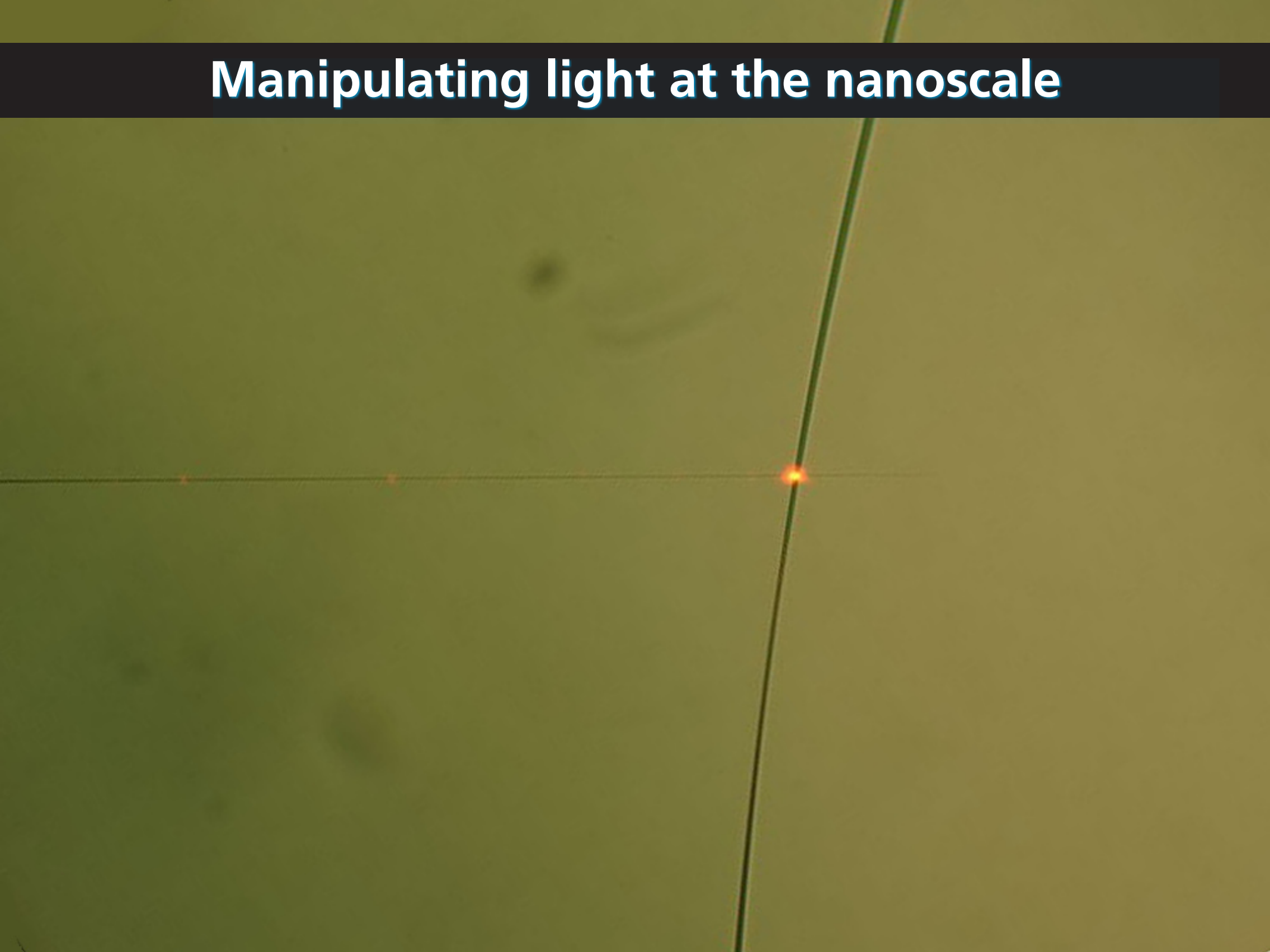

Manipulating light at the nanoscale

Poynting vector profile for 800-nm nanowire

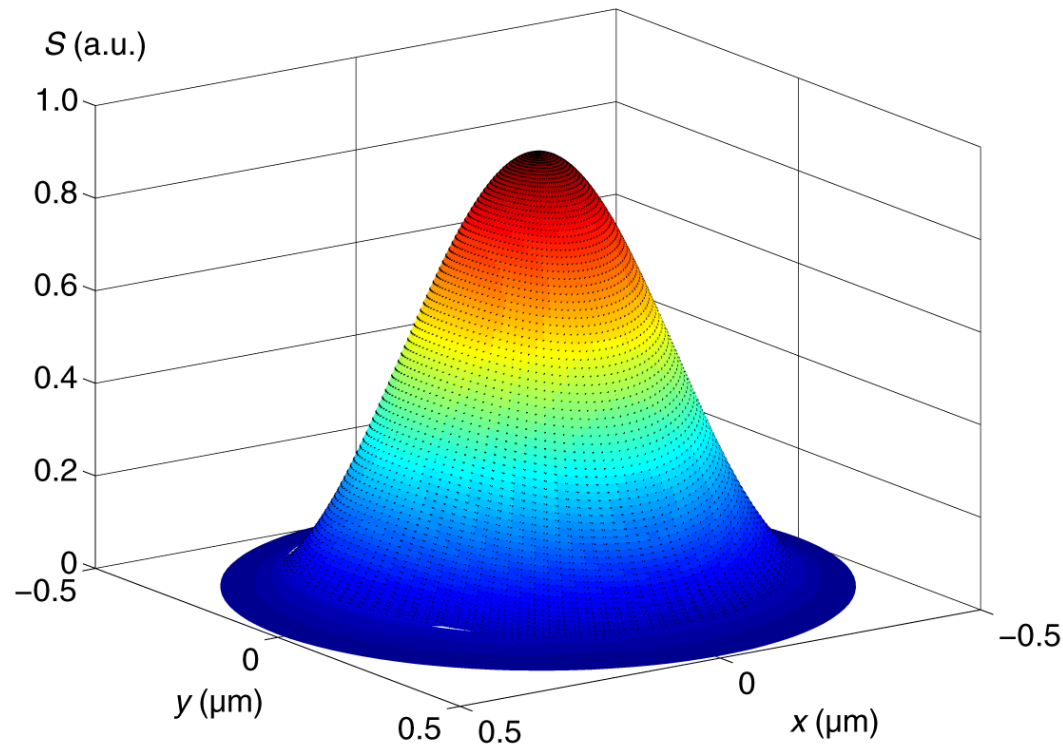

Manipulating light at the nanoscale

Poynting vector profile for 800-nm nanowire

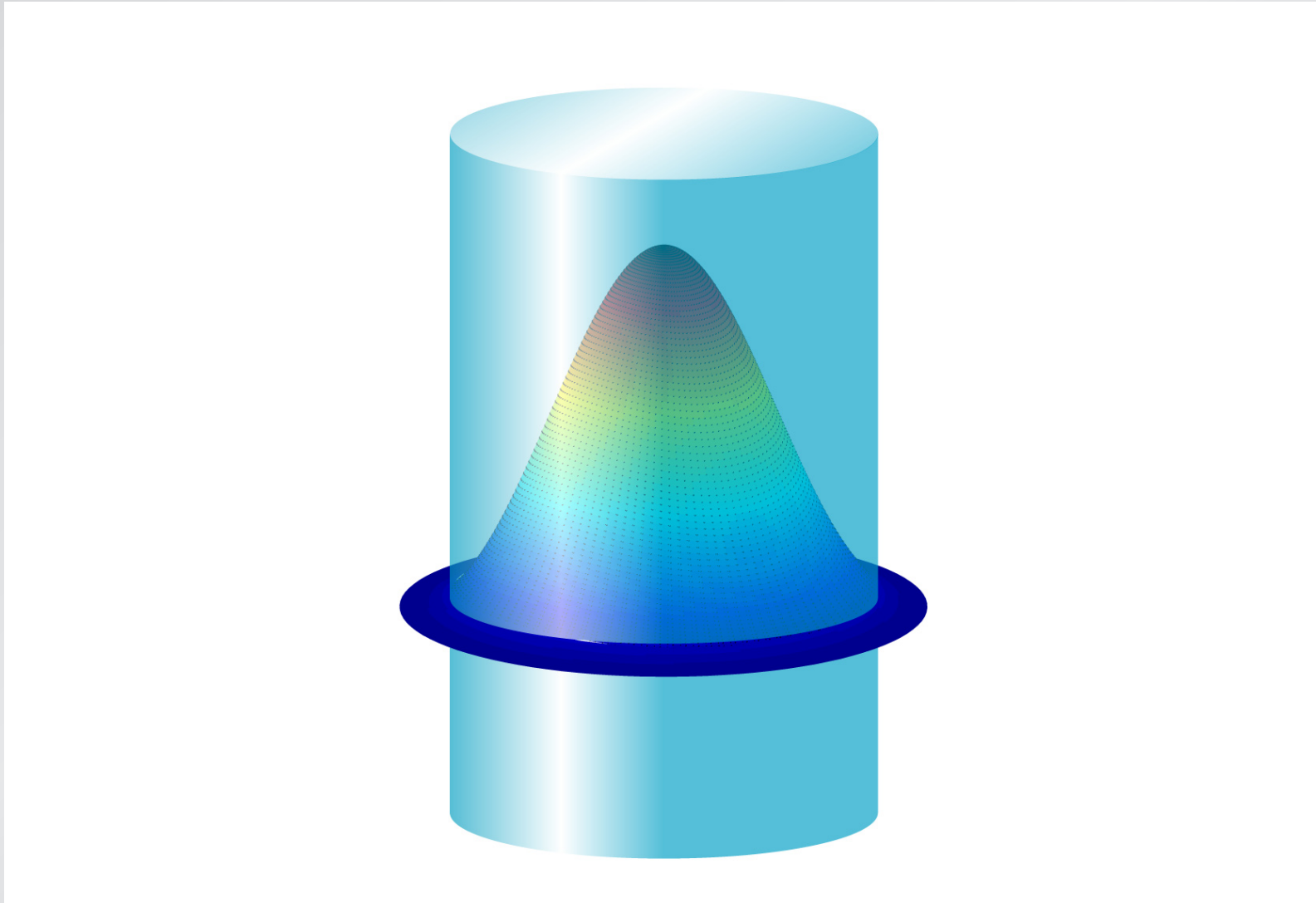

Manipulating light at the nanoscale

Poynting vector profile for 800-nm nanowire

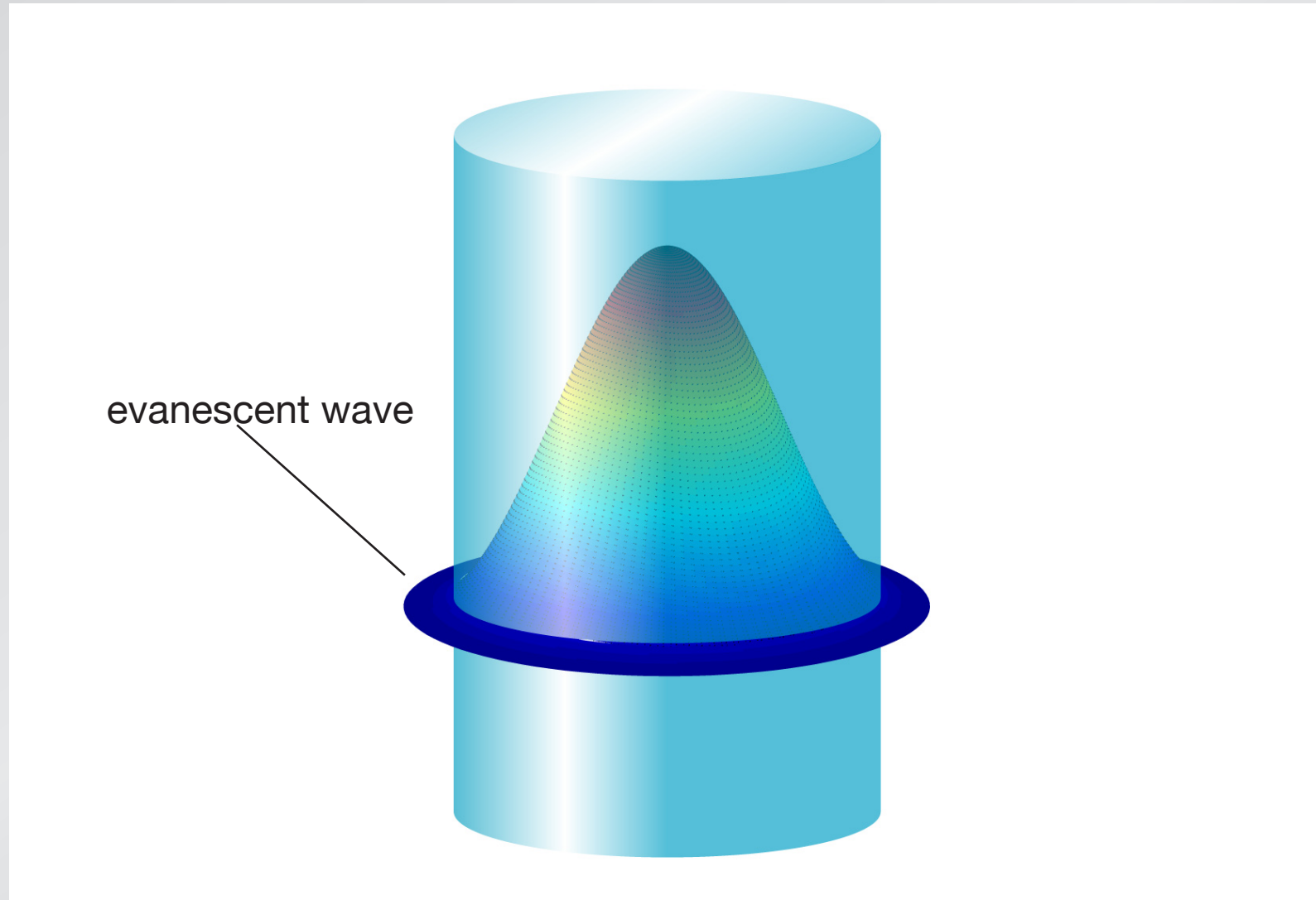

Manipulating light at the nanoscale

Poynting vector profile for 600-nm nanowire

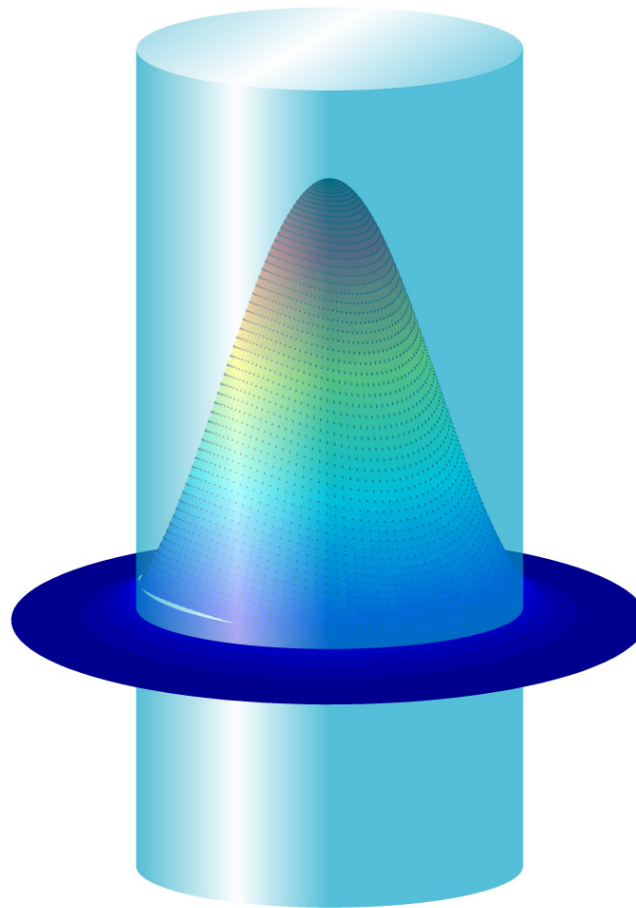

Manipulating light at the nanoscale

Poynting vector profile for 500-nm nanowire

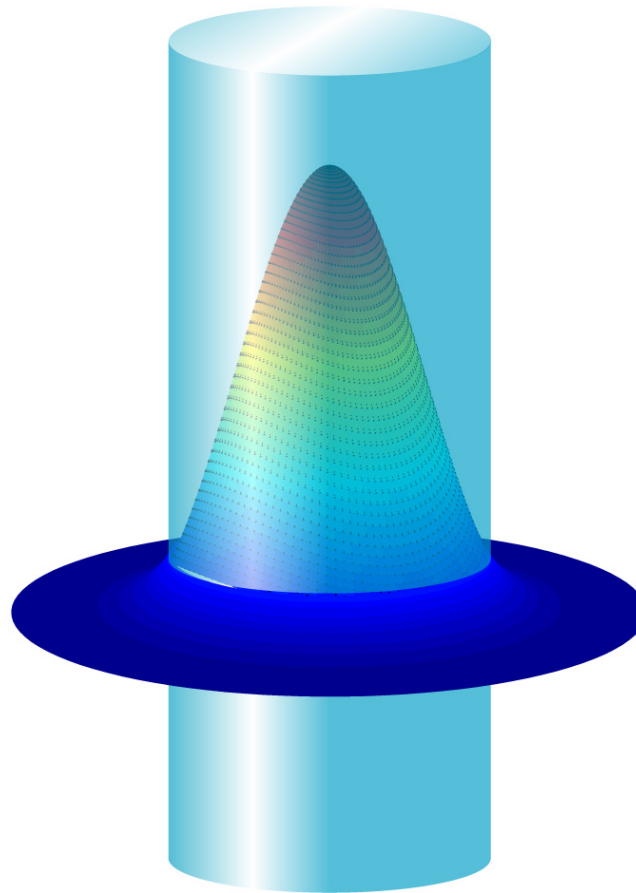

Manipulating light at the nanoscale

Poynting vector profile for 400-nm nanowire

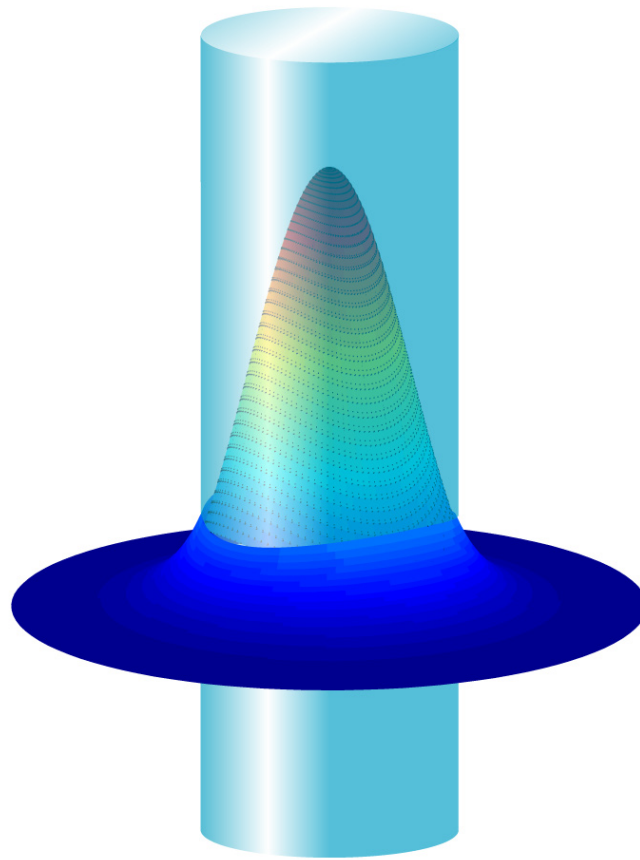

Manipulating light at the nanoscale

Poynting vector profile for 300-nm nanowire

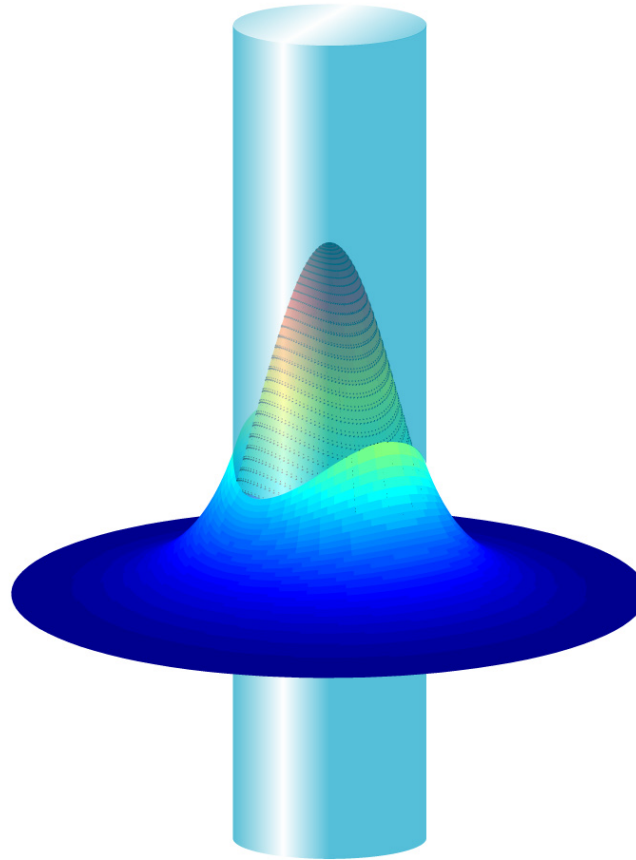

Manipulating light at the nanoscale

Poynting vector profile for 200-nm nanowire

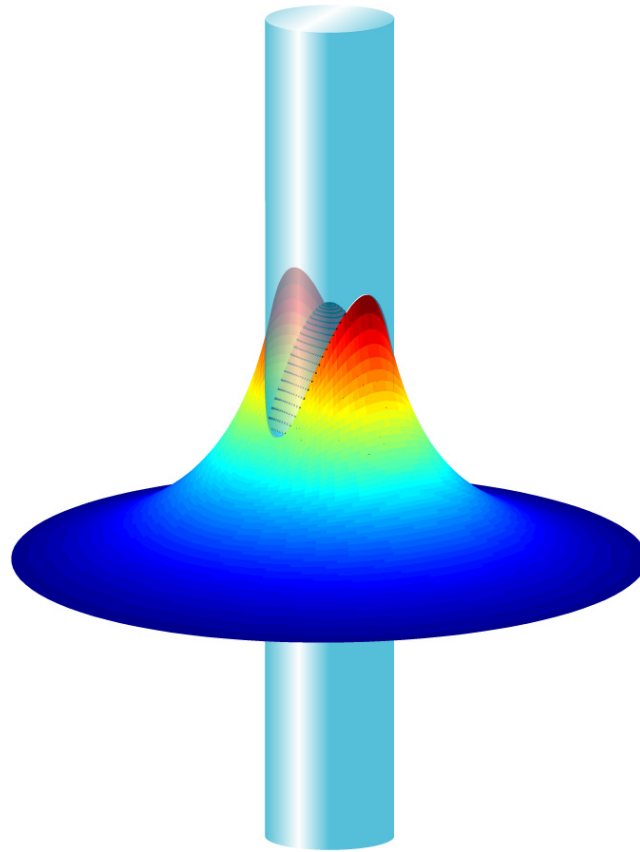

Manipulating light at the nanoscale

fraction of power carried in core

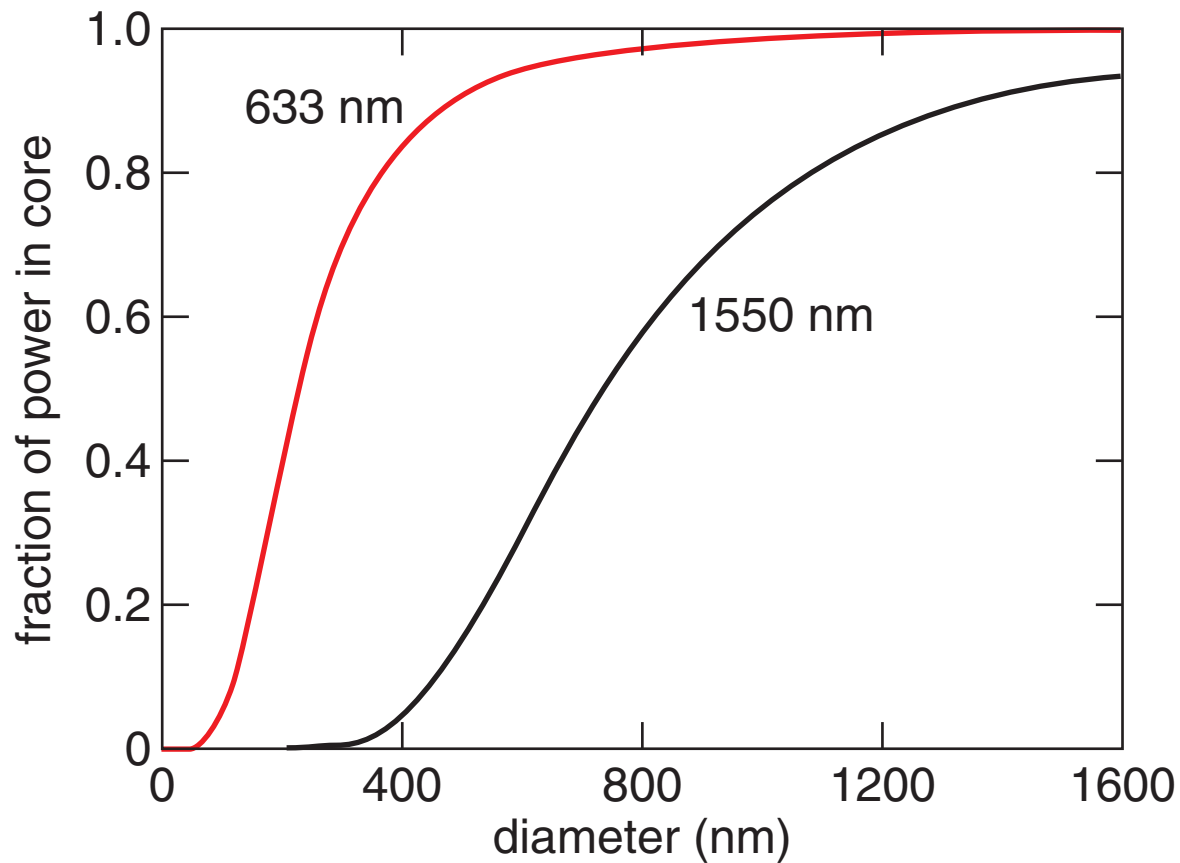

Manipulating light at the nanoscale

coupling light between nanowires

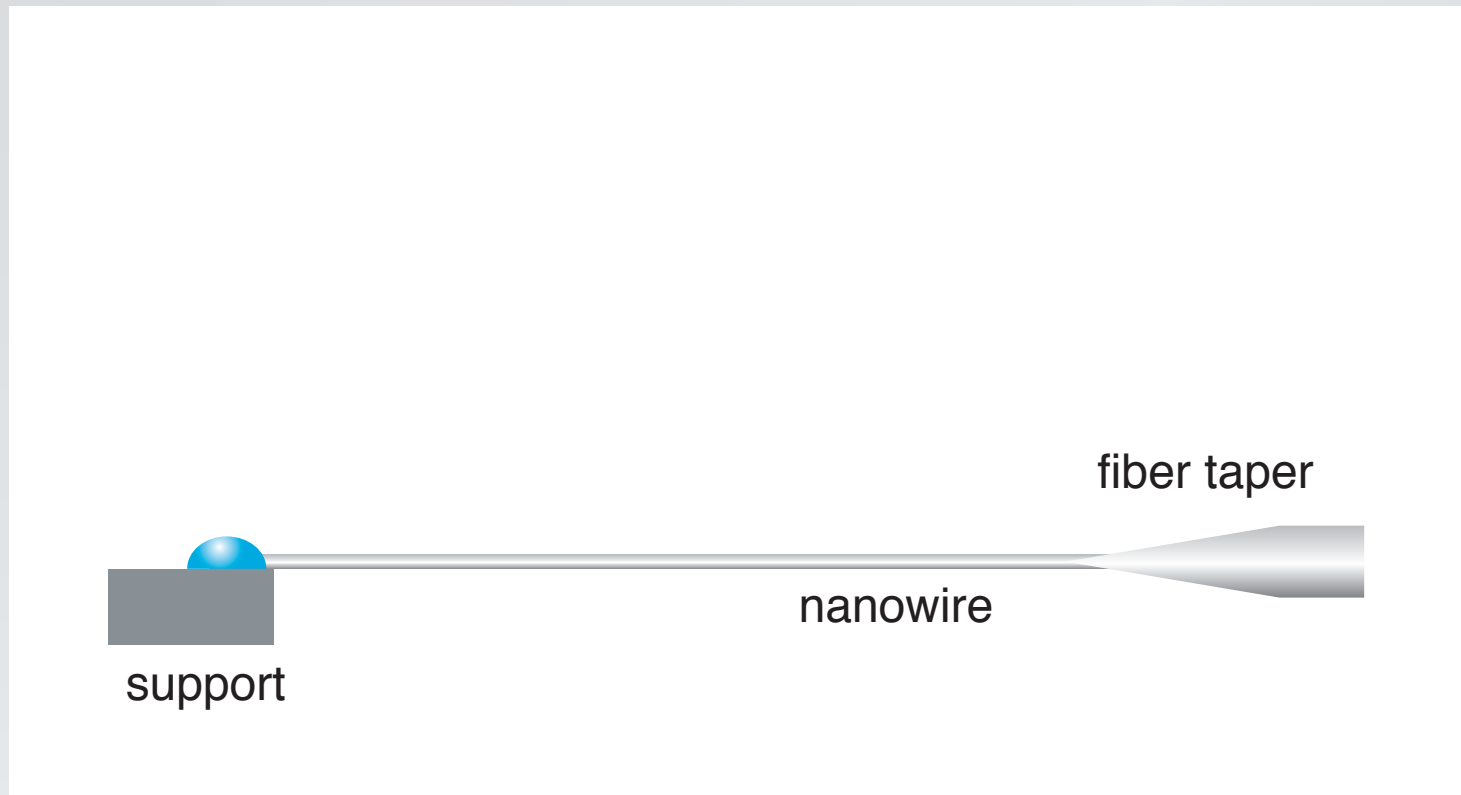

Manipulating light at the nanoscale

coupling light between nanowires

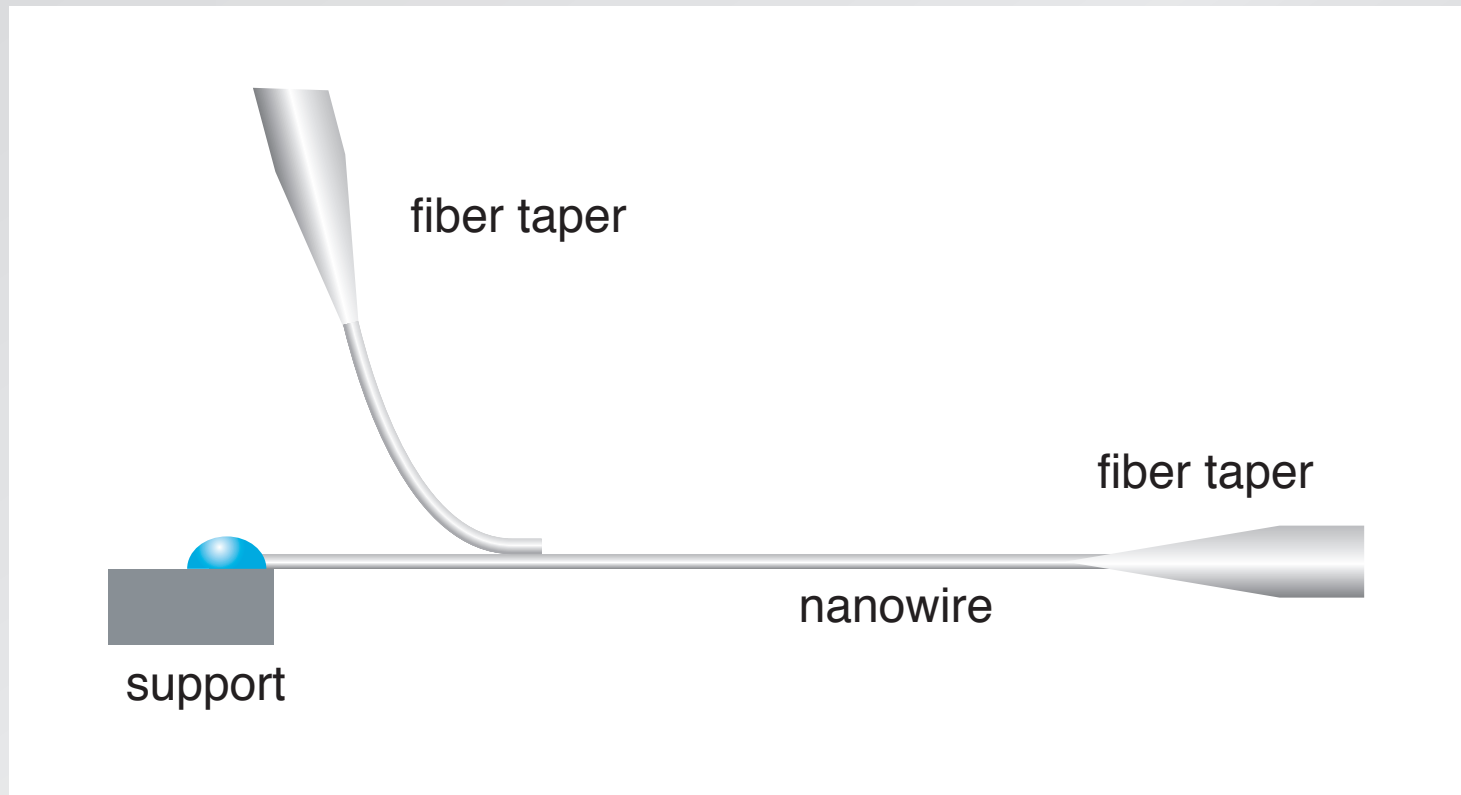

Manipulating light at the nanoscale

coupling light between nanowires

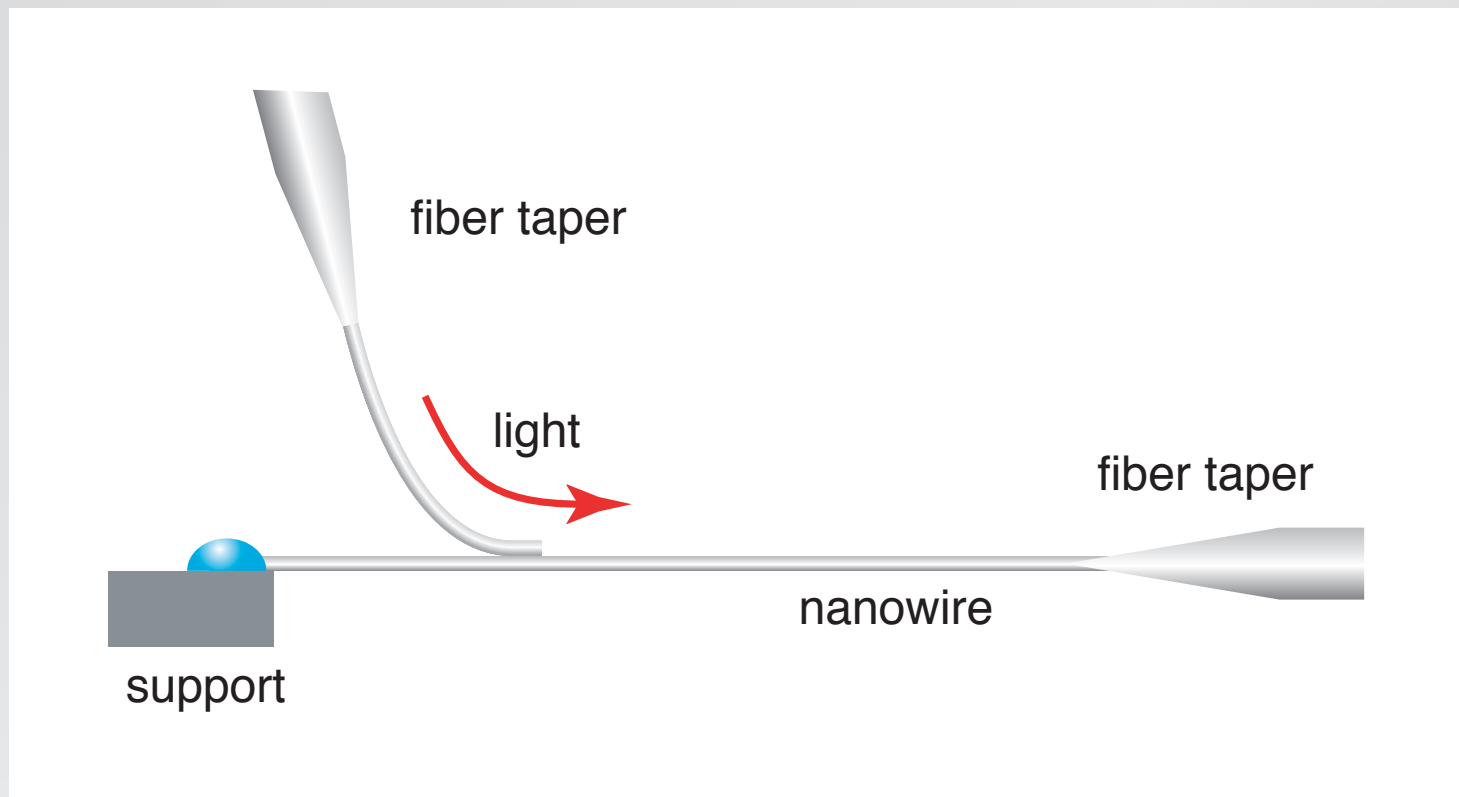

Manipulating light at the nanoscale

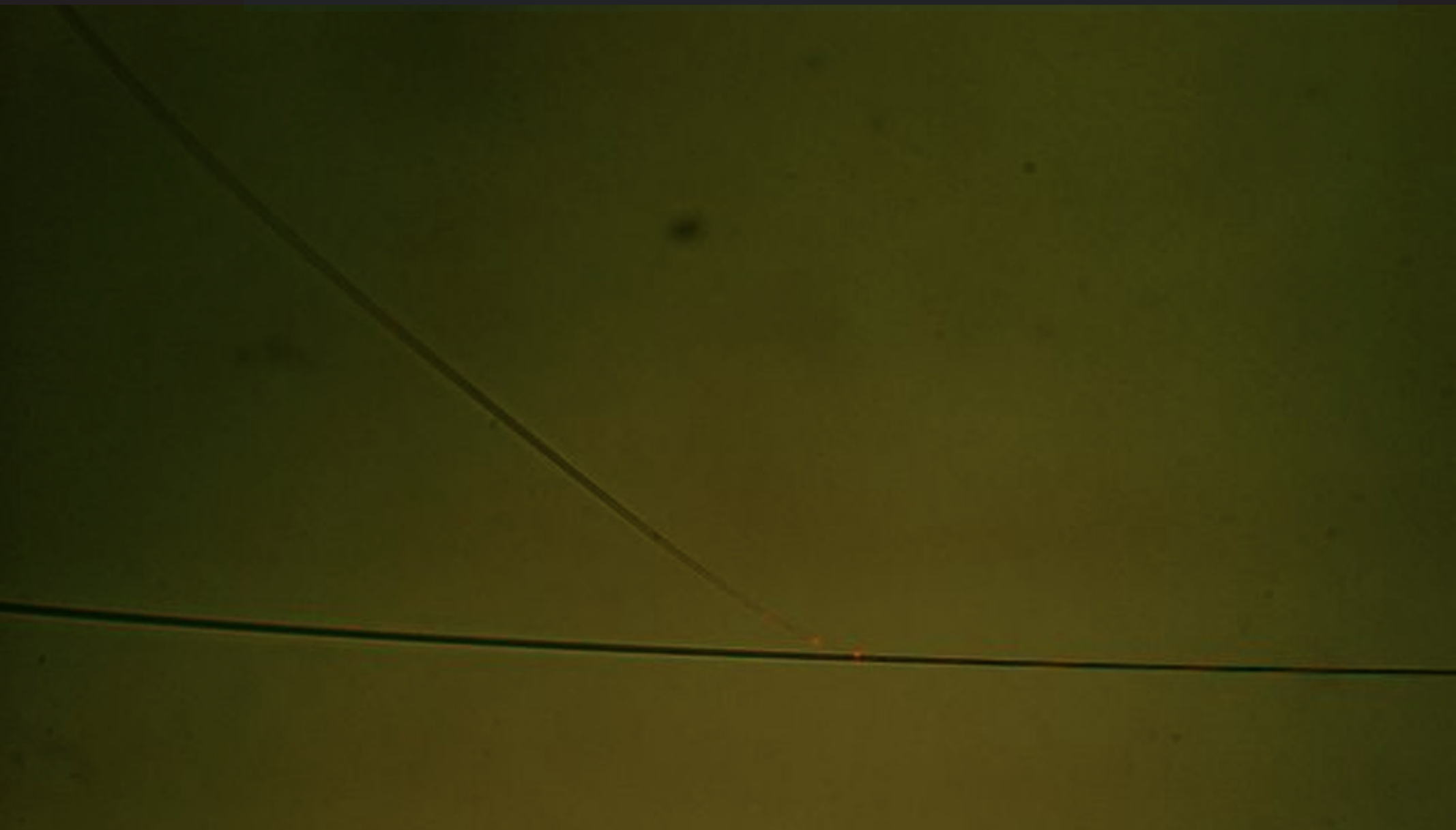

50 μm

Manipulating light at the nanoscale



50 μm

Manipulating light at the nanoscale

intensity distribution

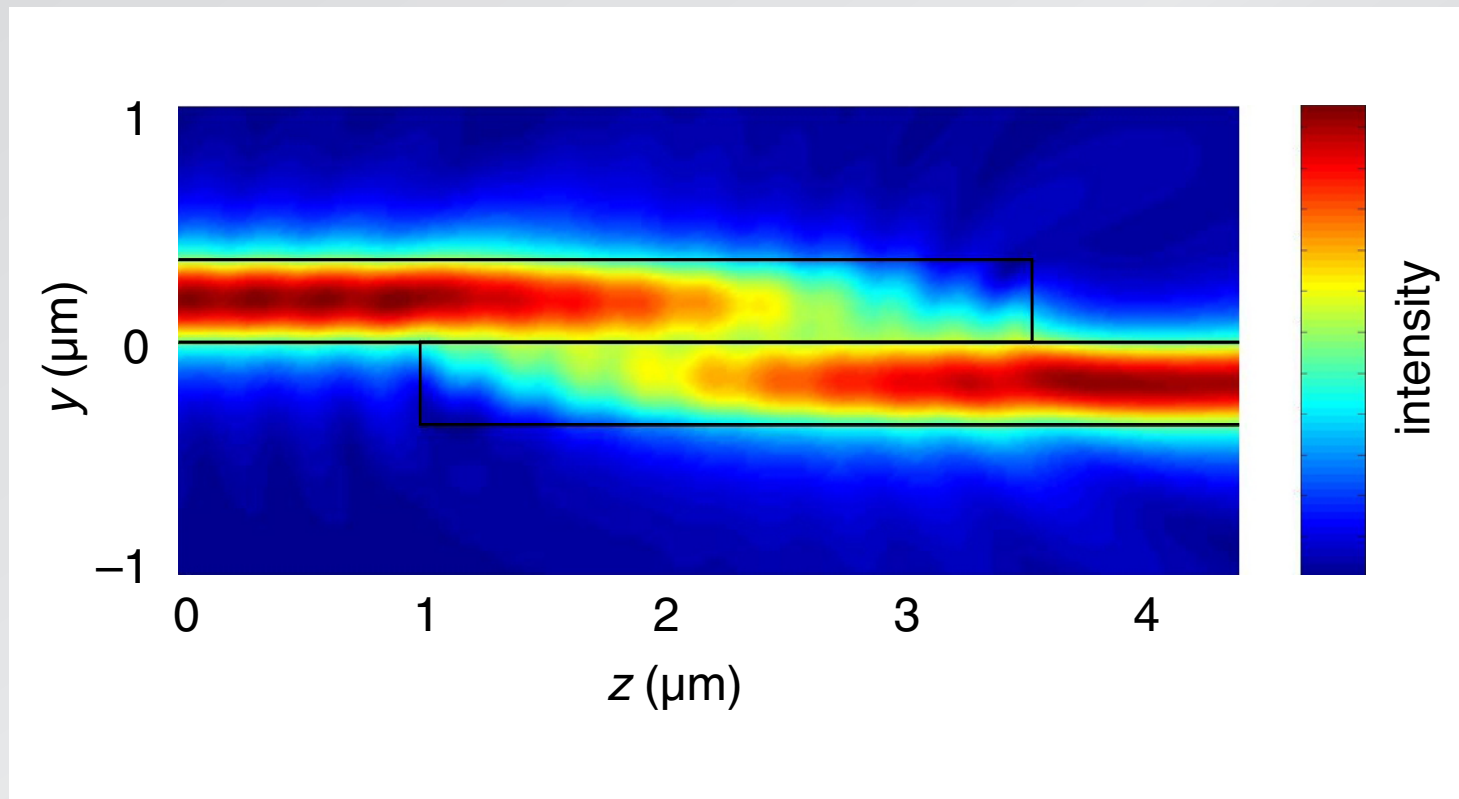

Manipulating light at the nanoscale

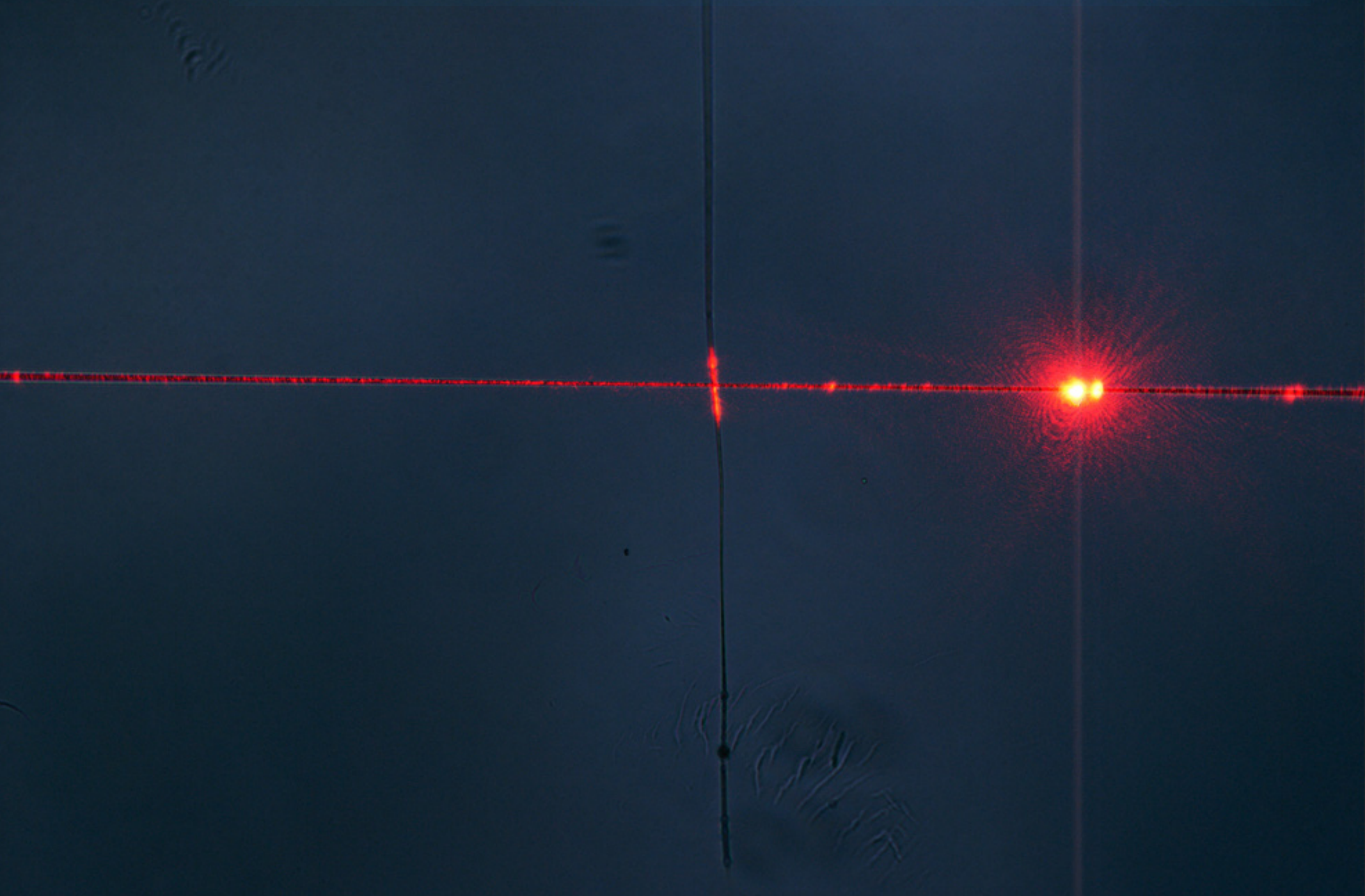

Manipulating light at the nanoscale

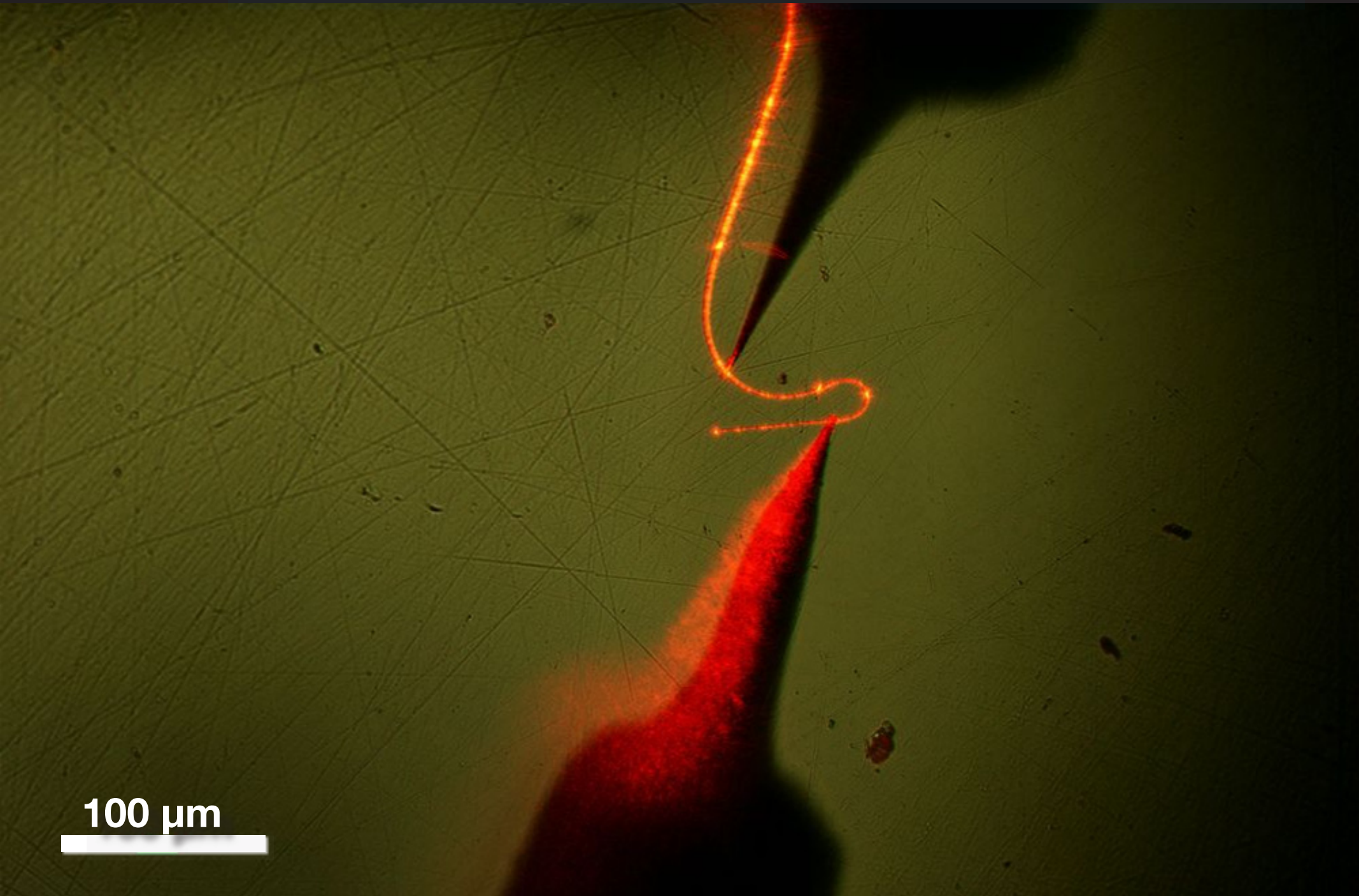

100 μm



Manipulating light at the nanoscale

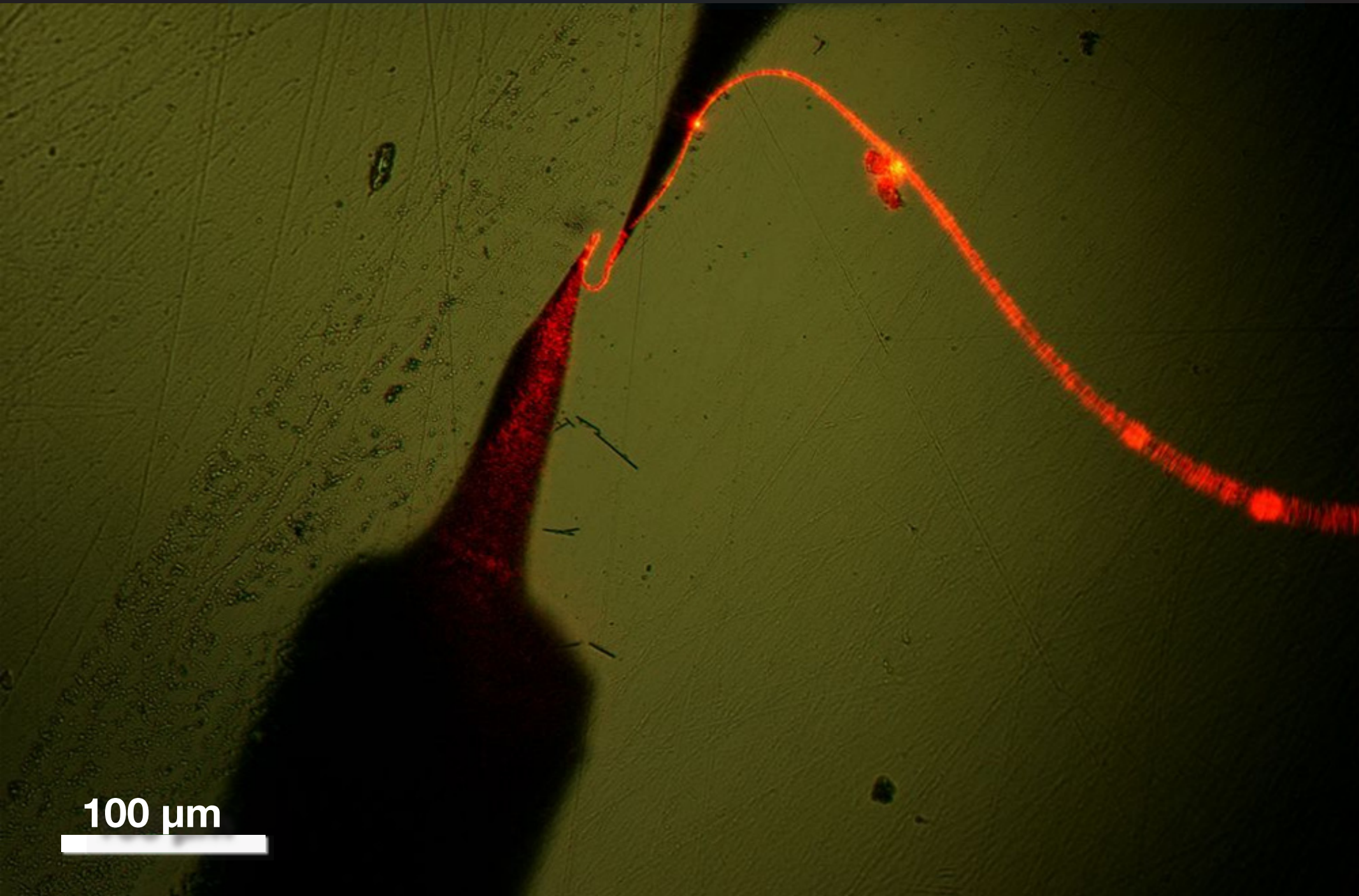

100 μm

Manipulating light at the nanoscale

minimum bending
radius: $5.6 \mu\text{m}$

100 μm

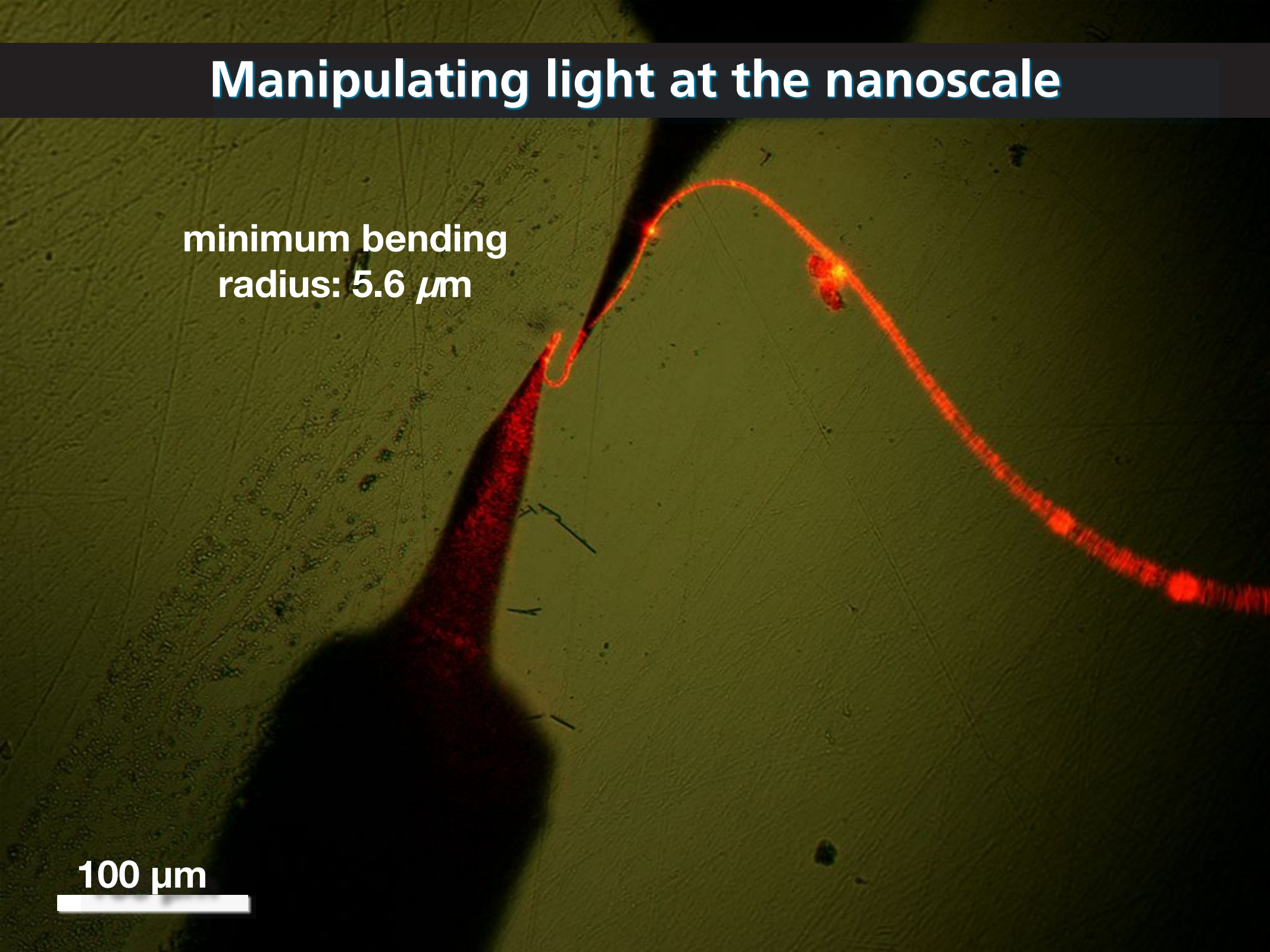
A micrograph showing a fiber optic cable with a sharp bend. The fiber is illuminated from the left, creating a bright red glow. The bend is very tight, and the light is visible as a thin, curved line. The background is a dark, textured surface. A scale bar is located in the bottom left corner, and text is overlaid on the image.

Manipulating light at the nanoscale

virtually no loss through 5 μm corner!

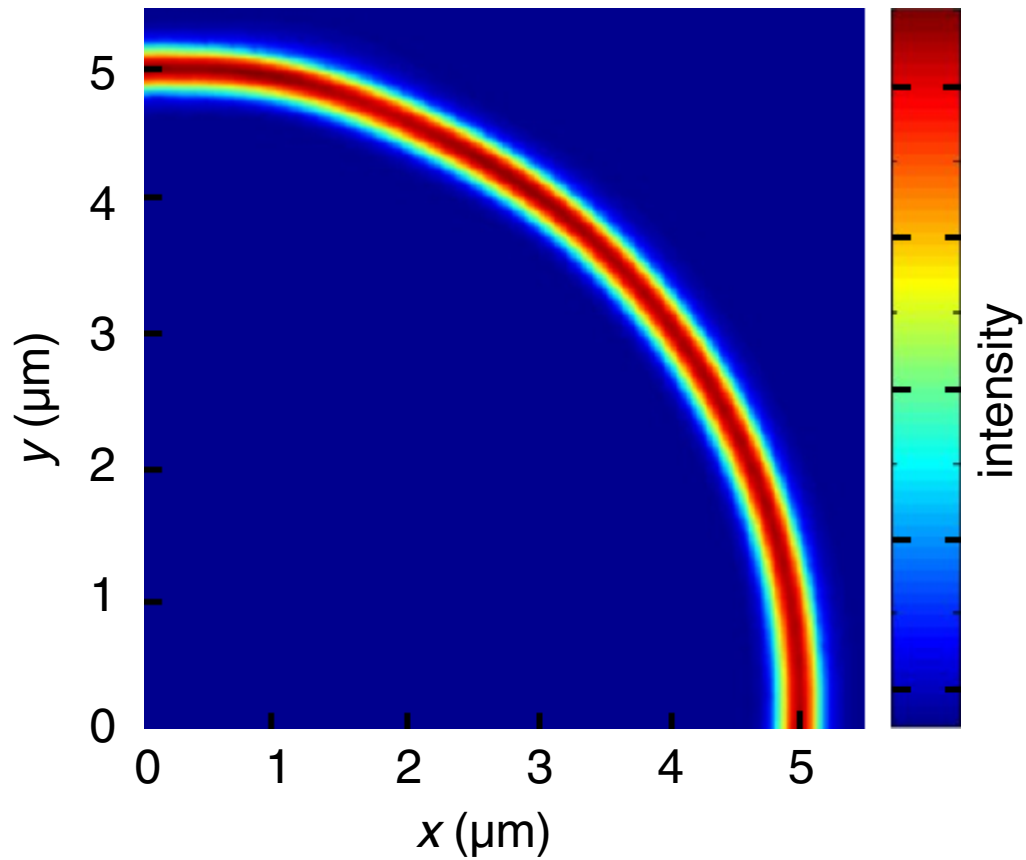

Manipulating light at the nanoscale

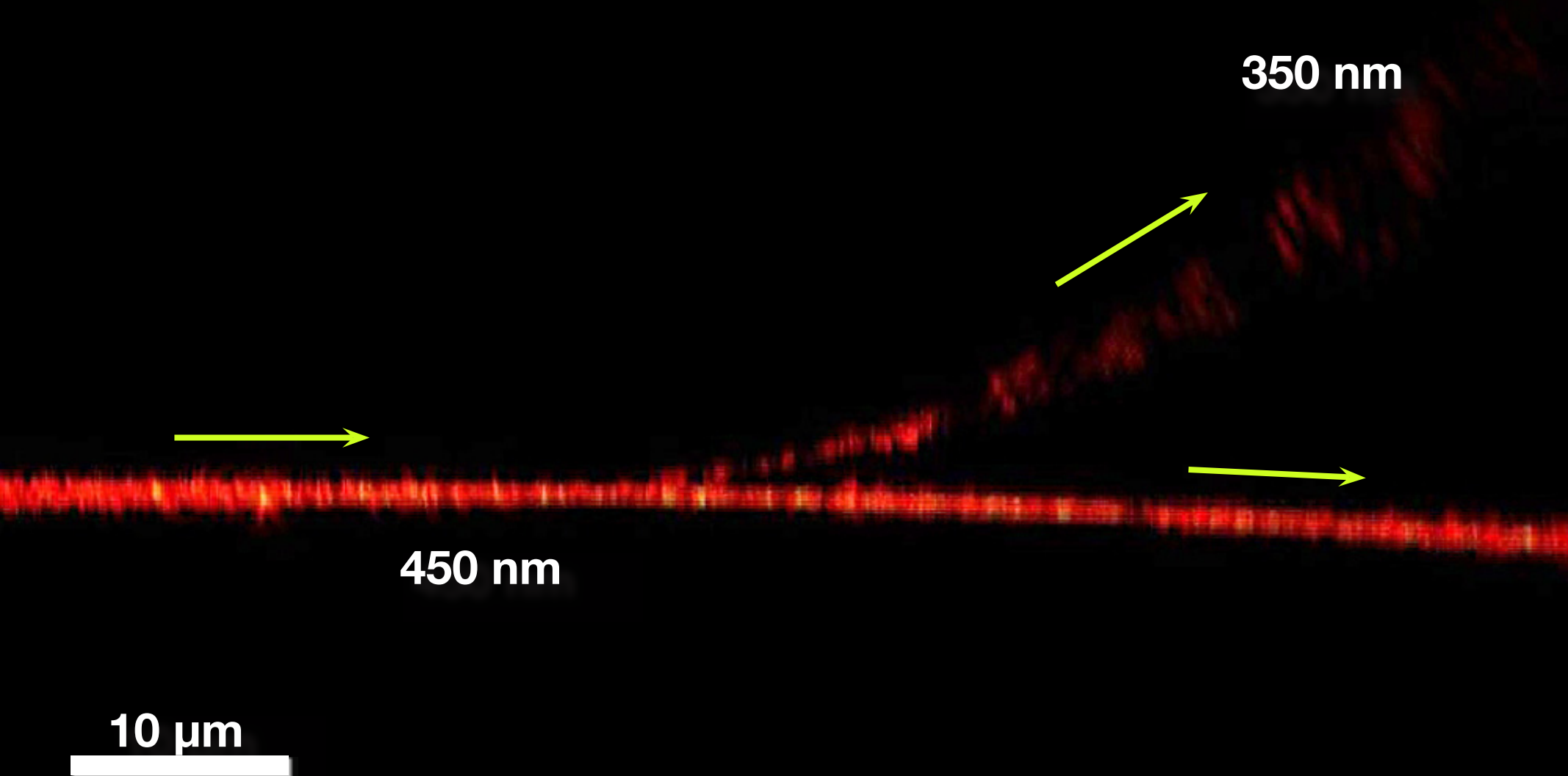

Manipulating light at the nanoscale



Manipulating light at the nanoscale

Aerogel

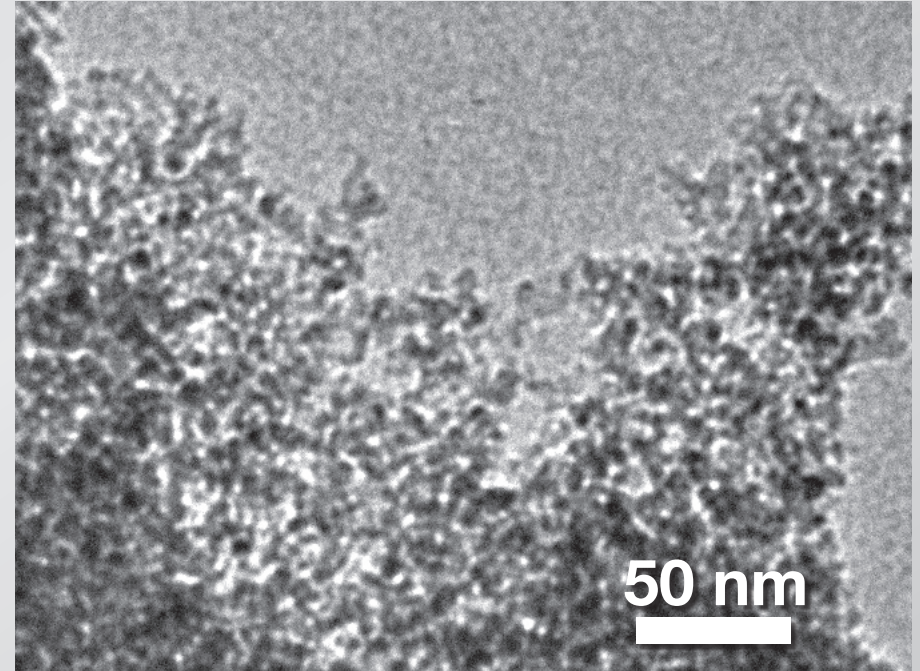
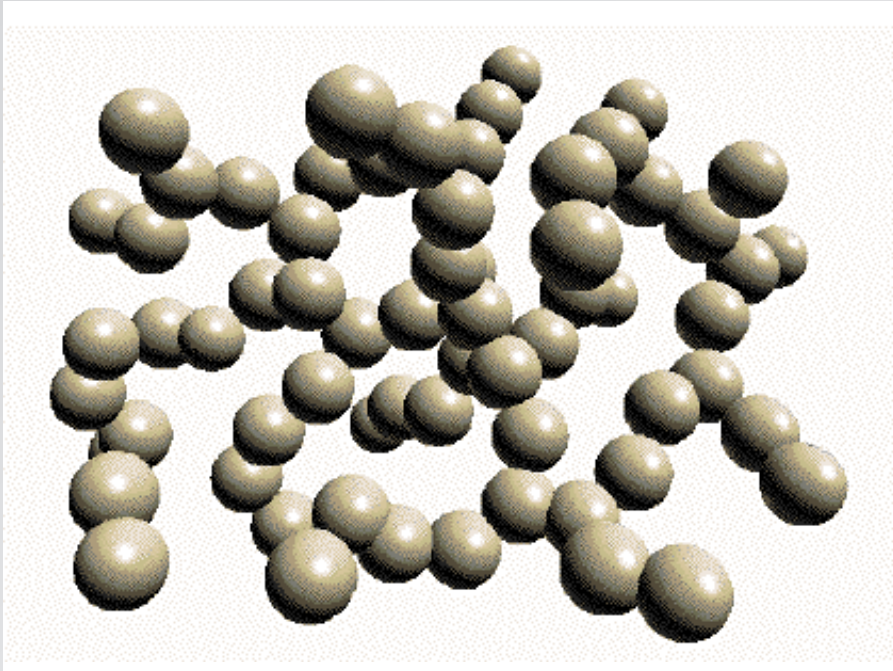

density: 1.9 kg/m^3

index of refraction: 1.03–1.08

Manipulating light at the nanoscale

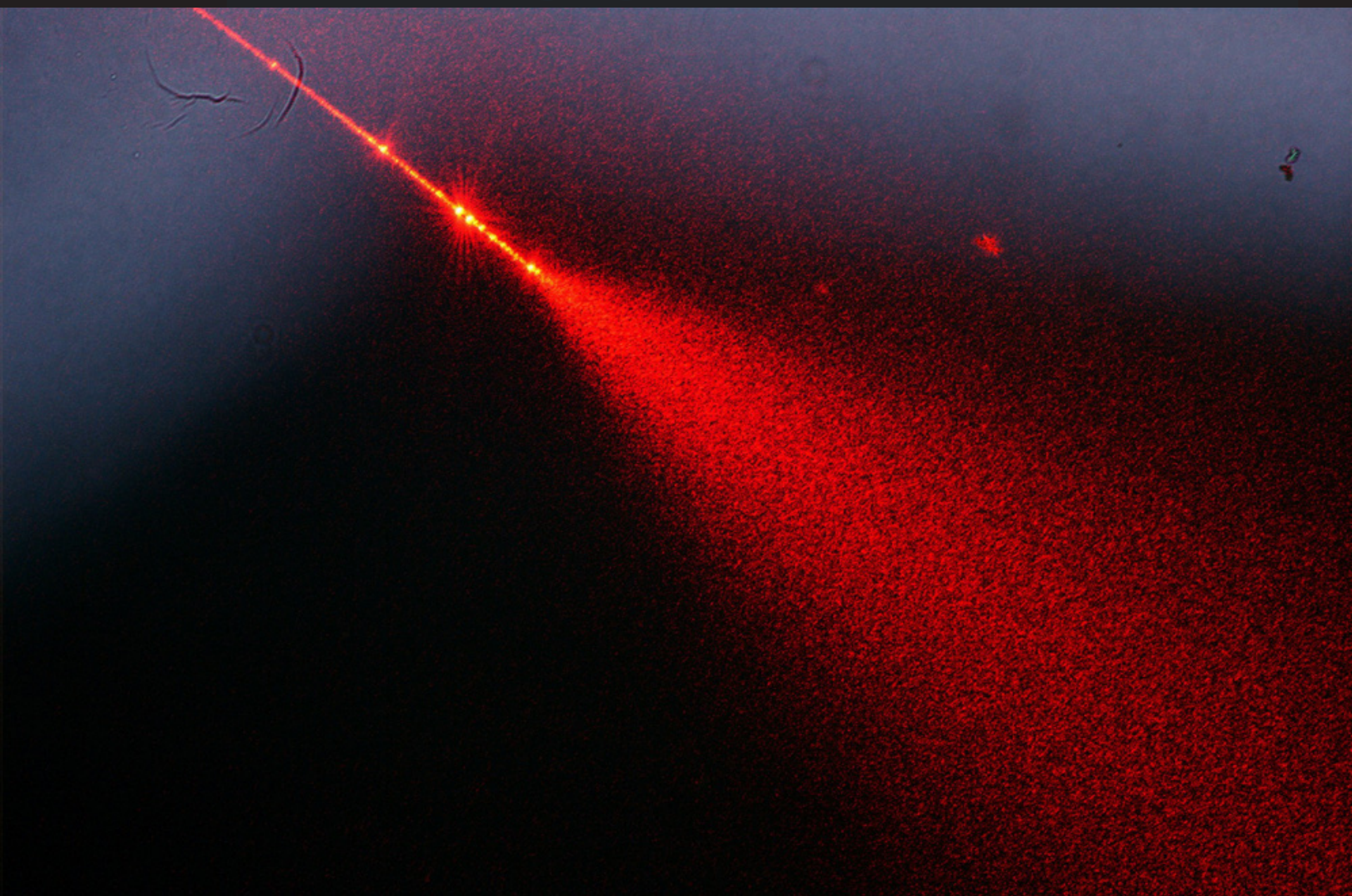

Manipulating light at the nanoscale

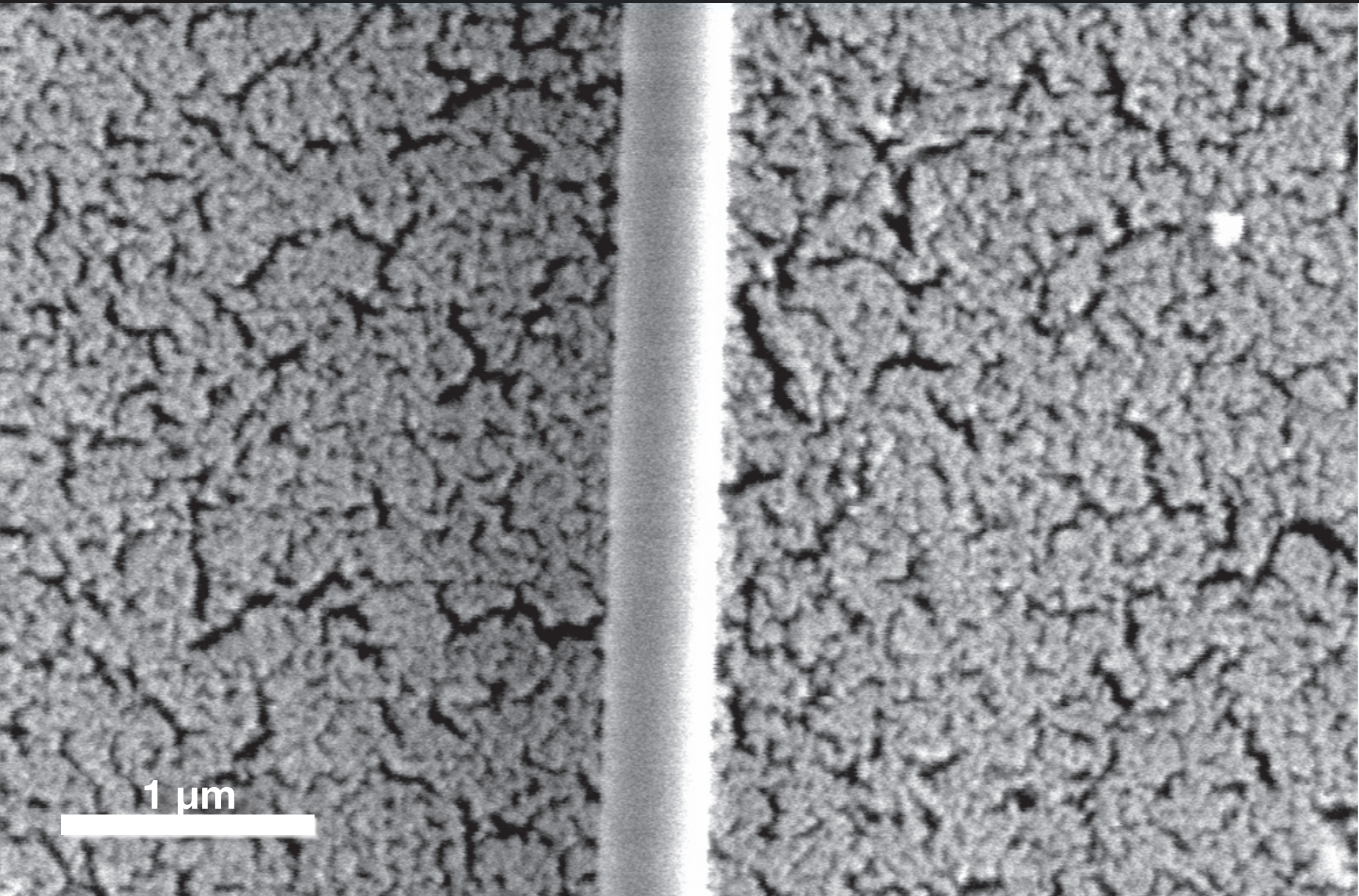

1 μm

Manipulating light at the nanoscale

530 nm

50 μm

A micrograph showing a microfluidic device. A red light path is visible, forming a loop and then extending horizontally. The device is composed of several parallel channels. A scale bar in the bottom left indicates 50 micrometers. The text '530 nm' is positioned above the red path, and '50 μm' is next to the scale bar.

Manipulating light at the nanoscale

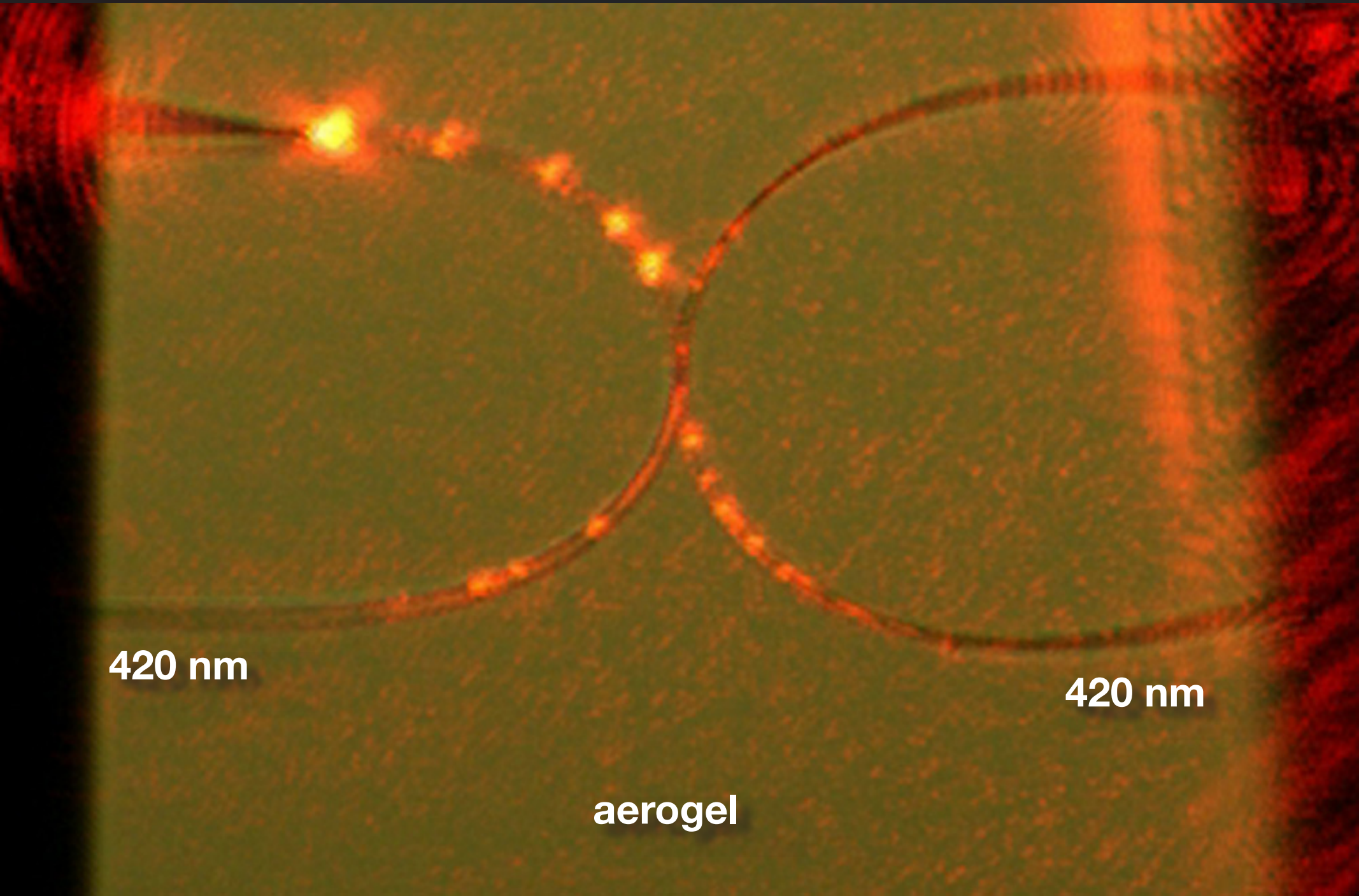

420 nm

420 nm

aerogel

Manipulating light at the nanoscale

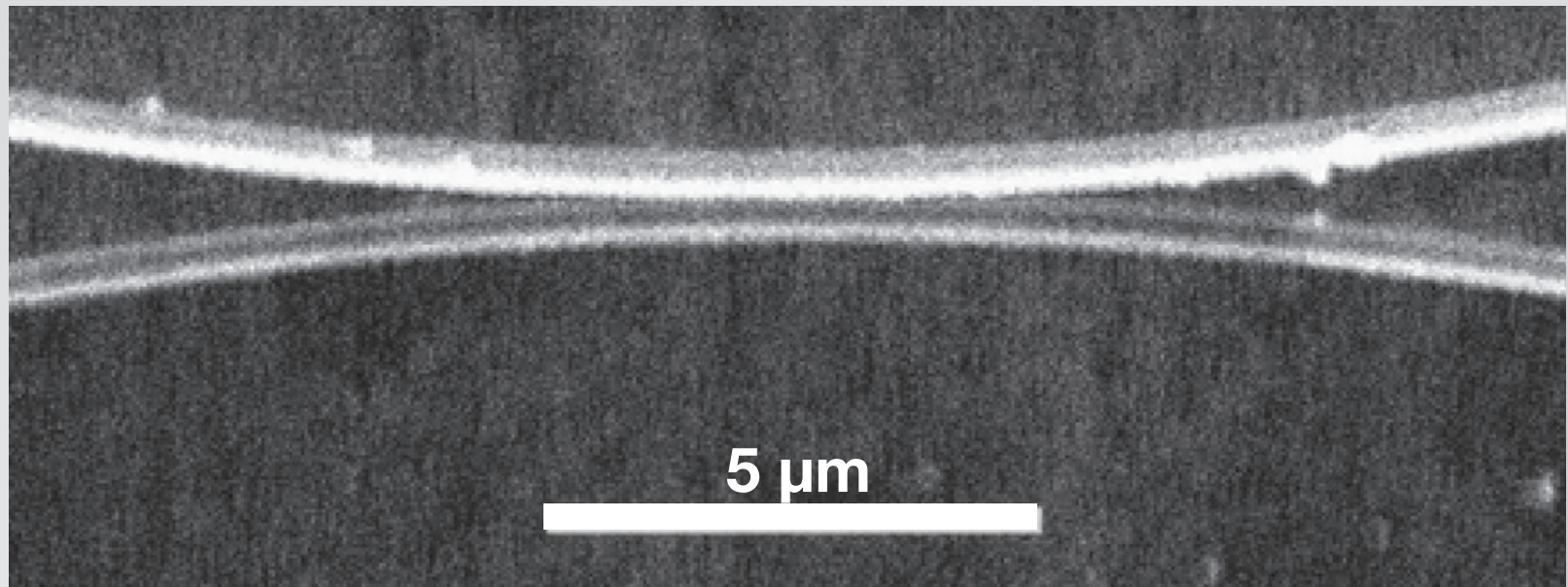

Manipulating light at the nanoscale

in



out



out



Manipulating light at the nanoscale

use tapered fibers to couple light to nanoscale objects

Manipulating light at the nanoscale

ZnO: non-toxic, wide bandgap semiconductor

A petri dish containing a white, powdery substance, likely ZnO nanoparticles, used for light manipulation at the nanoscale.

Manipulating light at the nanoscale

vapor transport grown ZnO nanowires

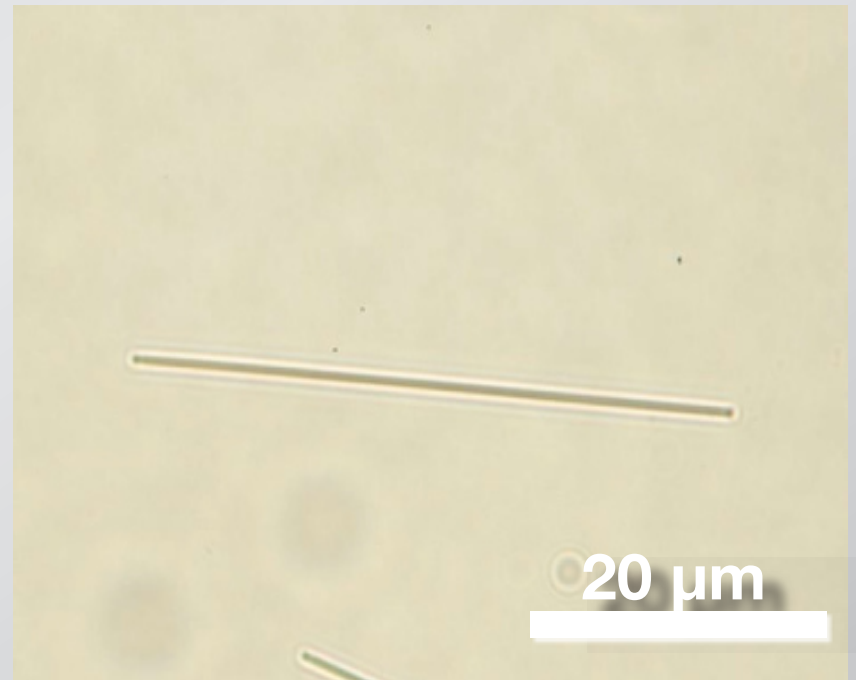
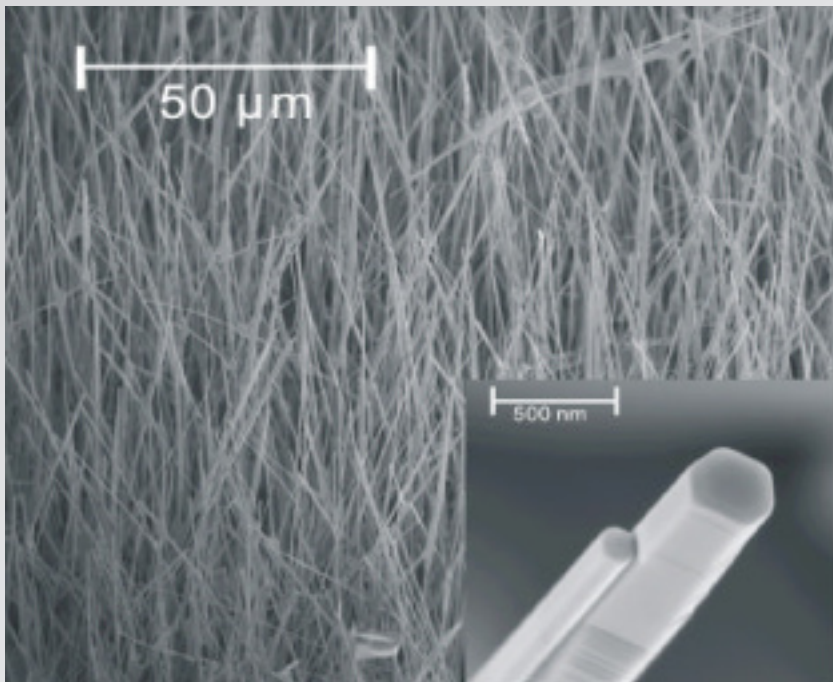

80–400 nm diameter, up to 80 μm long

Manipulating light at the nanoscale

best of both worlds

ZnO

silica

bottom-up

top-down

semiconductor

glass

active photonic devices

passive waveguides

electrical operation

link to macroworld

Manipulating light at the nanoscale

coupling to ZnO nanowires

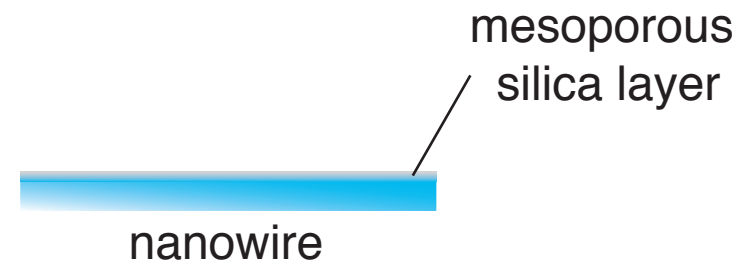

Manipulating light at the nanoscale

coupling to ZnO nanowires

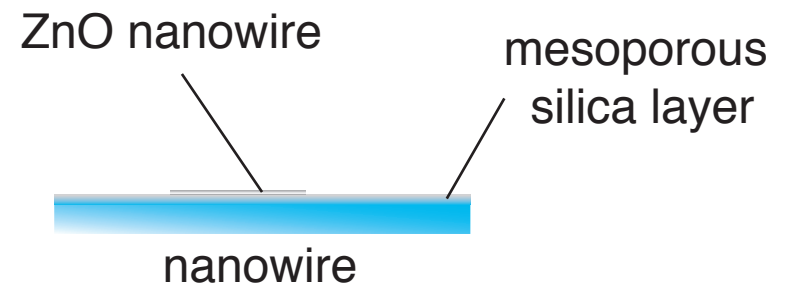

Manipulating light at the nanoscale

coupling to ZnO nanowires

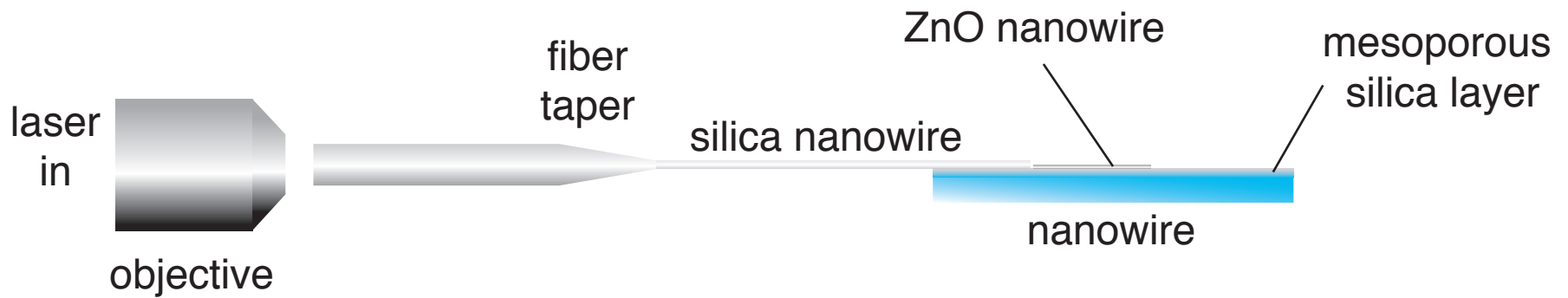

Manipulating light at the nanoscale

coupling to ZnO nanowires

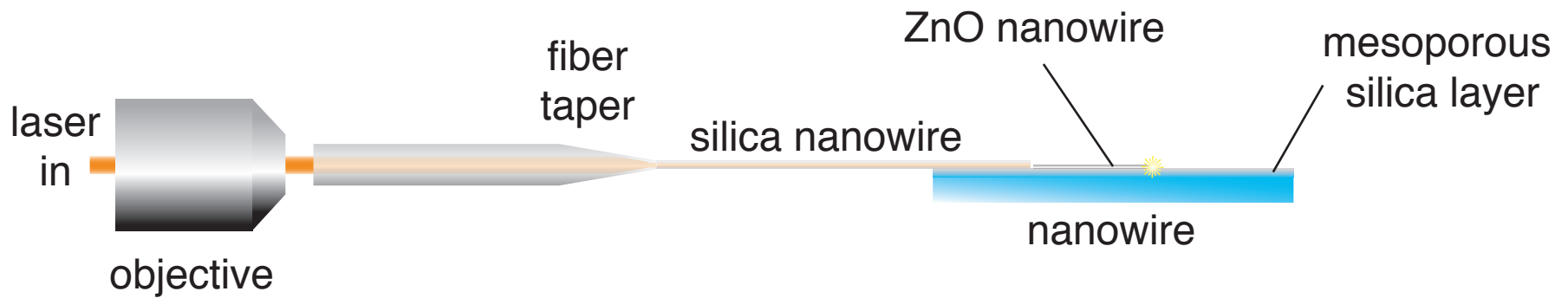

Manipulating light at the nanoscale

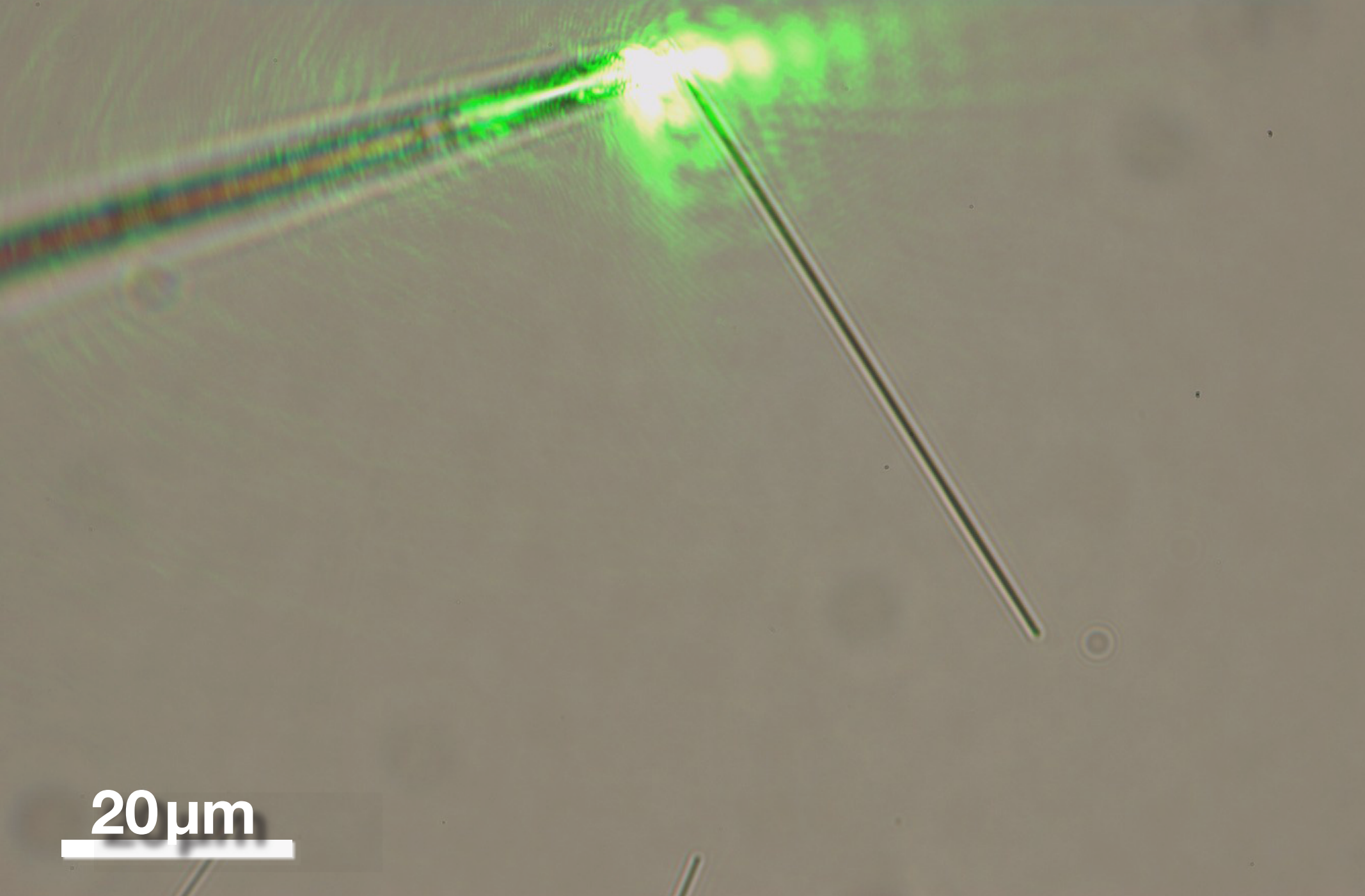

20 μm

Manipulating light at the nanoscale

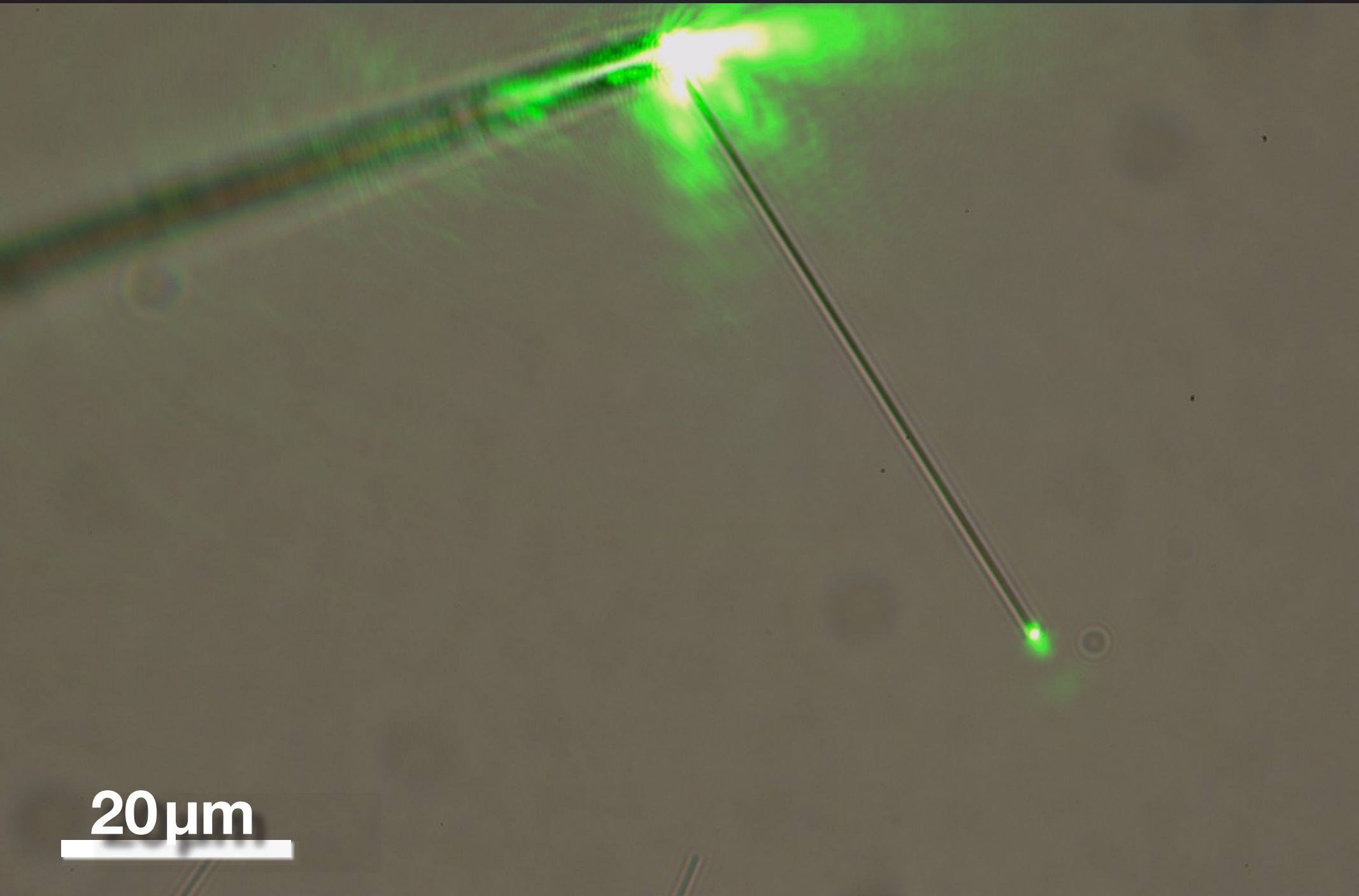

20 μm

Manipulating light at the nanoscale

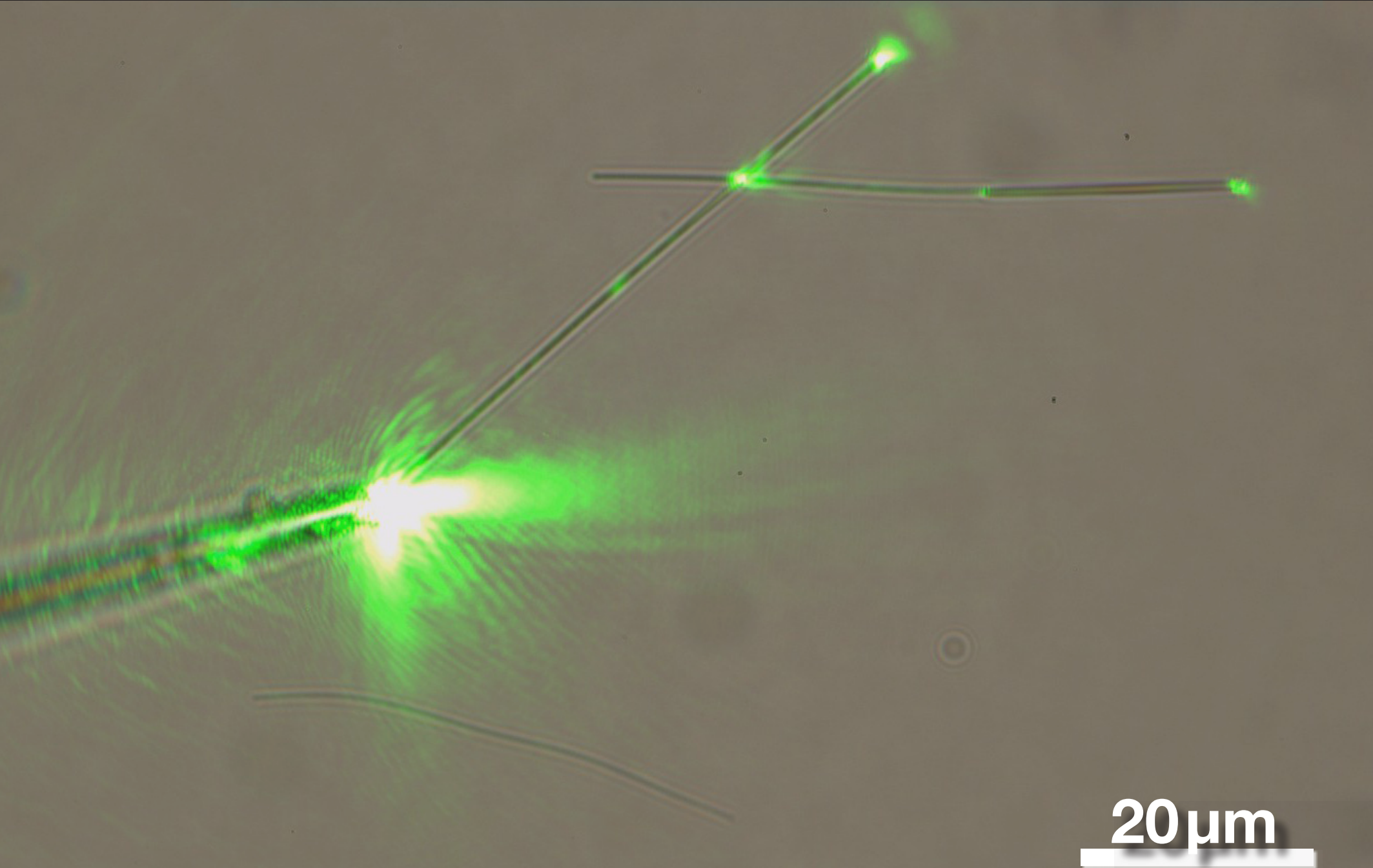

Manipulating light at the nanoscale

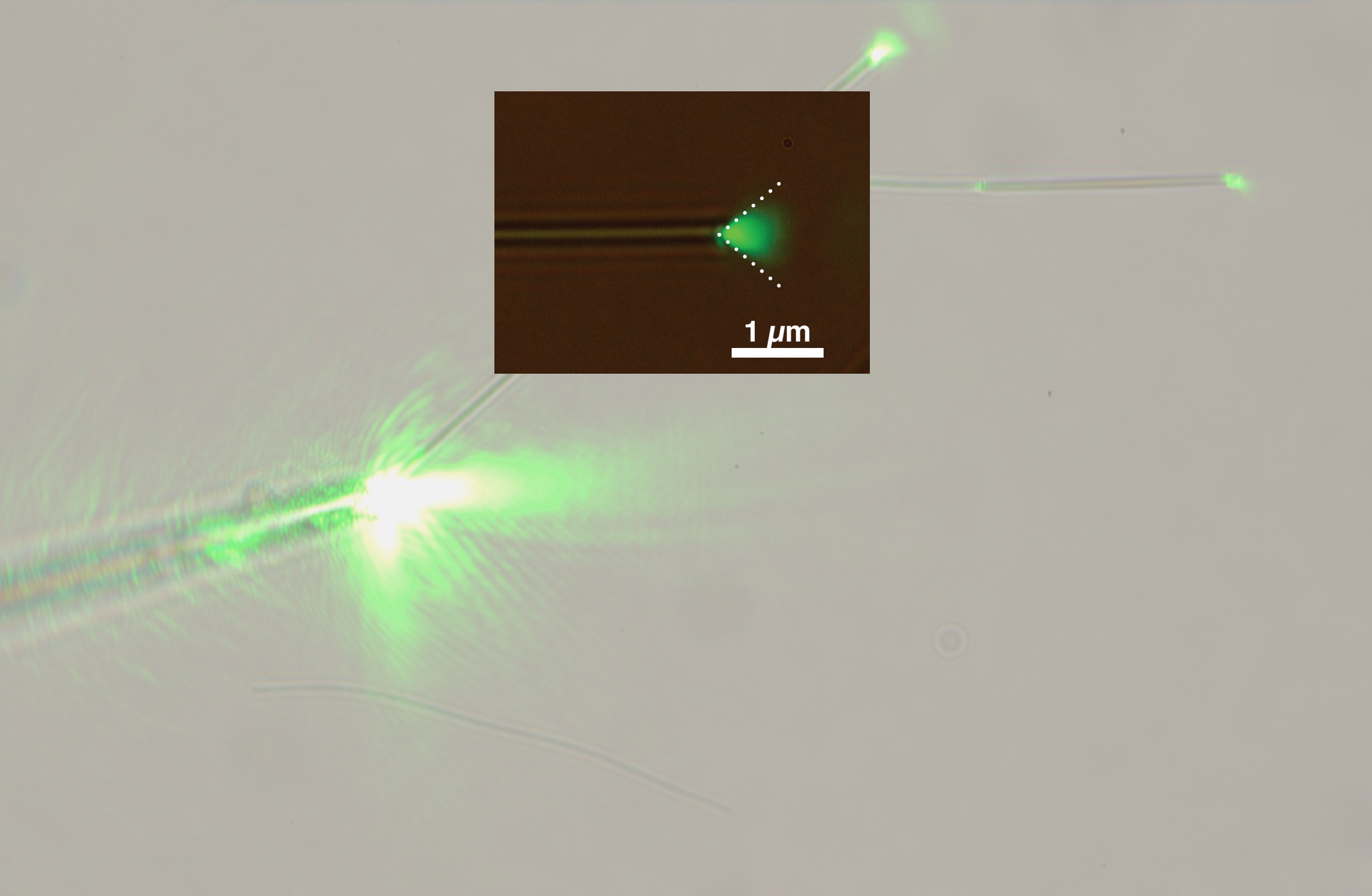
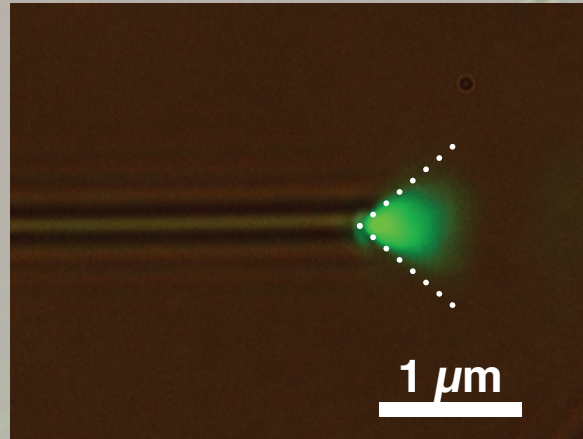

Manipulating light at the nanoscale

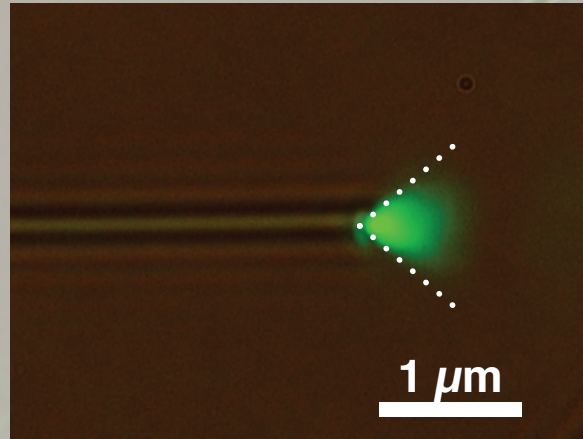

FDTD simulation

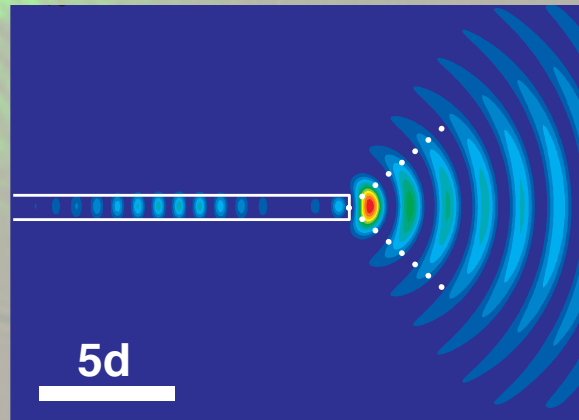

Manipulating light at the nanoscale

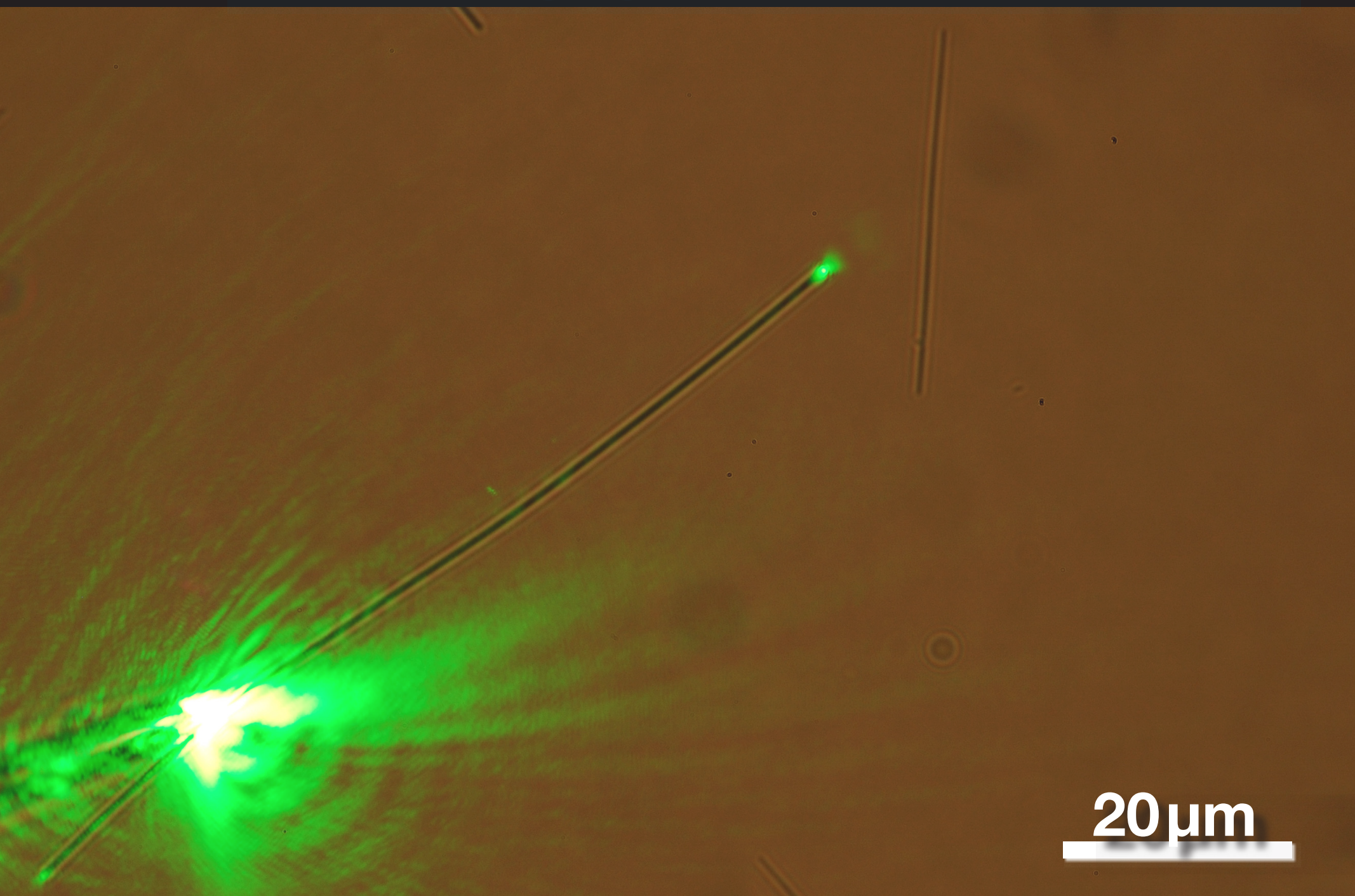

20 μm

Manipulating light at the nanoscale

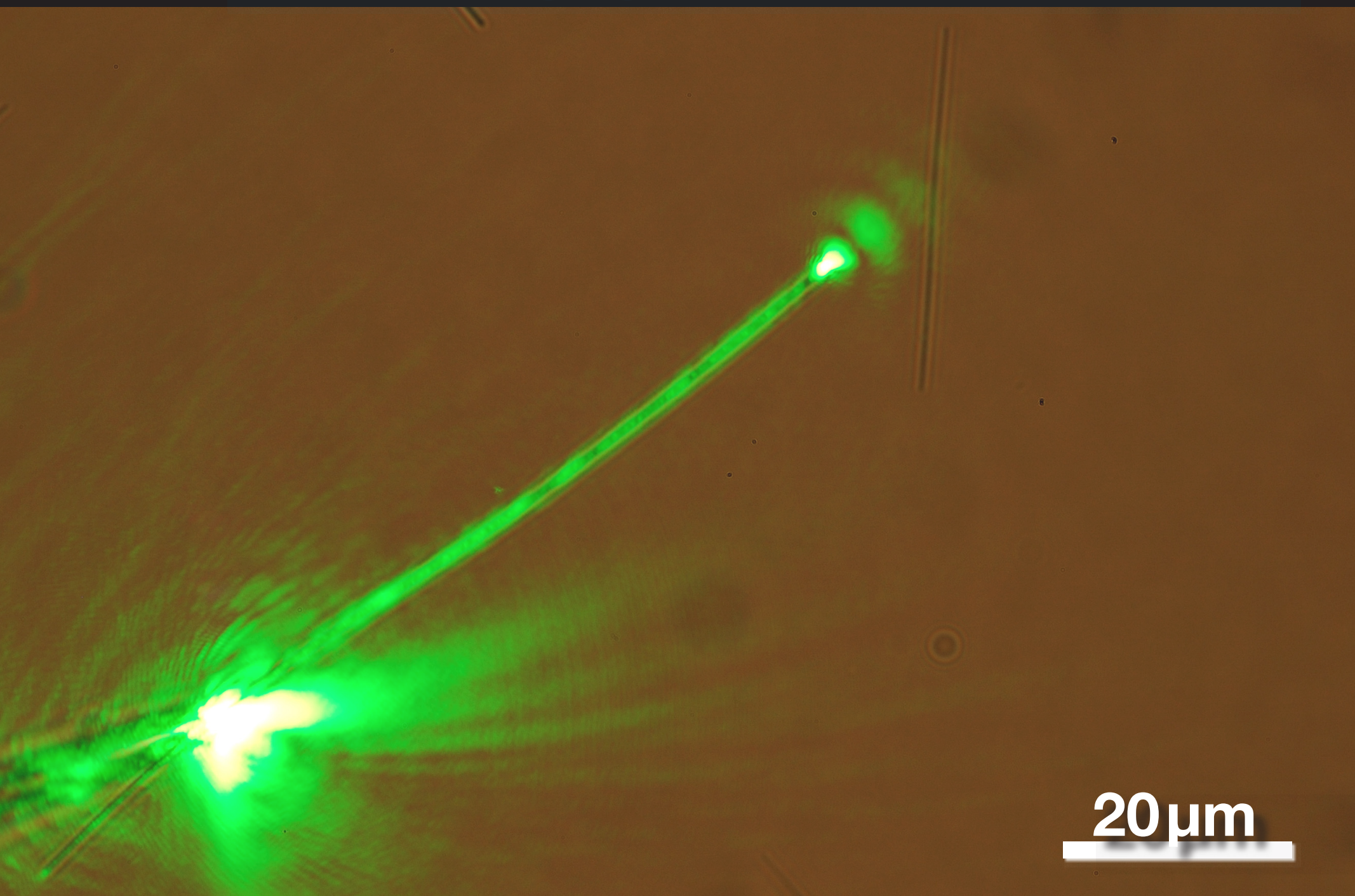

20 μm

Manipulating light at the nanoscale

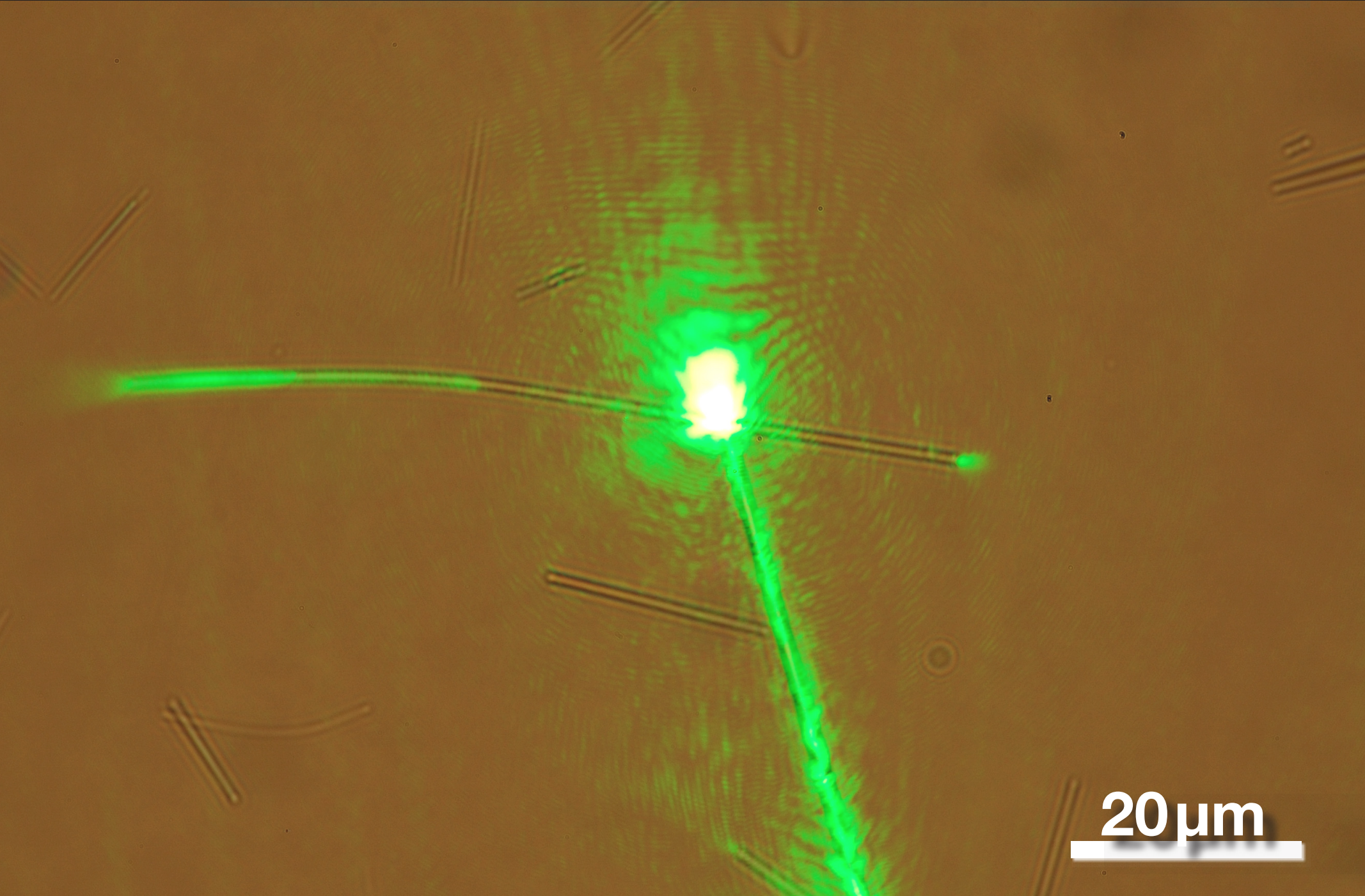

20 μm

Manipulating light at the nanoscale

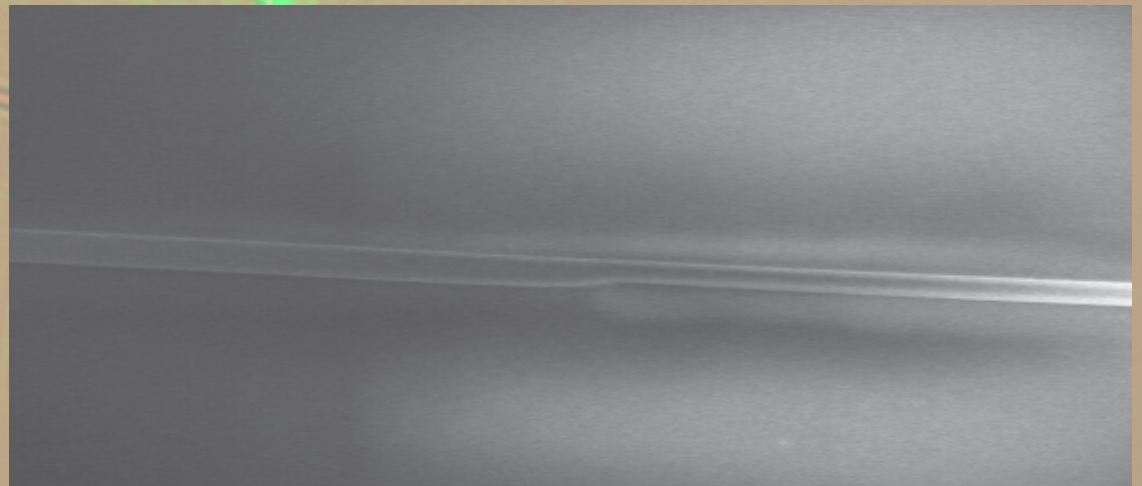
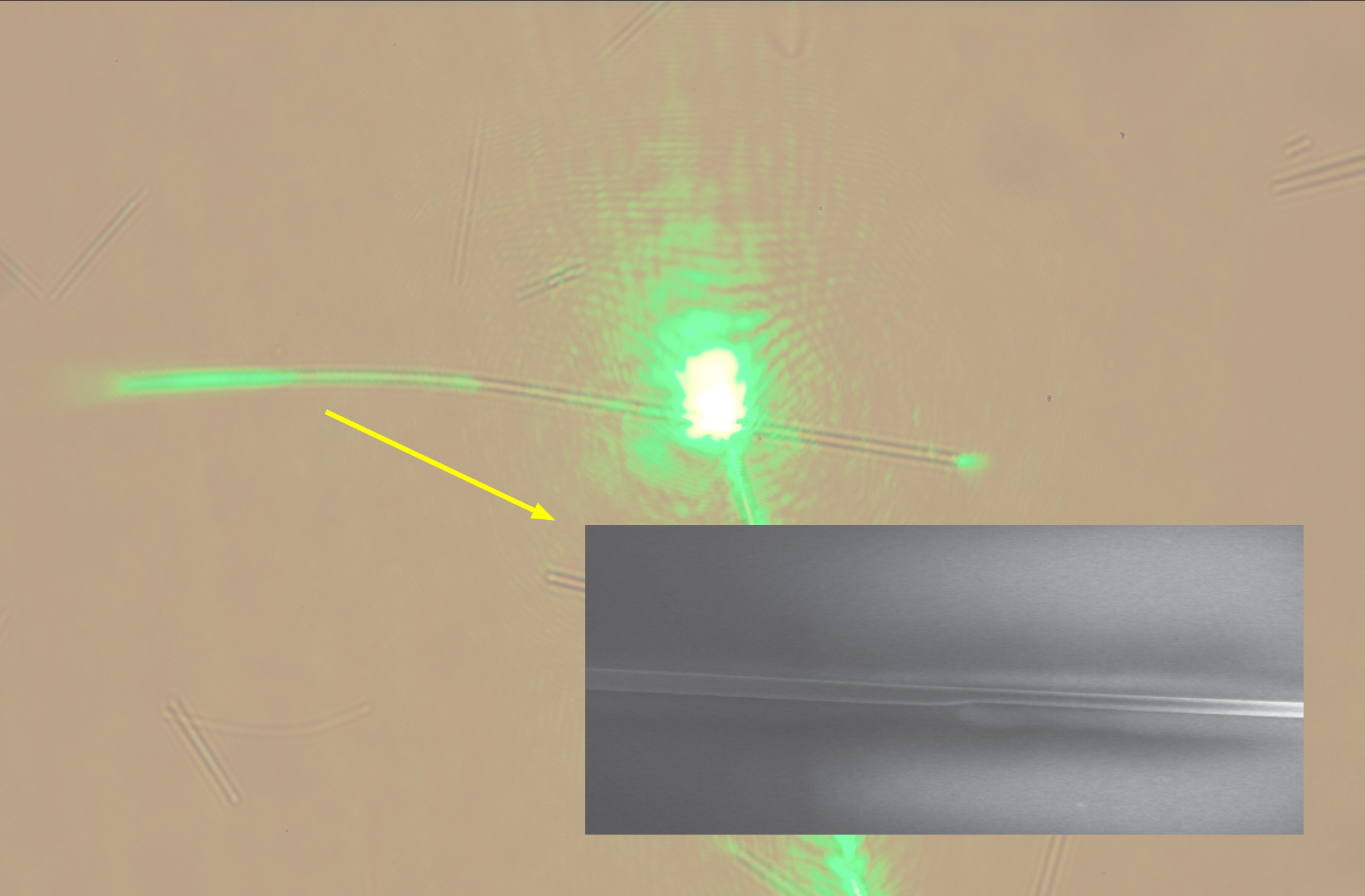

Manipulating light at the nanoscale

large diameter:
multimode

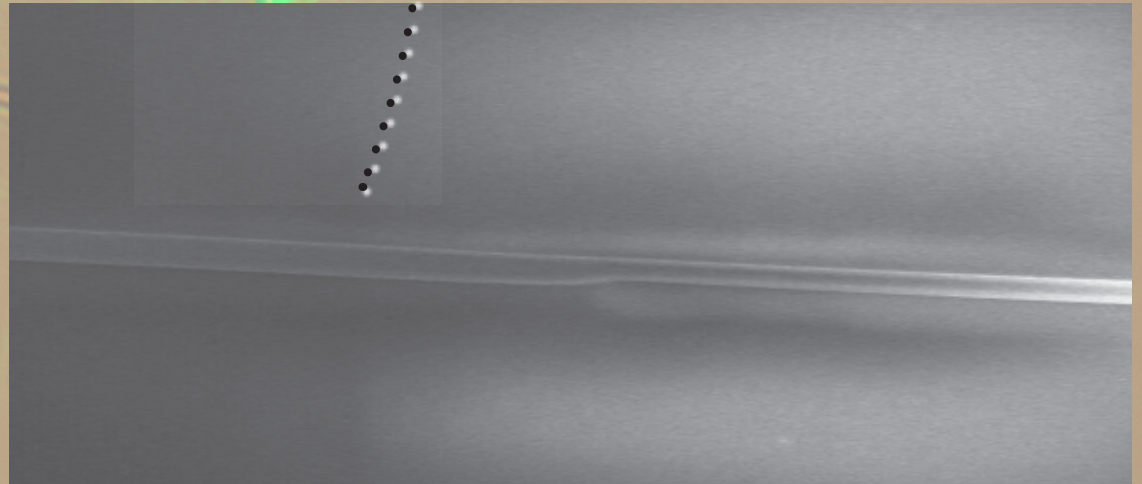

Manipulating light at the nanoscale

small diameter:
single mode

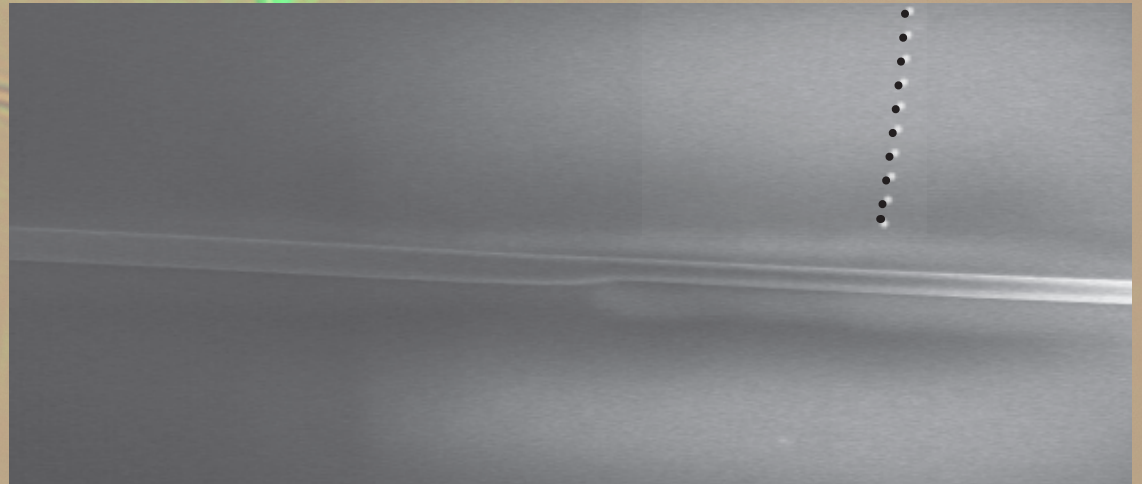

Manipulating light at the nanoscale

Points to keep in mind:

- **low loss**
- **large evanescent field**
- **convenient coupling to nanoscale**

Outline

- waveguiding
- silica nanowires
- manipulating light at the nanoscale
- nanoscale nonlinear optics

Nanoscale nonlinear optics

nonlinear dispersion: $n = n_0 + n_2 I$

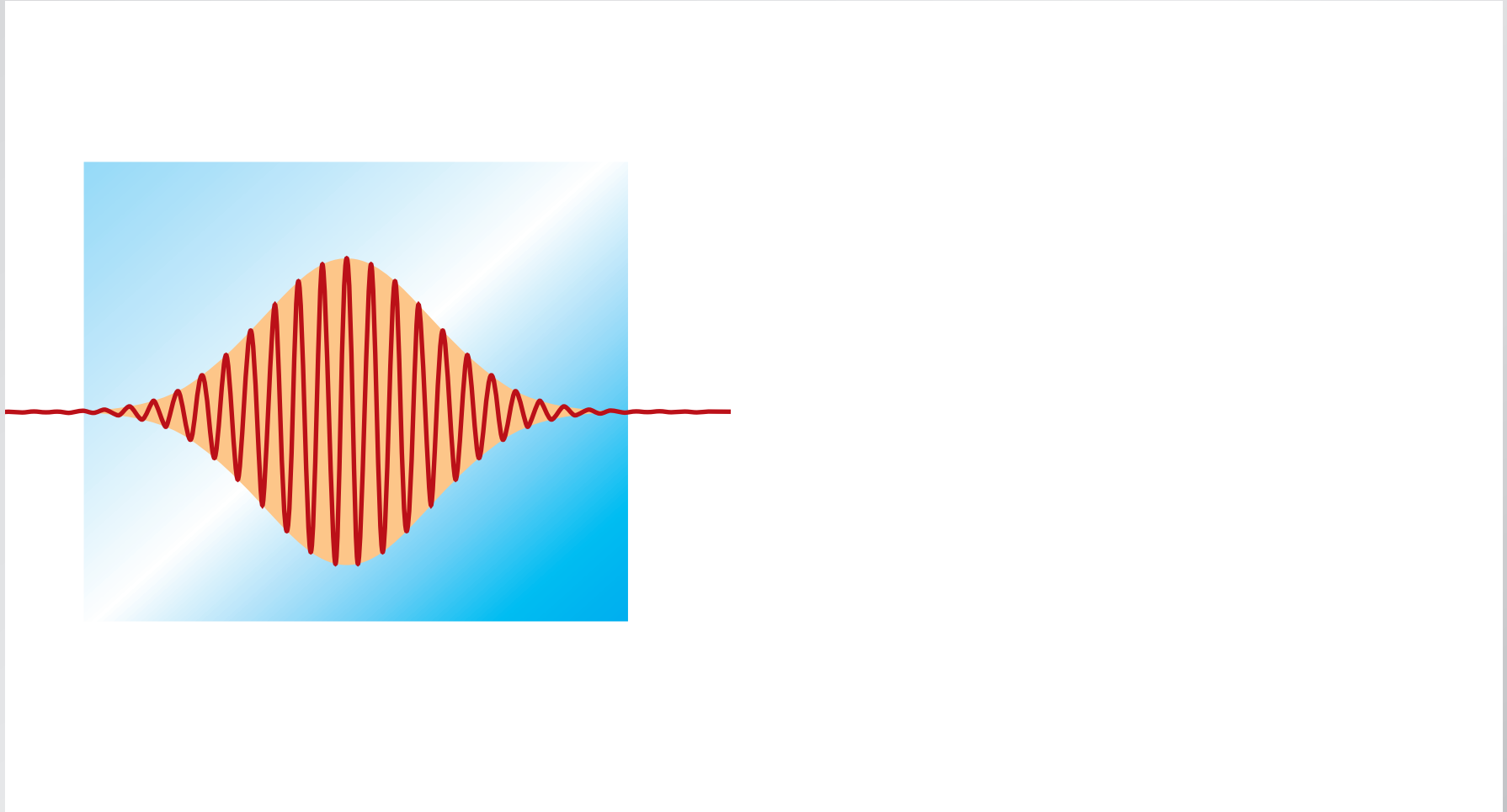

Nanoscale nonlinear optics

nonlinear dispersion: $n = n_0 + n_2 I$

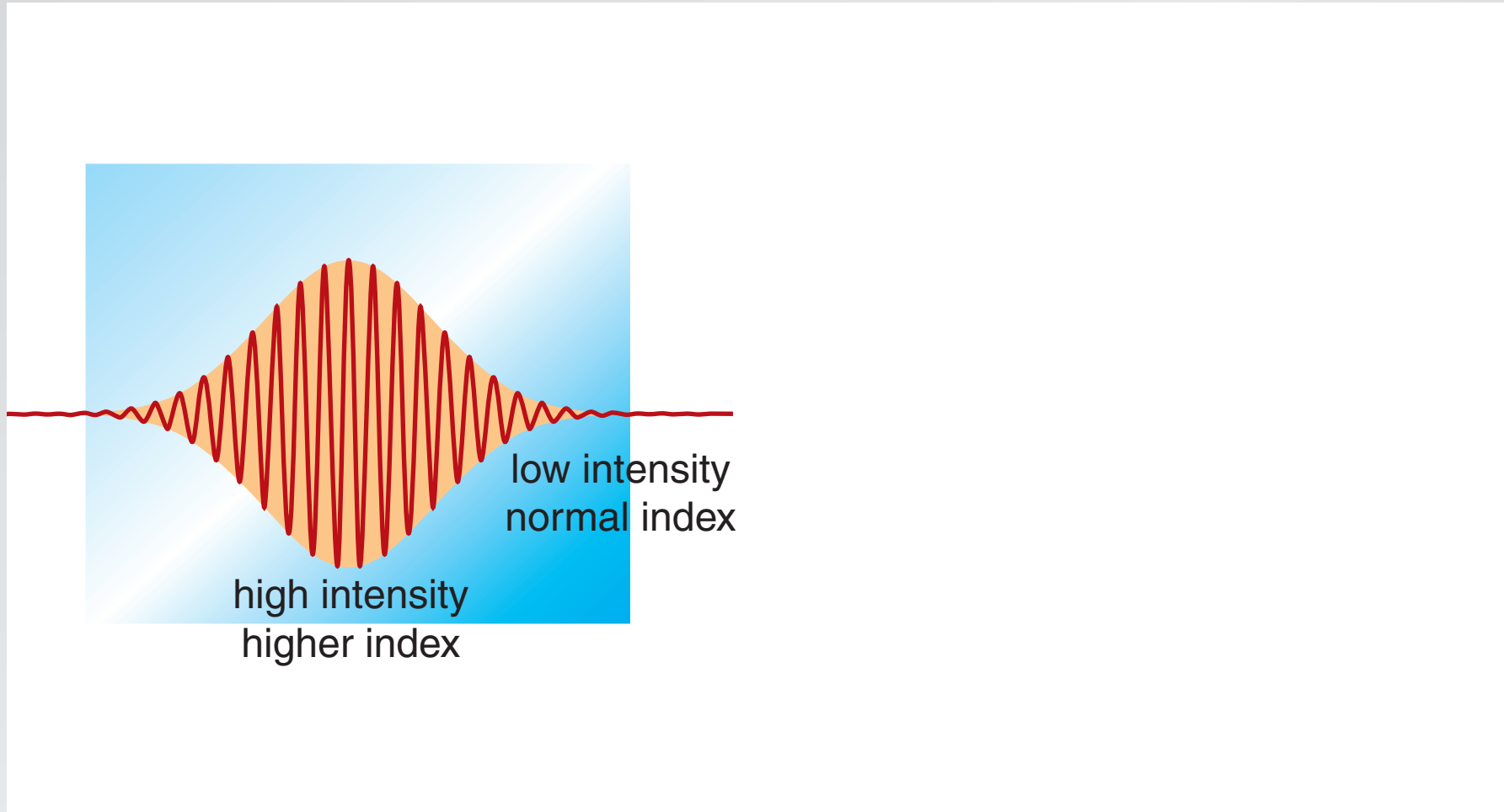

Nanoscale nonlinear optics

nonlinear dispersion: $n = n_0 + n_2 I$

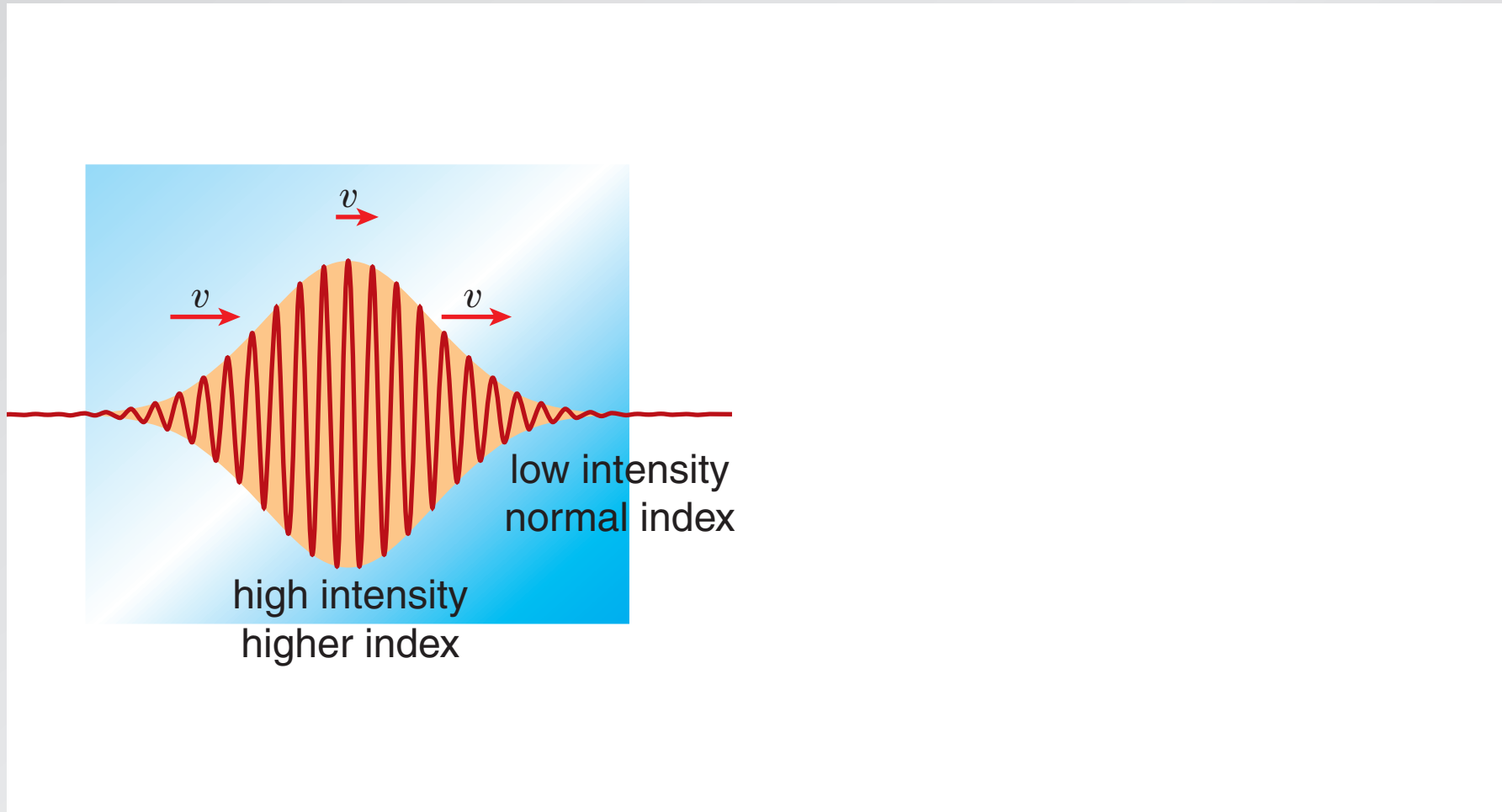

Nanoscale nonlinear optics

nonlinear dispersion: $n = n_0 + n_2 I$

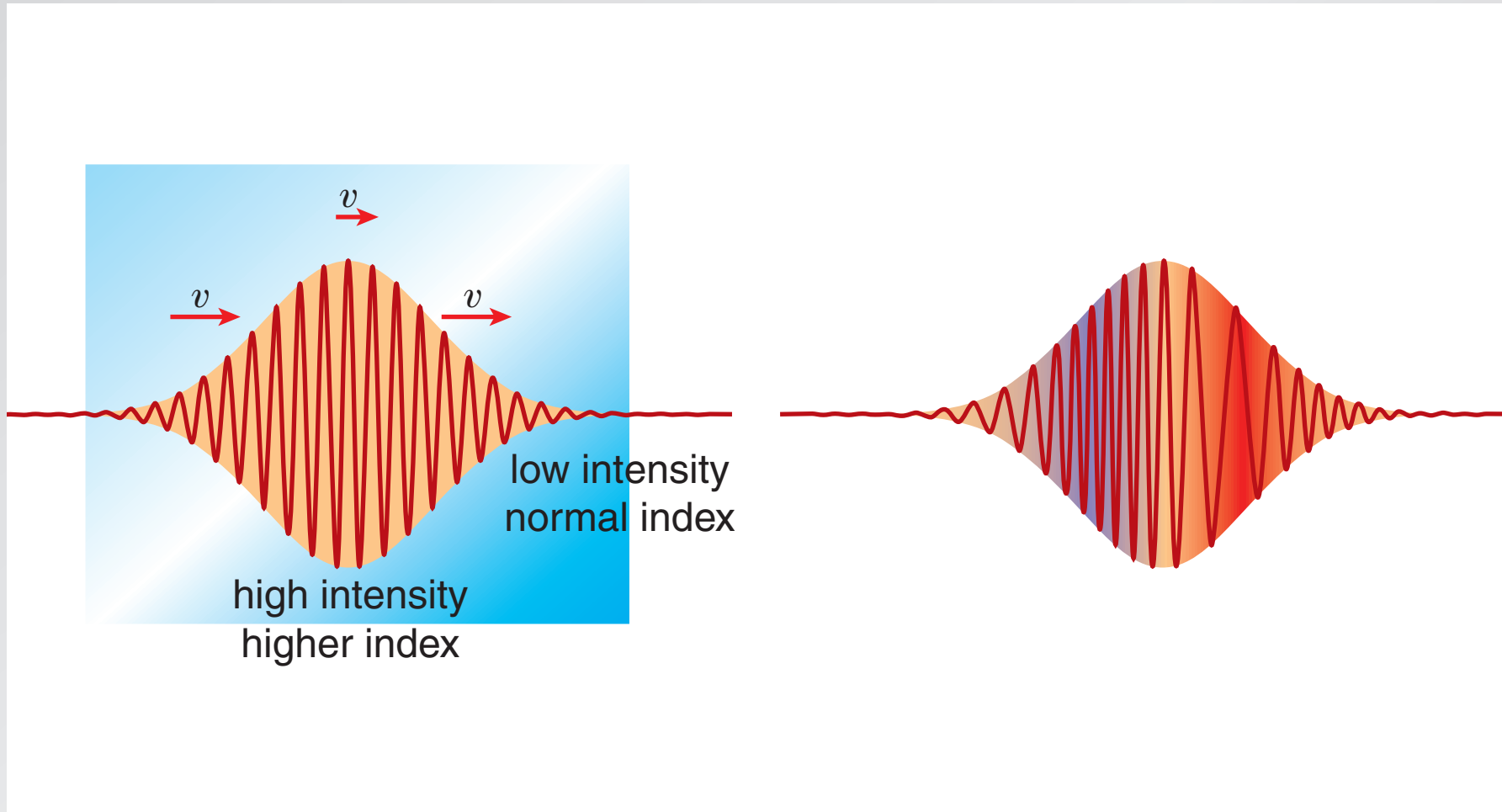

Nanoscale nonlinear optics

nonlinear dispersion: $n = n_0 + n_2 I$

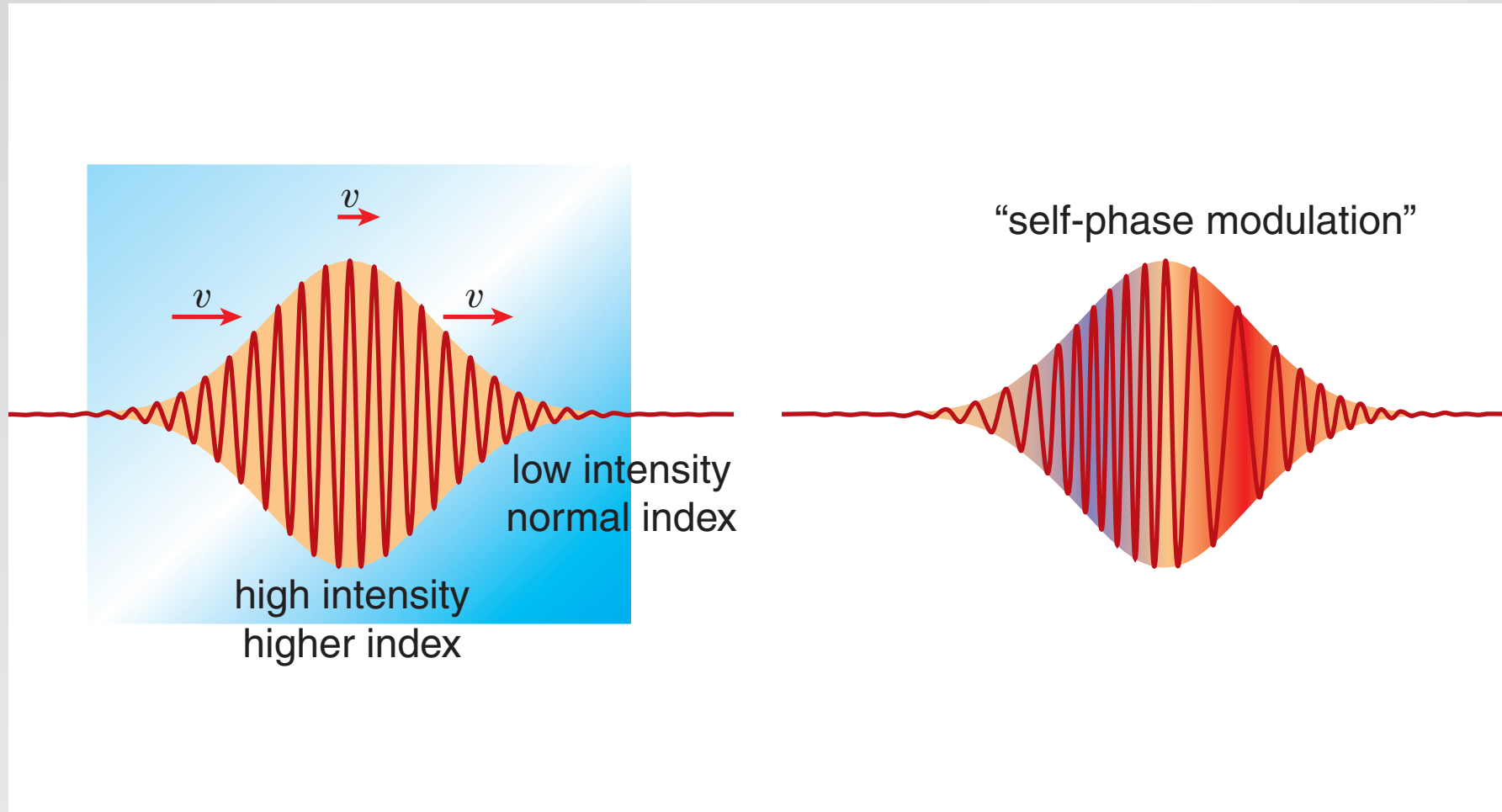

Nanoscale nonlinear optics

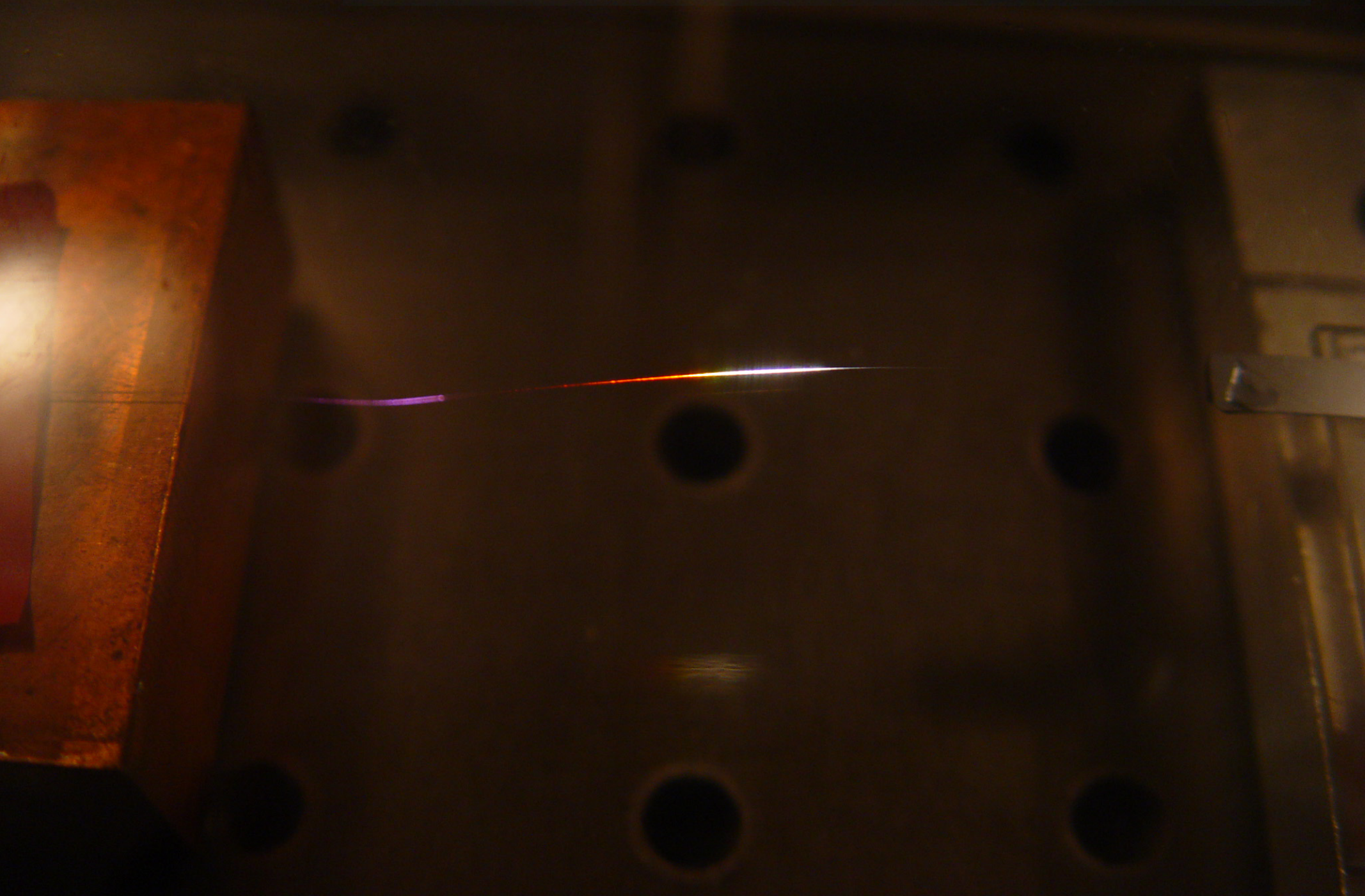

Nanoscale nonlinear optics



Nanoscale nonlinear optics

strong confinement \longrightarrow **high intensity**

Nanoscale nonlinear optics

mode field diameter ($\lambda = 800$ nm)

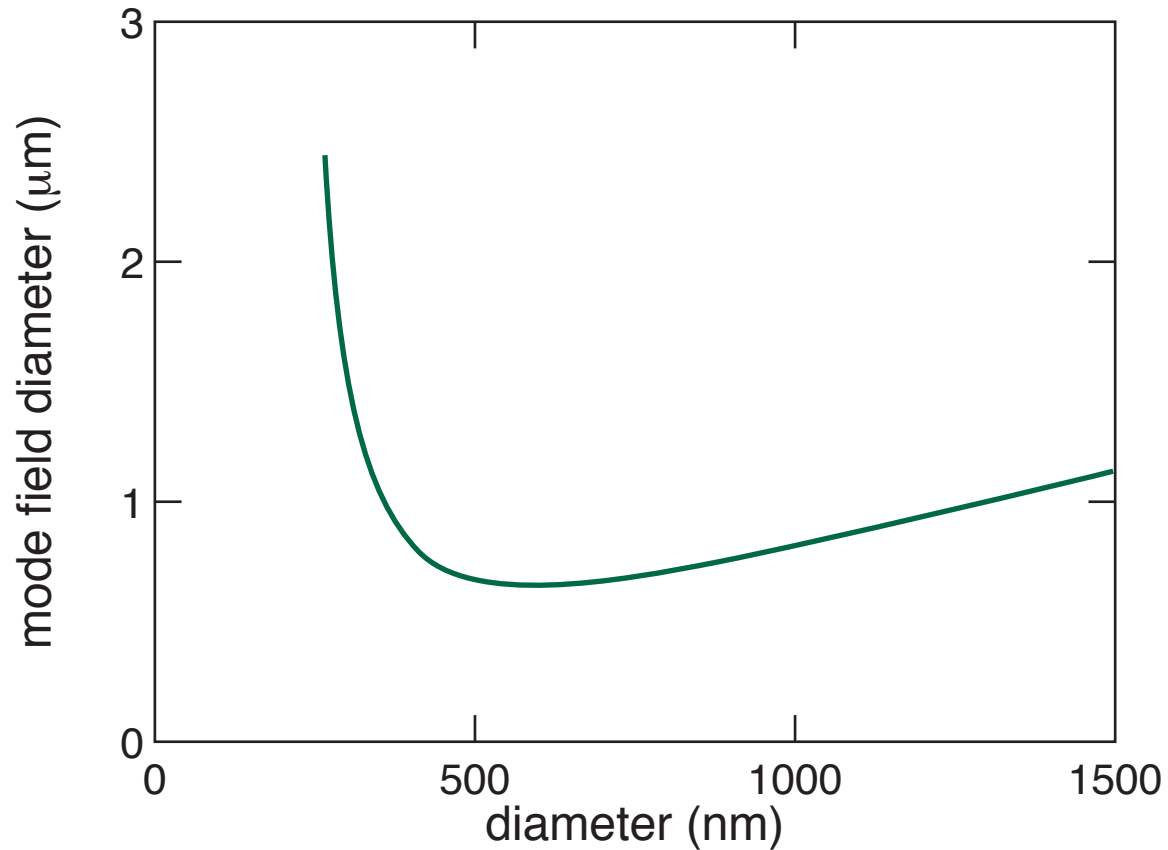

M.A. Foster, *et al.*, *Optics Express*, 12, 2880 (2004)

Nanoscale nonlinear optics

mode field diameter ($\lambda = 800$ nm)

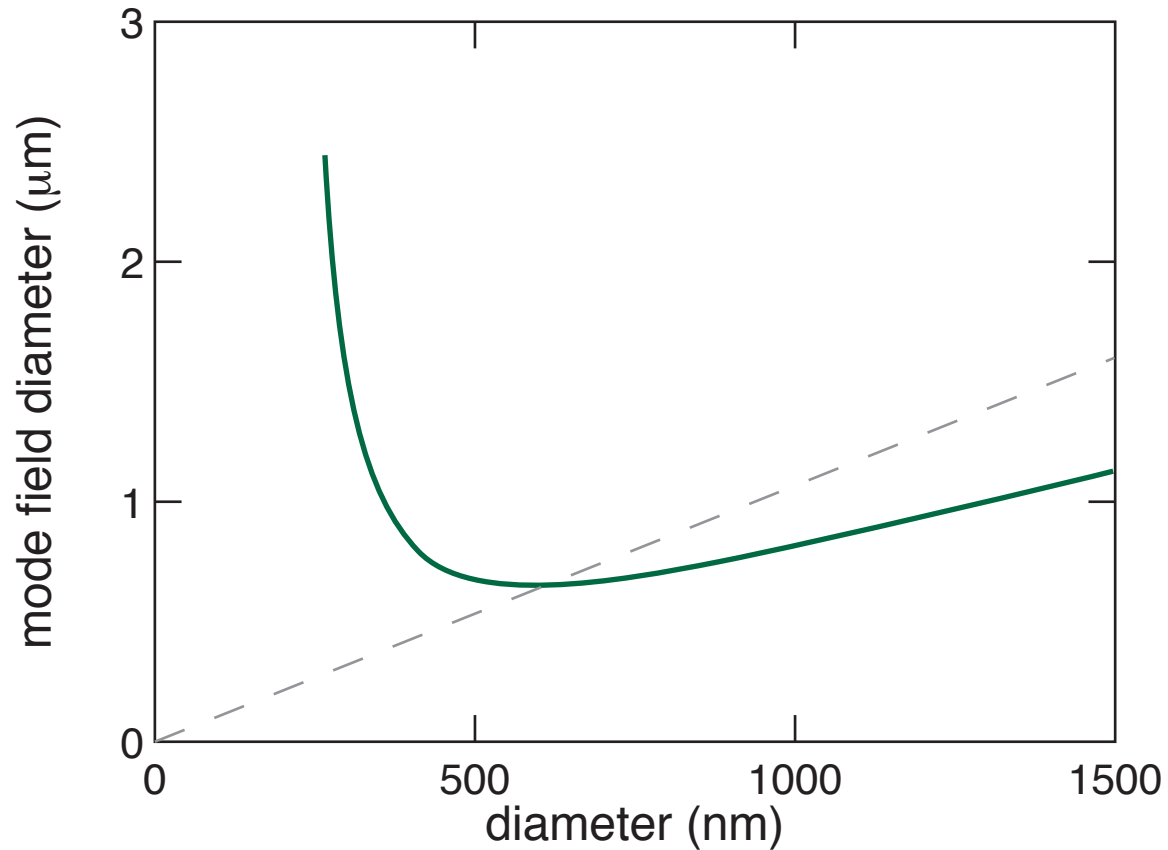

M.A. Foster, et al., *Optics Express*, 12, 2880 (2004)

Nanoscale nonlinear optics

nonlinear parameter

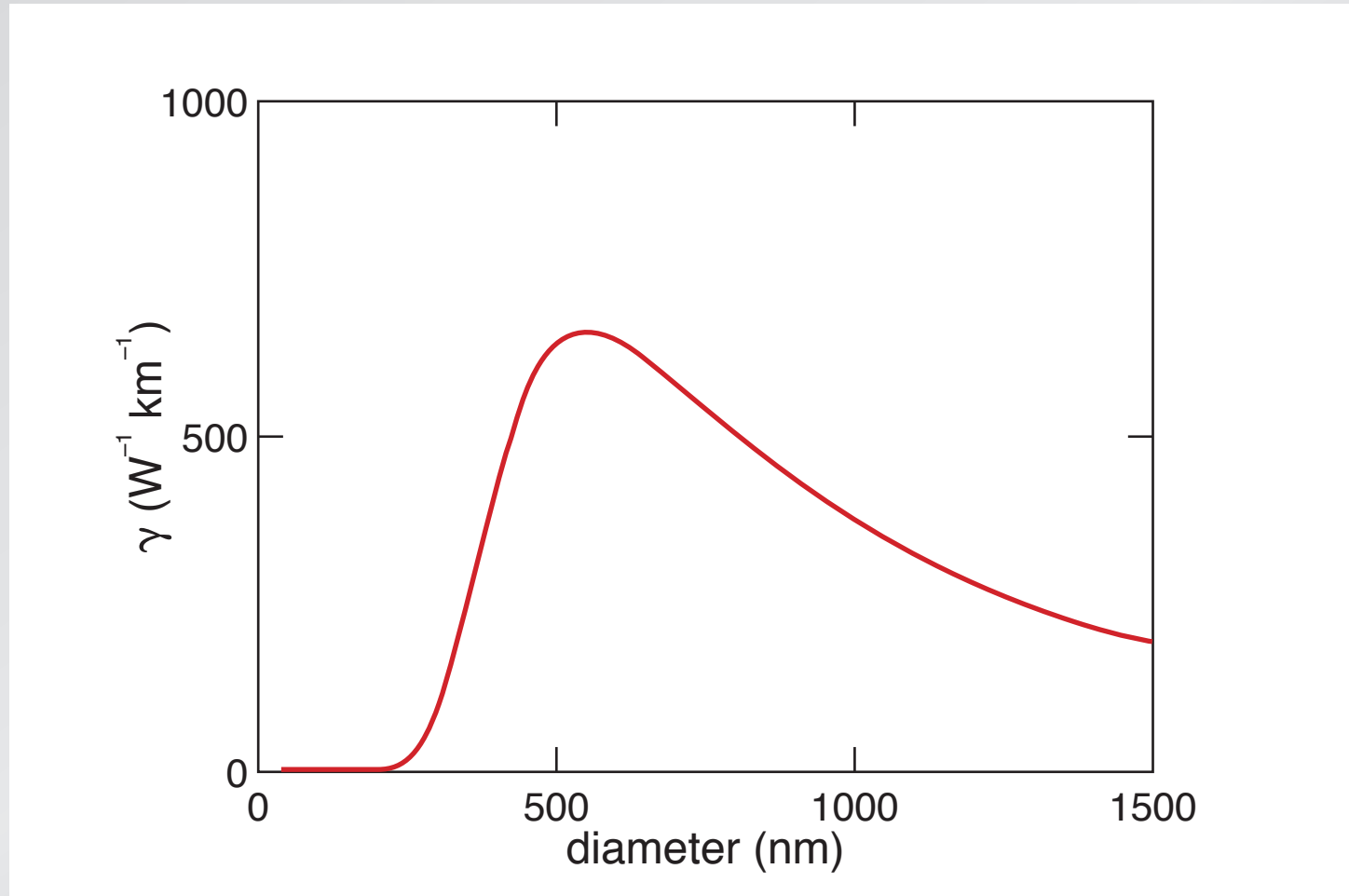

M.A. Foster, et al., *Optics Express*, 12, 2880 (2004)

Nanoscale nonlinear optics

dispersion important!

Nanoscale nonlinear optics

dispersion:

- **modal dispersion**
- **material dispersion**
- **waveguide dispersion**
- **nonlinear dispersion**

Nanoscale nonlinear optics

waveguide dispersion

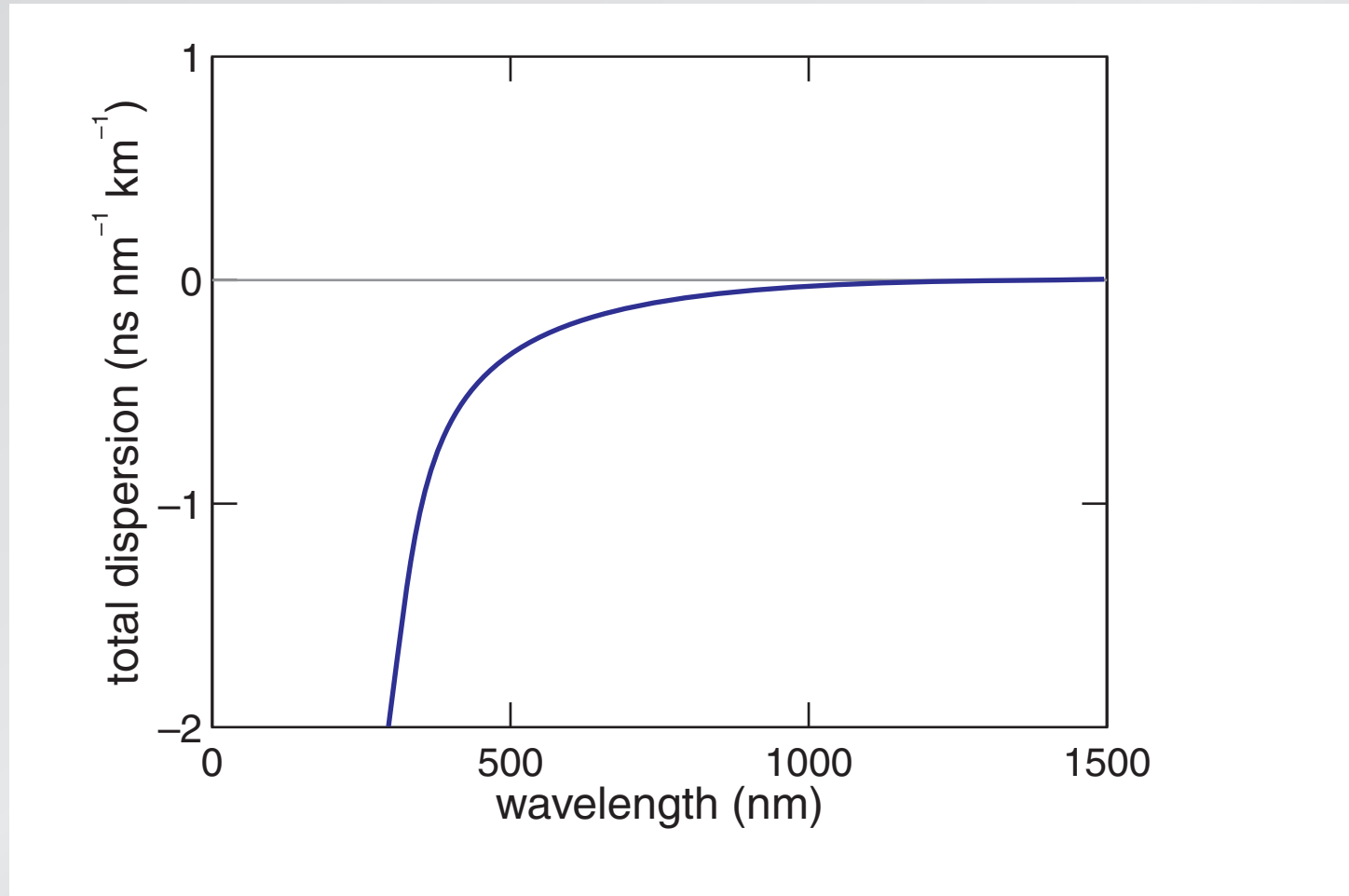

Nanoscale nonlinear optics

waveguide dispersion

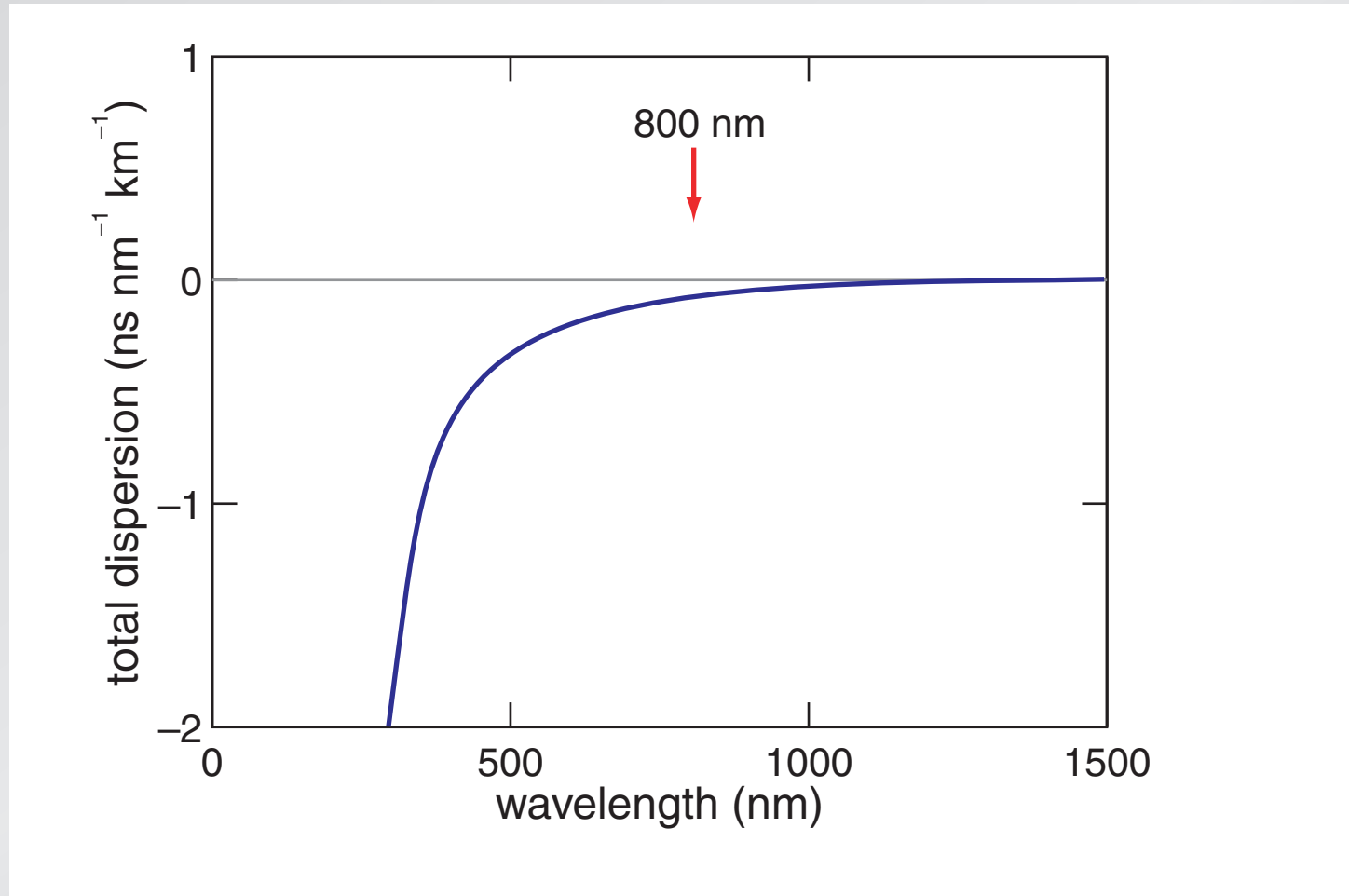

Nanoscale nonlinear optics

waveguide dispersion

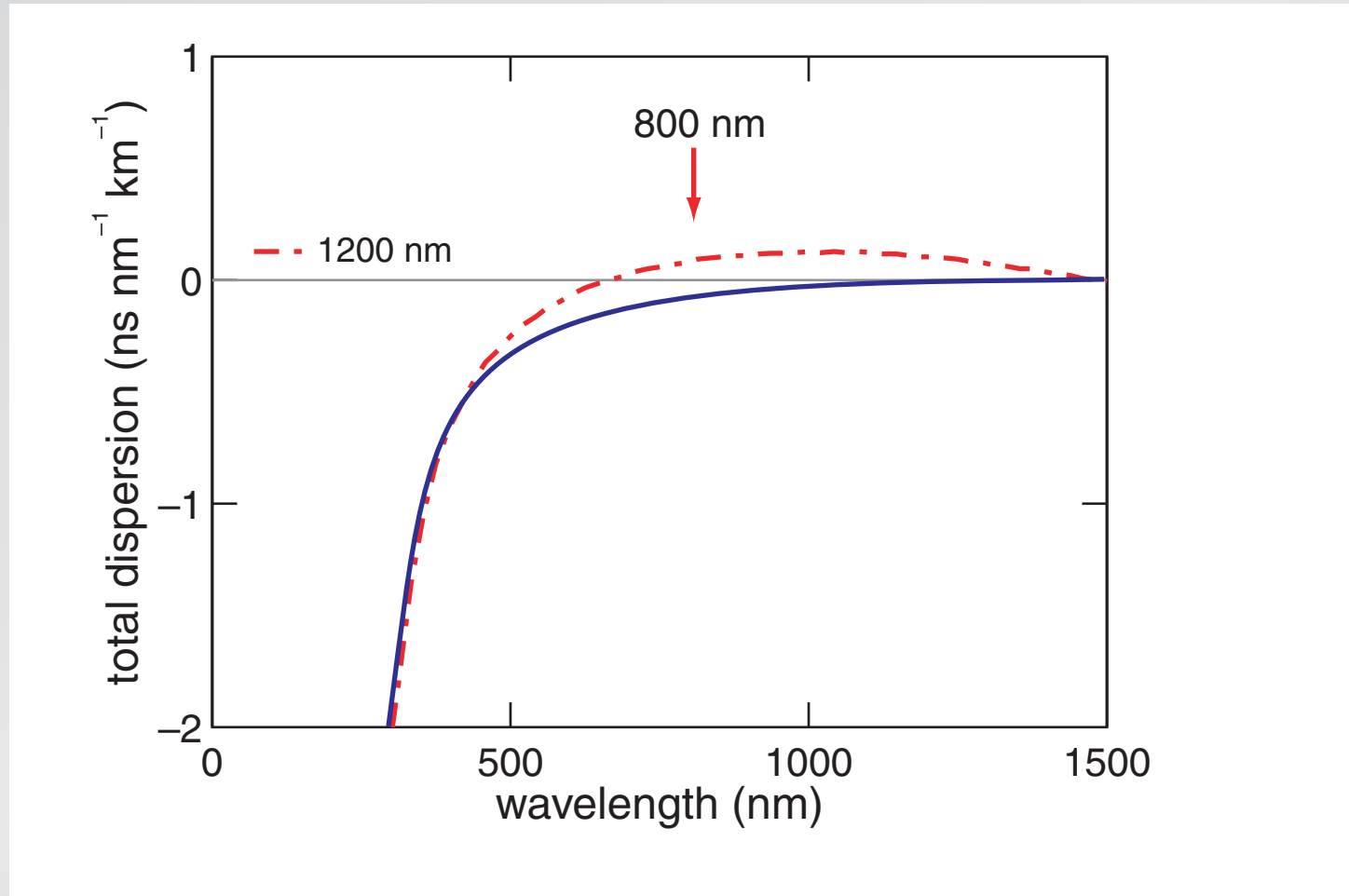

Nanoscale nonlinear optics

waveguide dispersion

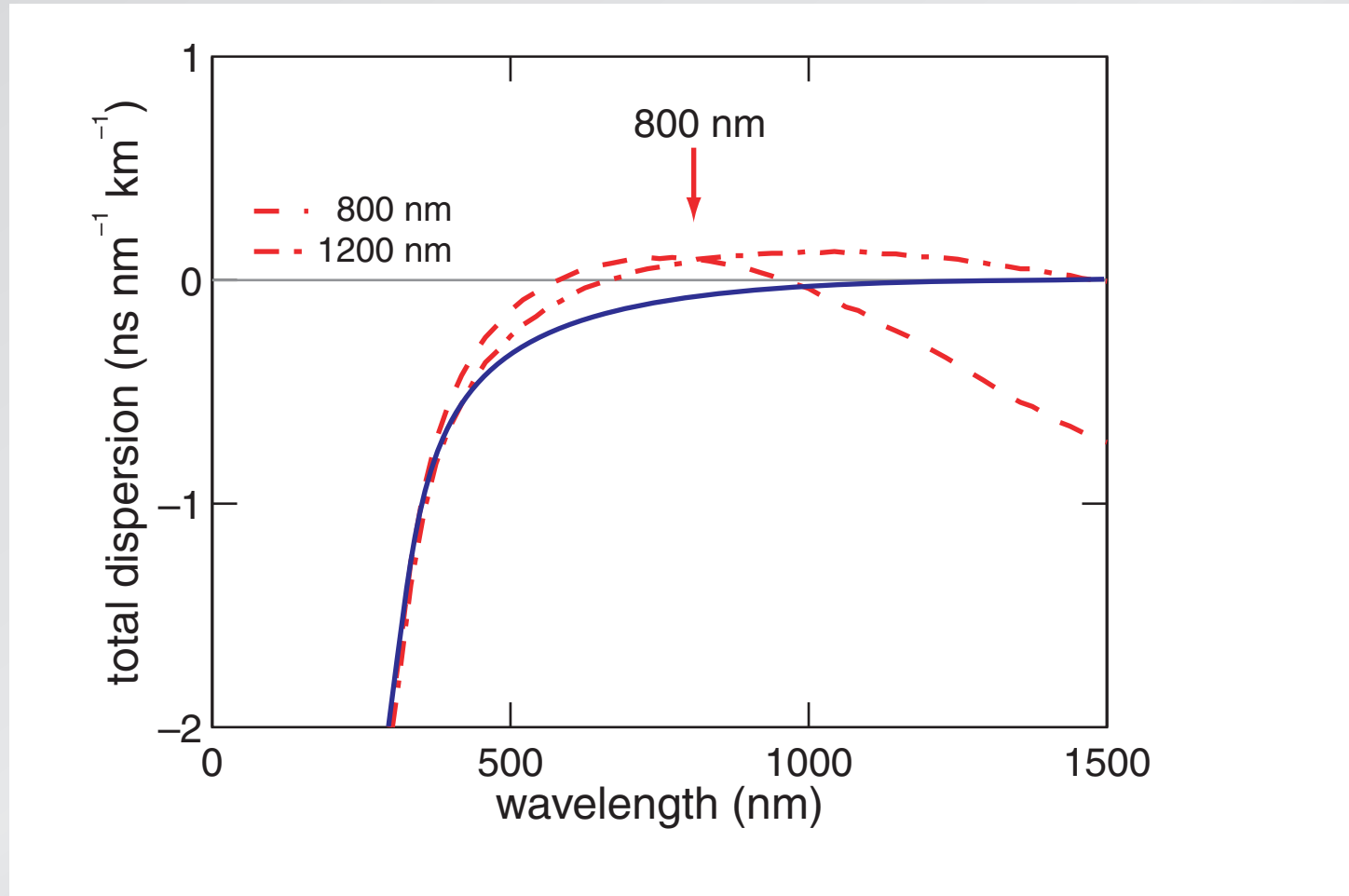

Nanoscale nonlinear optics

waveguide dispersion

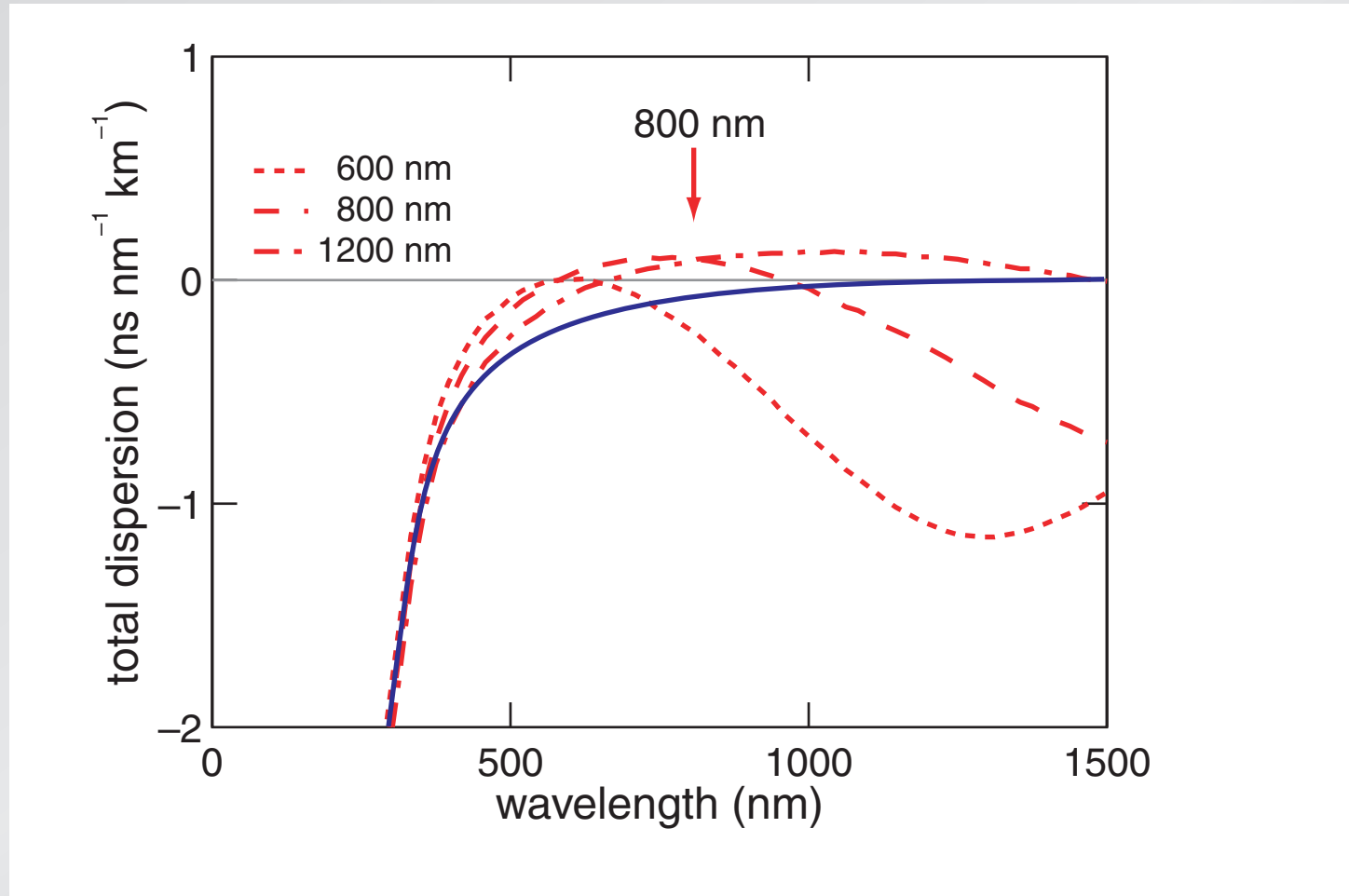

Nanoscale nonlinear optics

waveguide dispersion

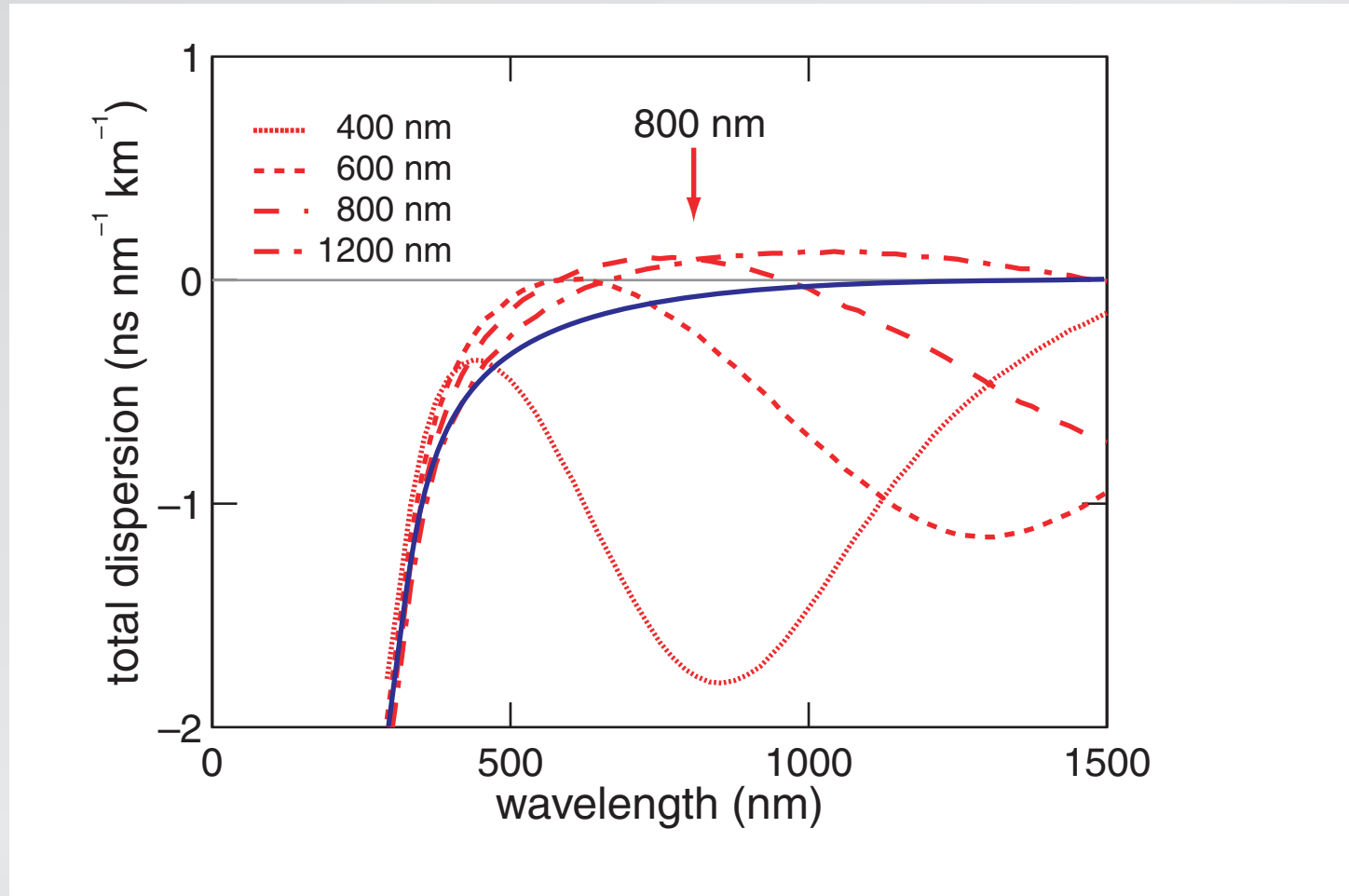

Nanoscale nonlinear optics

waveguide dispersion

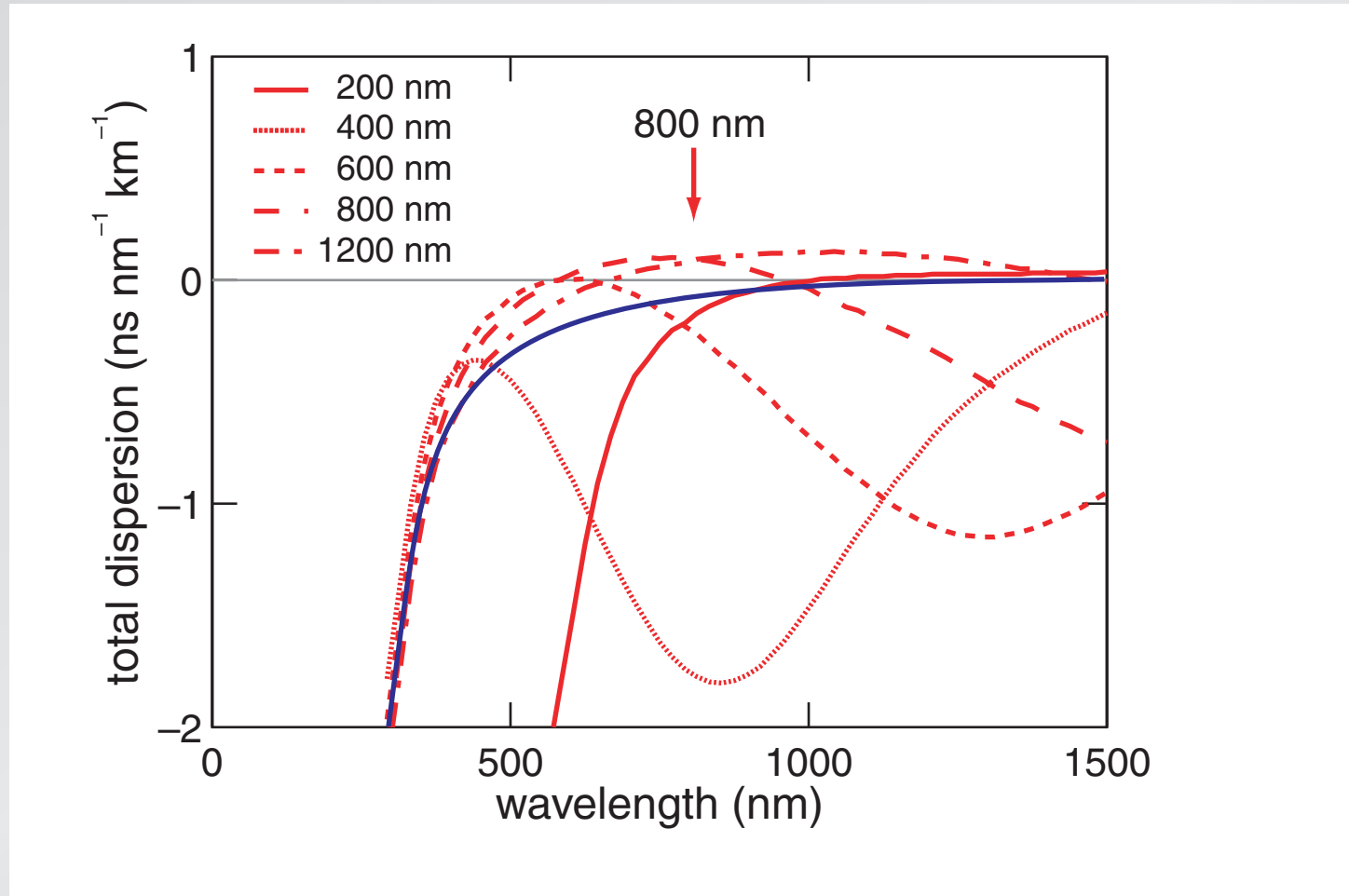

Nanoscale nonlinear optics

waveguide dispersion

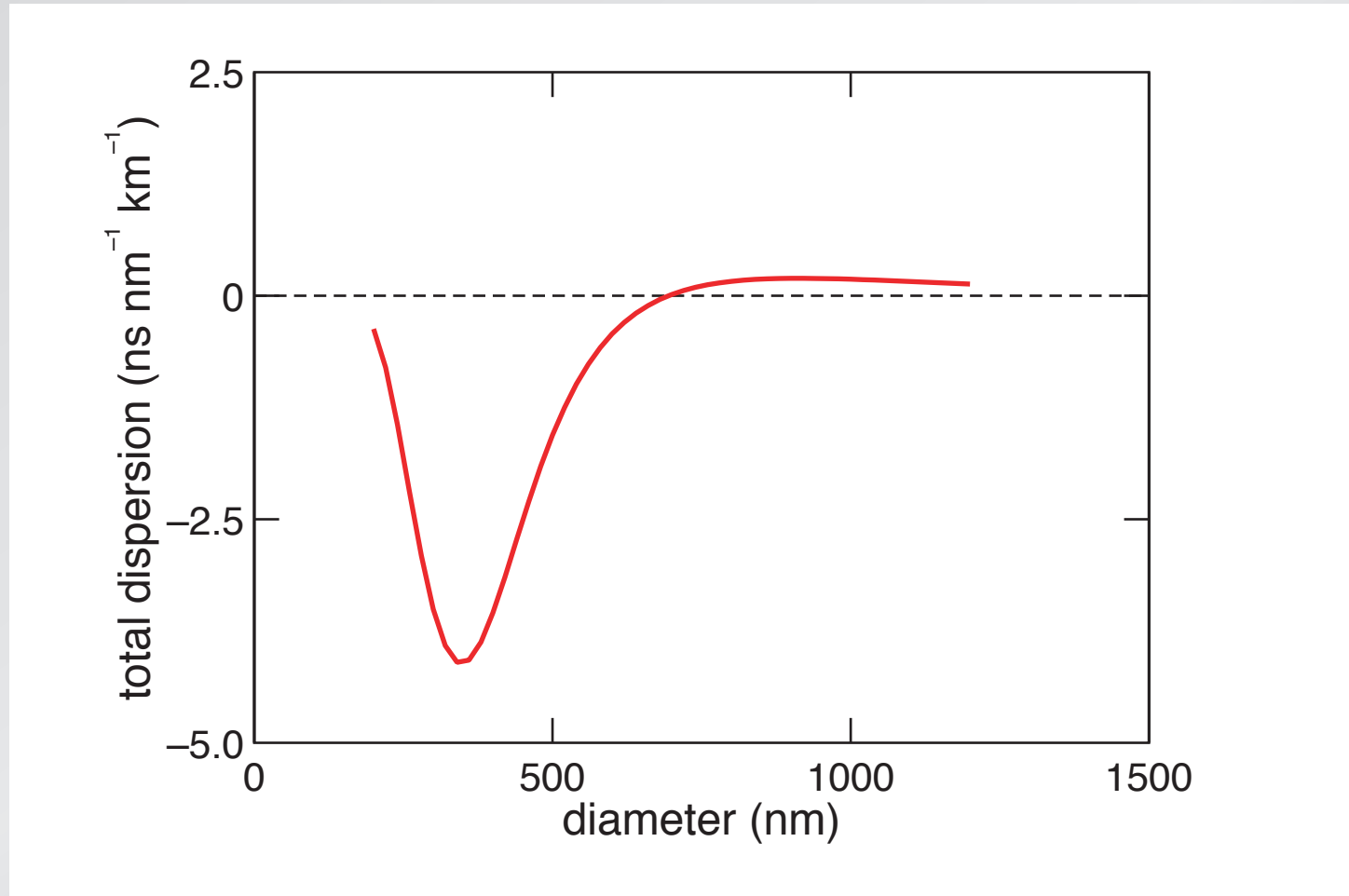

Nanoscale nonlinear optics

waveguide dispersion

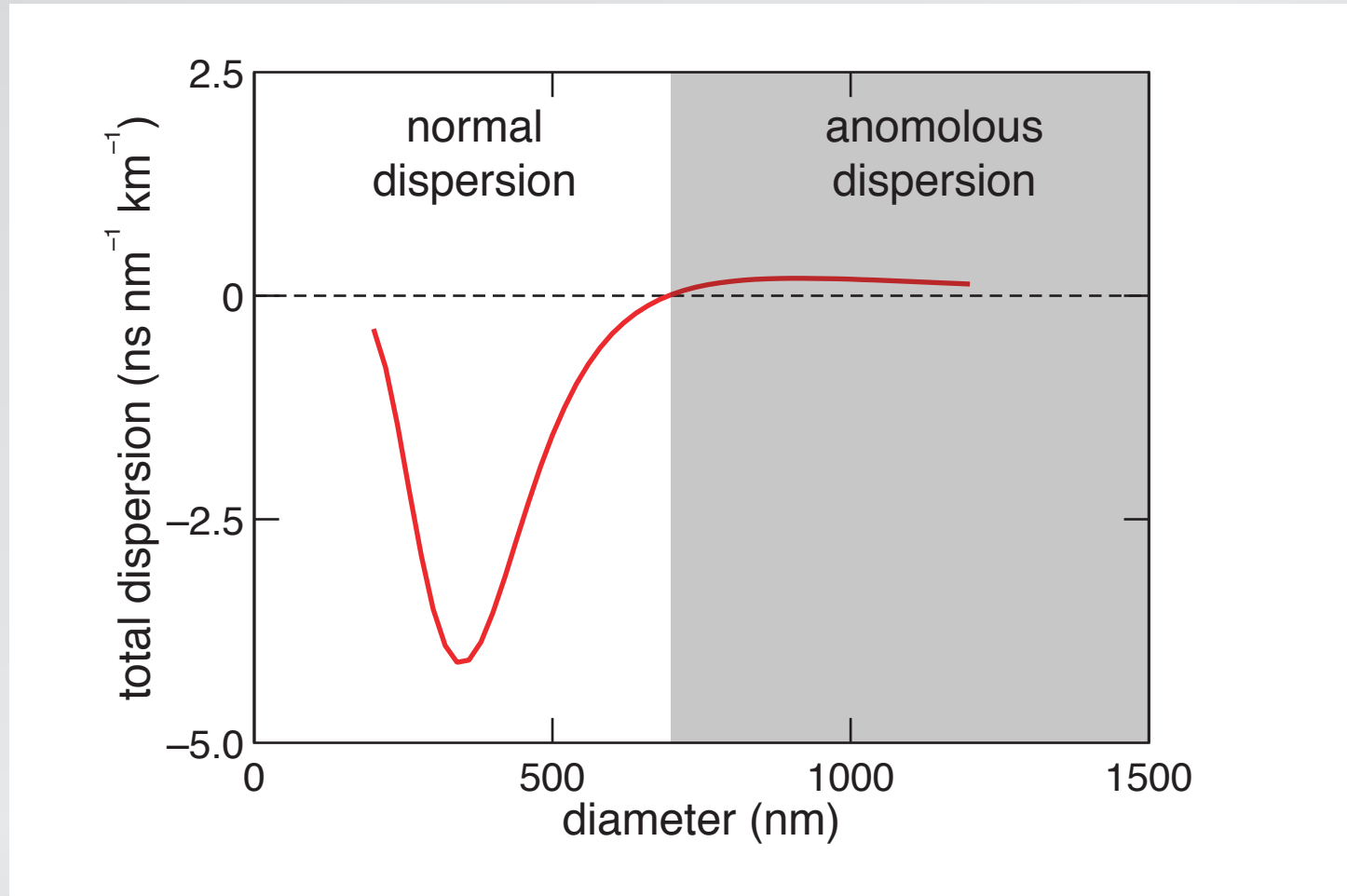

Nanoscale nonlinear optics

nonlinear parameter

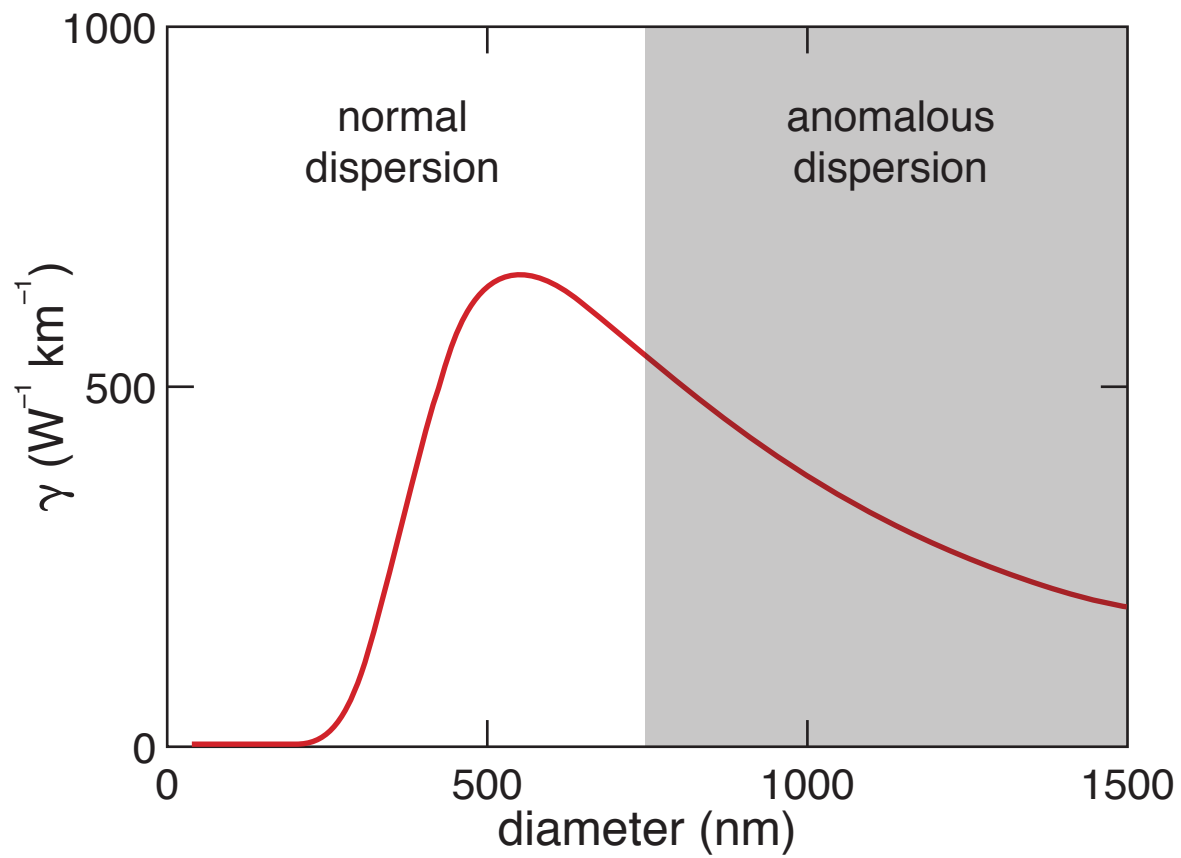

Nanoscale nonlinear optics

nanowire continuum generation

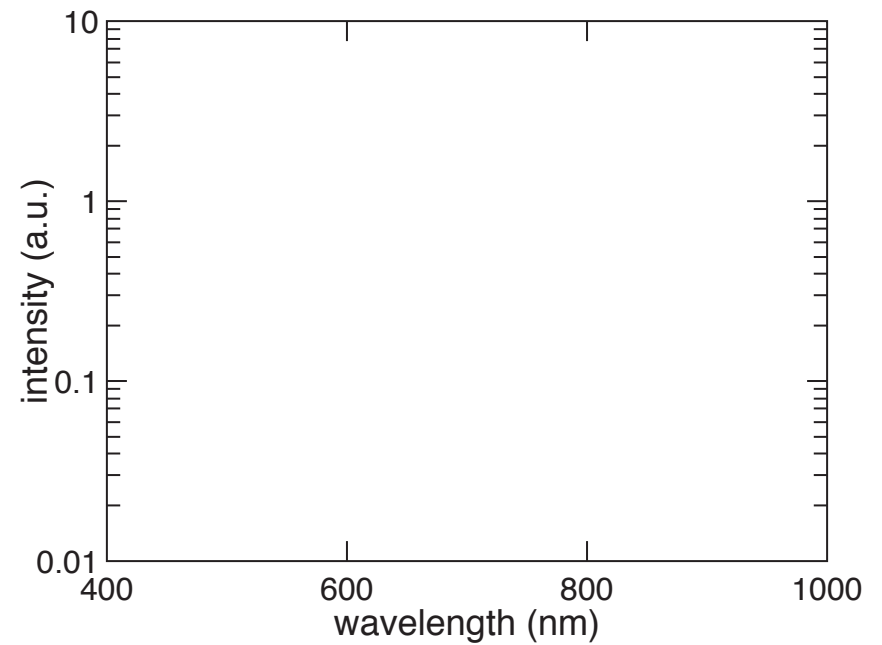
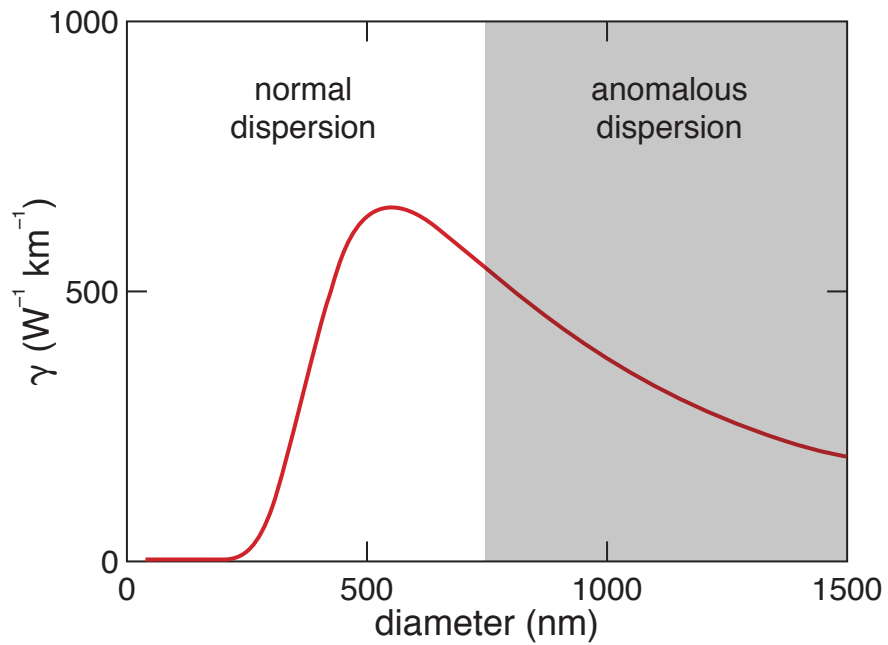

Nanoscale nonlinear optics

nanowire continuum generation

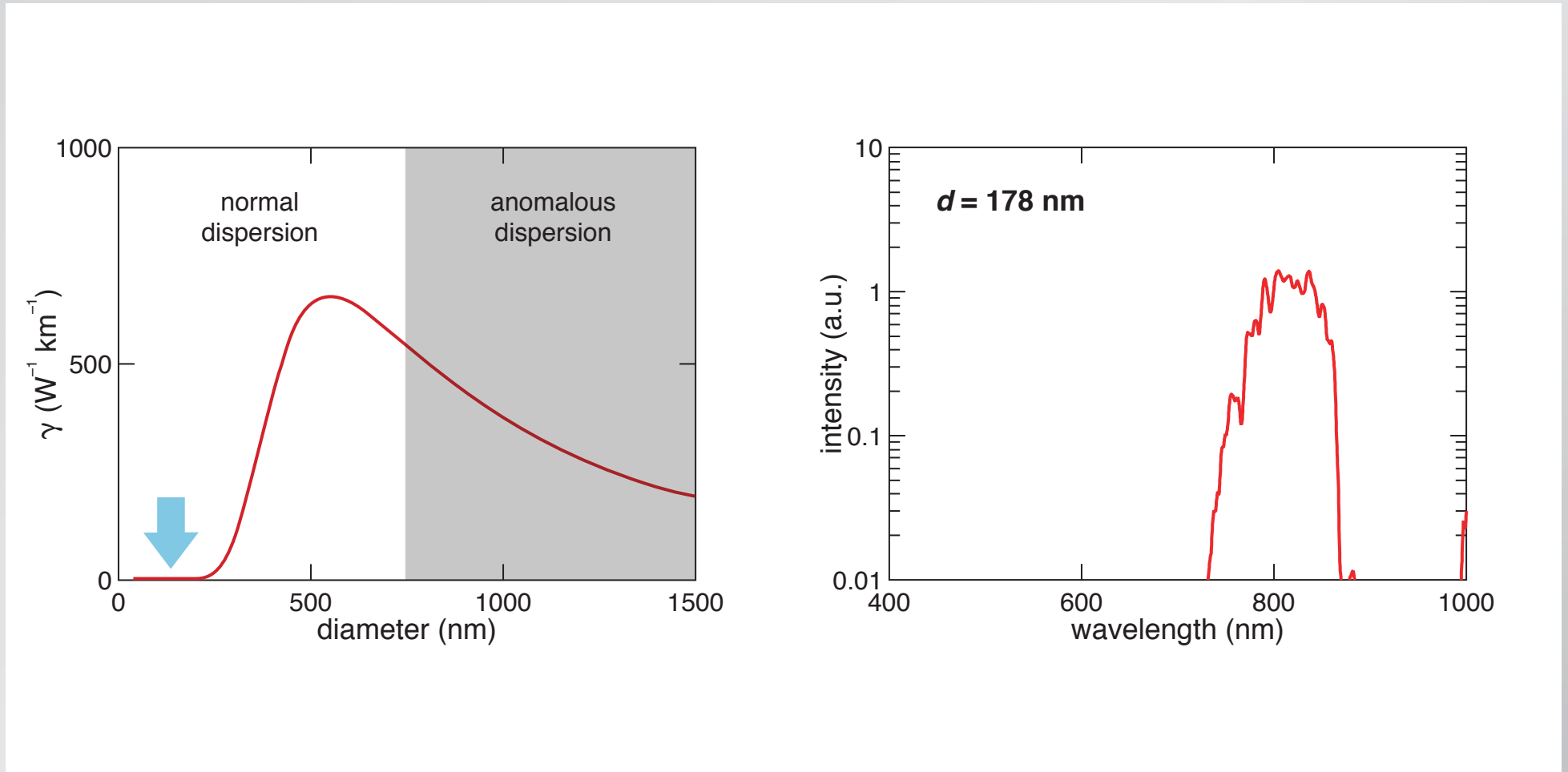

Nanoscale nonlinear optics

nanowire continuum generation

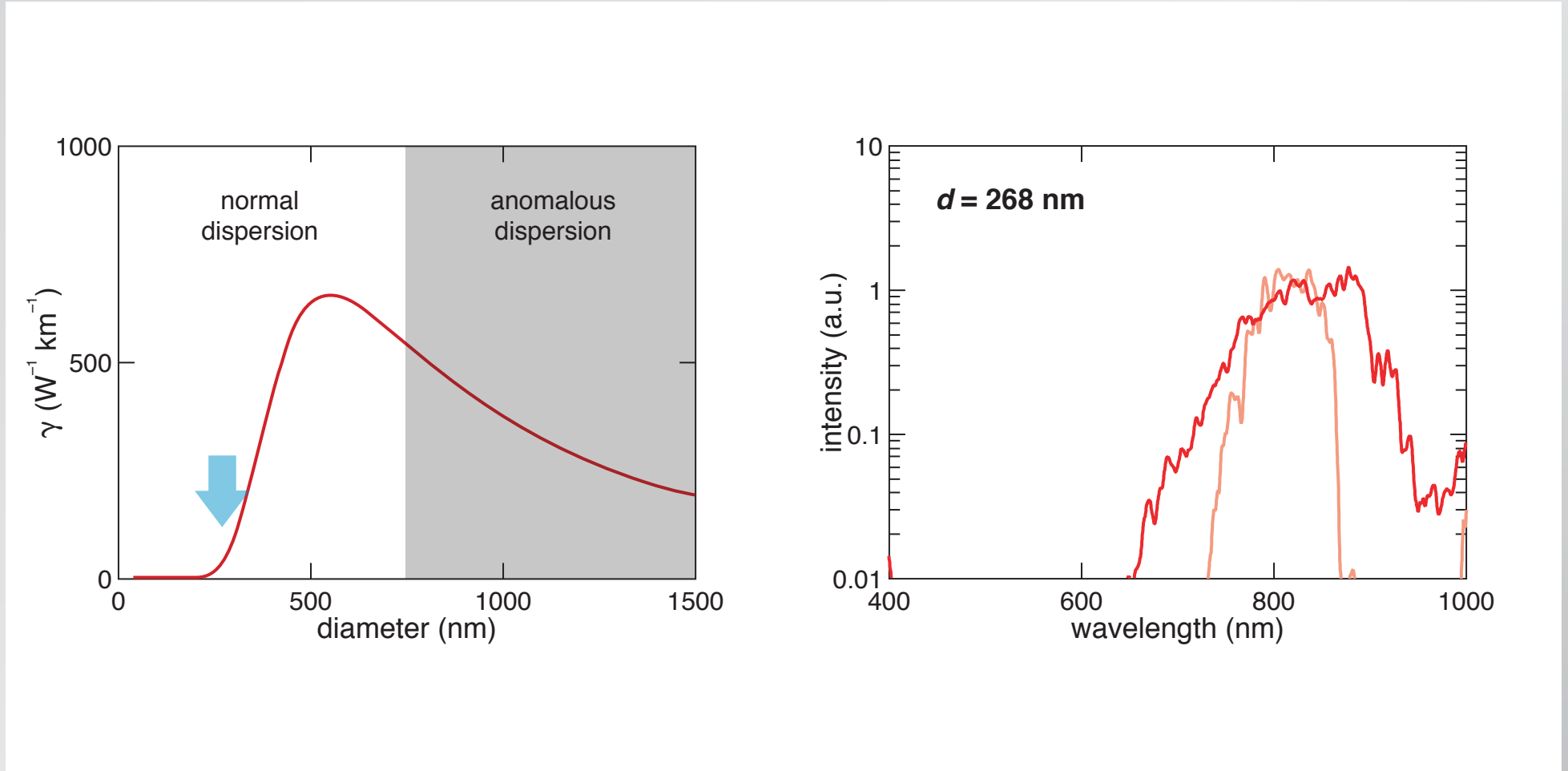

Nanoscale nonlinear optics

nanowire continuum generation

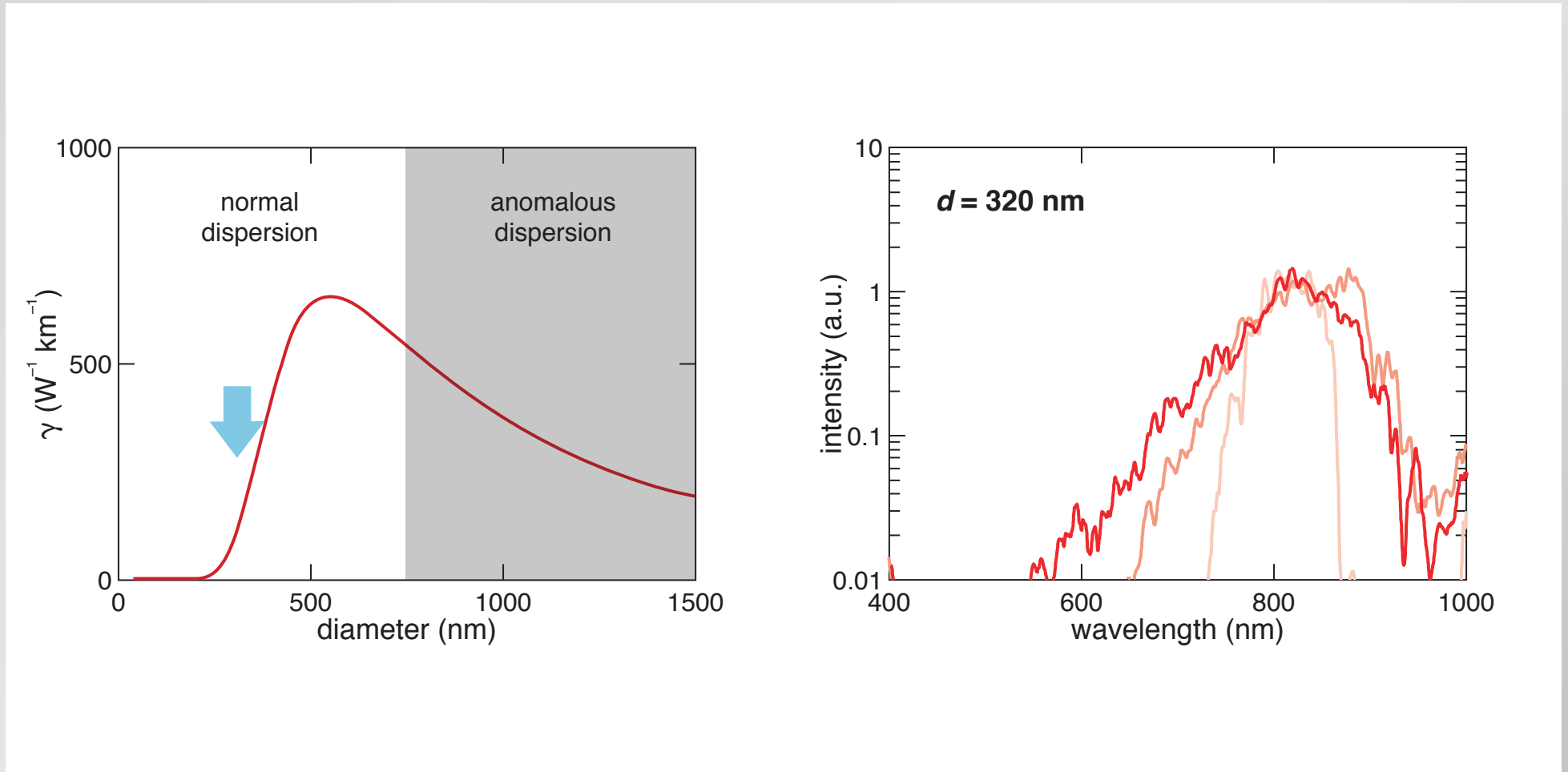

Nanoscale nonlinear optics

nanowire continuum generation

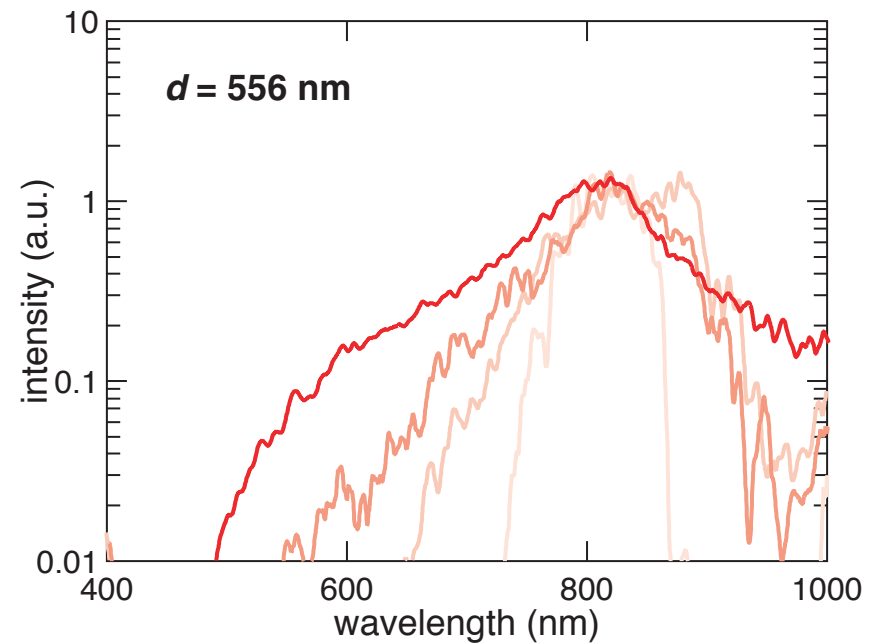
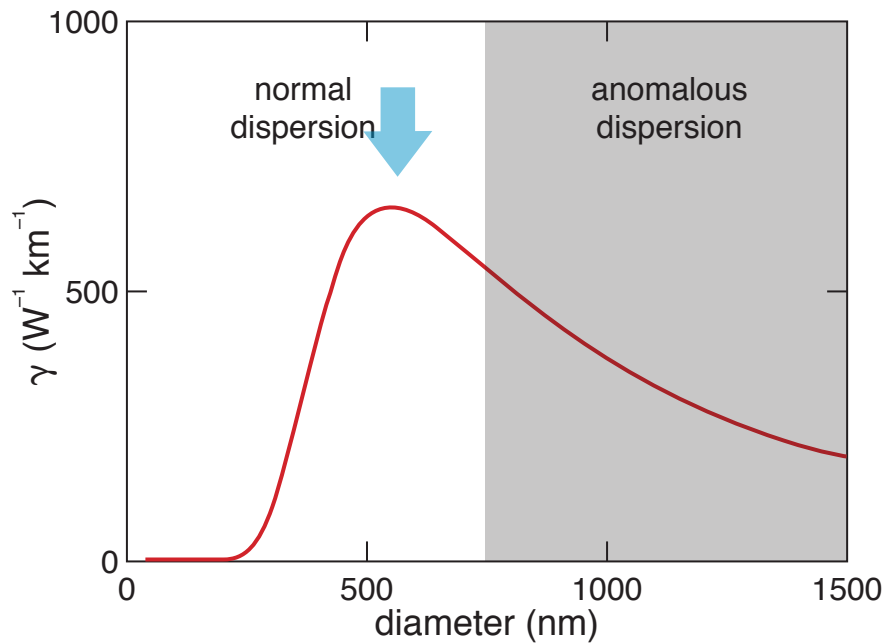

Nanoscale nonlinear optics

nanowire continuum generation

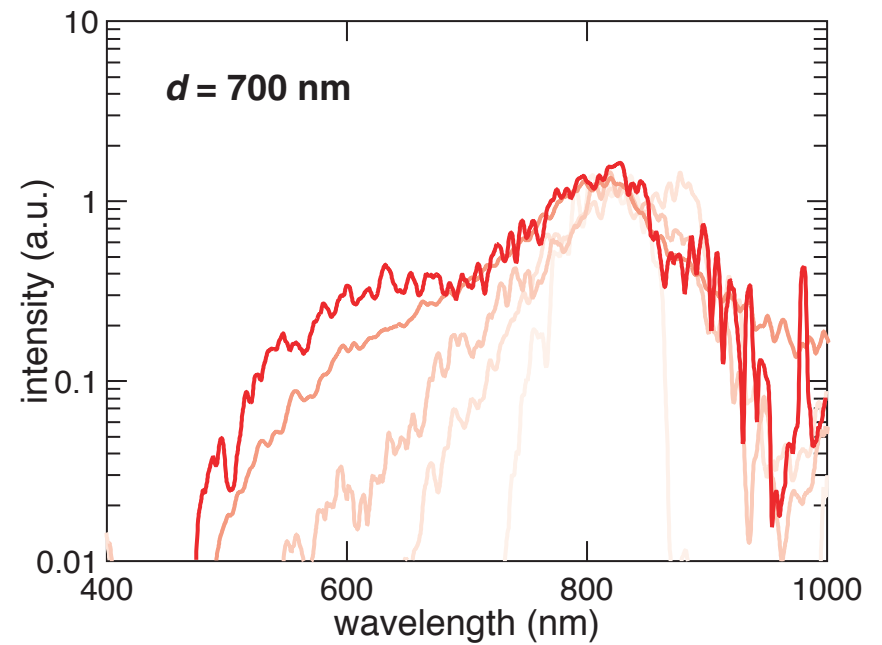
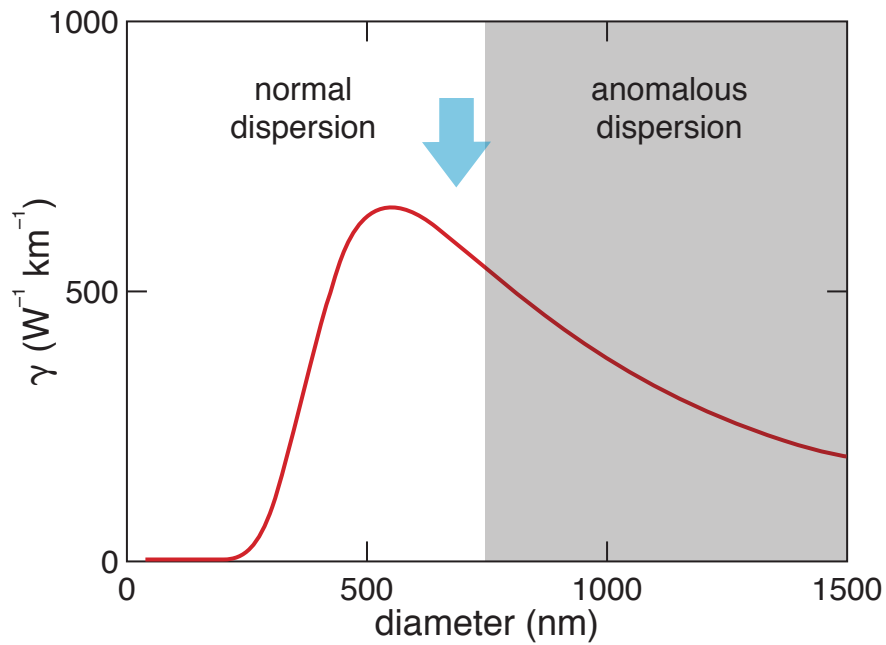

Nanoscale nonlinear optics

nanowire continuum generation

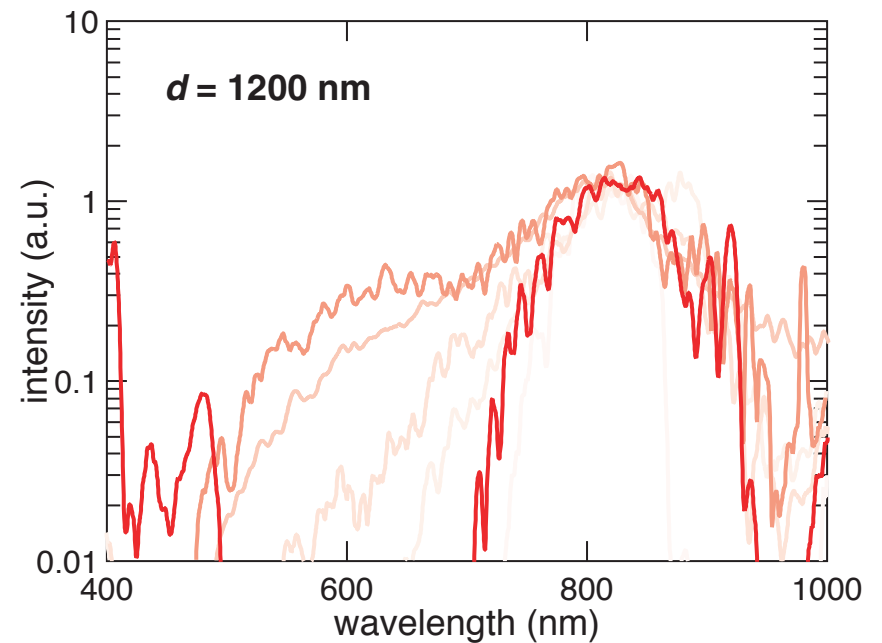
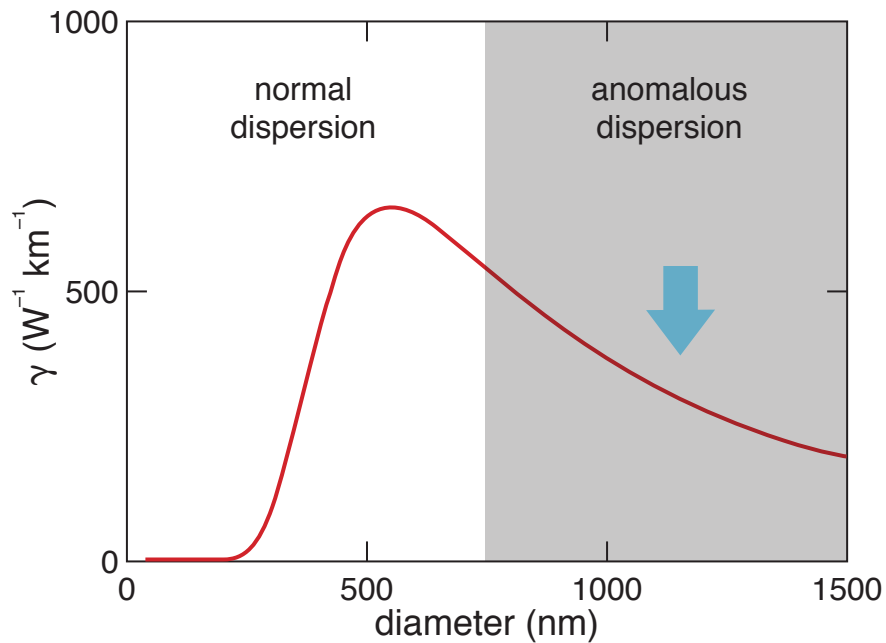

Nanoscale nonlinear optics

energy in nanowire < 100 pJ!

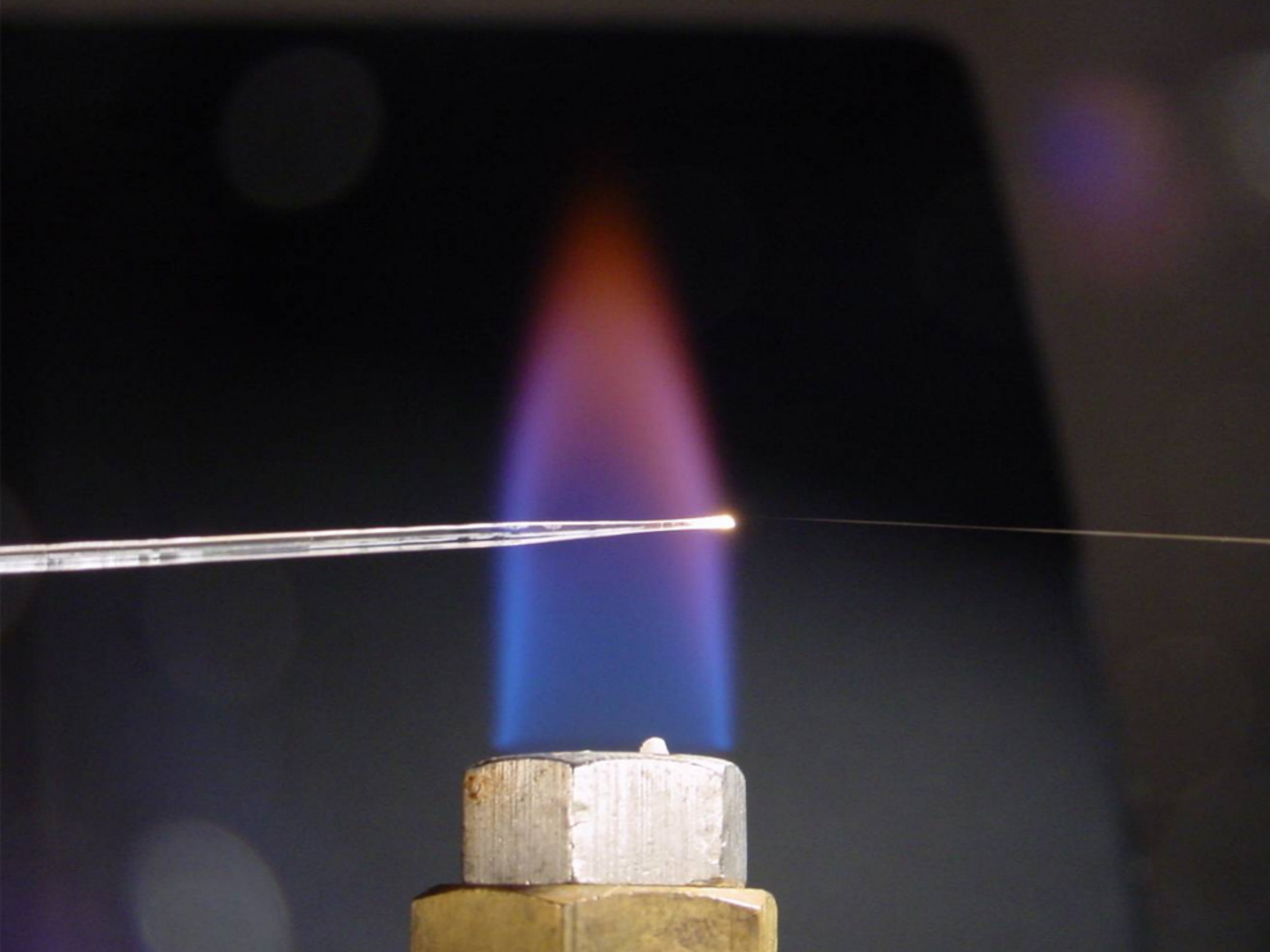

Summary

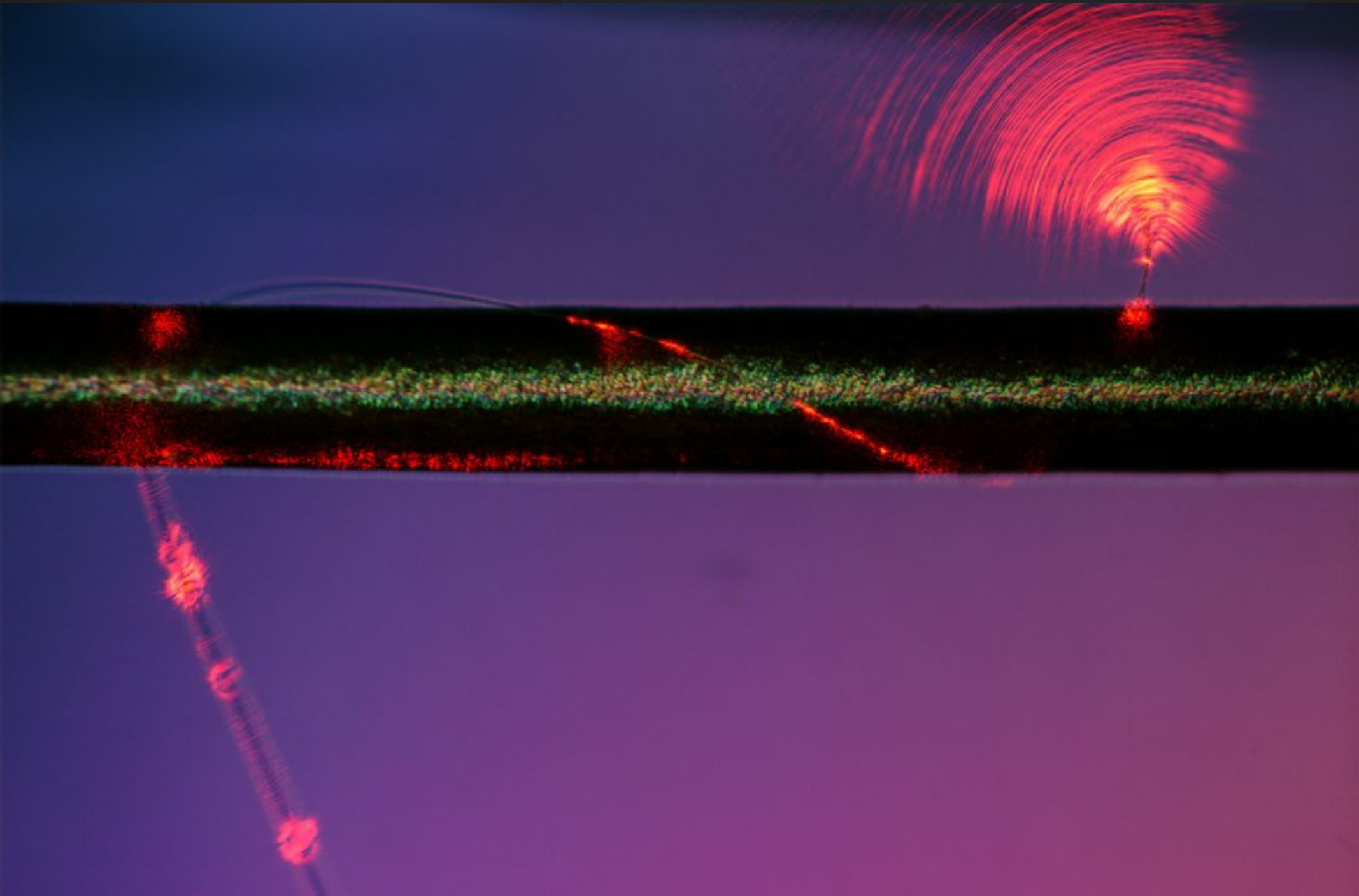

Summary

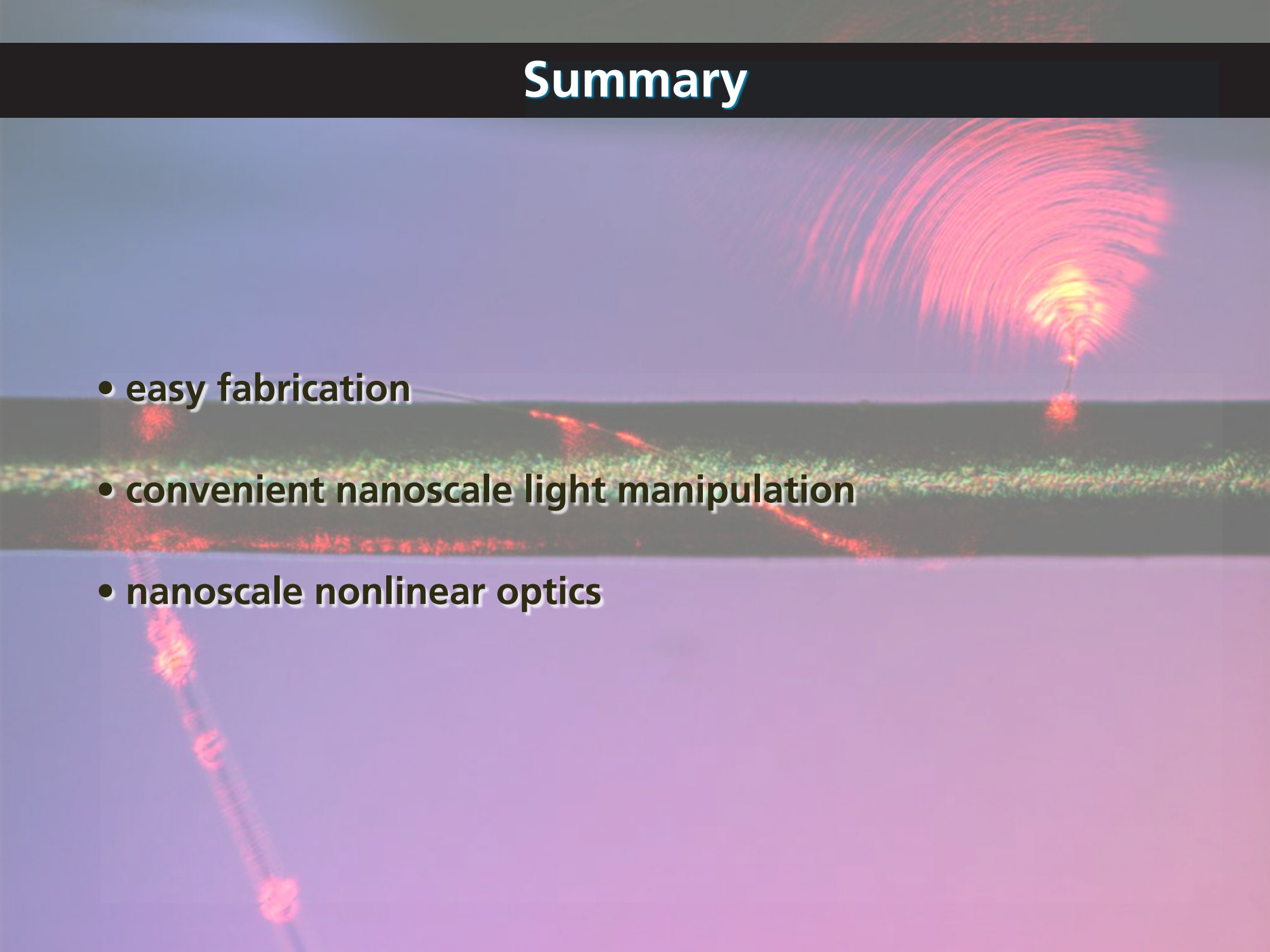
- **easy fabrication**
 - **convenient nanoscale light manipulation**
 - **nanoscale nonlinear optics**
- 



Funding:

**Harvard Center for Imaging and Mesoscopic Structures
National Science Foundation
National Natural Science Foundation of China**

for a copy of this presentation:

<http://mazur-www.harvard.edu>

Follow me!



eric_mazur

Google™

Google Search

I'm Feeling Lucky

Google™

mazur

Google Search

I'm Feeling Lucky

Google™

Google Search

I'm Feeling Lucky

Google™

Google Search

I'm Feeling Lucky

Funding:

**Harvard Center for Imaging and Mesoscopic Structures
National Science Foundation
National Natural Science Foundation of China**

for a copy of this presentation:

<http://mazur-www.harvard.edu>

Follow me!



eric_mazur