

Memorization or understanding: are we teaching the right thing?

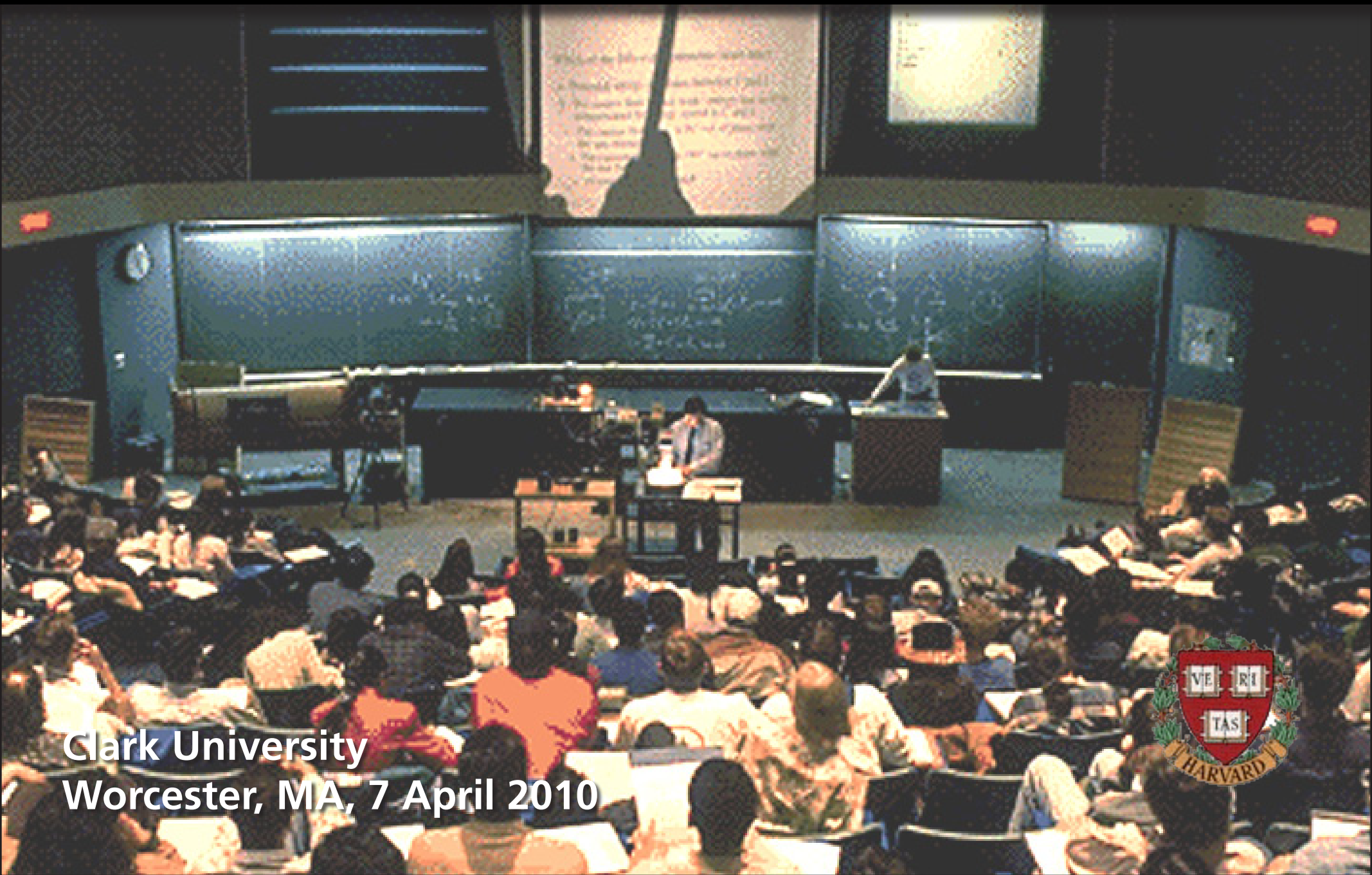

Clark University
Worcester, MA, 7 April 2010



My message

shift focus from "teaching" to helping students learn



Outline

- Education



Outline

- Education

- Peer Instruction

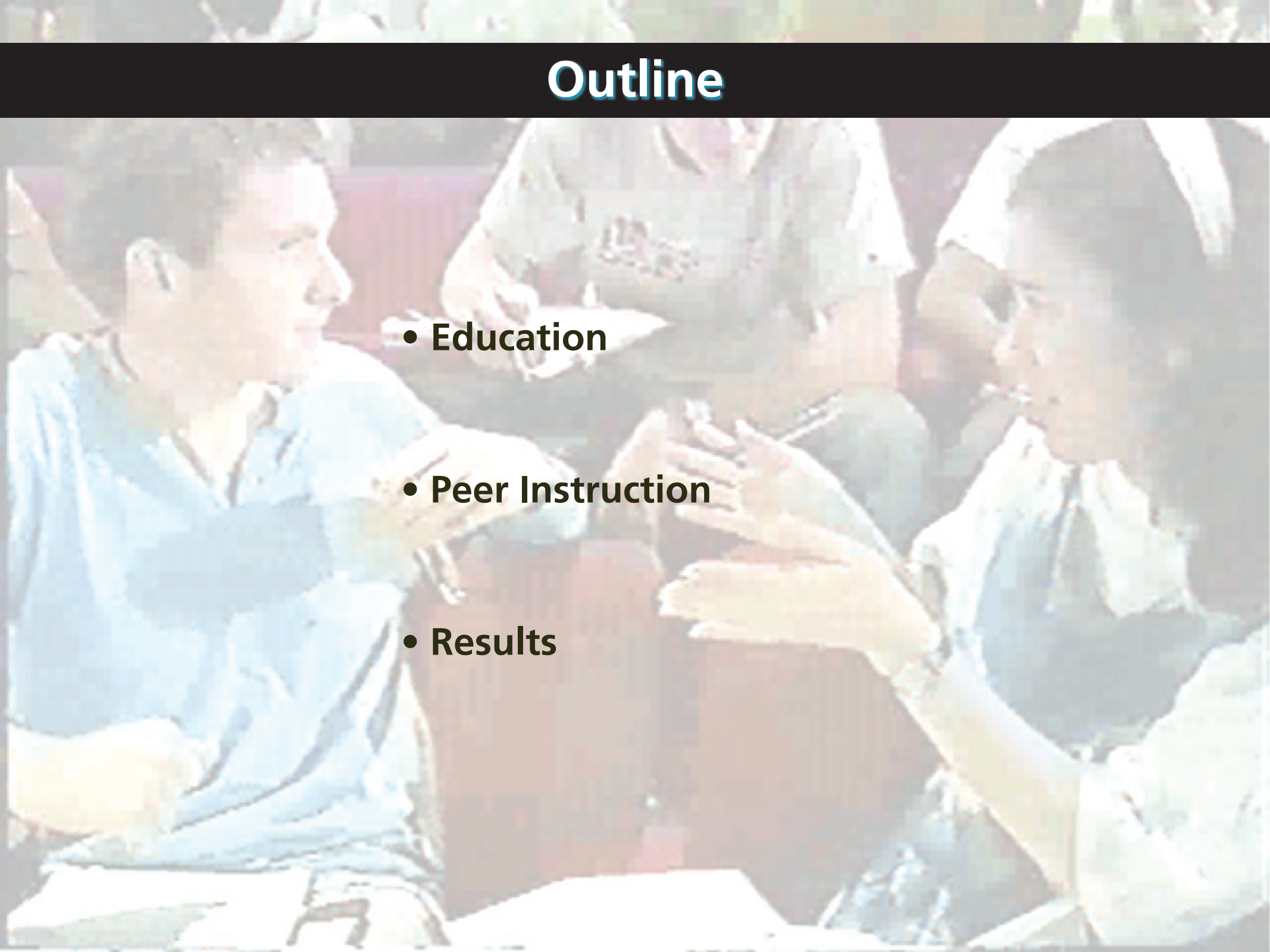

Outline

- Education
 - Peer Instruction
 - Results
- 

Education



Education

lectures focus on delivery of information

A wide-angle photograph of a large lecture hall. At the front of the room, a lecturer stands behind a podium, addressing the audience. The room is filled with students seated at long desks, many of whom are looking towards the front. The walls are dark, and there are large windows or screens at the front. The overall atmosphere is that of a formal educational setting.

Education

education is not just information transfer

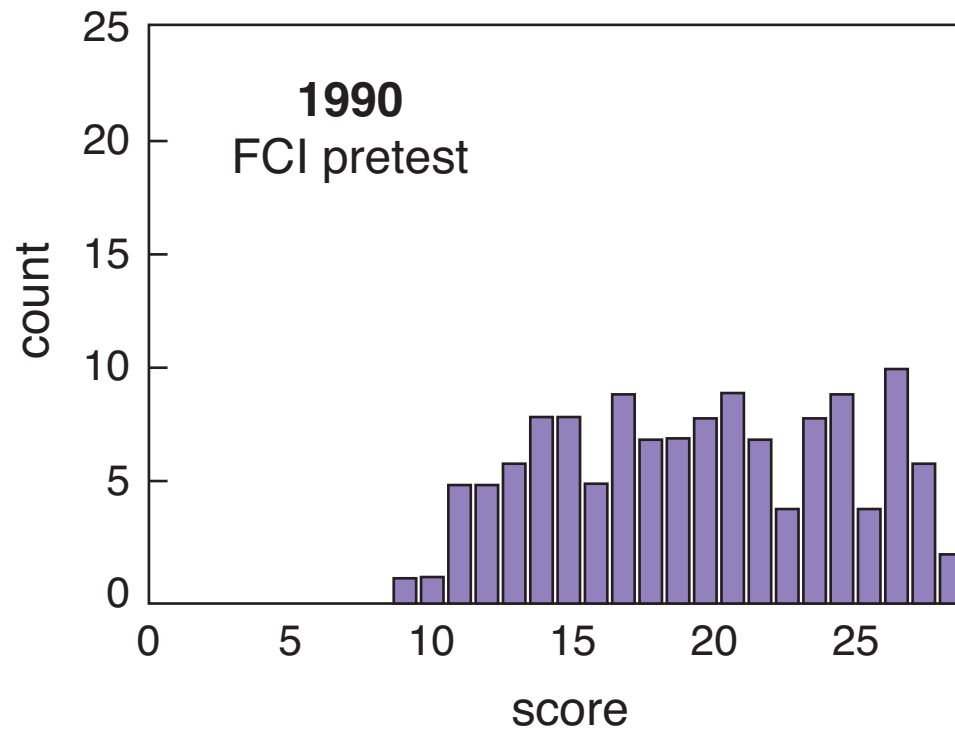

Education

education is not just information transfer

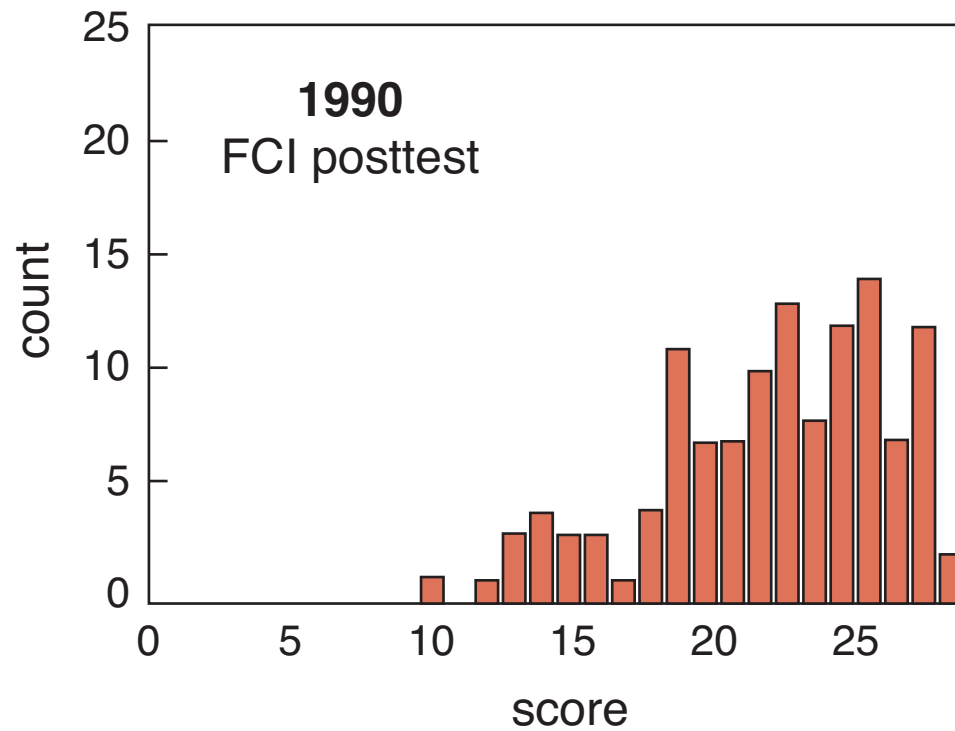

Education

education is not just information transfer

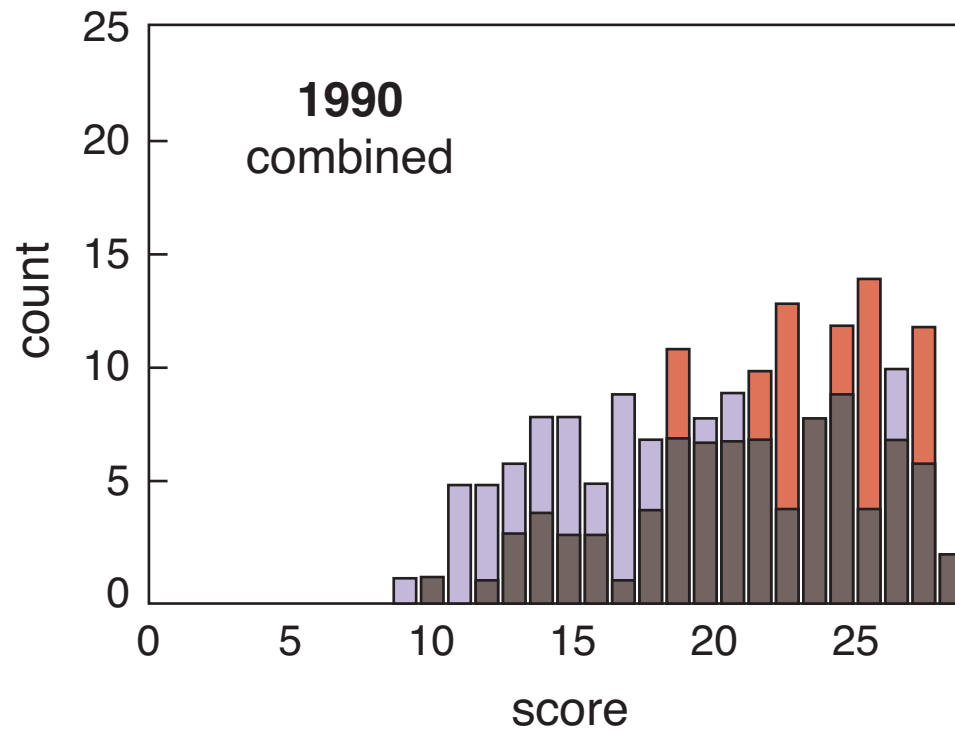

Education

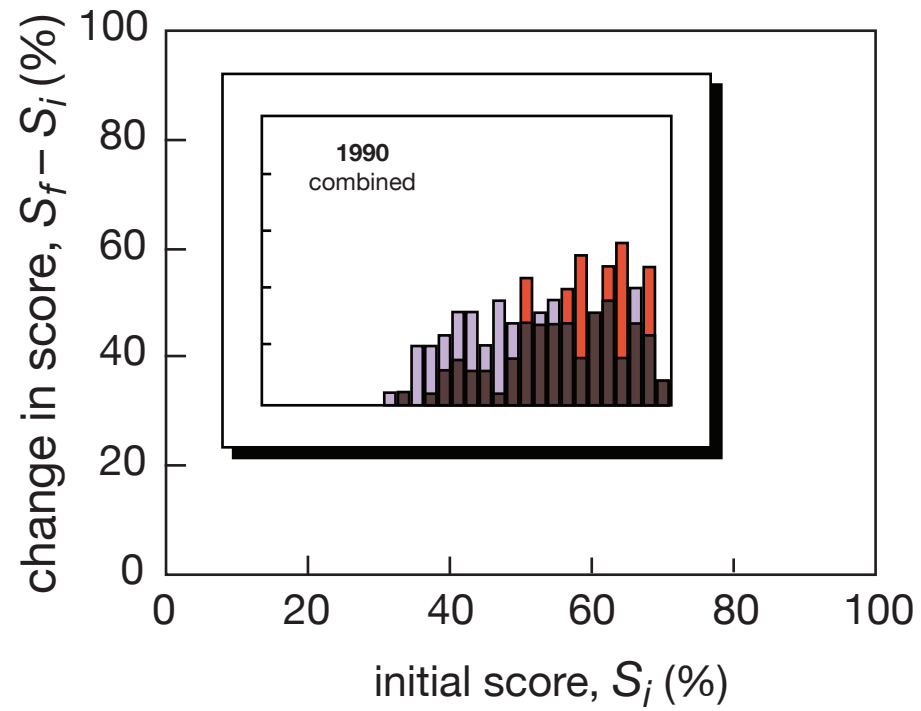

Education

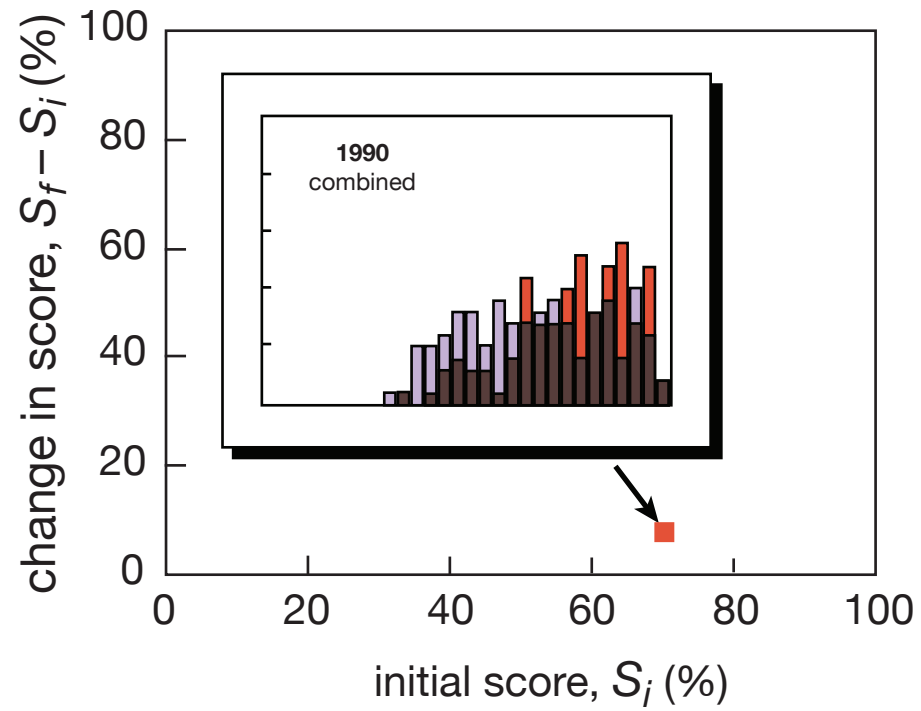

Education

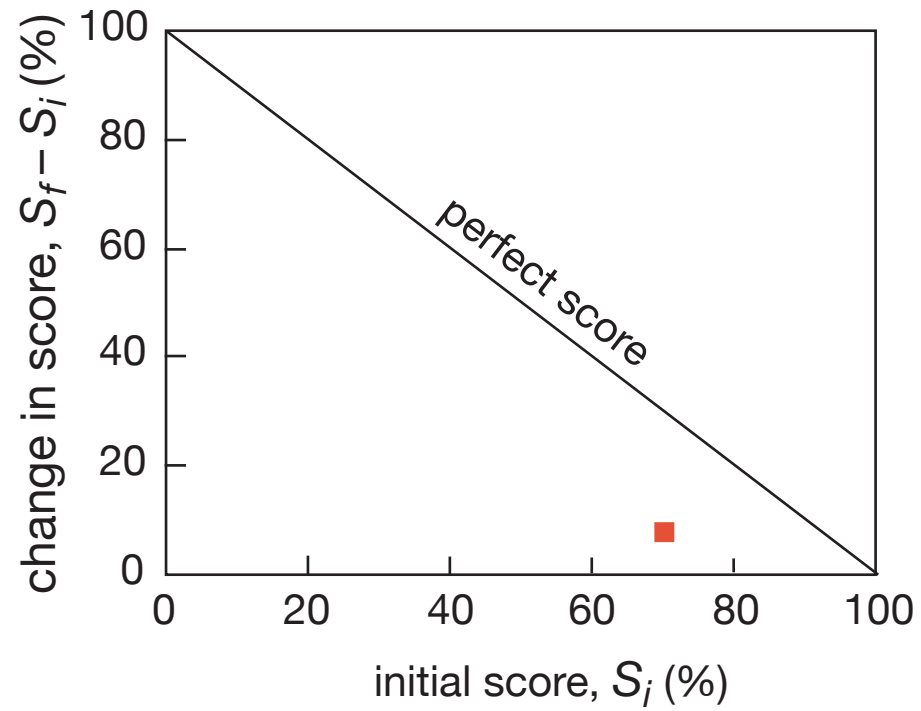

Education

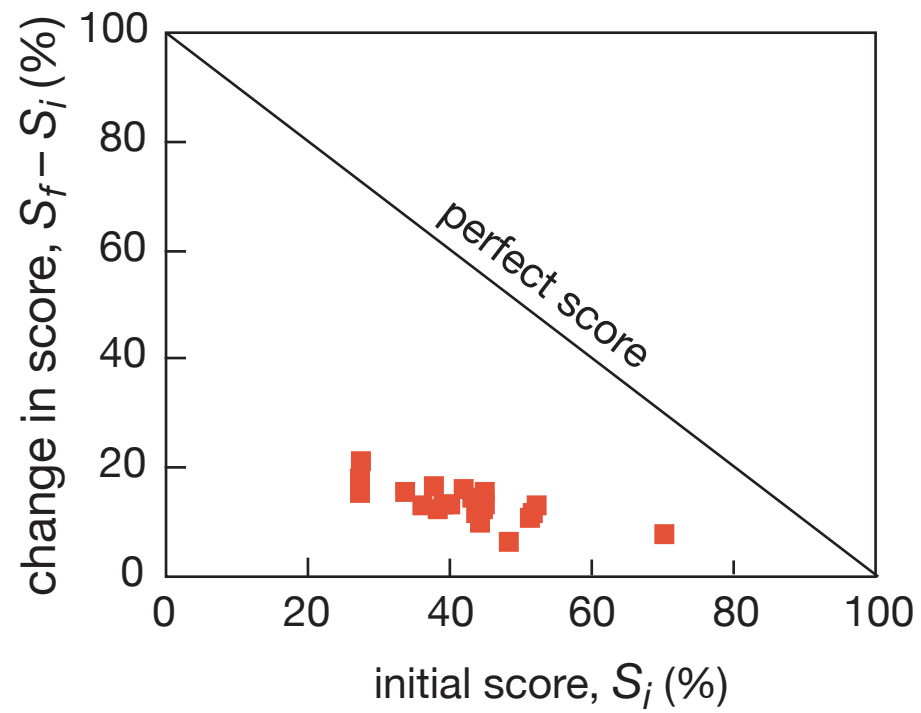

Education

only one quarter of maximum gain realized

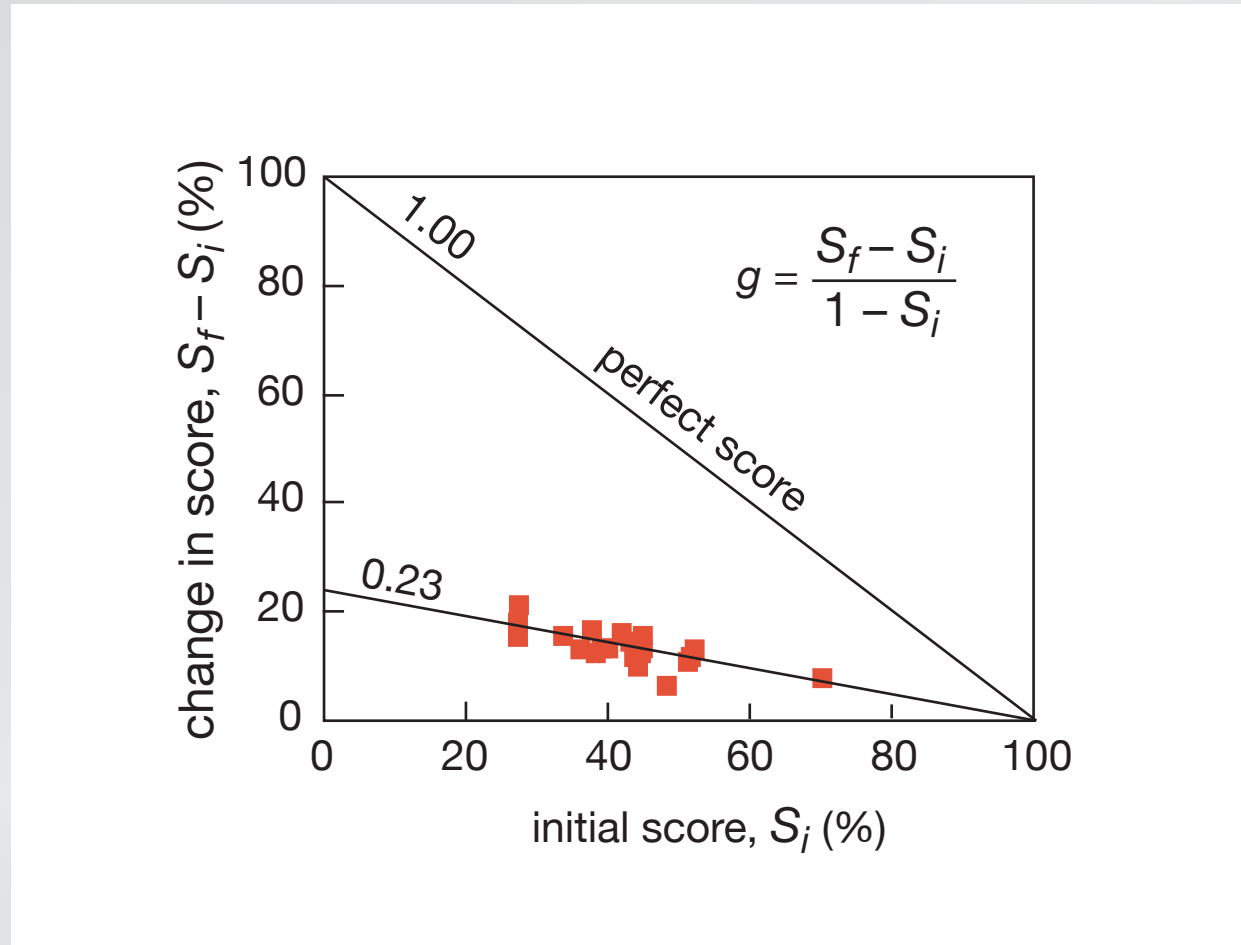

Education

not transfer but assimilation of information is key

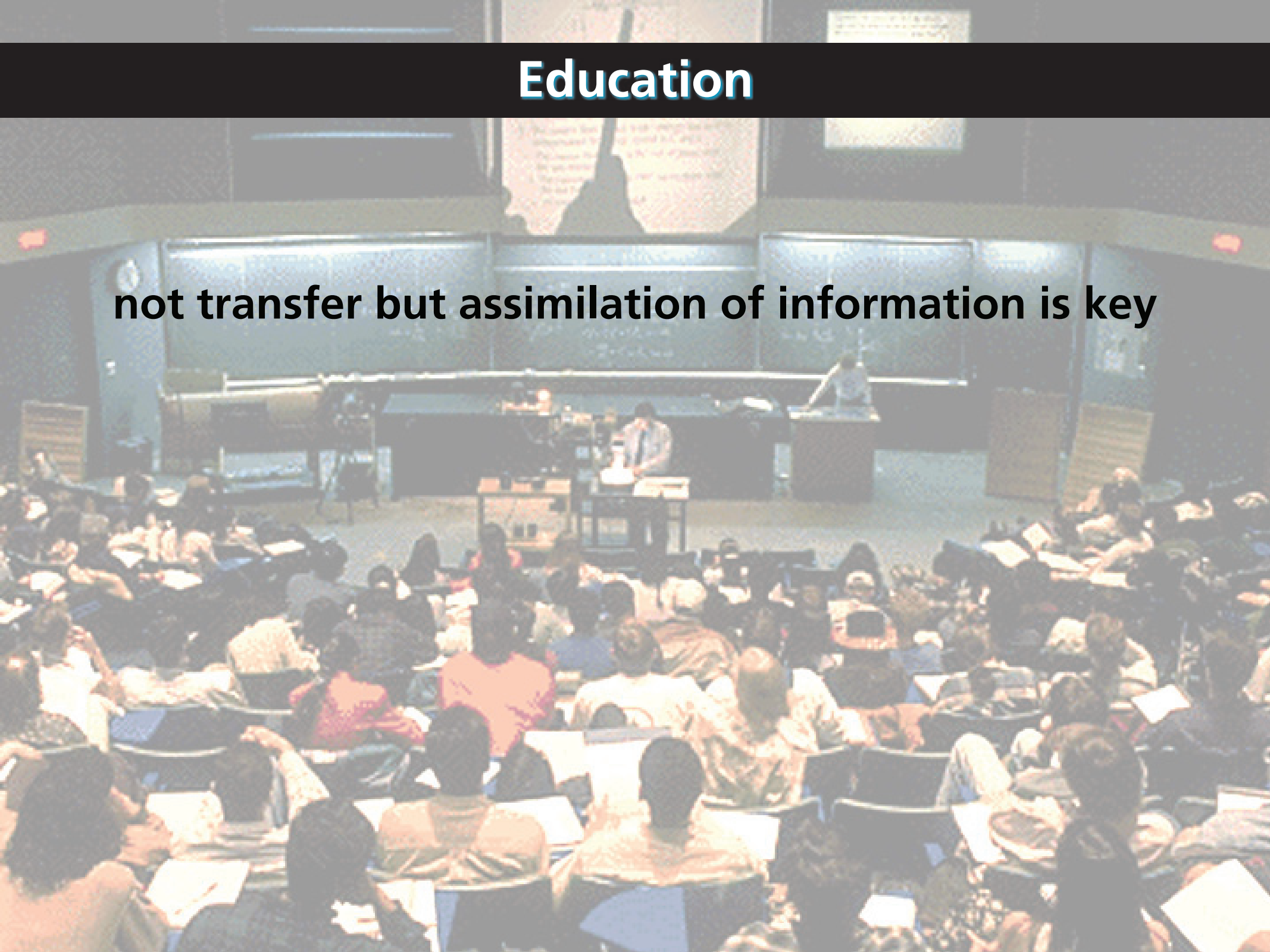

Education

conventional problems misleading

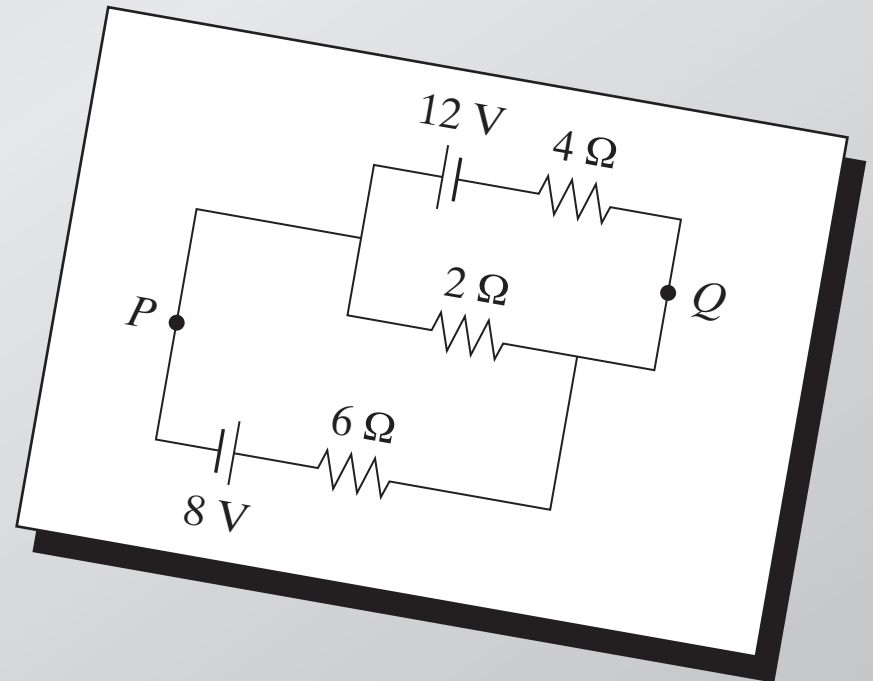

Education

conventional problems misleading

Calculate:

(a) current in $2\text{-}\Omega$ resistor

(b) potential difference

between P and Q

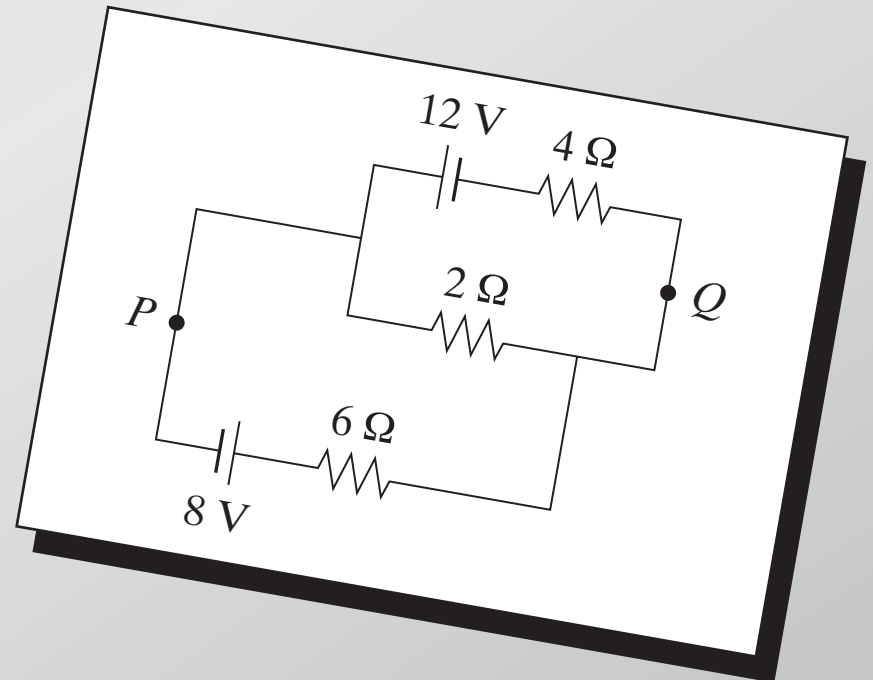

Education

are the basic principles understood?

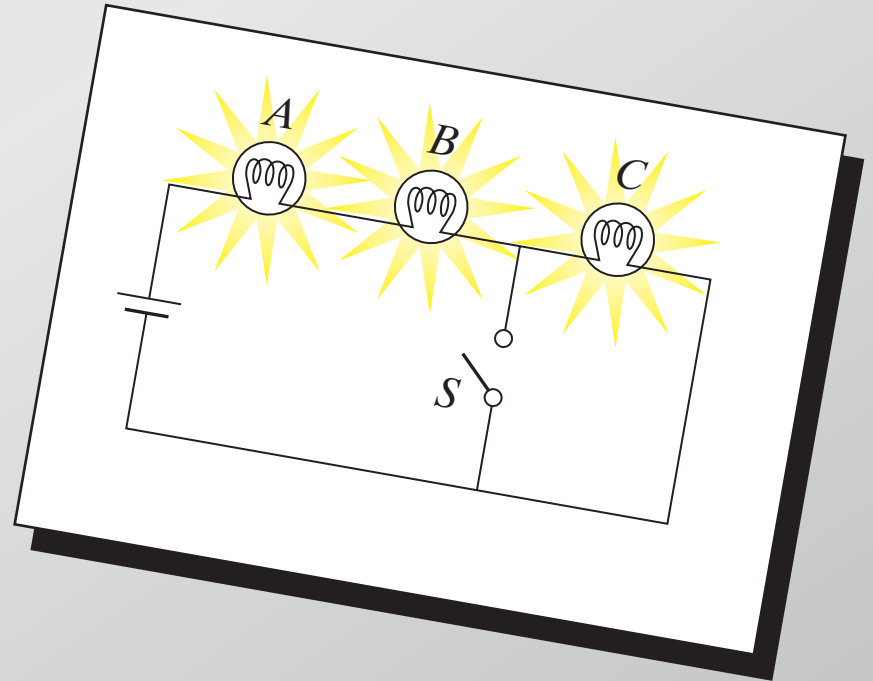

Education

are the basic principles understood?

When S is closed, what happens to:

- (a) intensities of A and B ?
- (b) intensity of C ?
- (c) current through battery?
- (d) potential difference across
 A , B , and C ?
- (e) the total power dissipated?

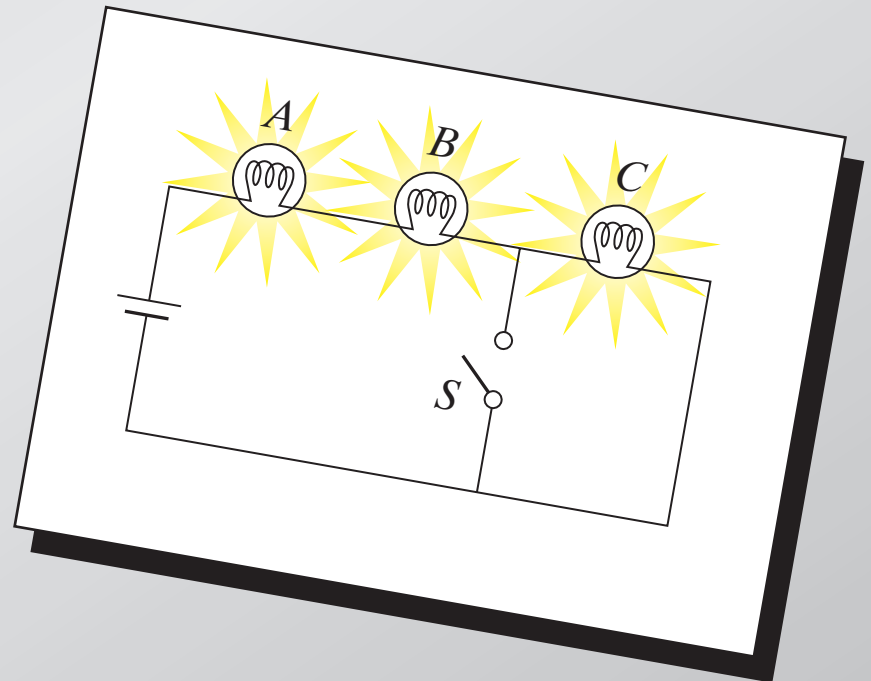

Education

conventional

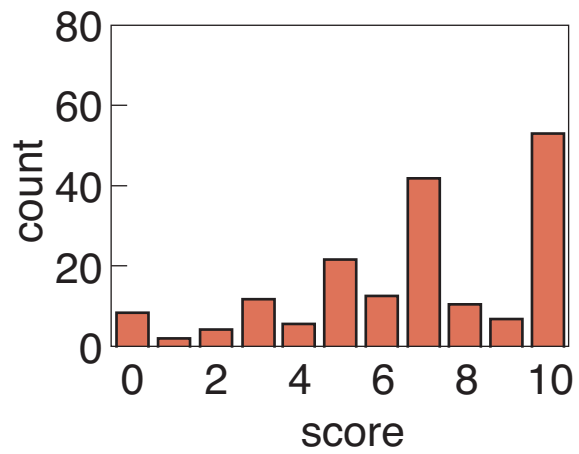

conceptual

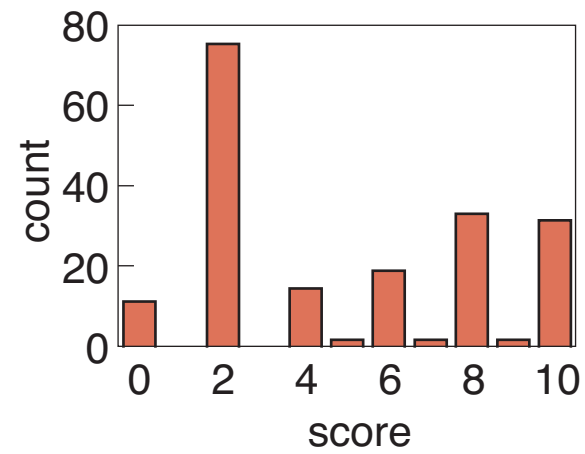

Education

conventional

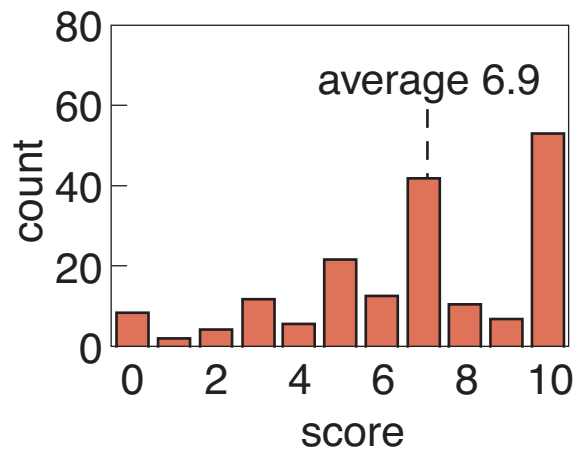

conceptual

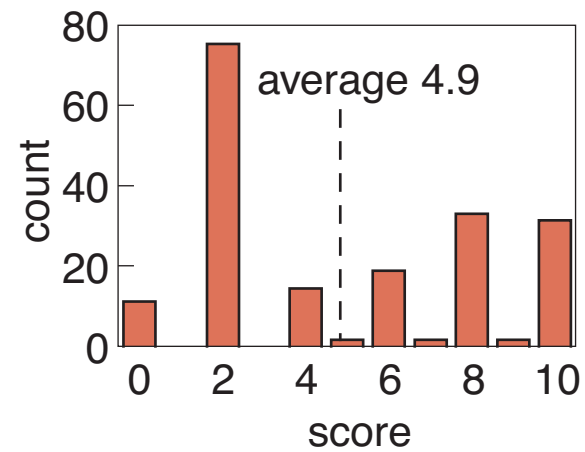

Education

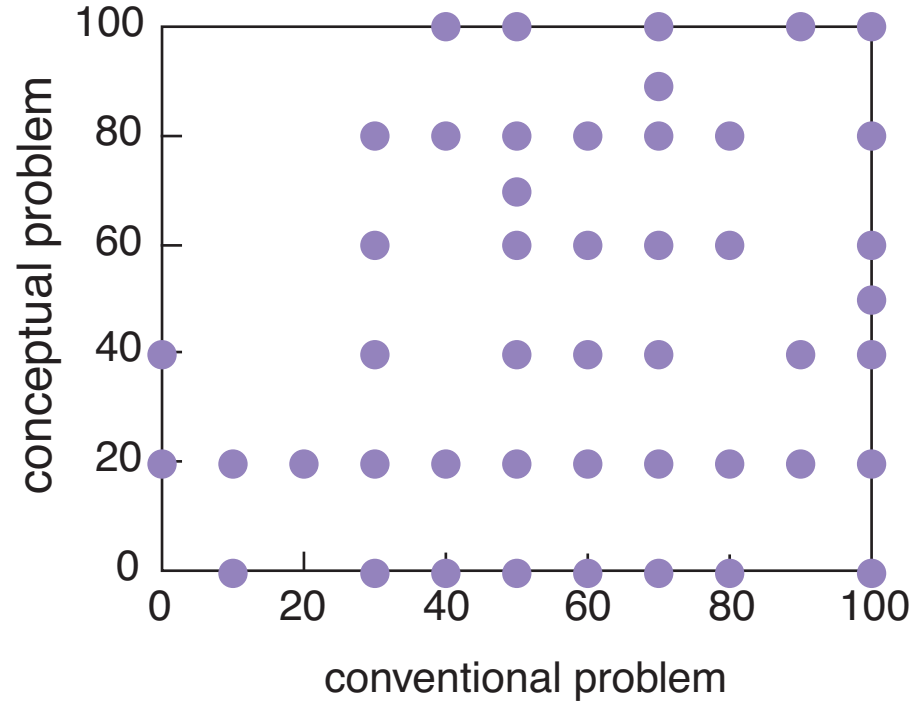

Education

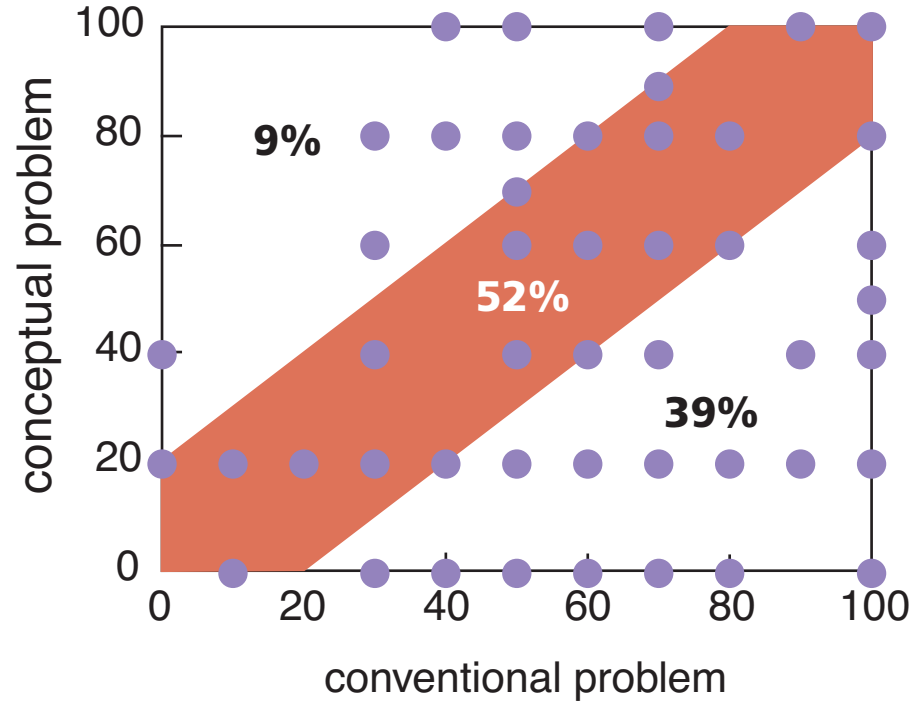

A large lecture hall with students seated at desks, facing a stage with a lecturer and a large screen displaying text. The text on the screen is partially legible and appears to be a list or a set of instructions. The room is dimly lit, with the stage area being the primary source of light. The students are mostly seen from the back, and many have papers or books open on their desks. The lecturer is standing at a podium on the stage, facing the audience. The overall atmosphere is that of a formal academic setting.

So what should we do?

Peer Instruction

Give students more responsibility for gathering information...

Peer Instruction

**Give students more responsibility for gathering information...
so we can better help them assimilate it.**

Peer Instruction

Main features:

- pre-class reading
- in-class: depth, not 'coverage'
- ConcepTests

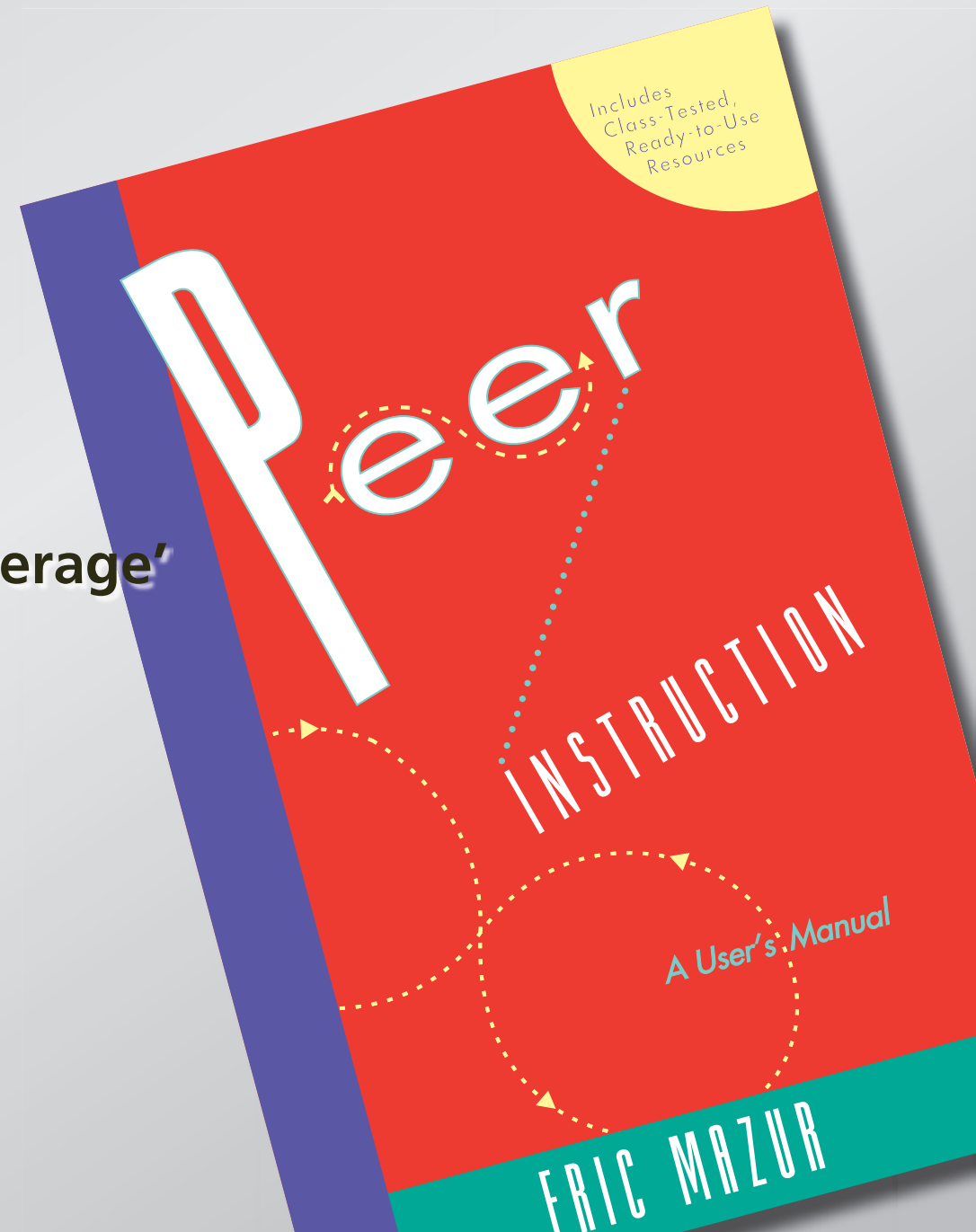

Peer Instruction

ConcepTest:

- 1. Question**
- 2. Thinking**
- 3. Individual answer**
- 4. Peer discussion**
- 5. Revised/Group answer**
- 6. Explanation**

Results

is it any good?

Results

first year of implementing PI

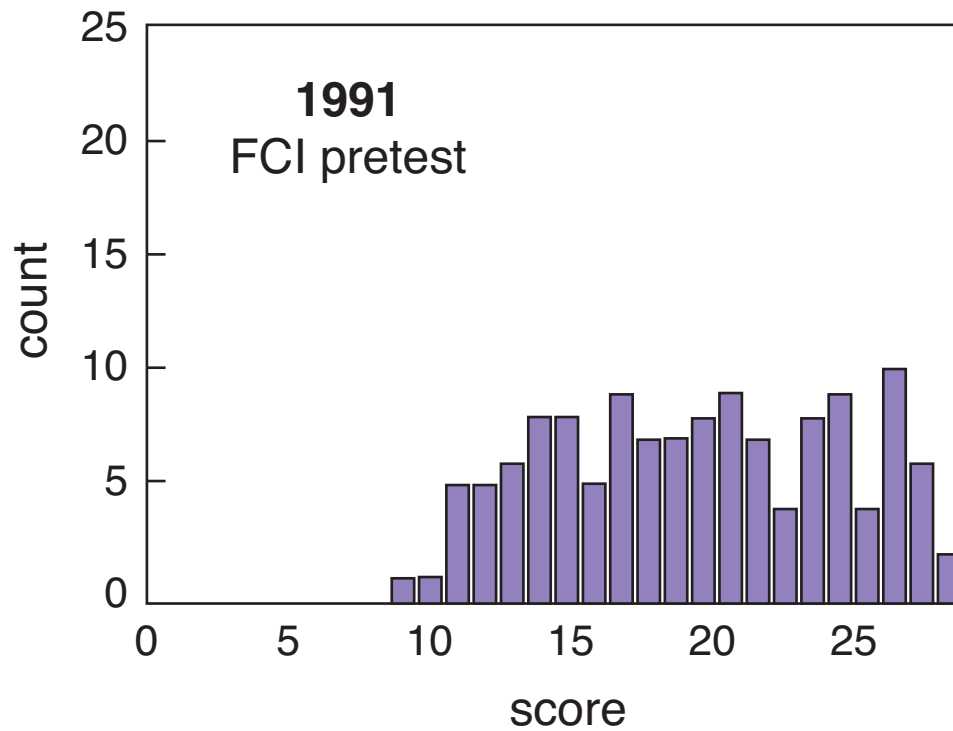

Results

first year of implementing PI

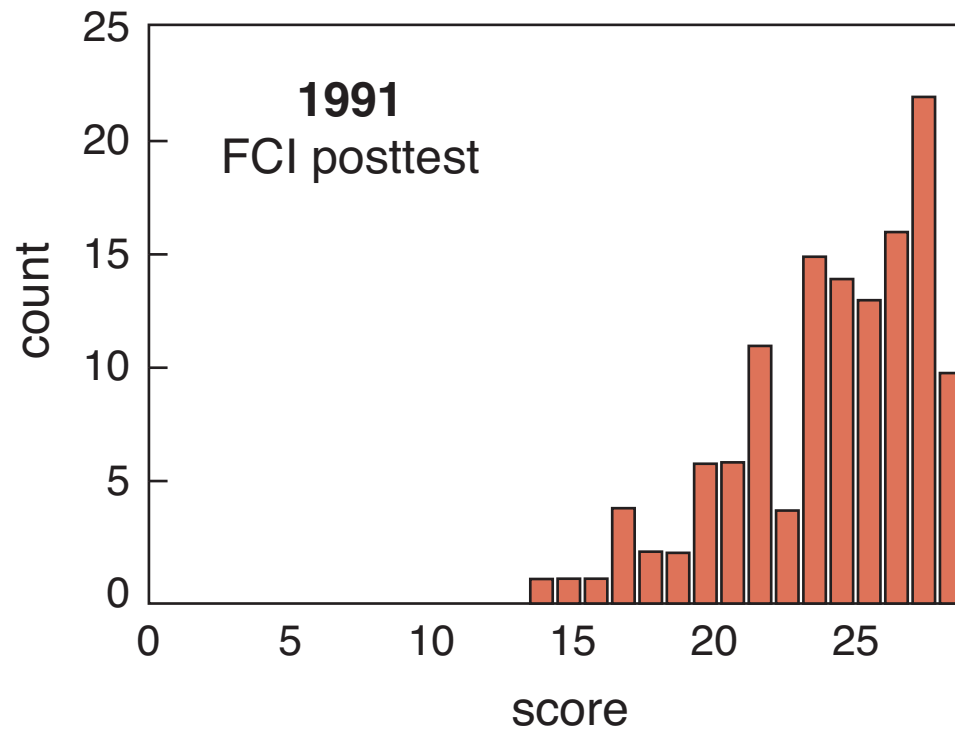

Results

first year of implementing PI

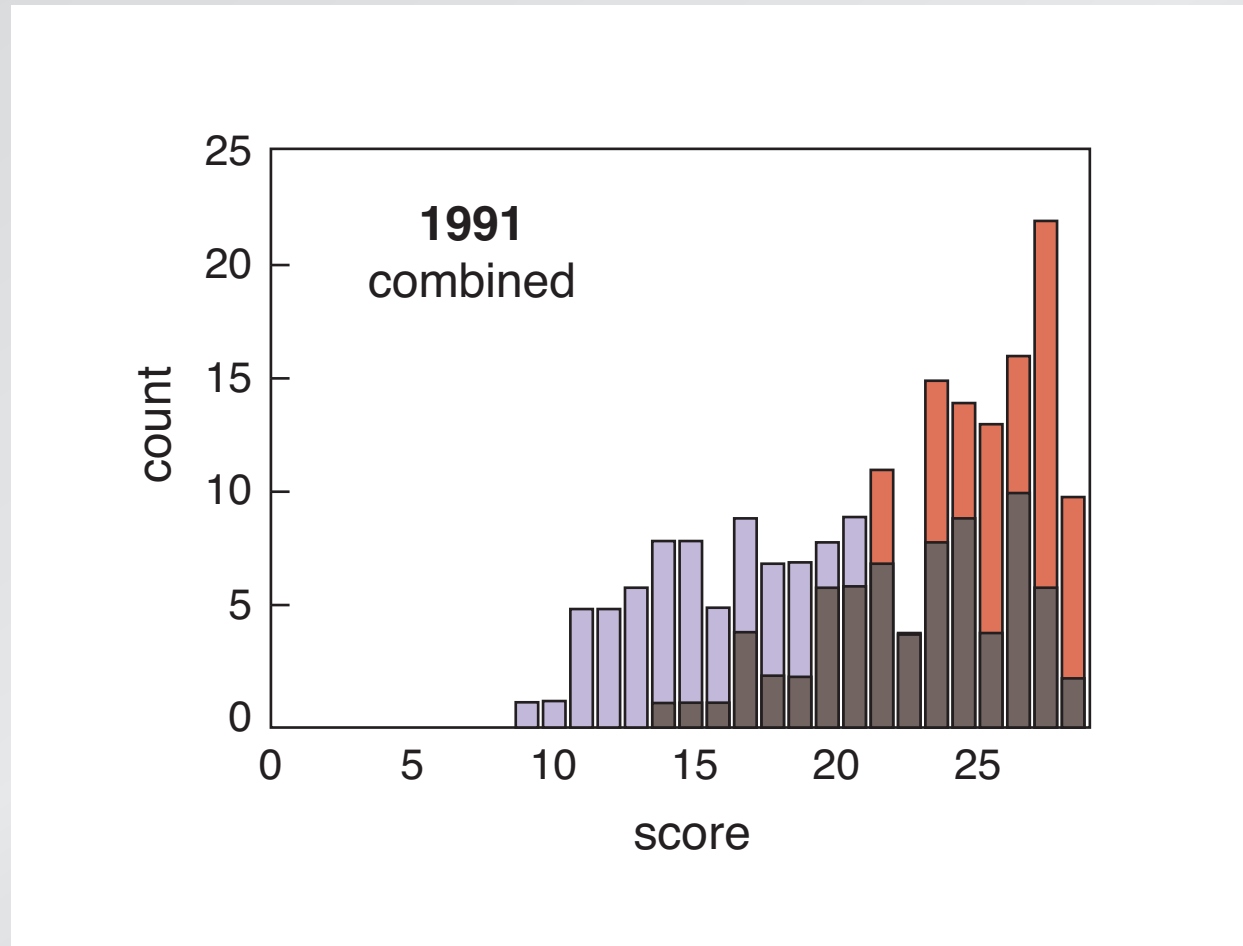

Results

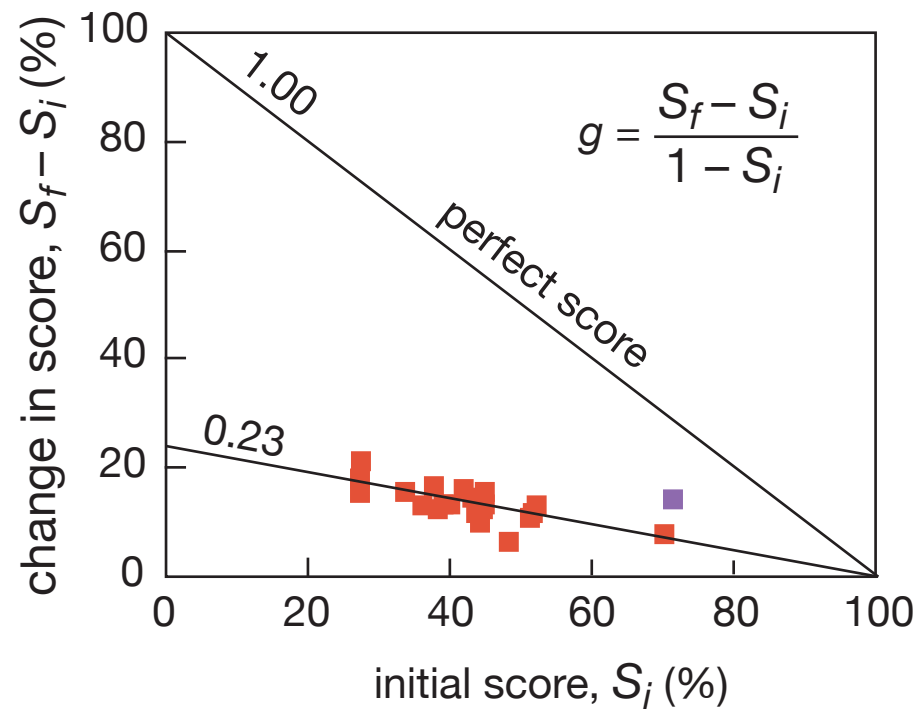

Results

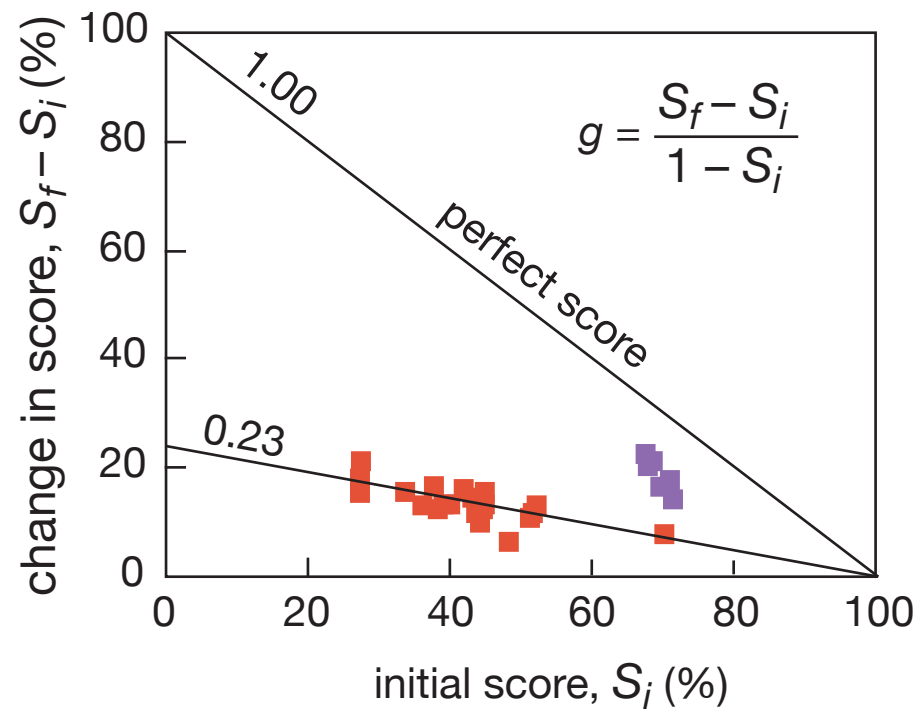

Results

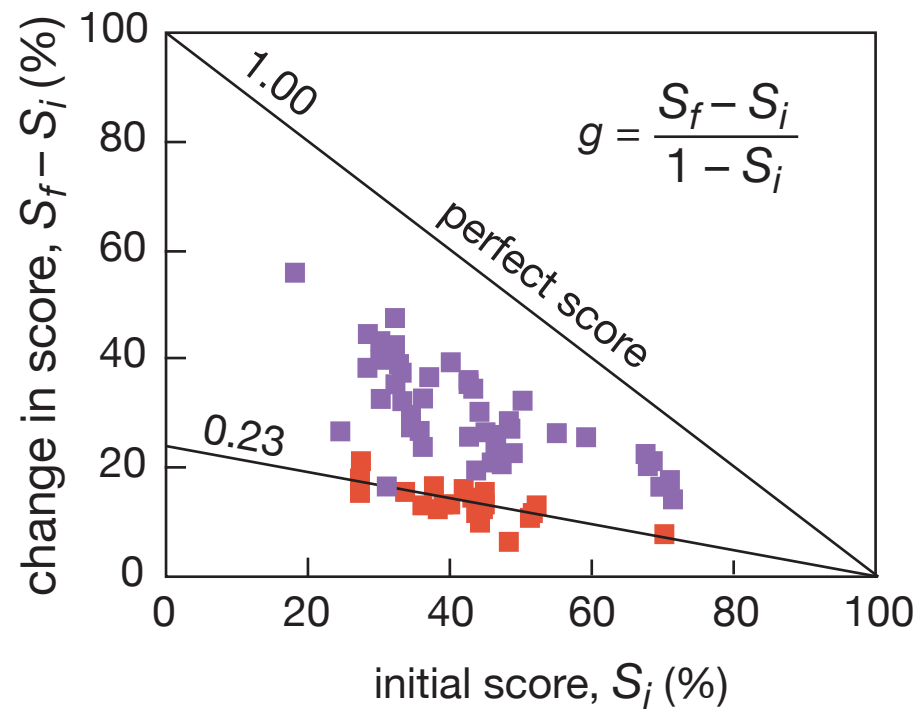

Results

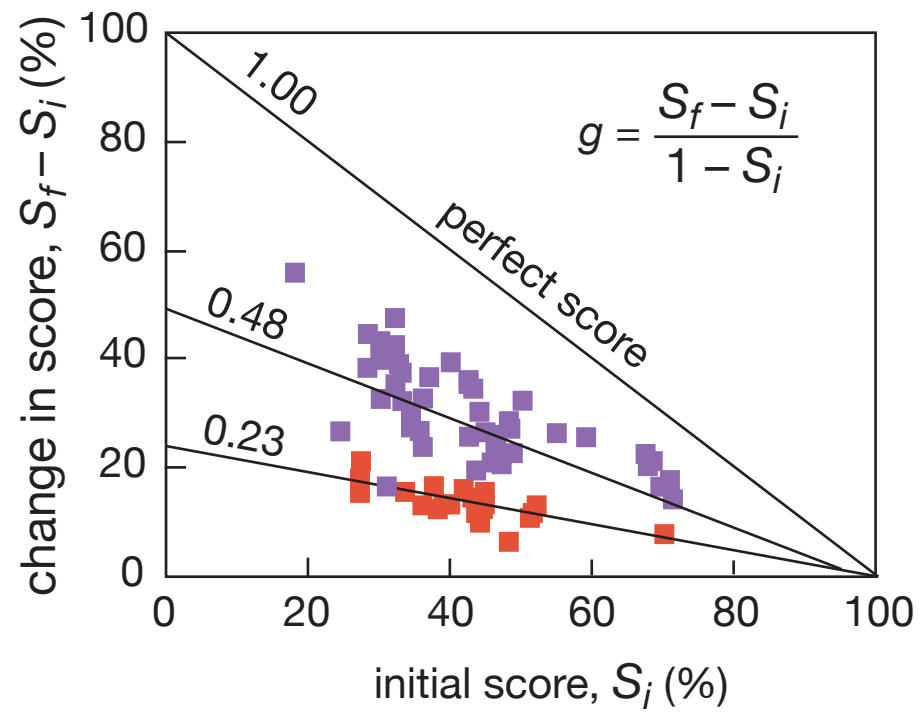

Results

what about problem solving?

Results

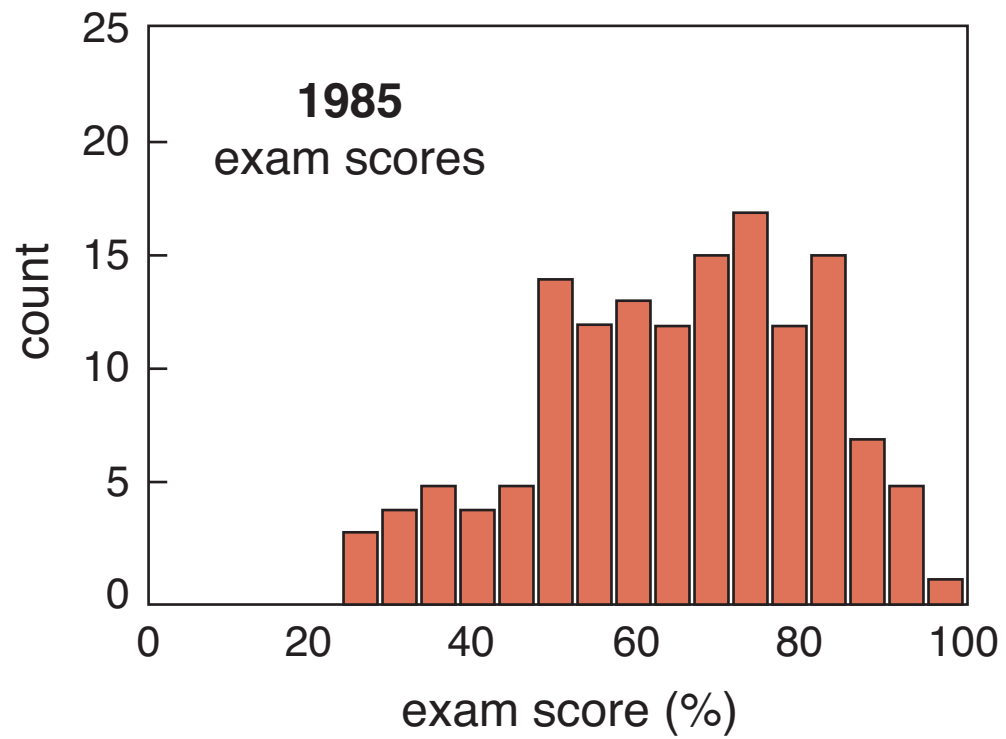

Results

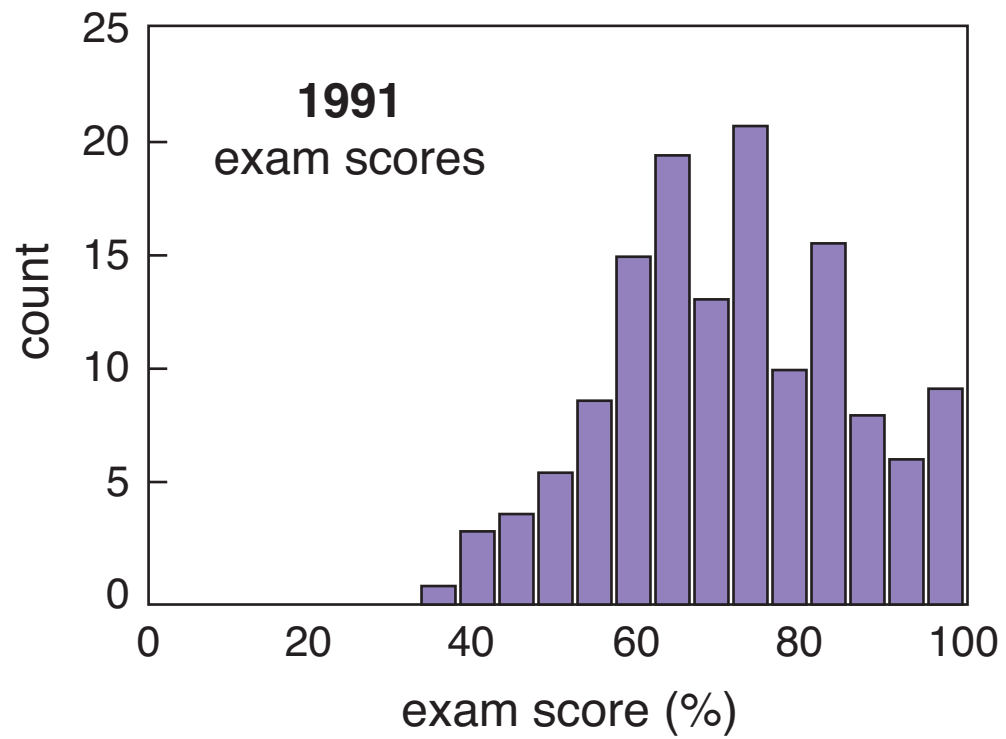

Results

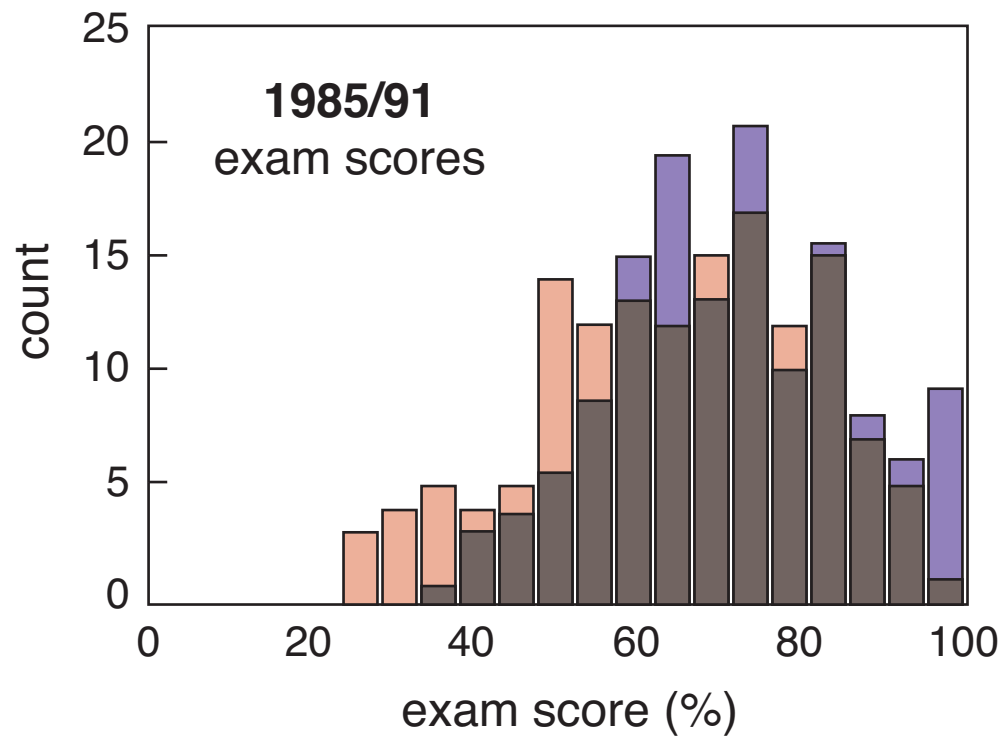

Conclusion

**So better understanding leads to better
problem solving!**

Conclusion

So better understanding leads to better problem solving!

(but “good” problem solving doesn’t always indicate understanding!)

Why does it work?

Students:

- promotes thinking
- helps uncover and address misunderstanding
- boosts confidence

Why does it work?

Students:

- promotes thinking
- helps uncover and address misunderstanding
- boosts confidence

Faculty:

- change of format, not content
- with existing questions, little effort
- adaptable

Summary

Traditional indicators of success misleading

Summary

Traditional indicators of success misleading

Education is no longer about information

Funding:

National Science Foundation

for a copy of this presentation:

<http://mazur-www.harvard.edu>

Follow me!



eric_mazur

Google™

Google Search

I'm Feeling Lucky

Google™

mazur

Google Search

I'm Feeling Lucky

Google™

mazur

Google Search

I'm Feeling Lucky

Google™

Google Search

I'm Feeling Lucky

Funding:

National Science Foundation

for a copy of this presentation:

<http://mazor-www.harvard.edu>

Follow me!



eric_mazor