

Black silicon: Engineering an intermediate band for optical sensing



National Renewable Energy Laboratory
Golden, CO, 15 October 2010





Mark Winkler



Renee Sher

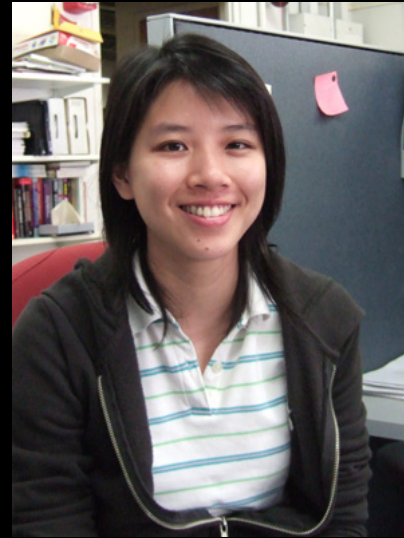

Yu-Ting Lin



Eric Mazur

and also....

**Eric Diebold
Haifei Albert Zhang
Dr. Brian Tull
Dr. Jim Carey
Prof. Tsing-Hua Her
Dr. Shrenik Deliwala
Dr. Richard Finlay
Dr. Michael Sheehy
Dr. Claudia Wu
Dr. Rebecca Younkin
Prof. Catherine Crouch
Prof. Mengyan Shen
Prof. Li Zhao**

**Dr. John Chervinsky
Dr. Joshua Levinson**

**Prof. Michael Aziz
Prof. Cynthia Friend
Prof. Howard Stone**

**Prof. Tonio Buonassisi (MIT)
Prof. Silvija Gradecak (MIT)
Dr. Bonna Newman (MIT)
Joe Sullivan (MIT)**

Prof. Augustinus Asenbaum (Vienna)

**Dr. François Génin (LLNL)
Mark Wall (LLNL)**

**Dr. Richard Farrell (RMD)
Dr. Arie Karger (RMD)
Dr. Richard Meyers (RMD)**

Dr. Pat Maloney (NVSED)

Dr. Jeffrey Warrander (ARDEC)

Introduction

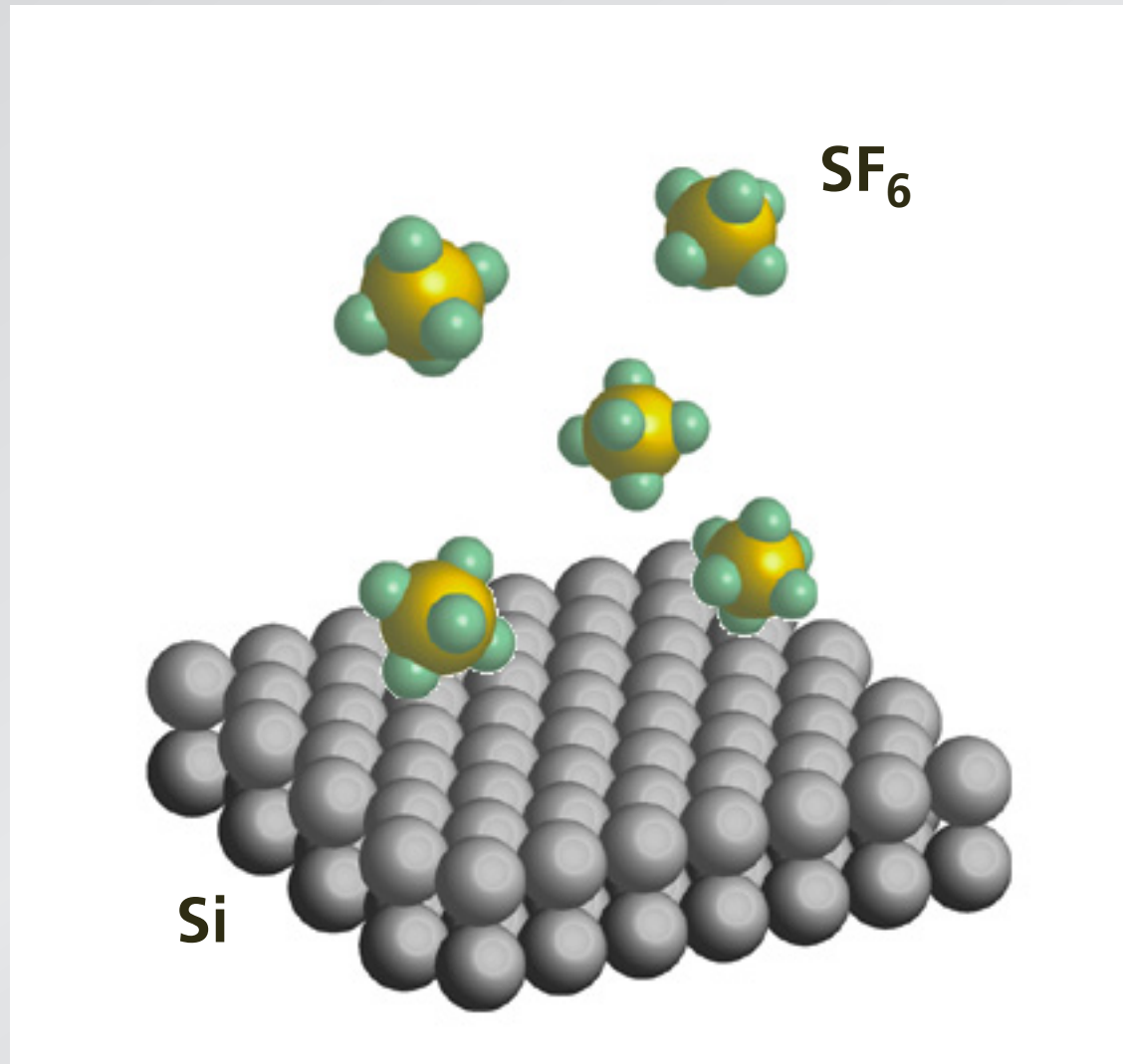

irradiate with 100-fs 10 kJ/m^2 pulses

Introduction

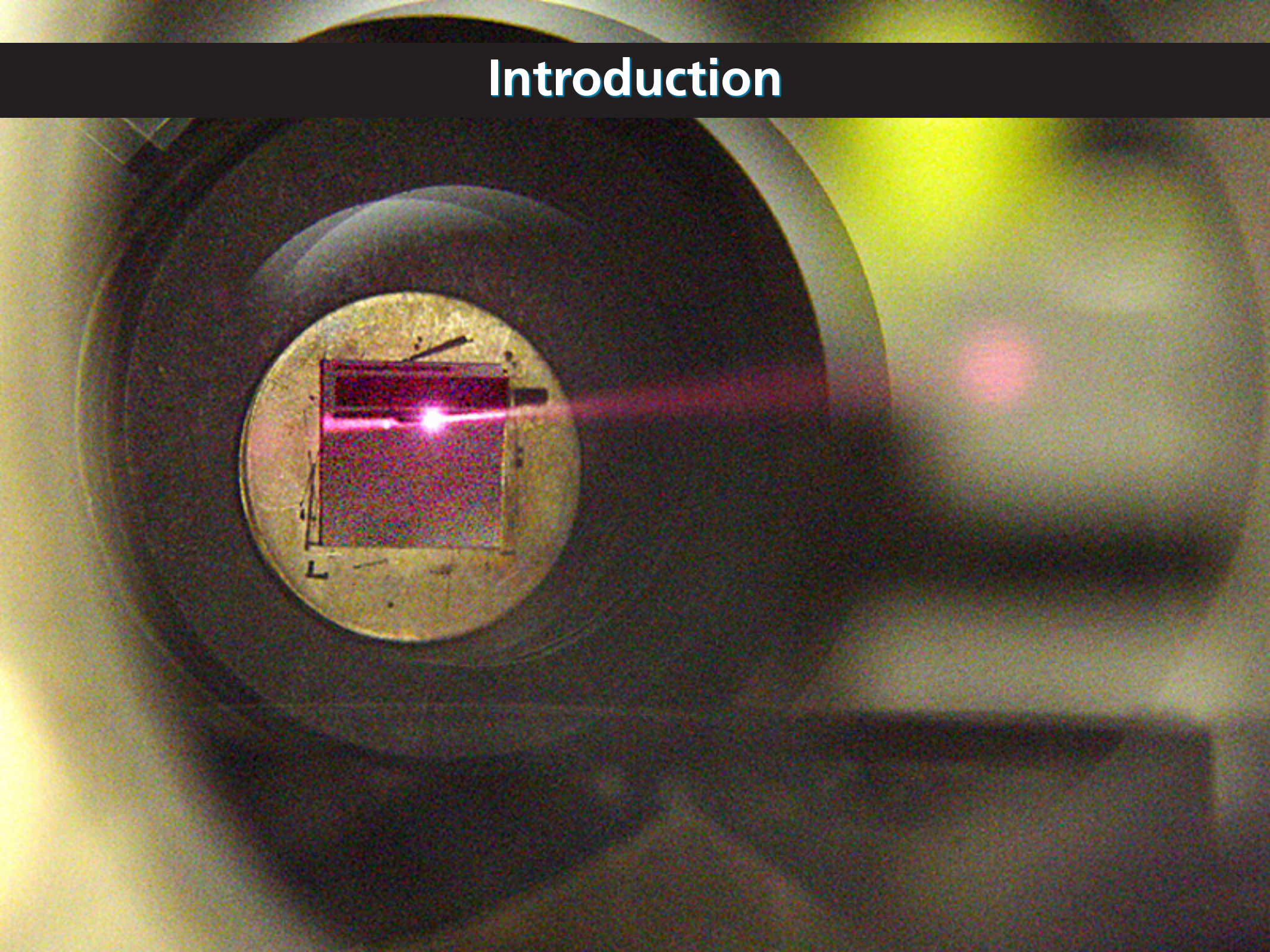

Introduction



"black silicon"

Introduction

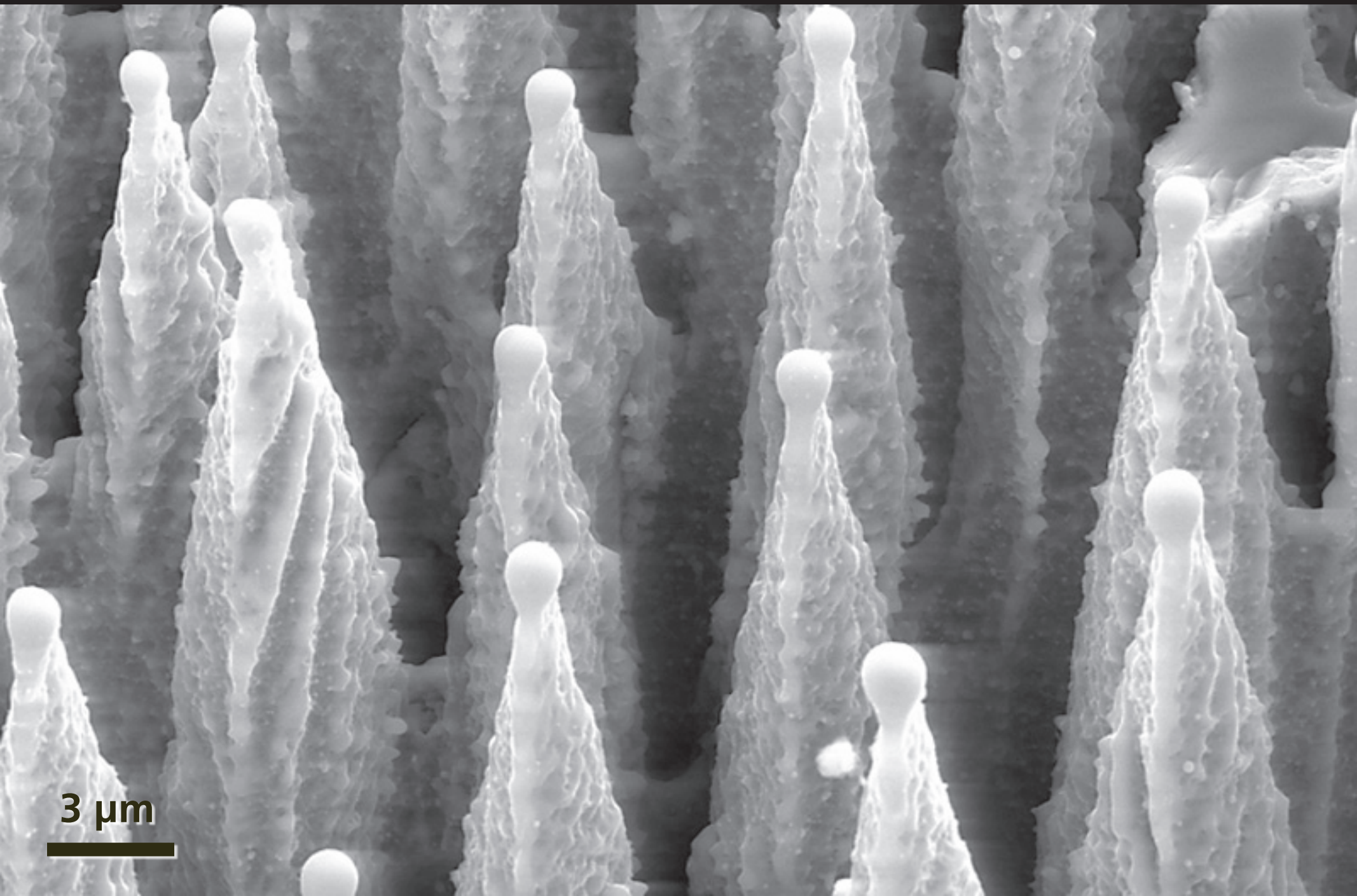

Introduction

absorptance ($1 - R_{int} - T_{int}$)

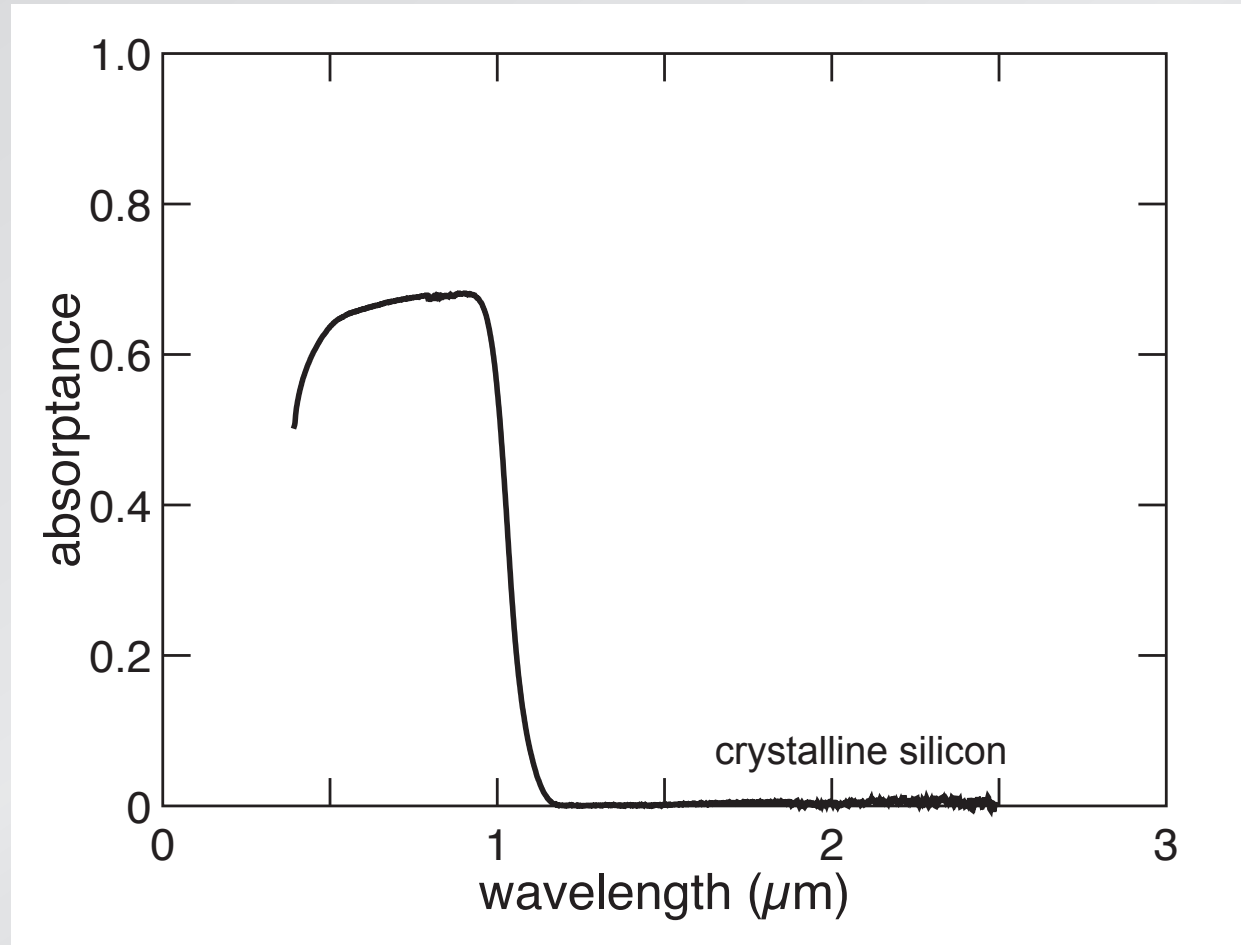

Introduction

absorptance ($1 - R_{int} - T_{int}$)

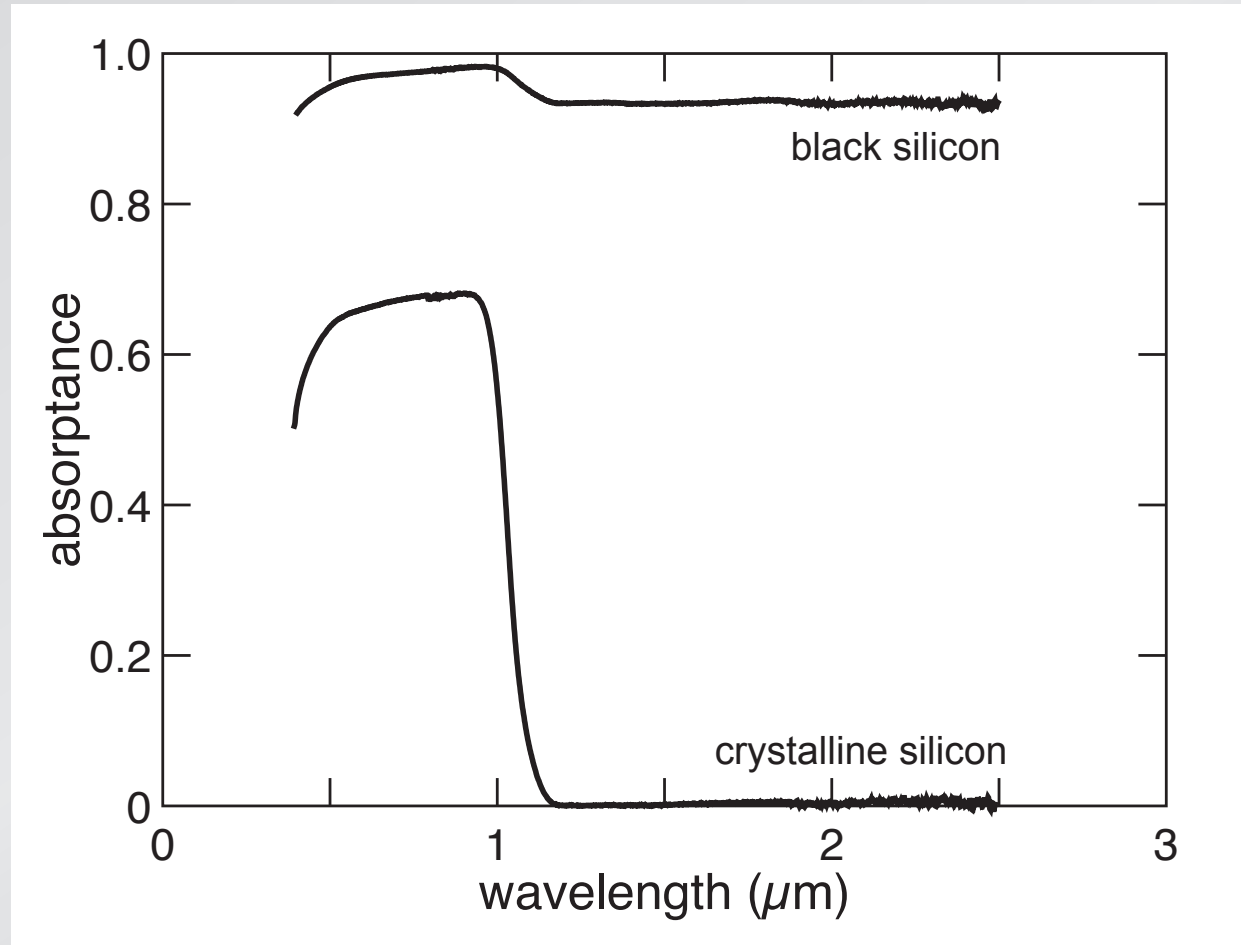

Introduction

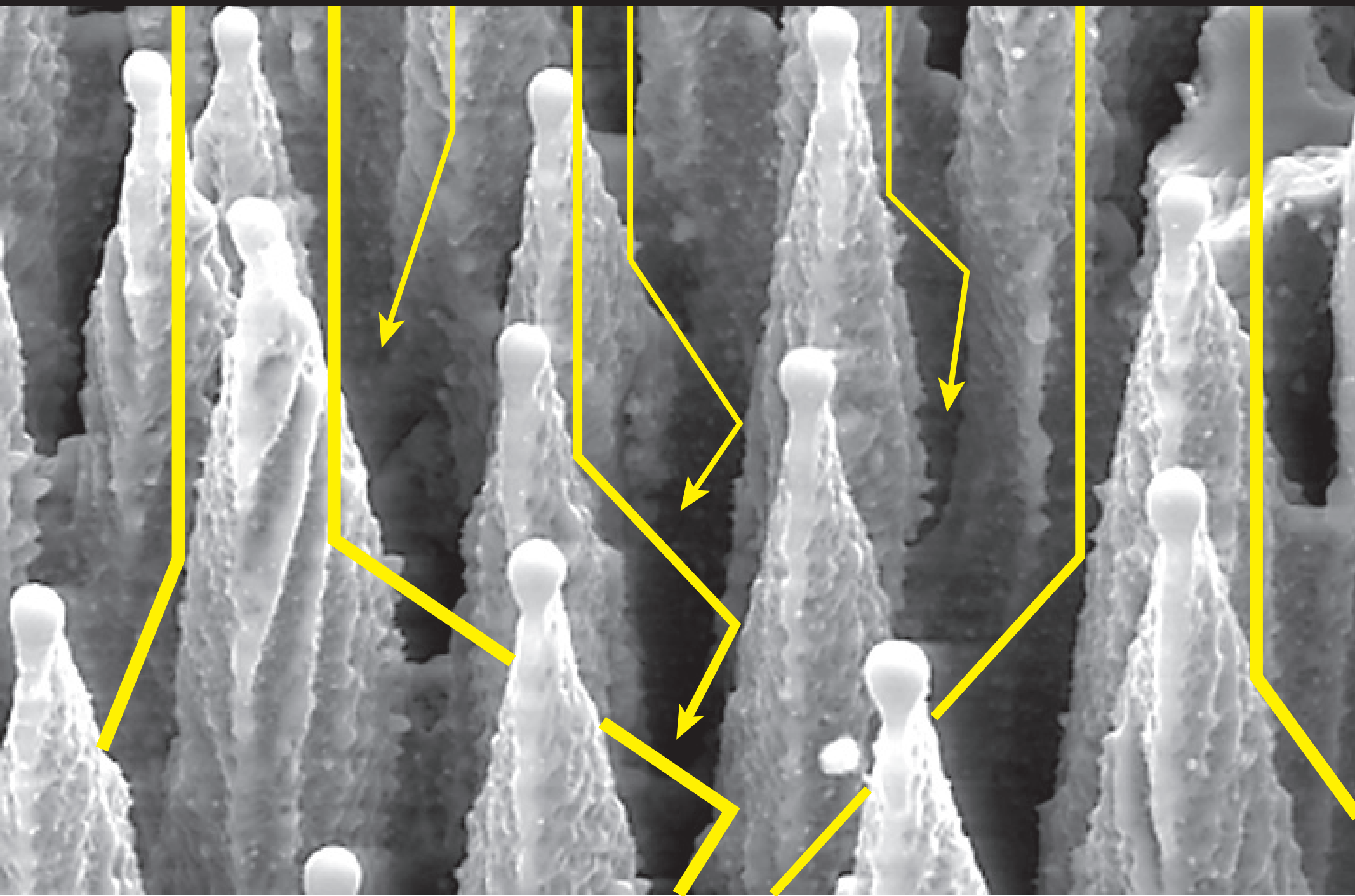

Introduction

absorptance ($1 - R_{int} - T_{int}$)

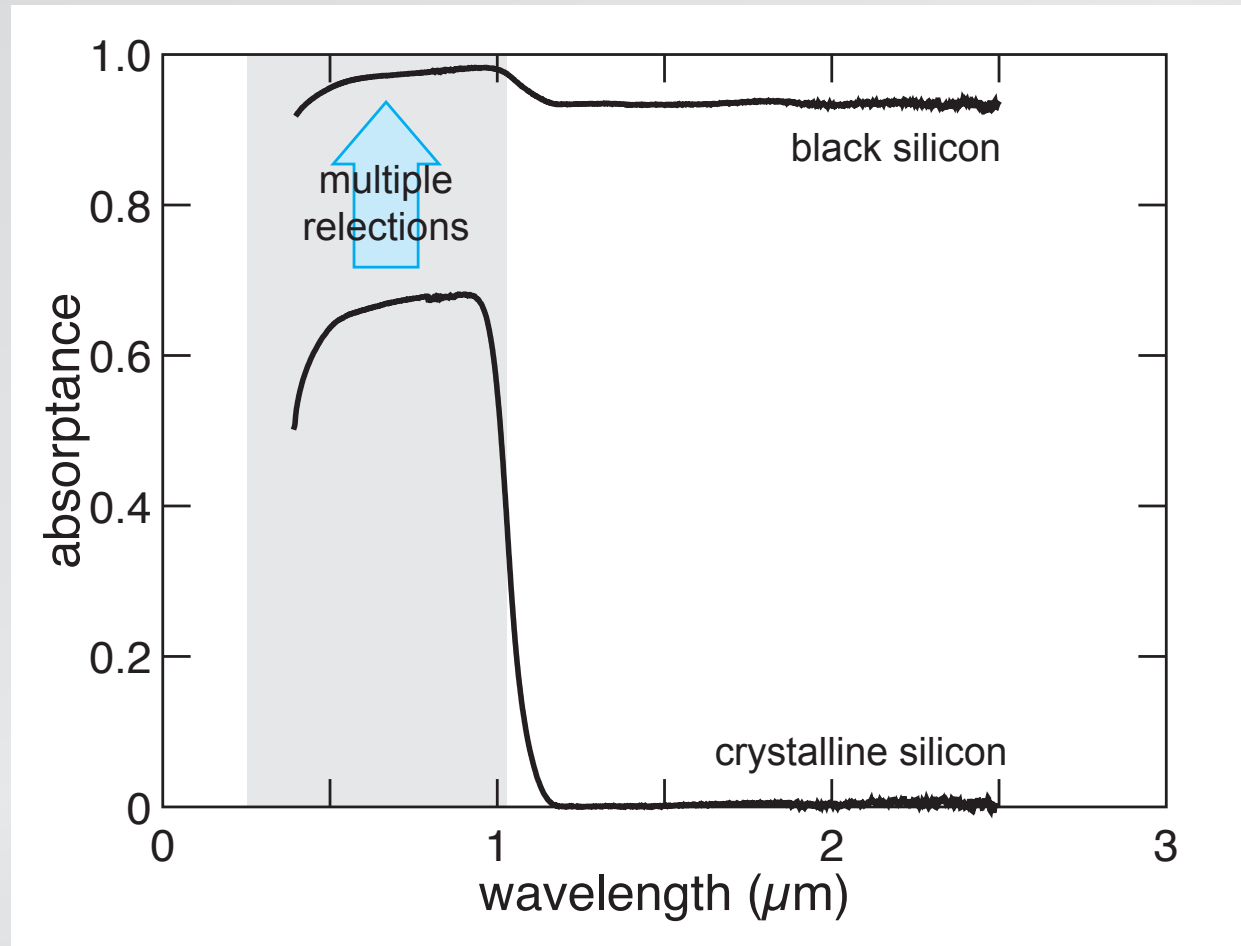

Introduction

silicon transparent in near IR

visible



Introduction

silicon transparent in near IR

visible



near IR

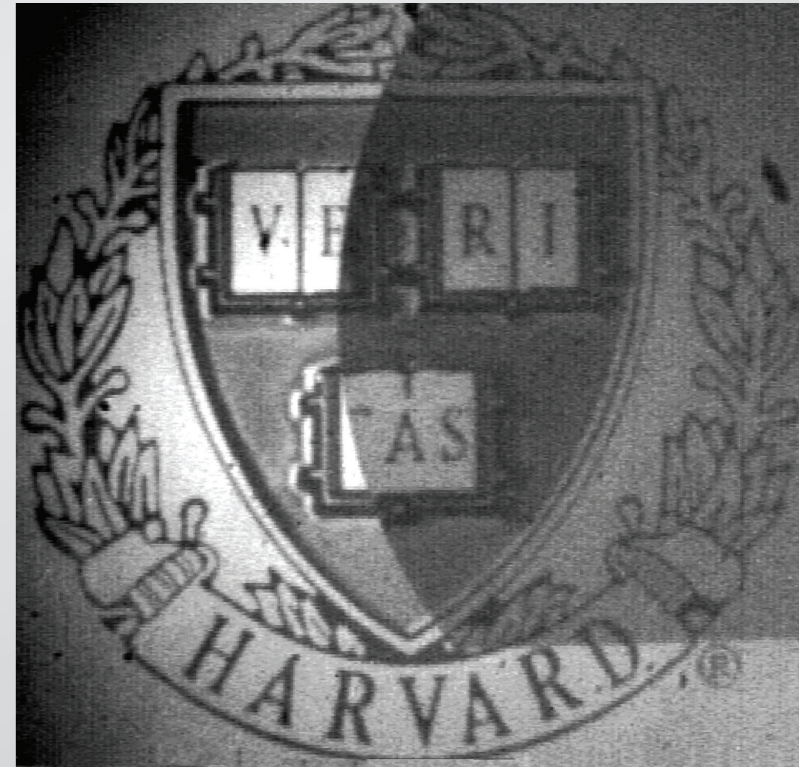

Introduction

roughening doesn't change IR transmission...

polished

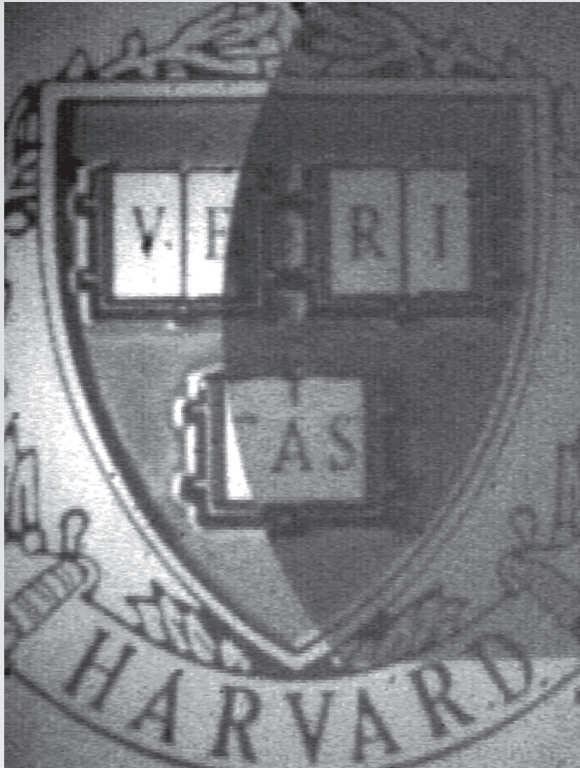

unpolished

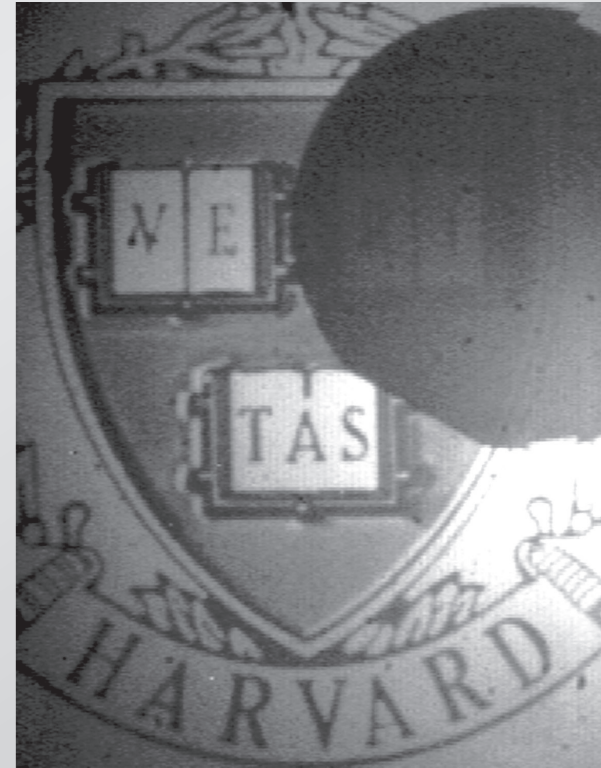

Introduction

roughening doesn't change IR transmission...

polished

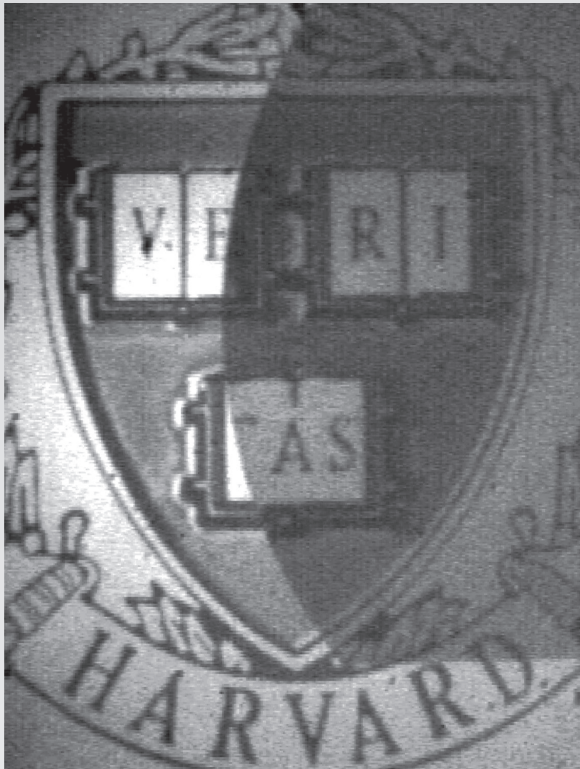

unpolished

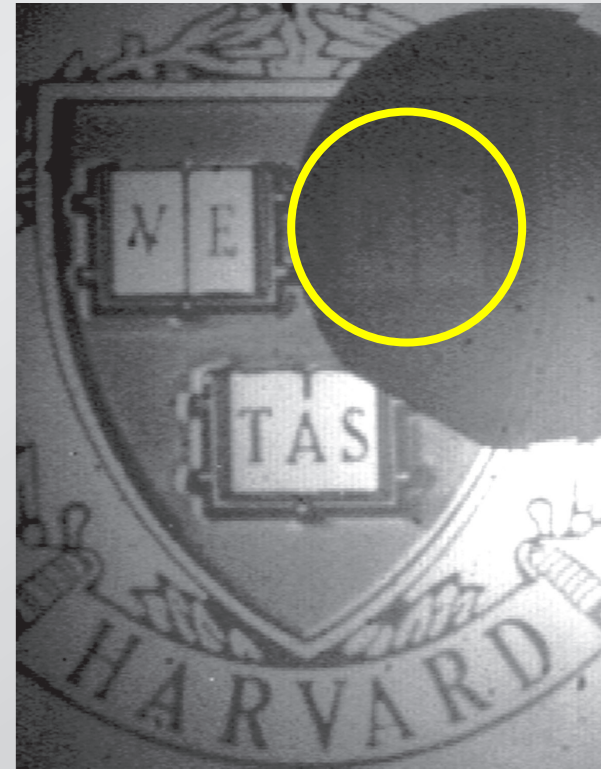

Introduction

...but black silicon blocks IR completely

visible

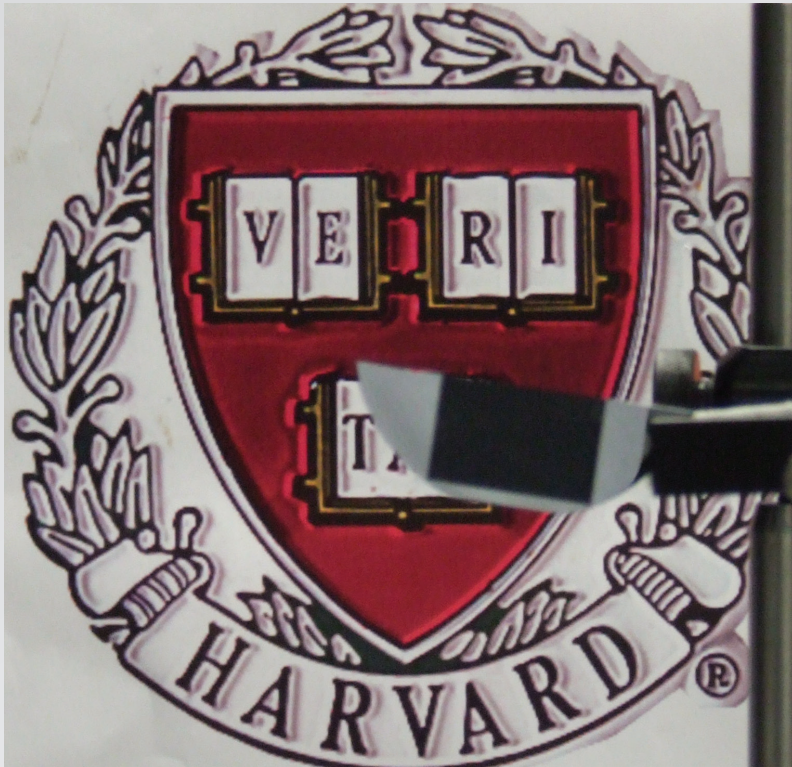

near IR

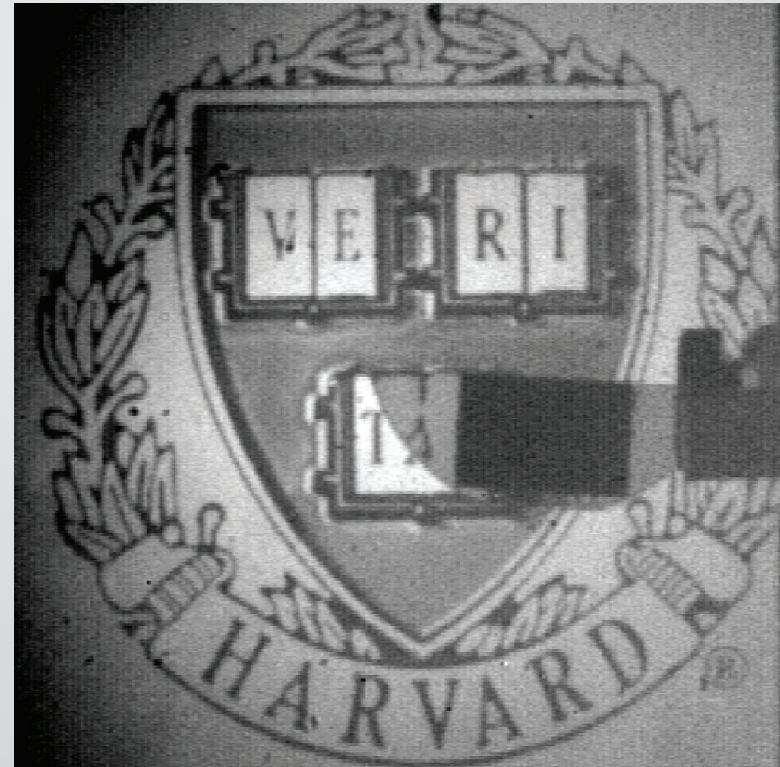

Introduction

...but black silicon blocks IR completely

visible

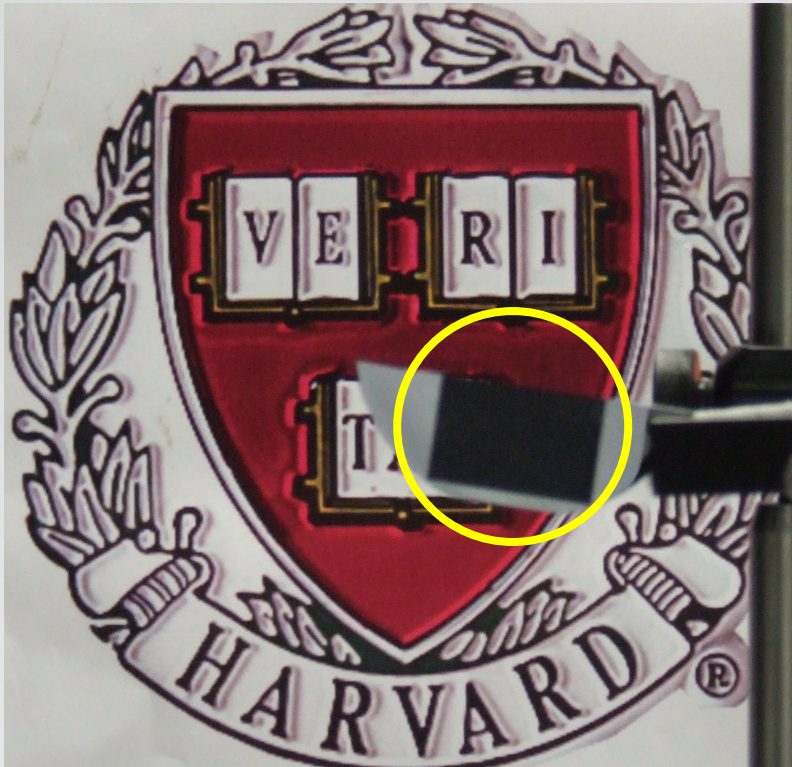

near IR

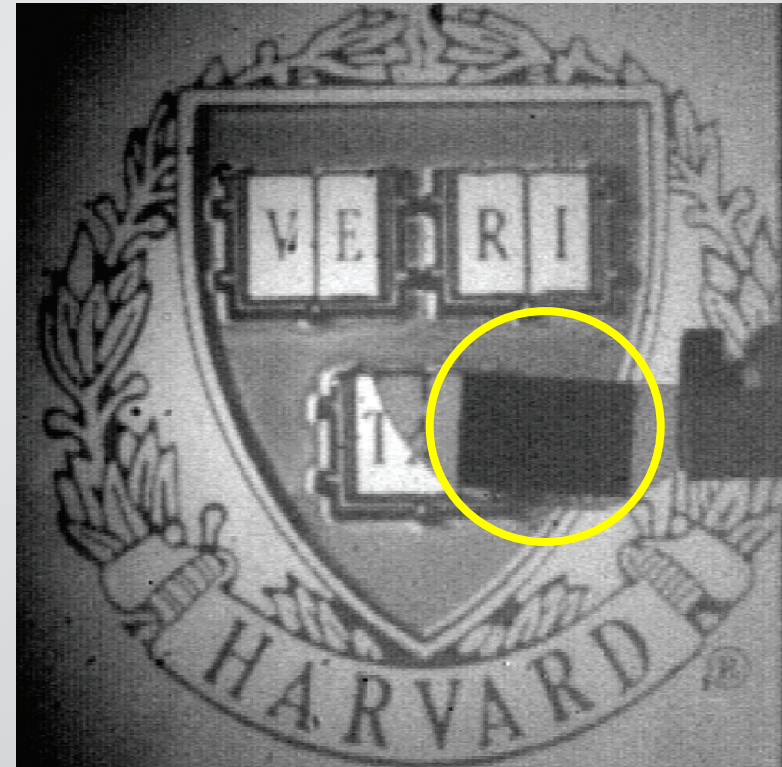

Introduction

black silicon completely black in IR

visible

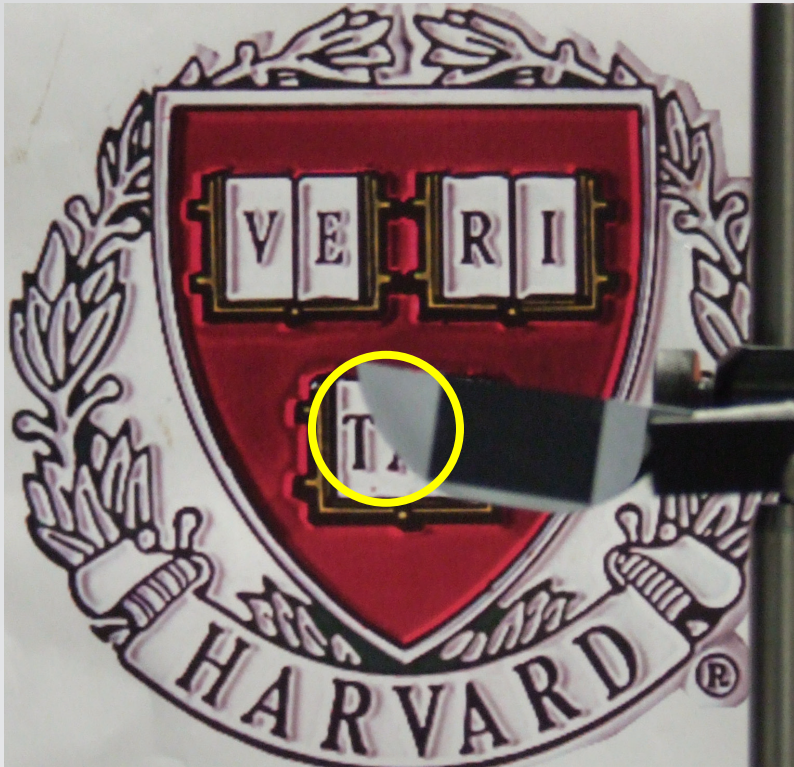

near IR

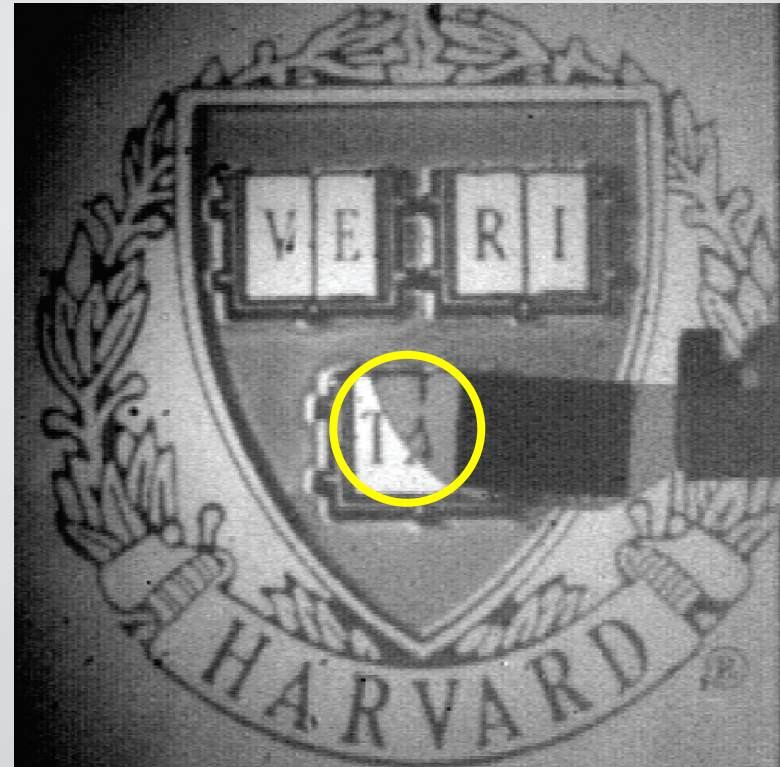

Introduction

band structure changes: defects and/or impurities

Introduction

a decade of research

OPTICAL

UV-VIS-NIR
FTIR
photoluminescence
PTD spectroscopy
UPS
XPS

responsivity
photoconductivity

ELECTRONIC

Hall measurements
conductivity
IV rectification
c-AFM

STRUCTURAL

SEM
TEM
EDX
SAD
EXAFS
AFM
SIMS
RBS
ion channeling

Introduction

a decade of research

OPTICAL

UV-VIS-NIR
FTIR
photoluminescence
PTD spectroscopy
UPS
XPS

responsivity
photoconductivity

gap
impurity band
transitions

ELECTRONIC

Hall measurements
conductivity
IV rectification
c-AFM

STRUCTURAL

SEM
TEM
EDX
SAD
EXAFS
AFM
SIMS
RBS
ion channeling

Introduction

a decade of research

OPTICAL	ELECTRONIC	STRUCTURAL
UV-VIS-NIR	Hall measurements	SEM
FTIR	conductivity	TEM
photoluminescence	IV rectification	EDX
PTD spectroscopy	c-AFM	SAD
UPS		EXAFS
XPS		AFM
	responsivity	SIMS
	photoconductivity	RBS
		ion channeling
gap	carrier concentration	
impurity band	mobilities	
transitions	junction properties	

Introduction

a decade of research

OPTICAL	ELECTRONIC	STRUCTURAL
UV-VIS-NIR	Hall measurements	SEM
FTIR	conductivity	TEM
photoluminescence	IV rectification	EDX
PTD spectroscopy	c-AFM	SAD
UPS		EXAFS
XPS		AFM
	responsivity	SIMS
	photoconductivity	RBS
		ion channeling
gap	carrier concentration	morphology
impurity band	mobilities	composition
transitions	junction properties	atomic structure

Introduction

new process & new class of material!

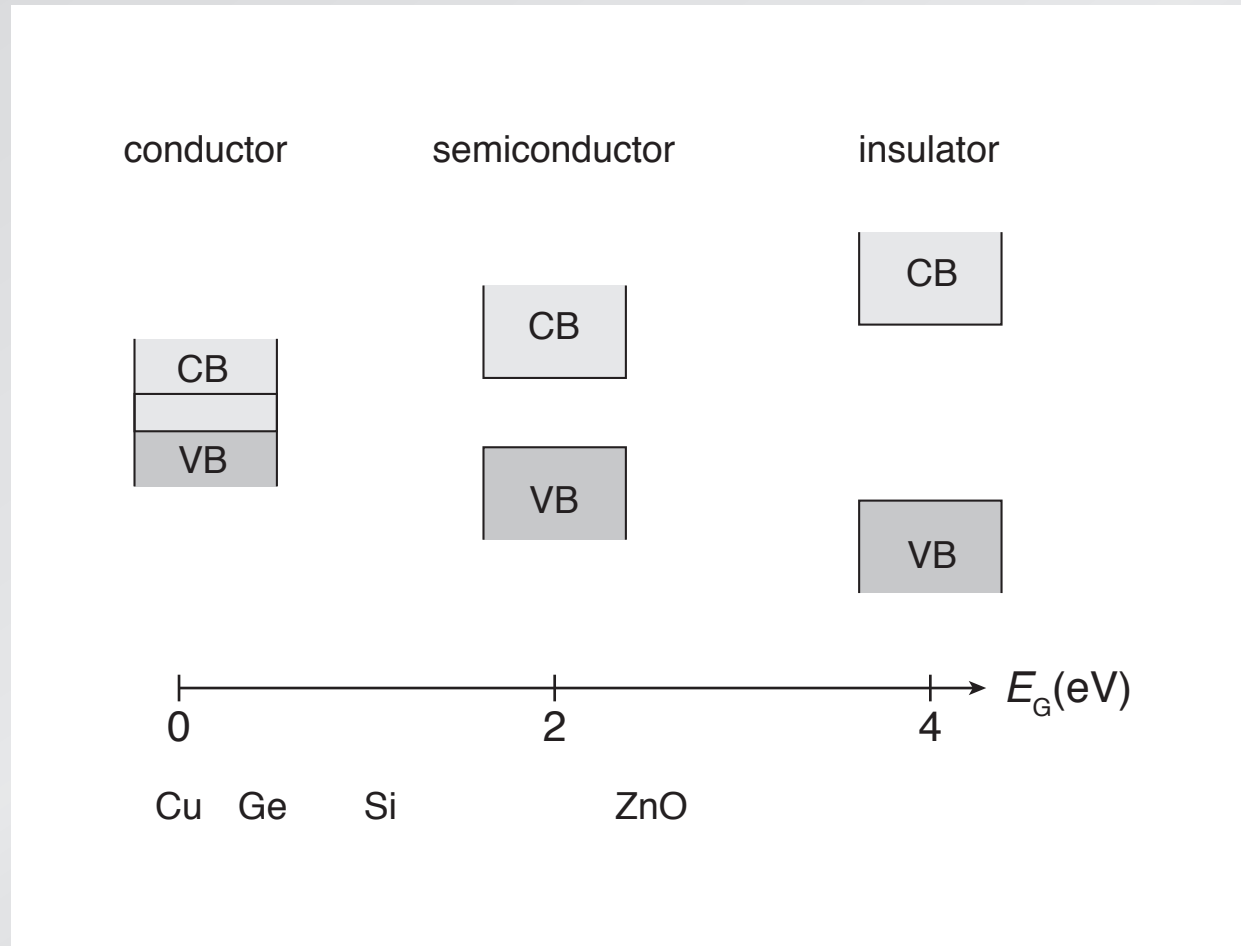

Introduction

gap determines optical and electronic properties

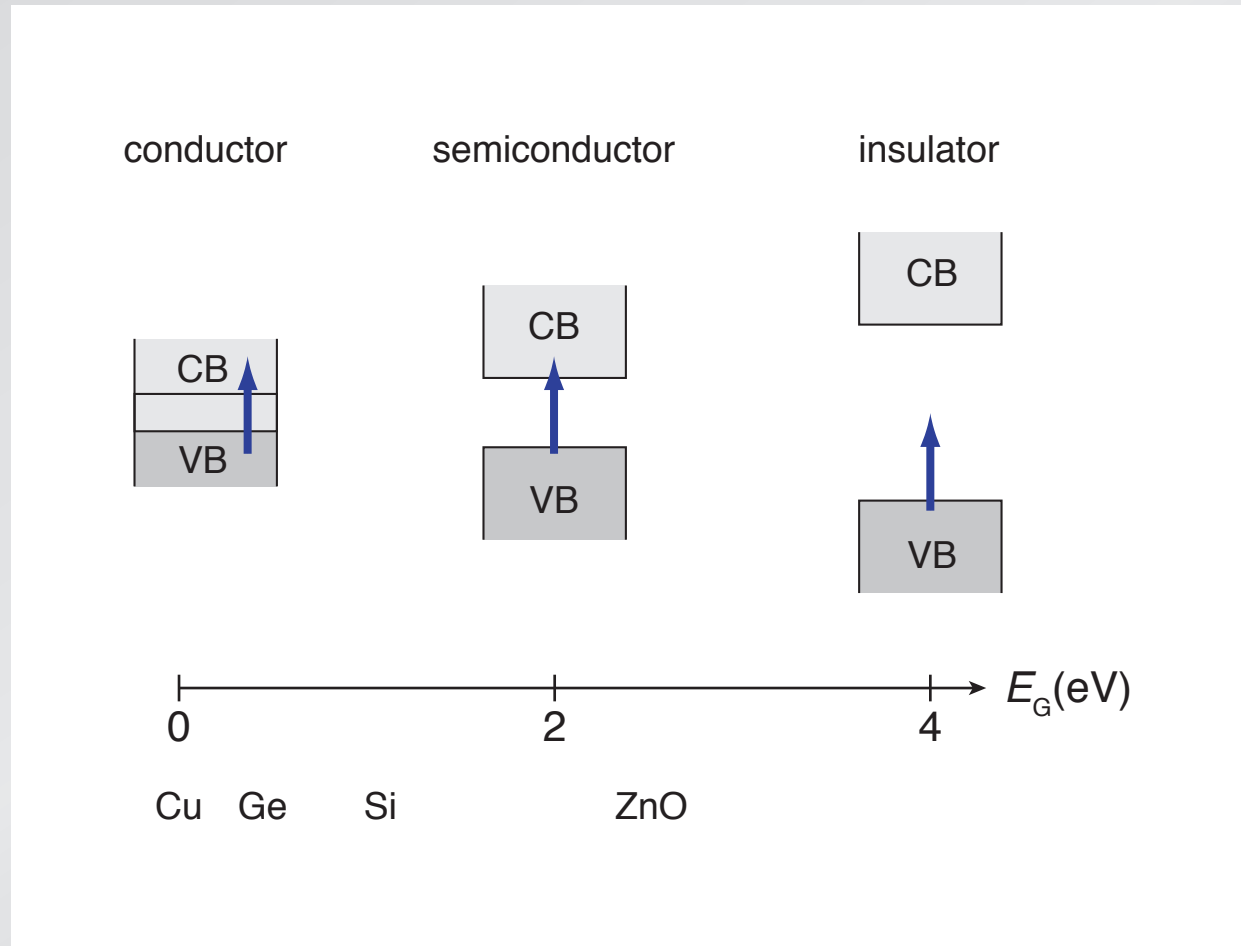

Introduction

shallow-level dopants control electronic properties

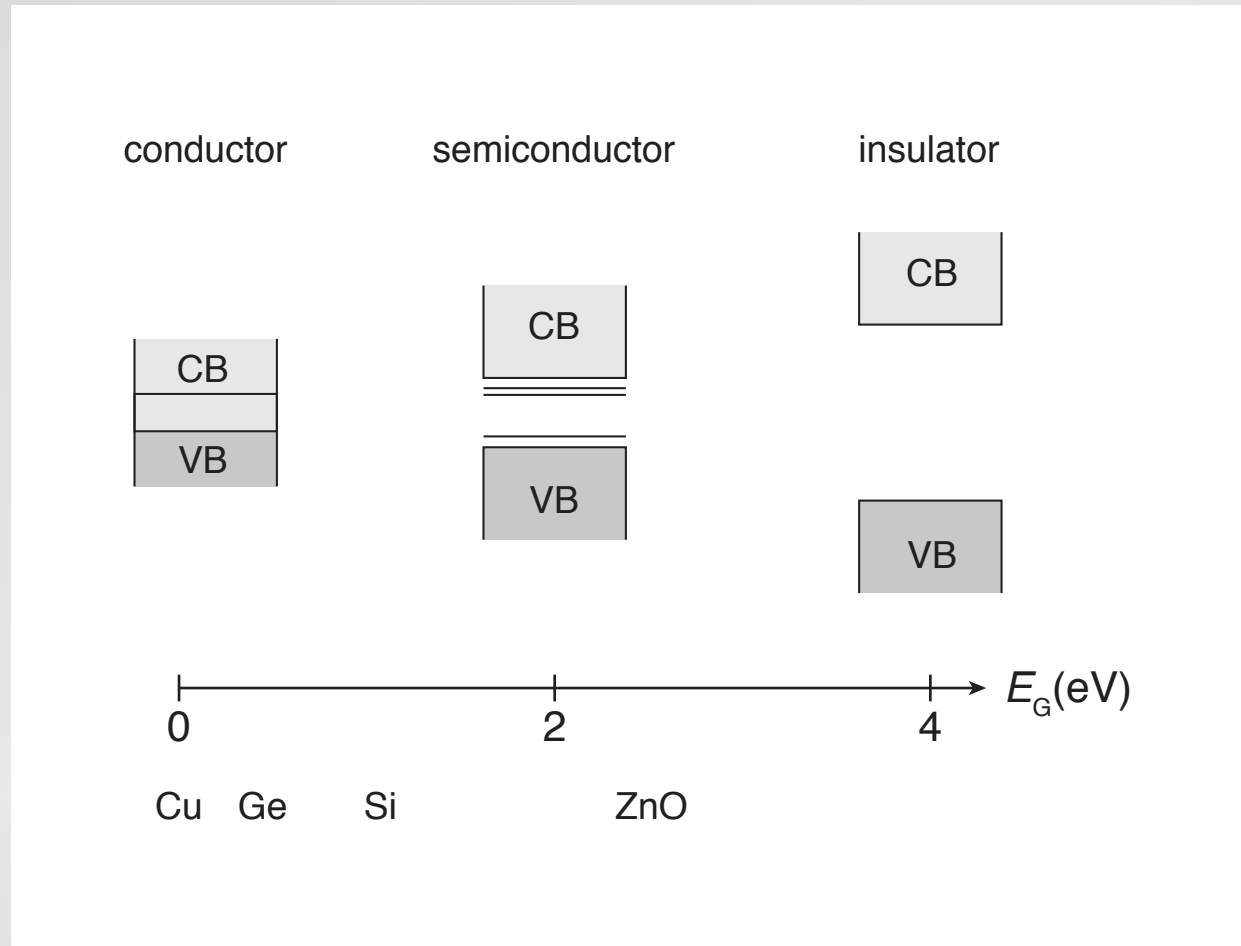

Introduction

shallow-level dopants control electronic properties

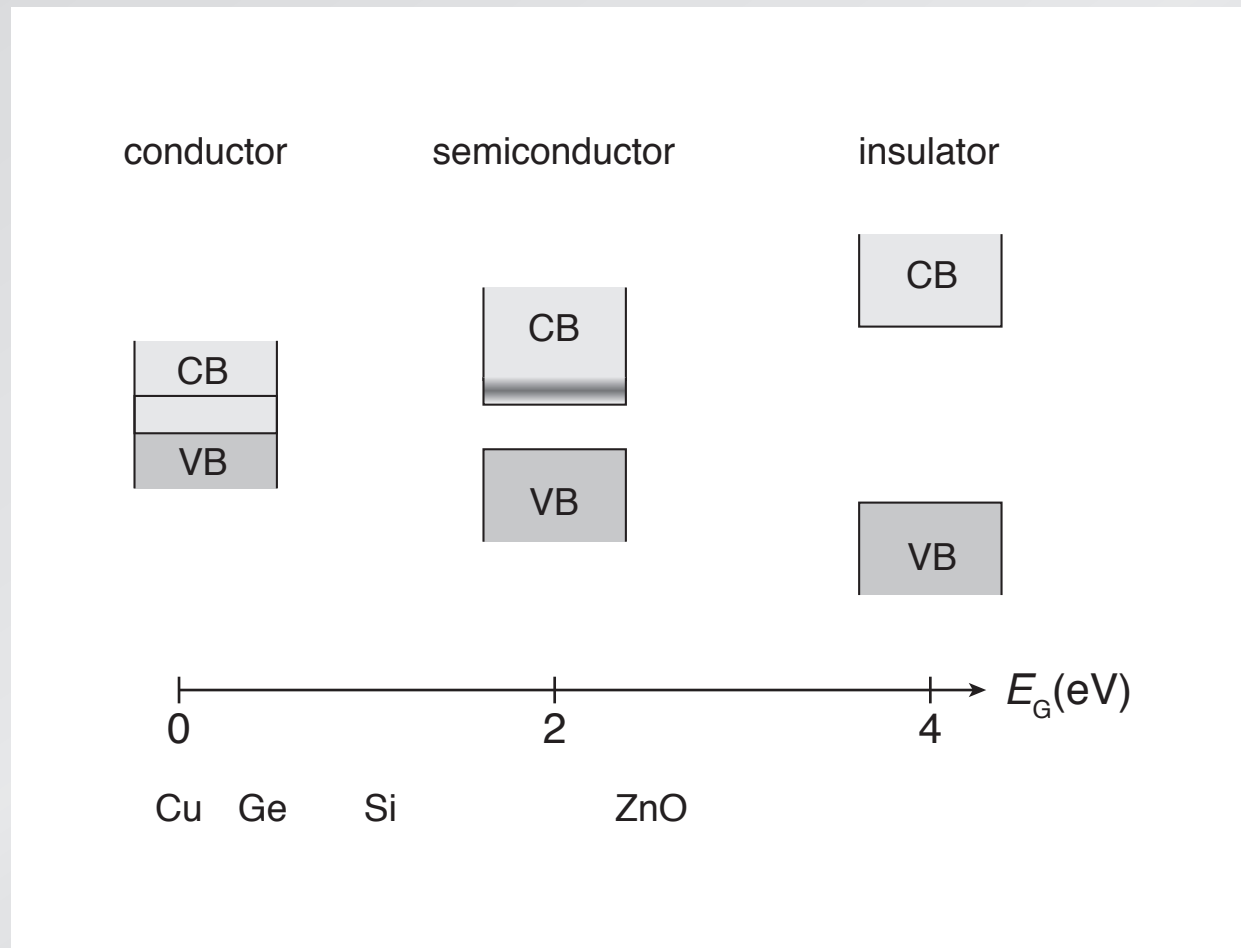

Introduction

deep-level dopants typically avoided

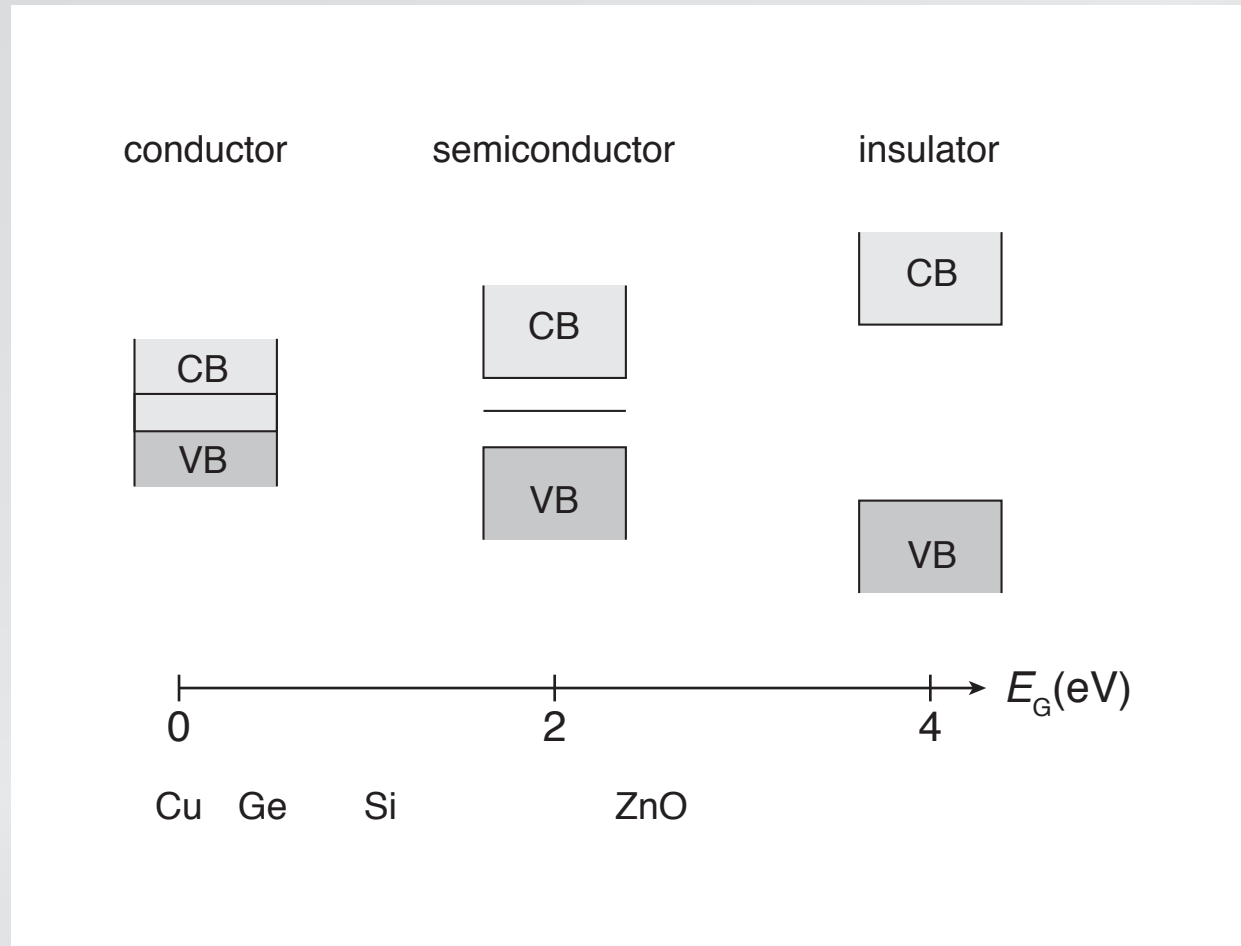

Introduction

femtosecond laser-doping gives rise to intermediate band

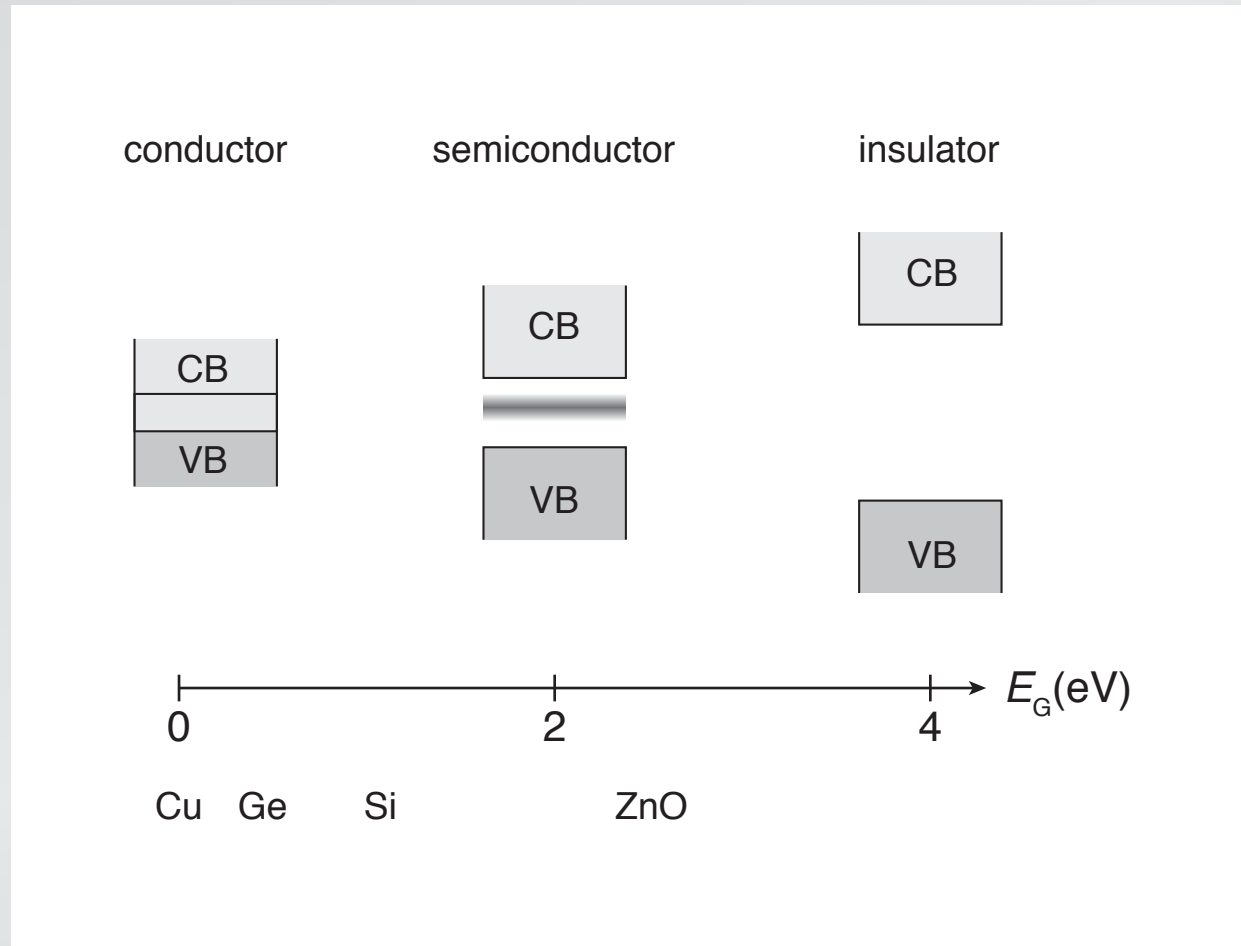

Introduction

substrate/dopant combinations

dopants:

N	O	F
P	S	Cl
	Se	
Sb	Te	

Introduction

substrate/dopant combinations

dopants:

N	O	F
P	S	Cl
	Se	
Sb	Te	

substrates:

Si Ge ZnO InP GaAs

Ti Ag Al Cu Pd Rh Ta Pt

Introduction

focus on chalcogen-doped silicon

dopants:

N	O	F
P	S	Cl
	Se	
Sb	Te	

substrates:

Si Ge ZnO InP GaAs

Ti Ag Al Cu Pd Rh Ta Pt

Introduction

focus on chalcogen-doped silicon

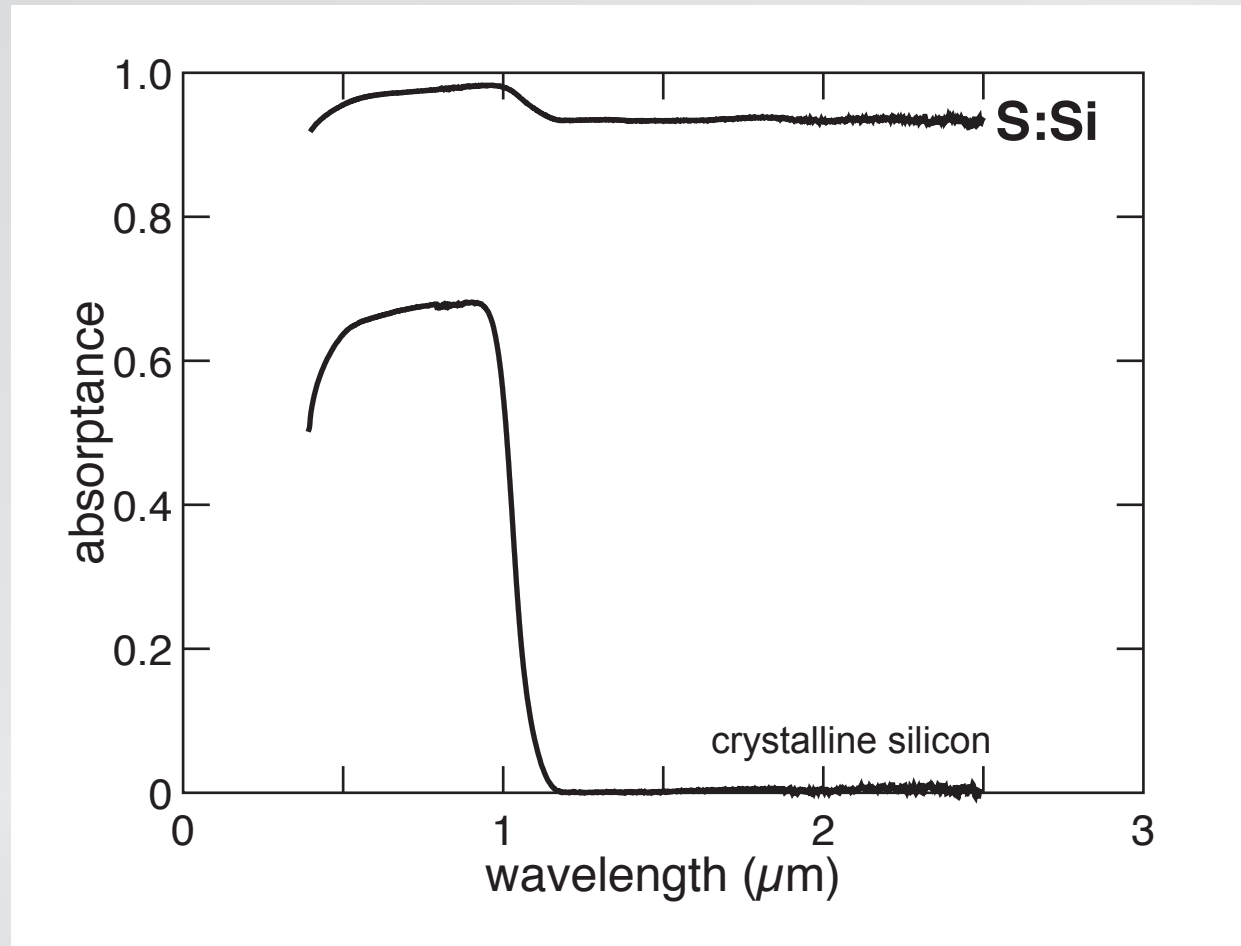

Introduction

focus on chalcogen-doped silicon

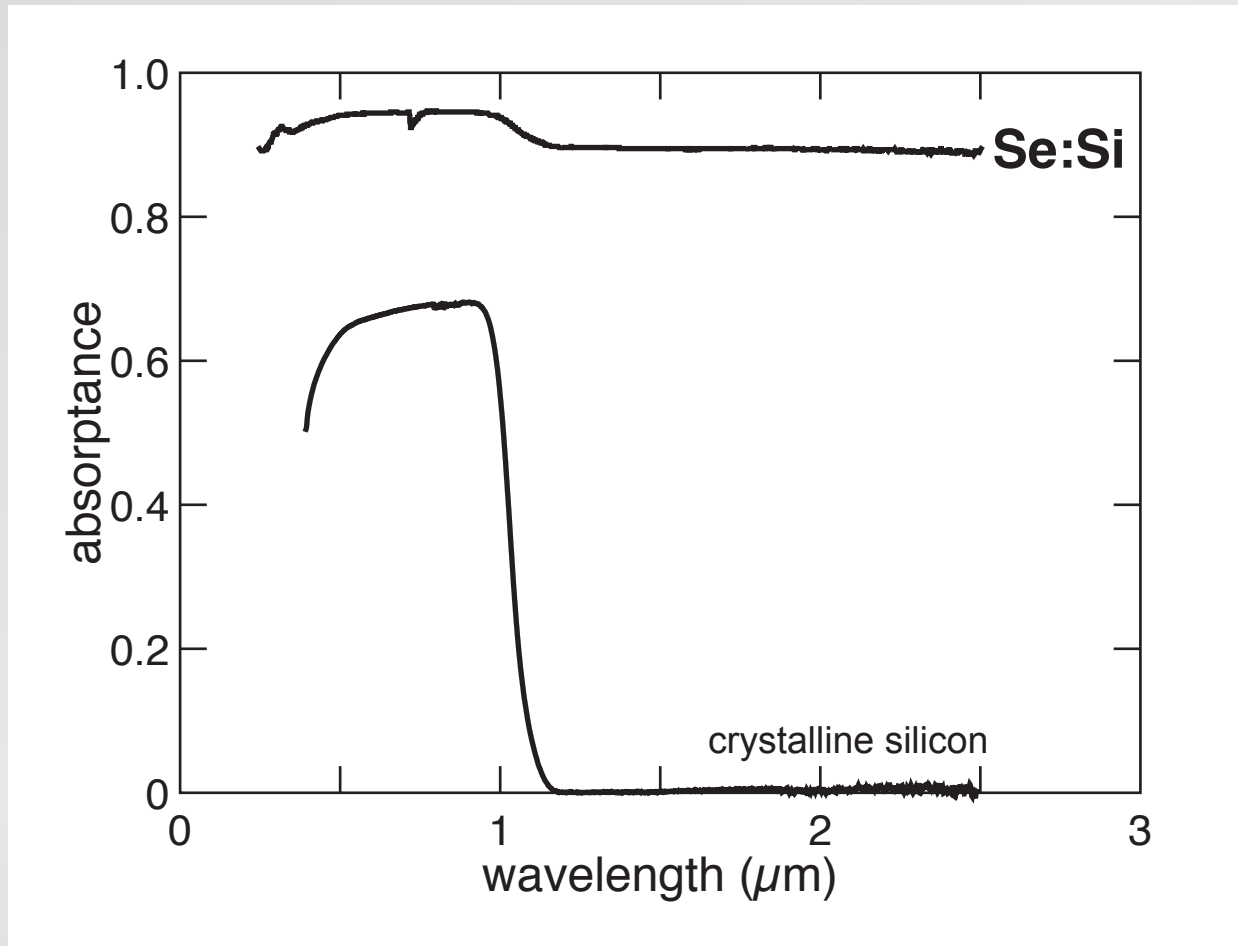

Introduction

focus on chalcogen-doped silicon

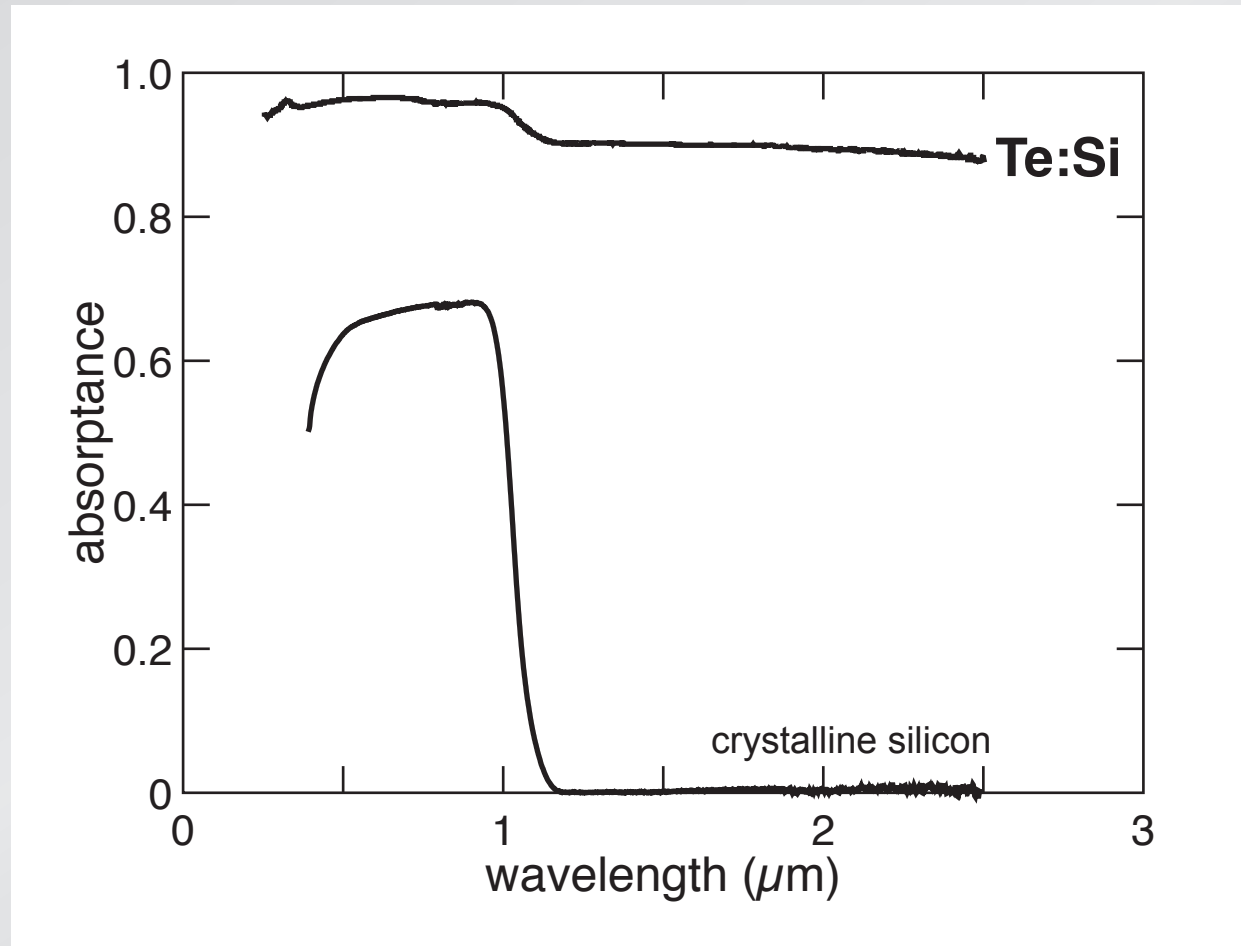

Structure

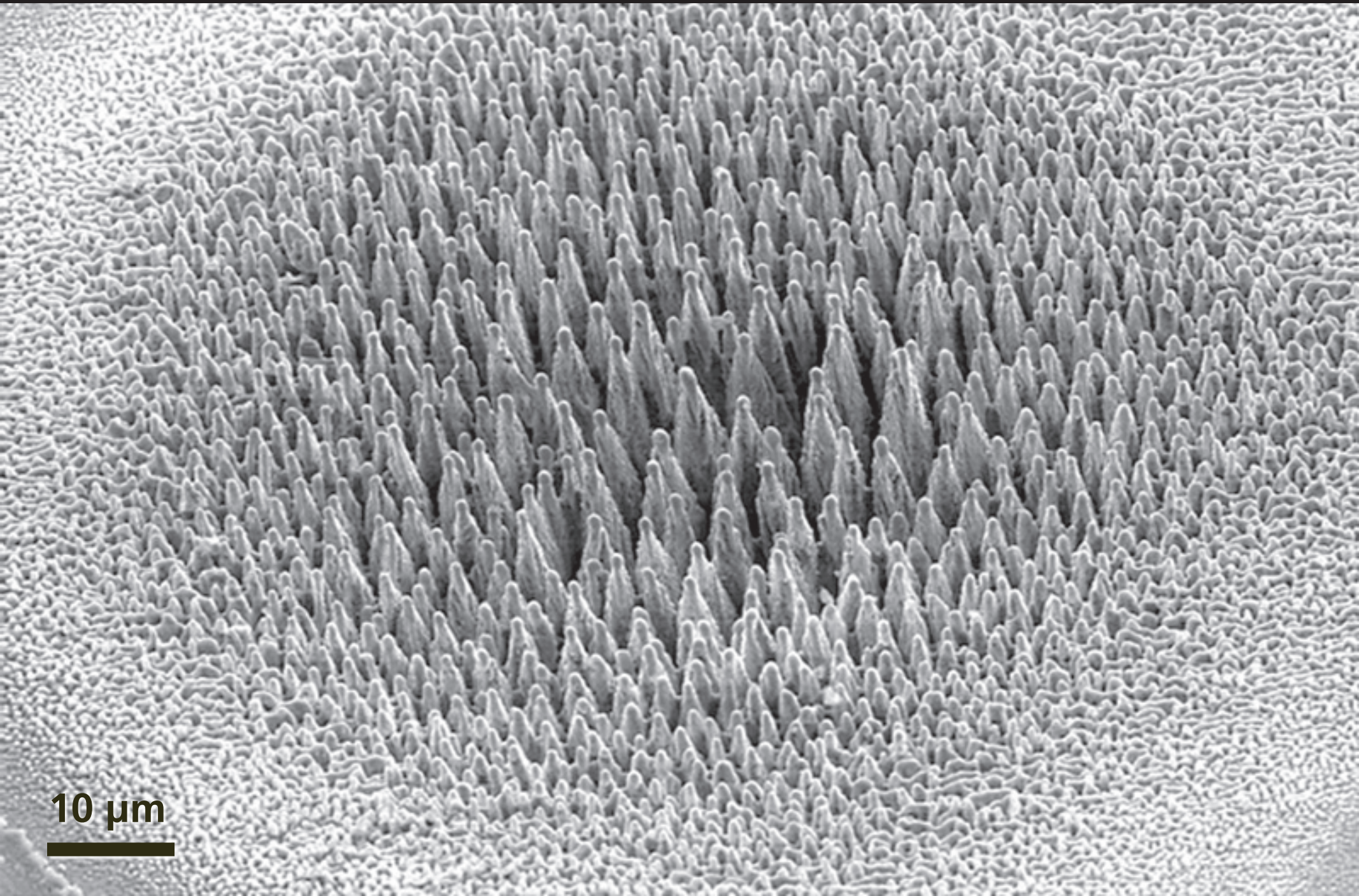

10 μm

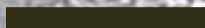

Structure

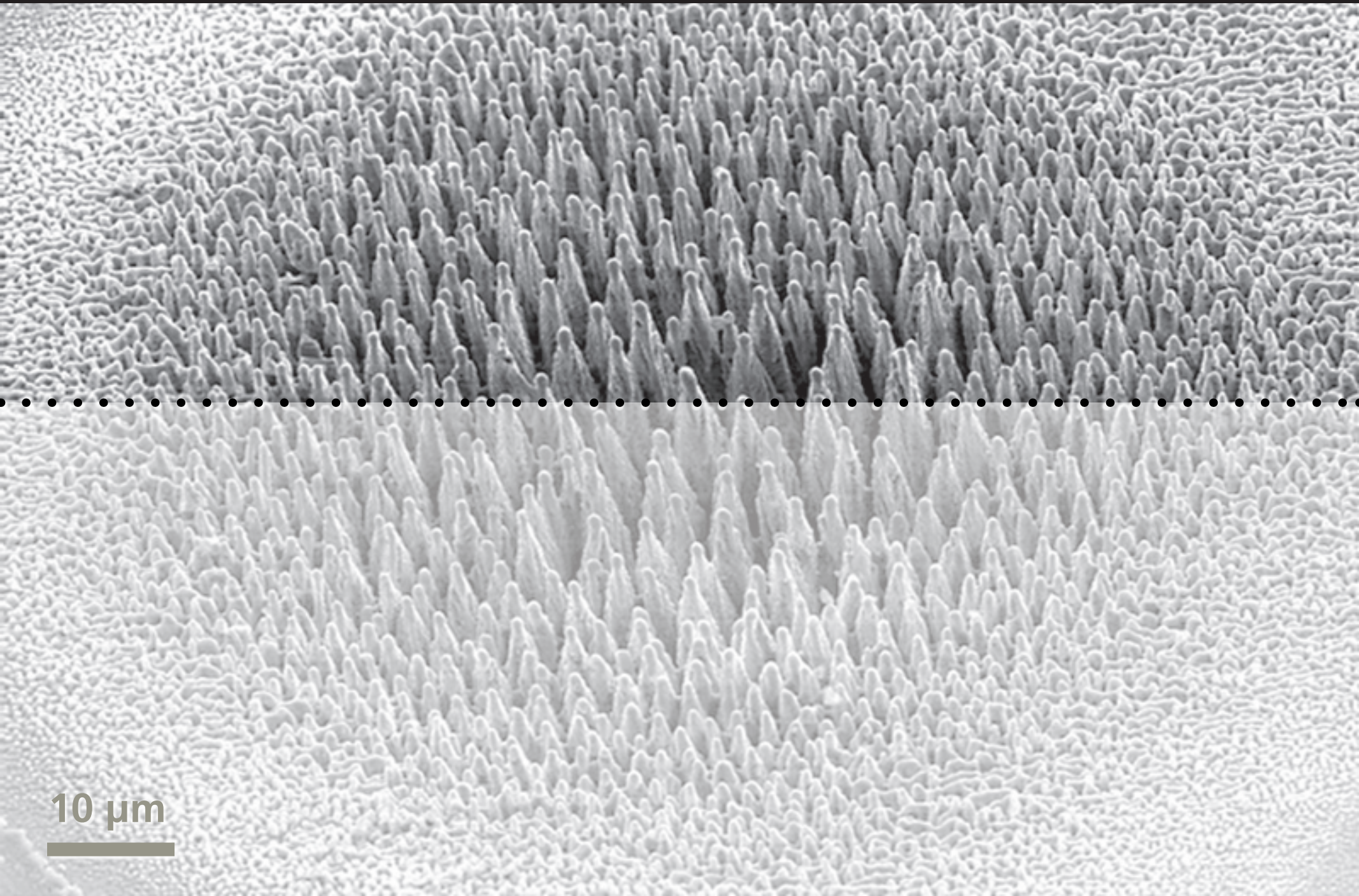

10 μm

Structure

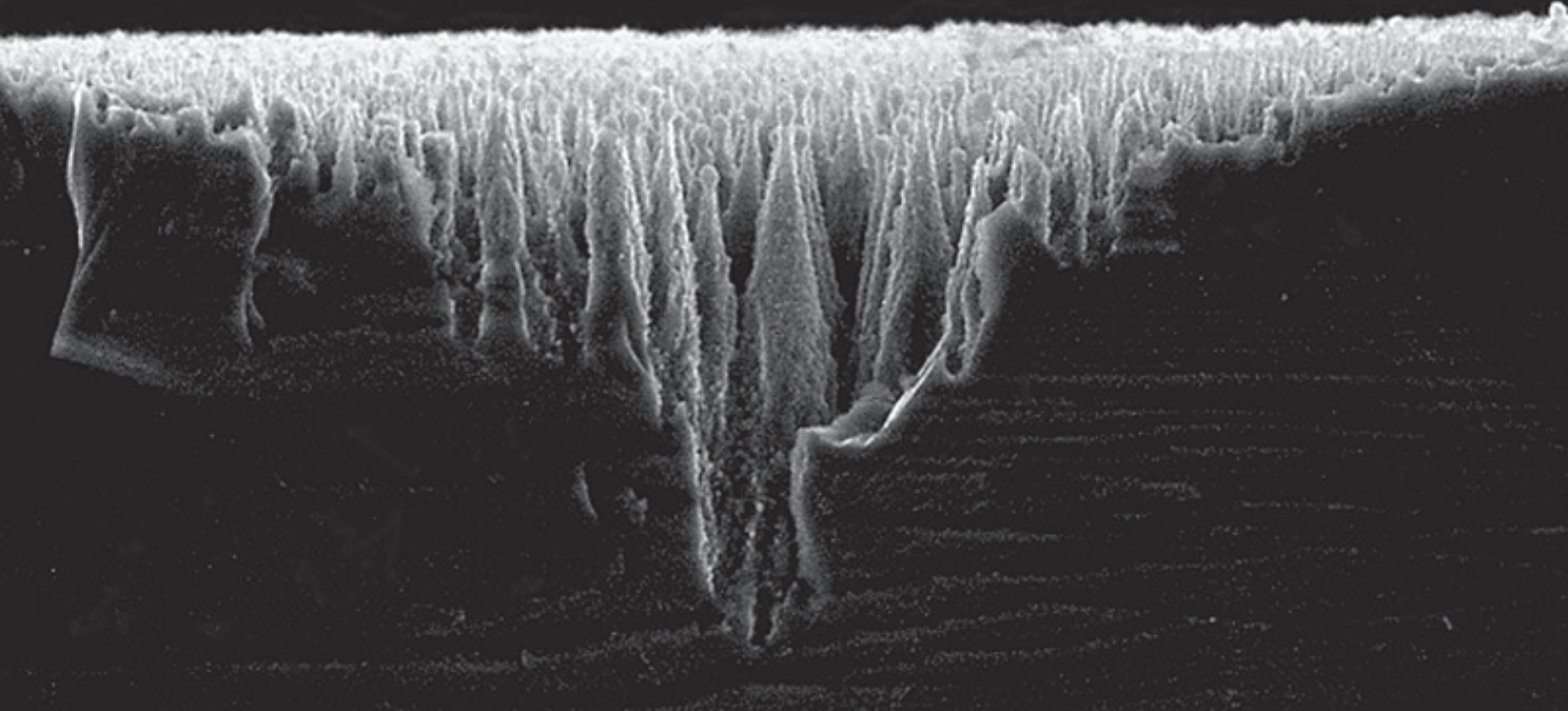

Structure

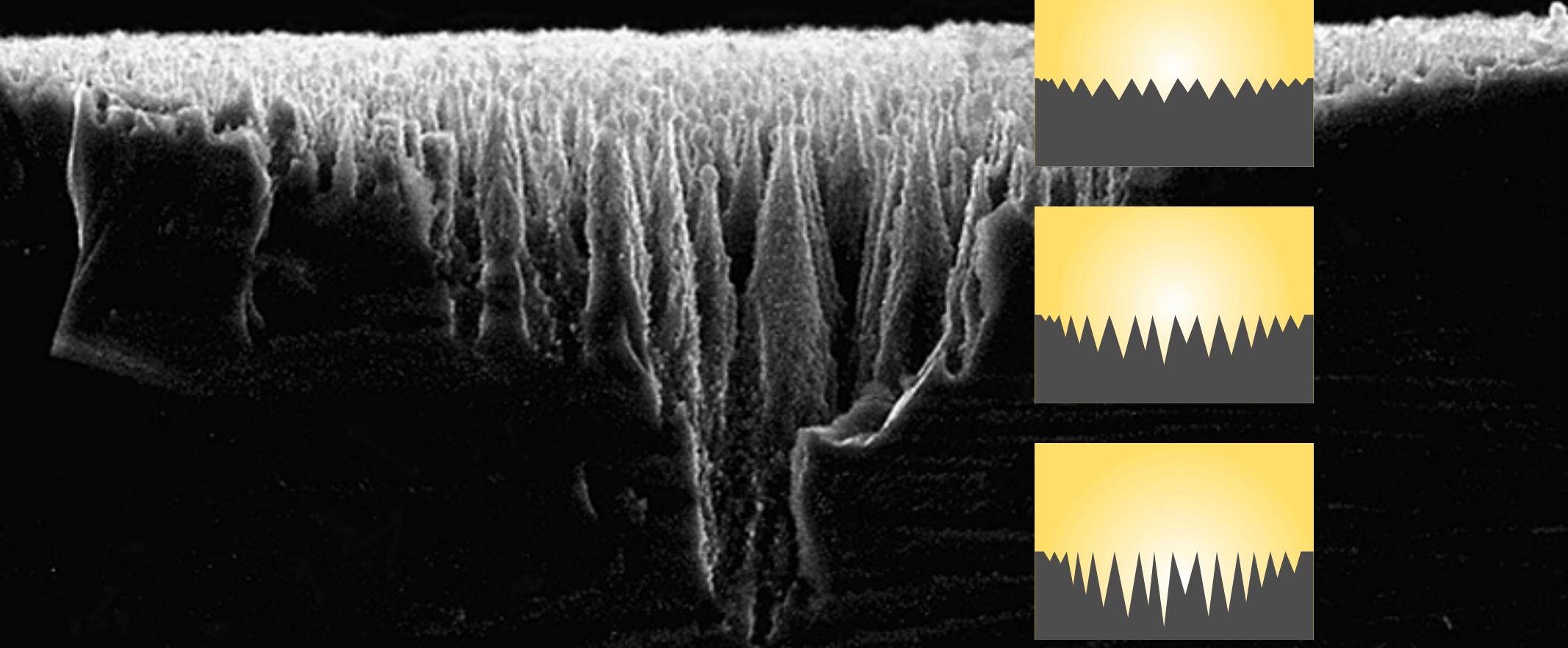

Structure

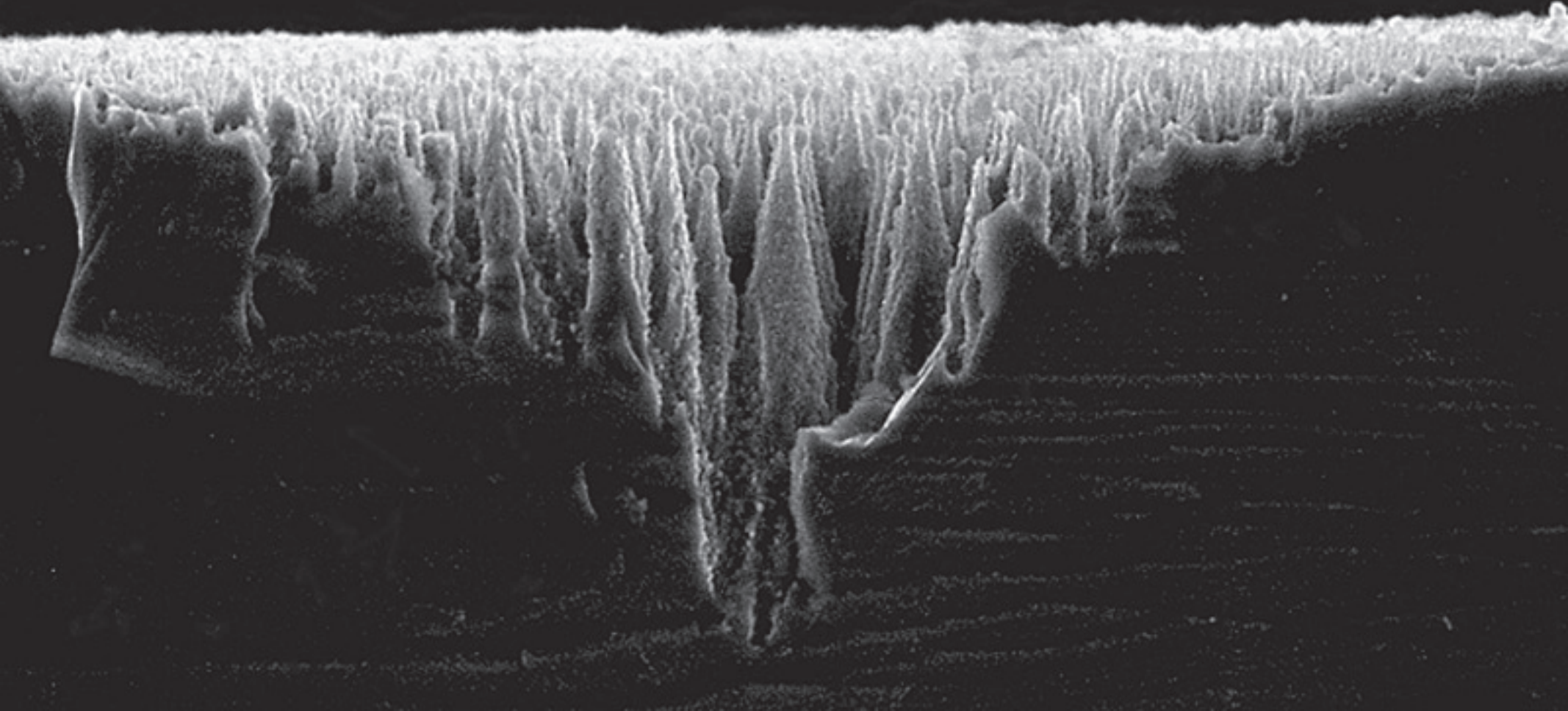

Structure

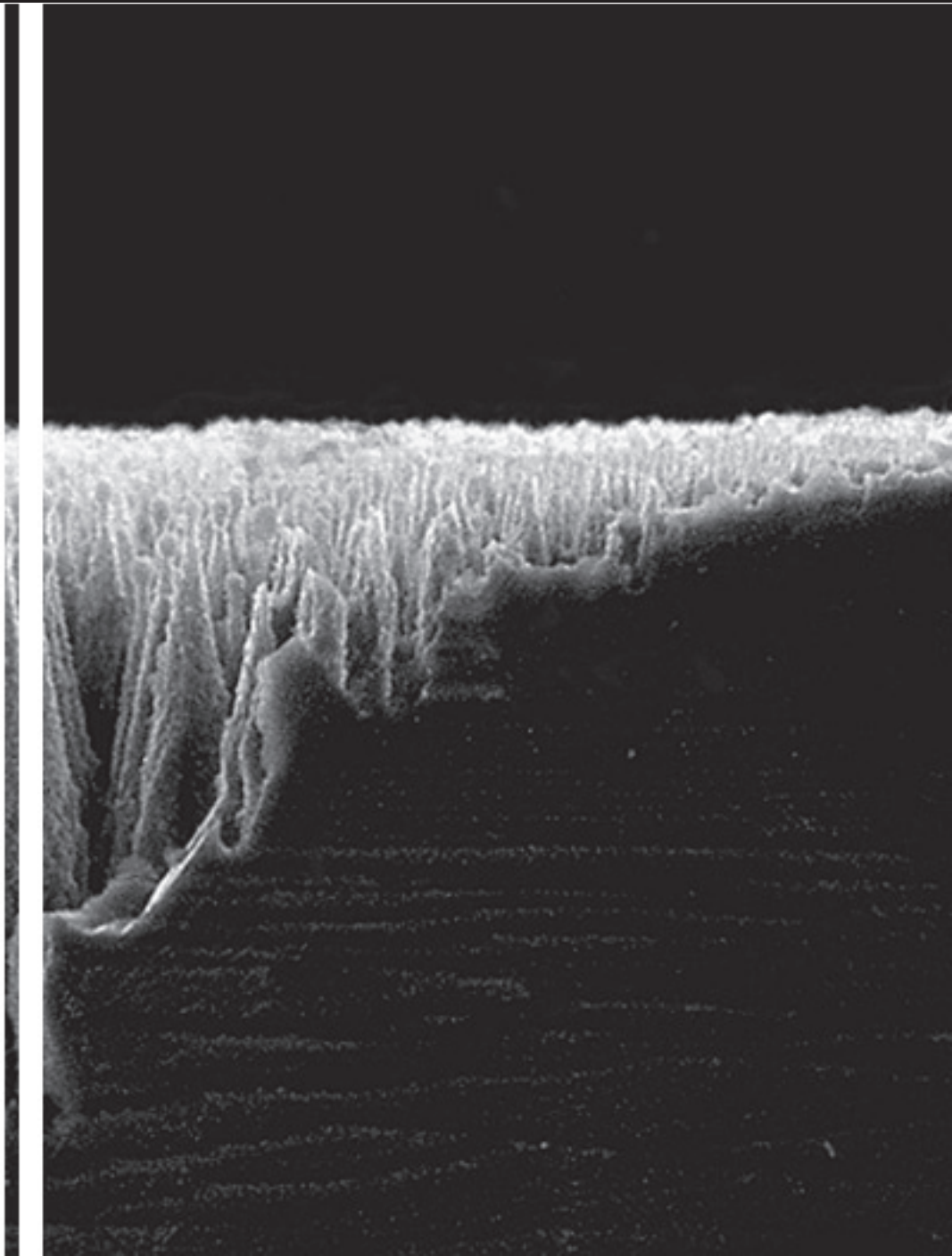
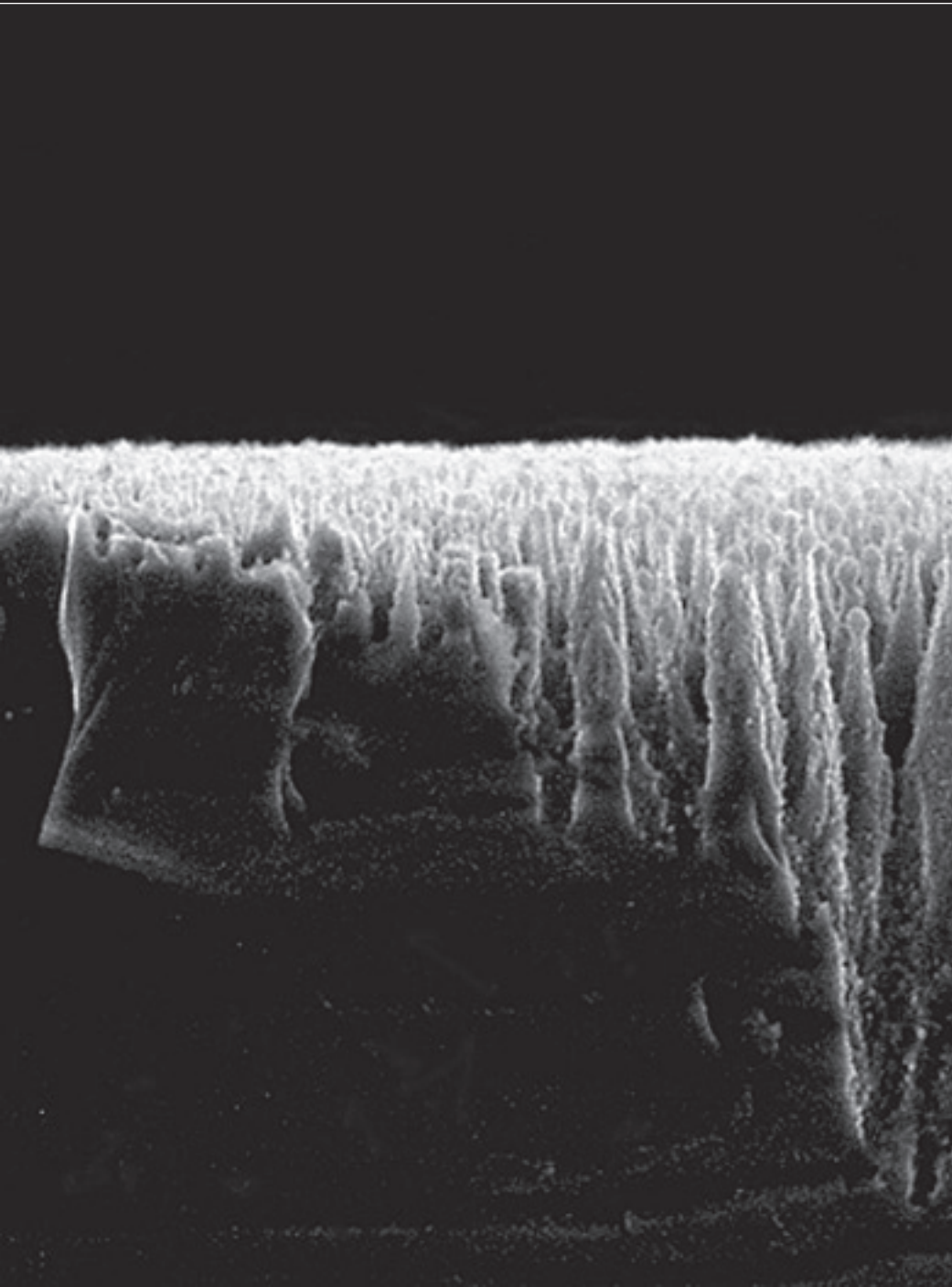

Structure

**cross-sectional
Transmission Electron
Microscopy**

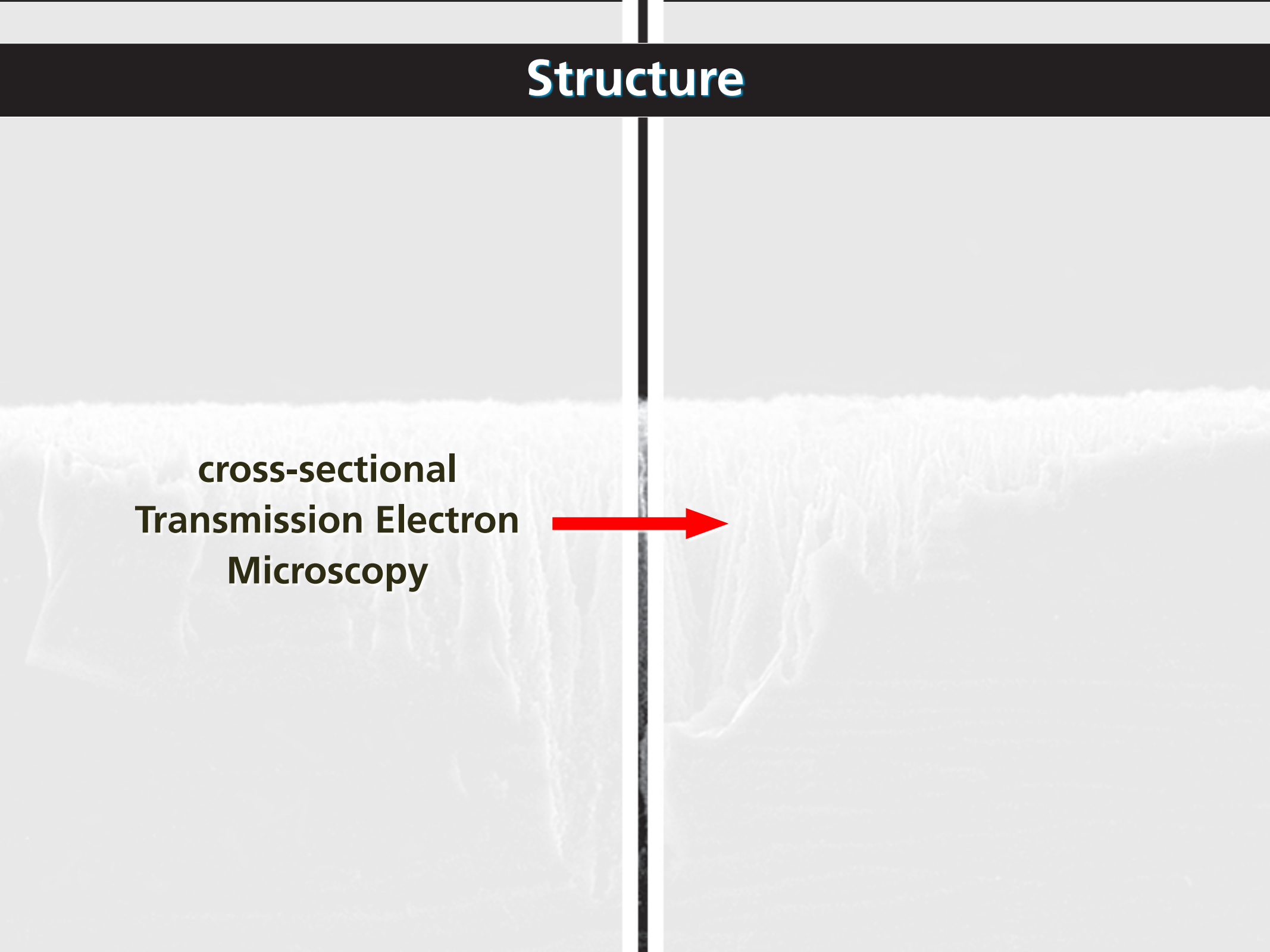

Structure

M. Wall, F. Génin (LLNL)

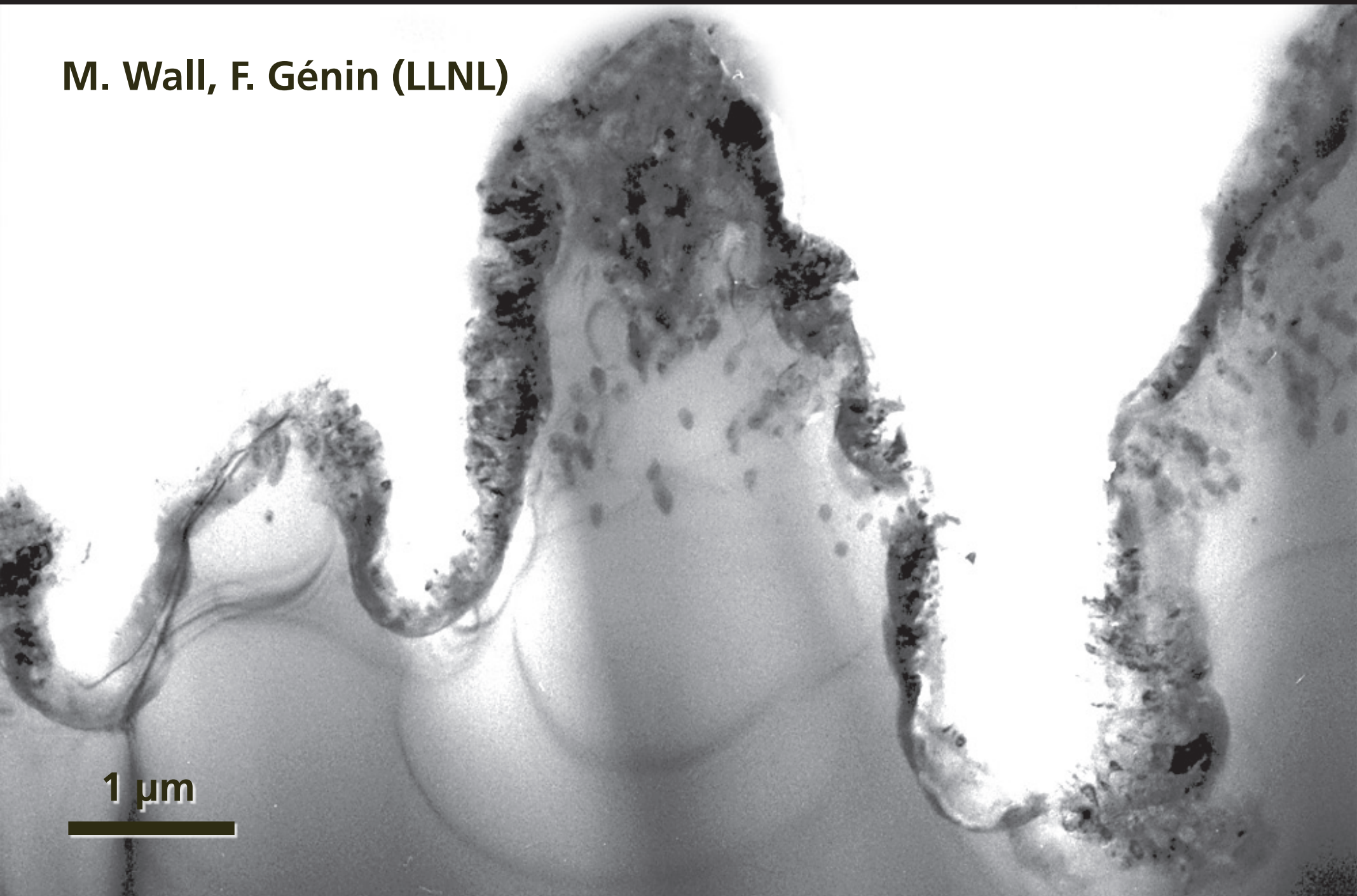

1 μm

Structure

disordered
surface layer

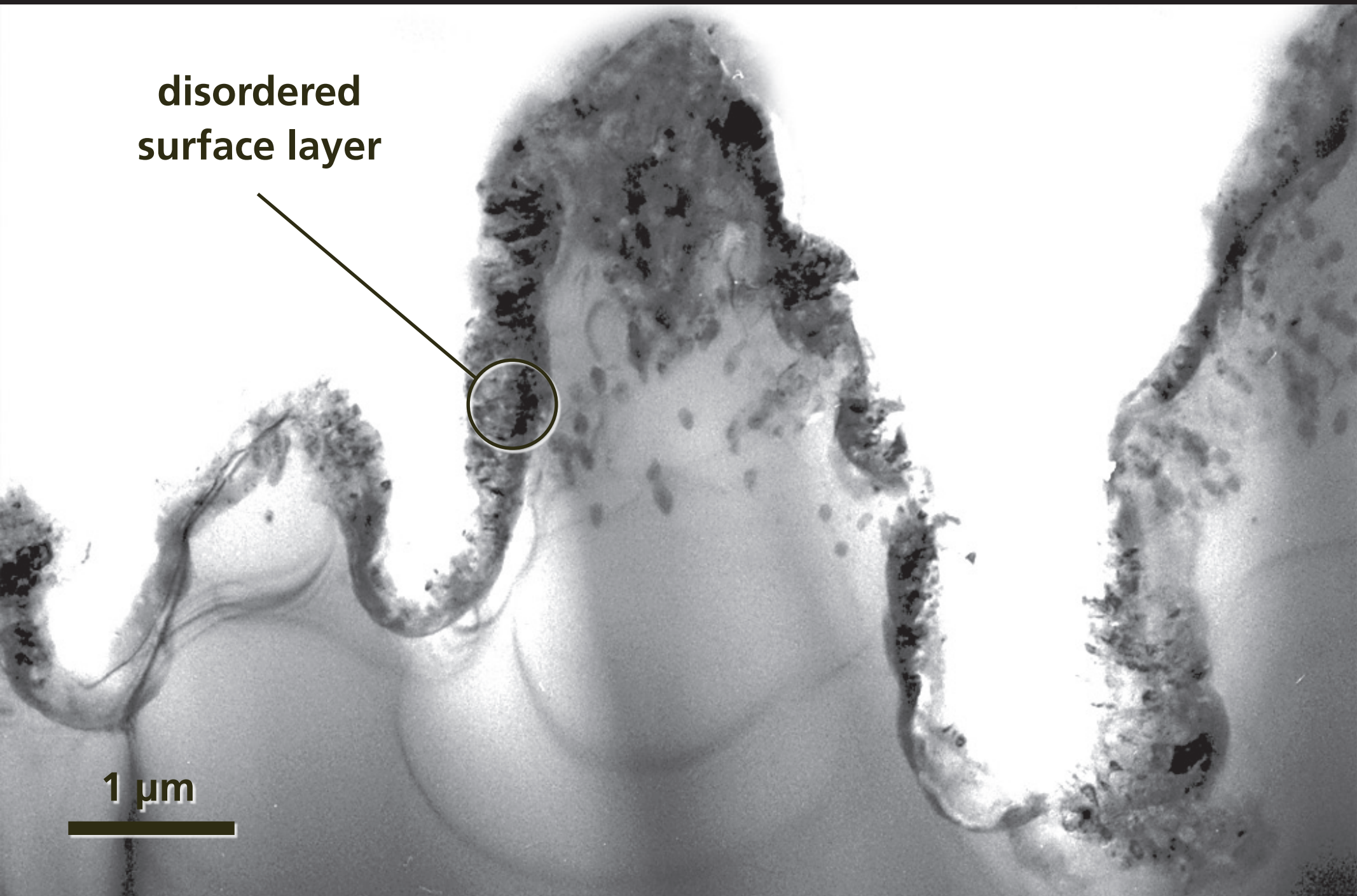

1 μm

Structure

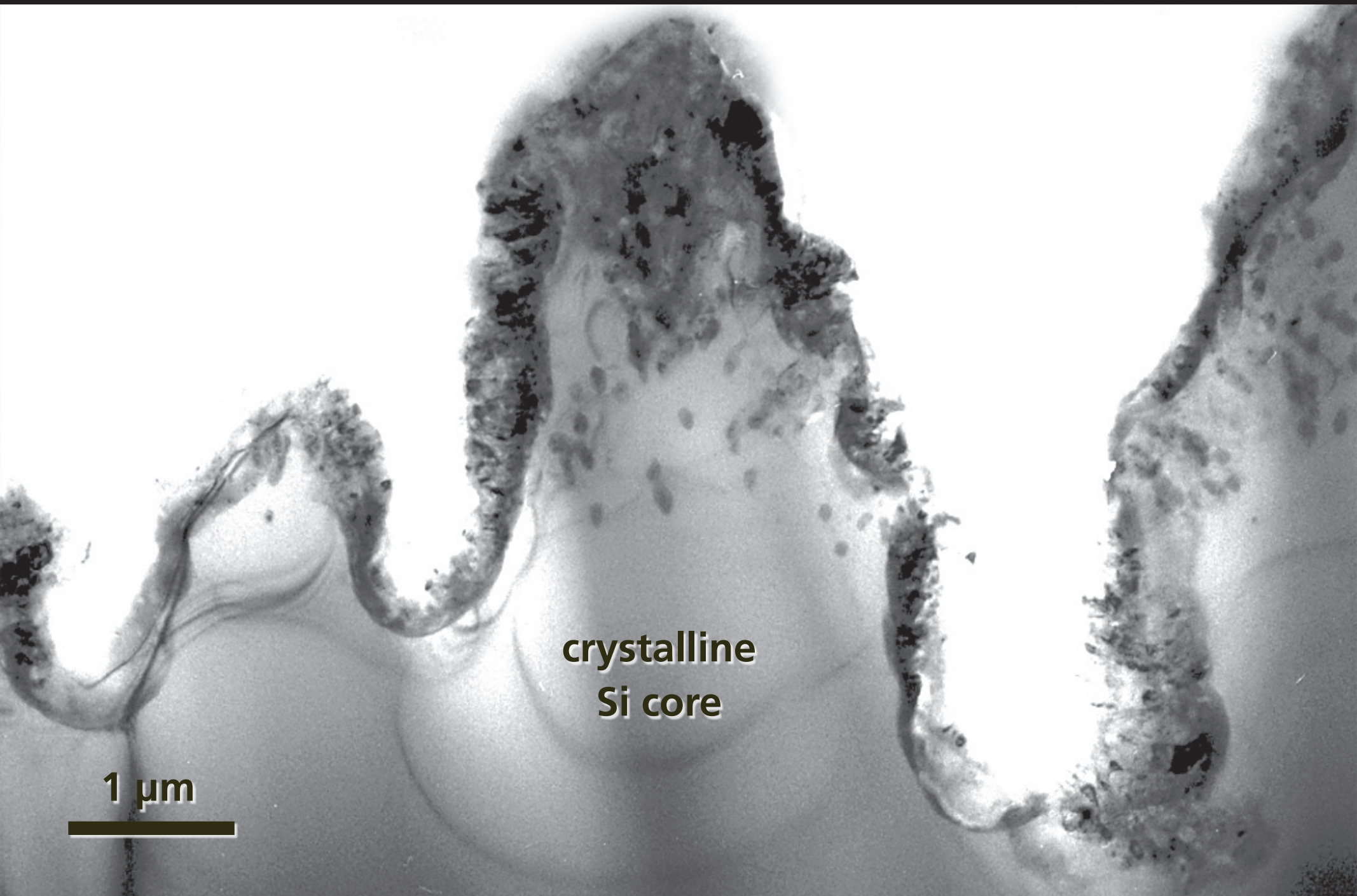

crystalline
Si core

1 μm

Structure

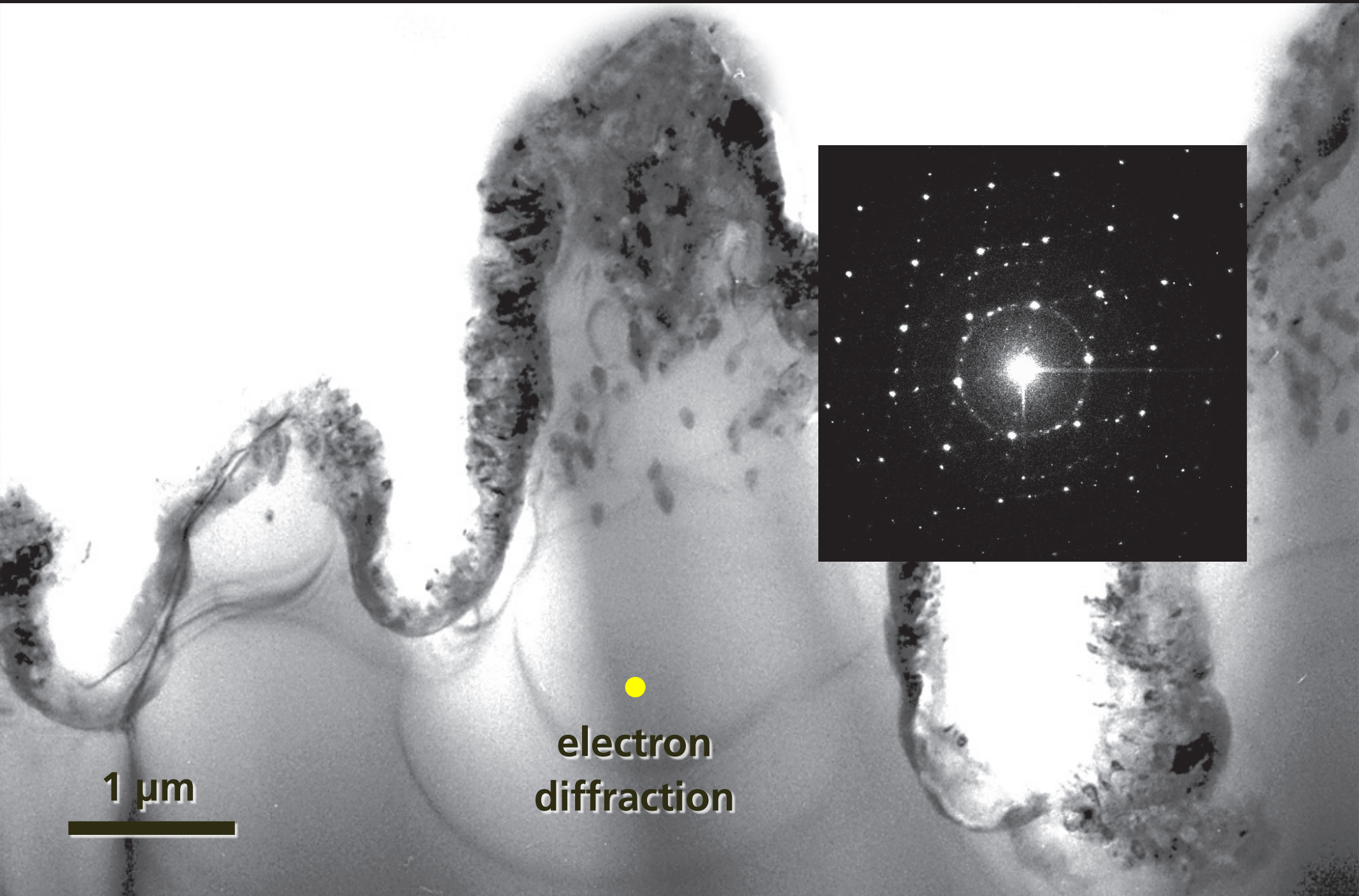

1 μm

●
electron
diffraction

Structure

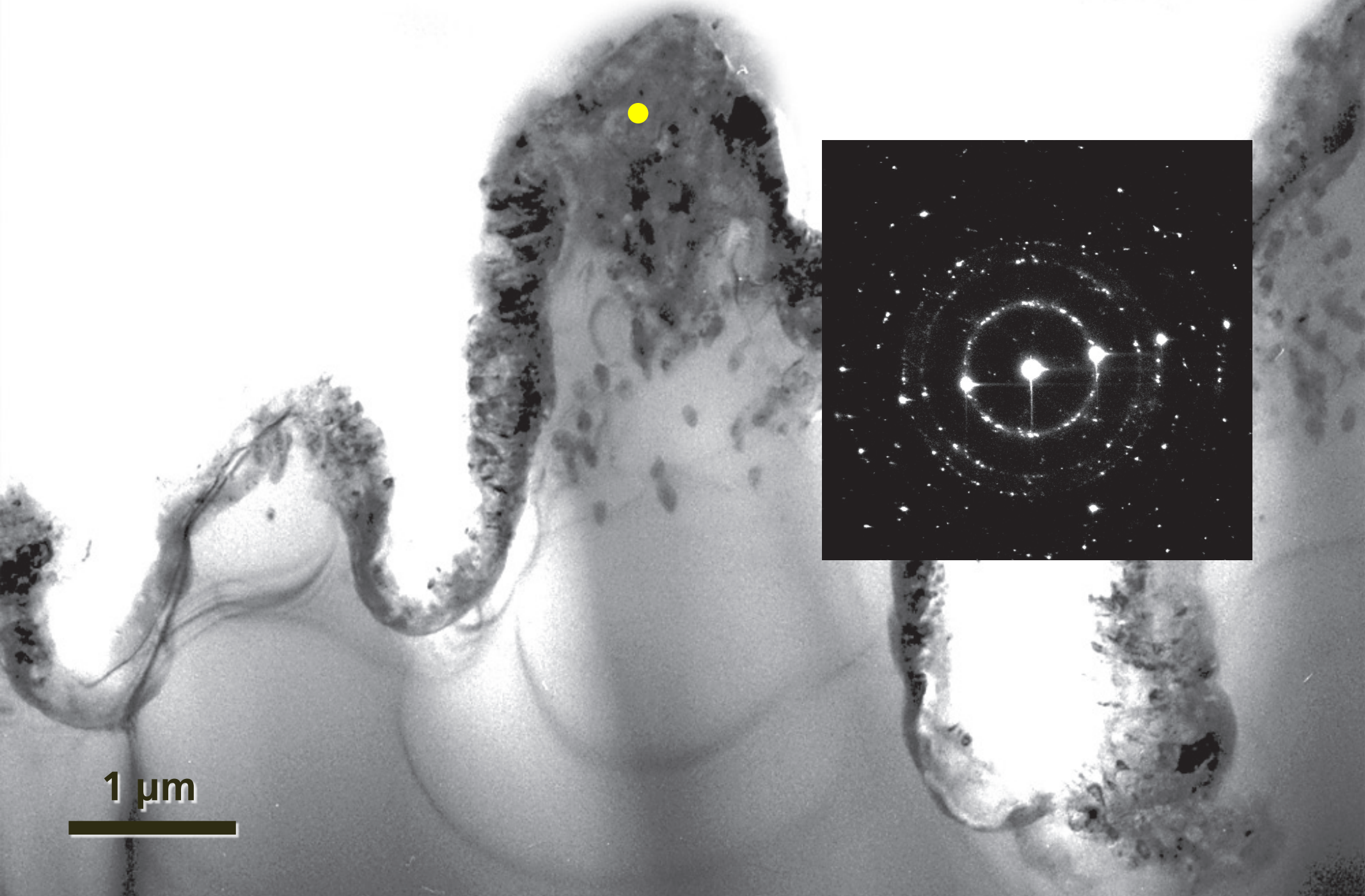

Structure

- 300-nm disordered surface layer
- undisturbed crystalline core
- surface layer: nanocrystalline Si with 1.6% sulfur

1 μm

A grayscale micrograph showing several elongated, finger-like structures. Each structure has a darker, textured outer layer and a lighter, smoother inner core. The structures are interconnected and appear to be part of a larger network. A scale bar at the bottom left indicates a length of 1 micrometer.

Structure

two processes: melting and ablation

Structure

relevant time scales

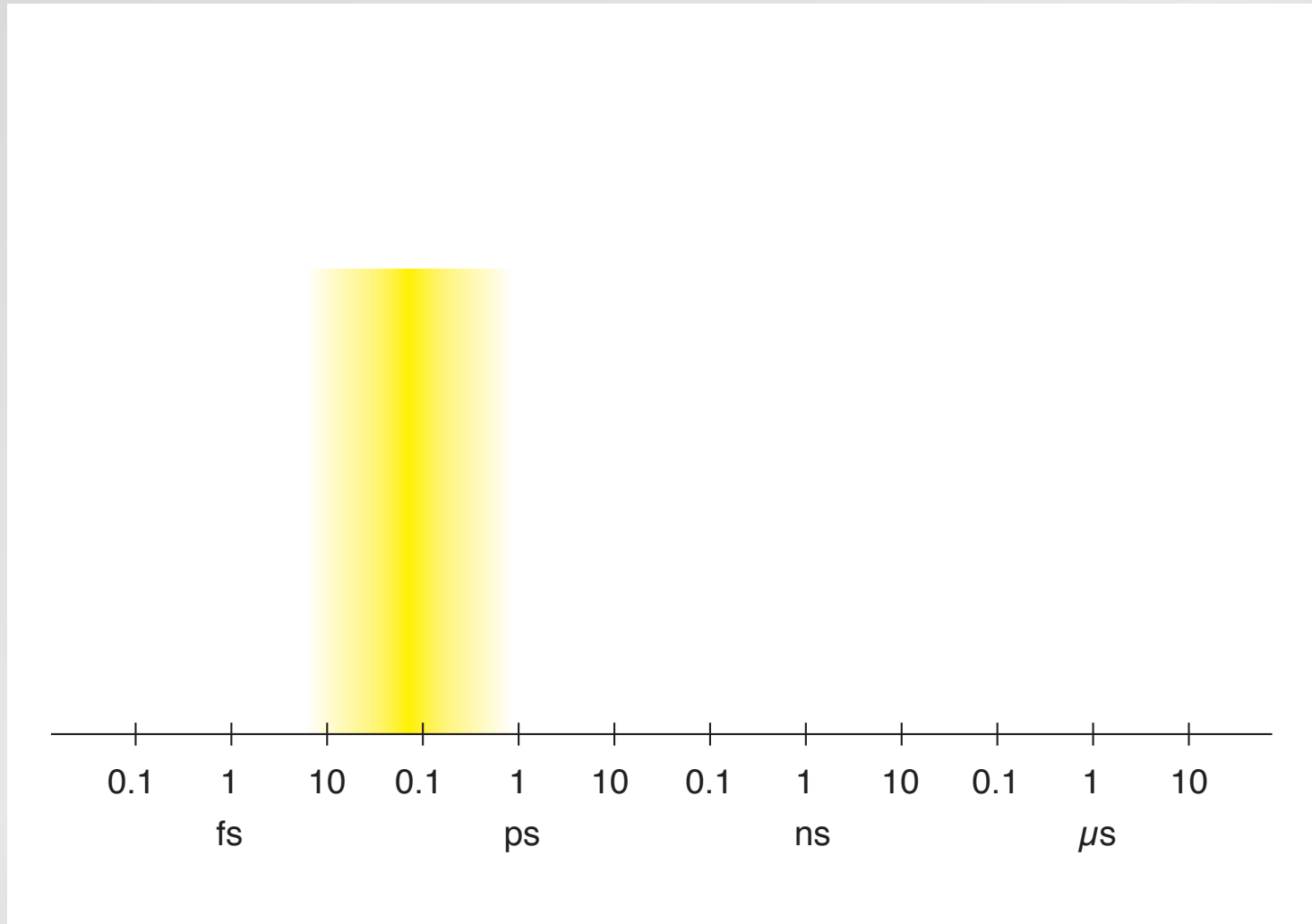

Structure

relevant time scales

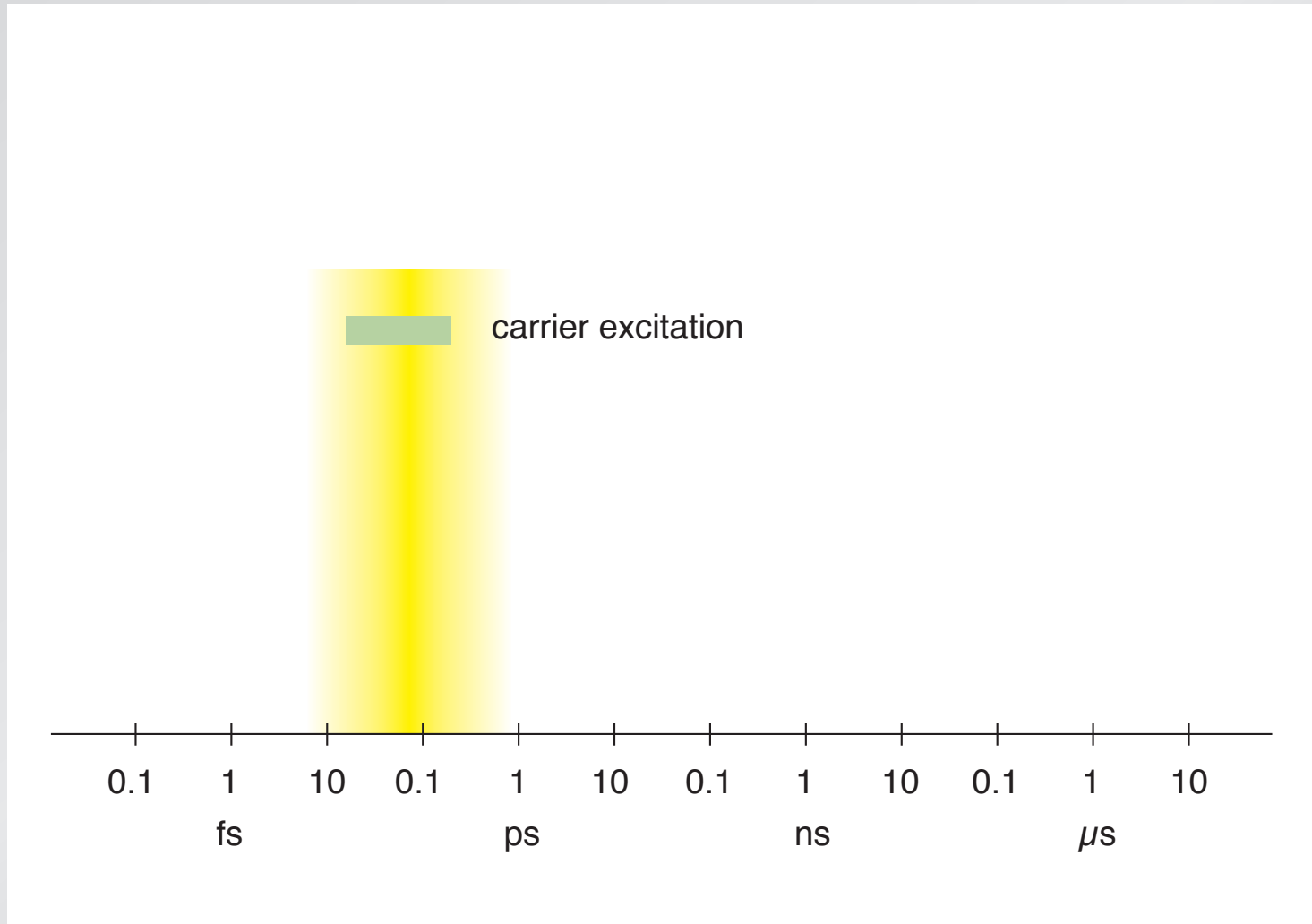

Structure

relevant time scales

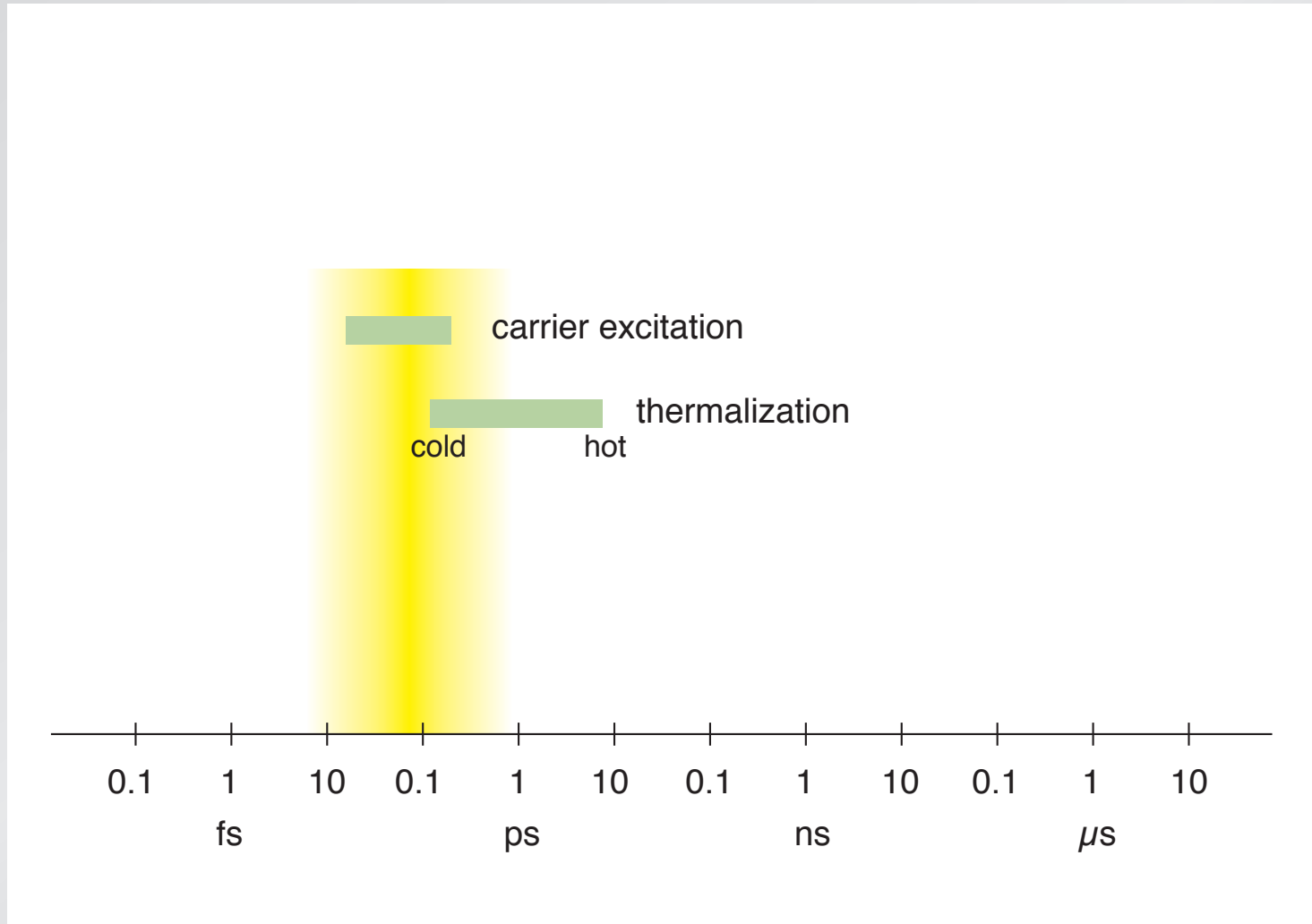

Structure

relevant time scales

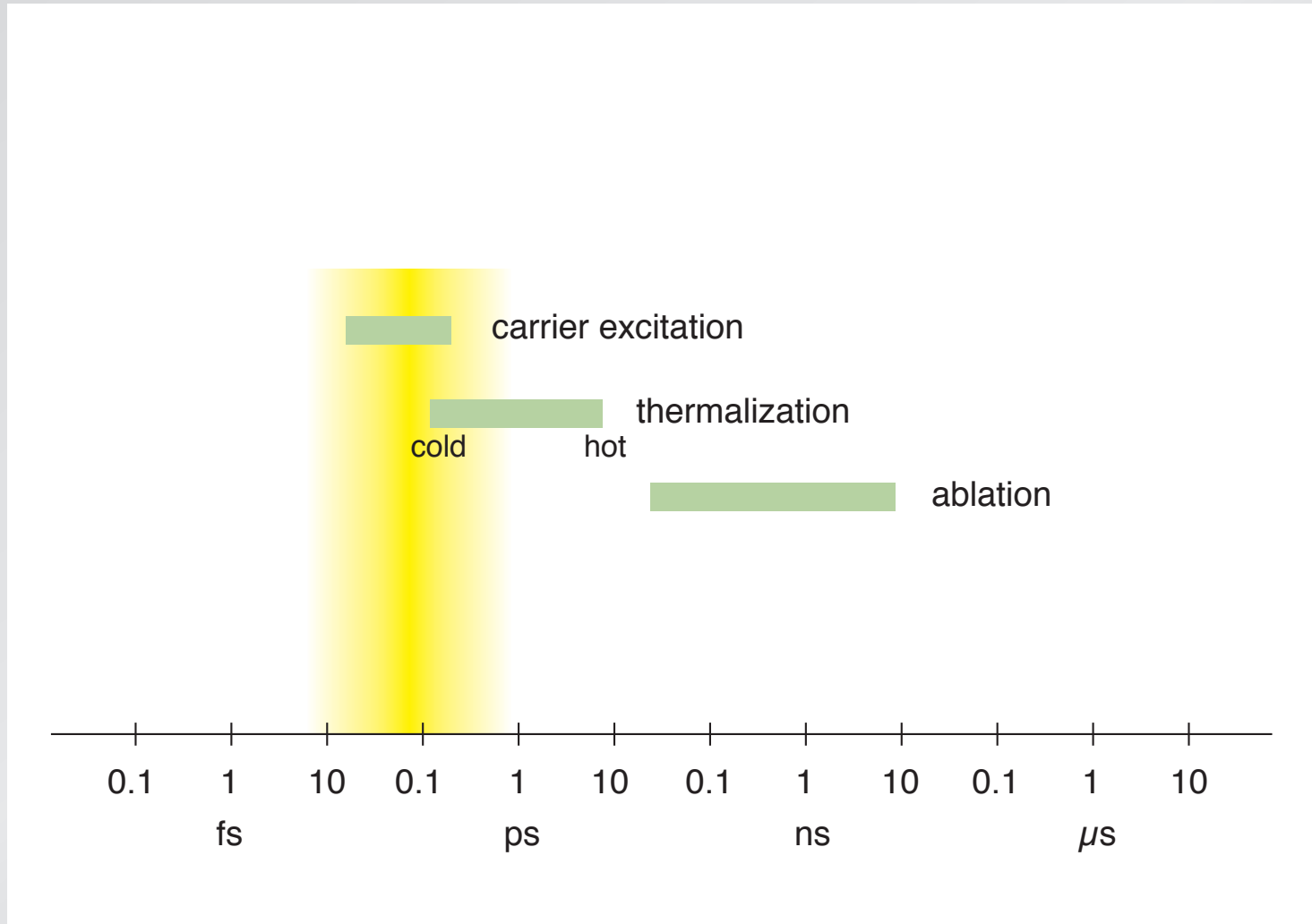

Structure

relevant time scales

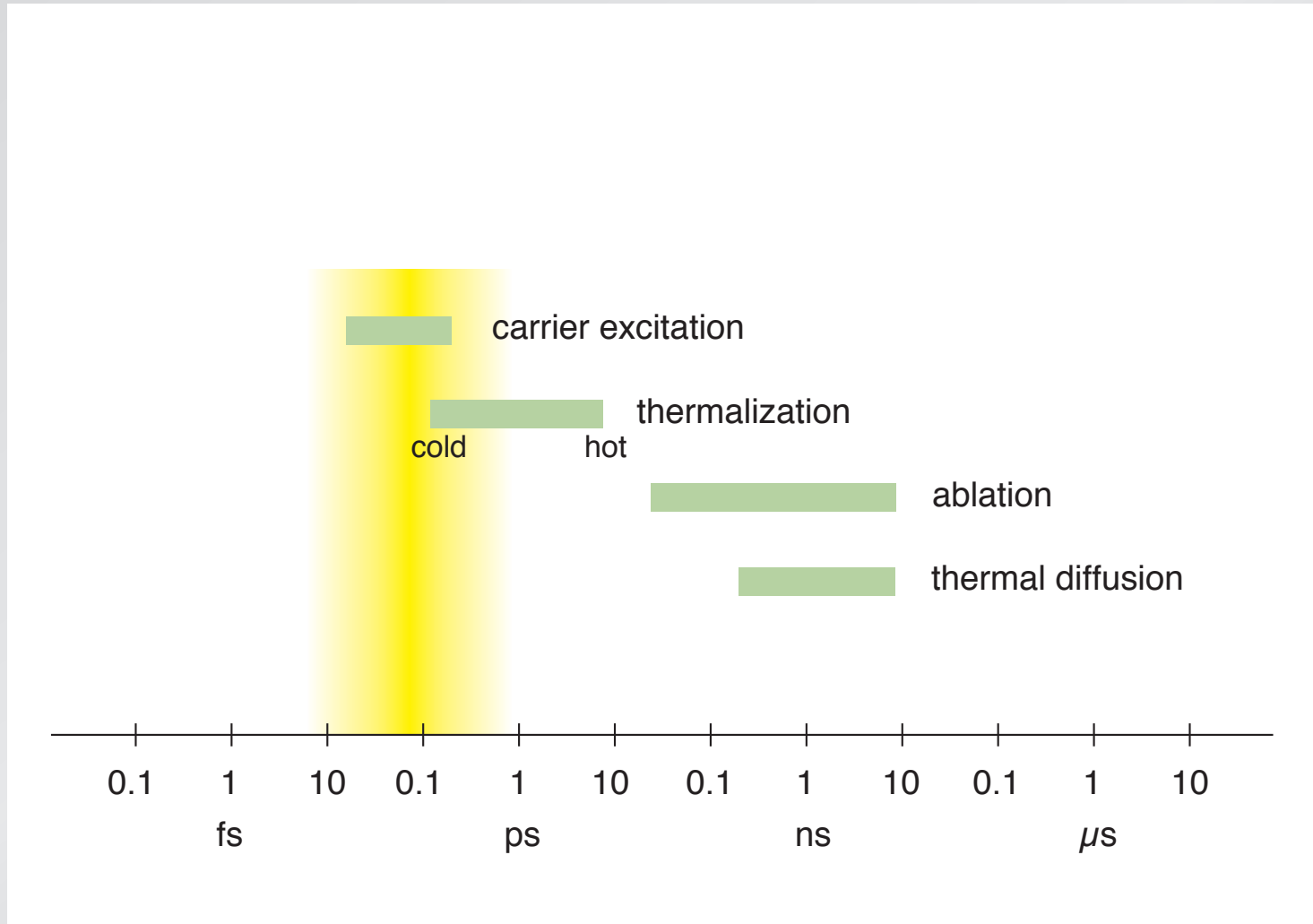

Structure

relevant time scales

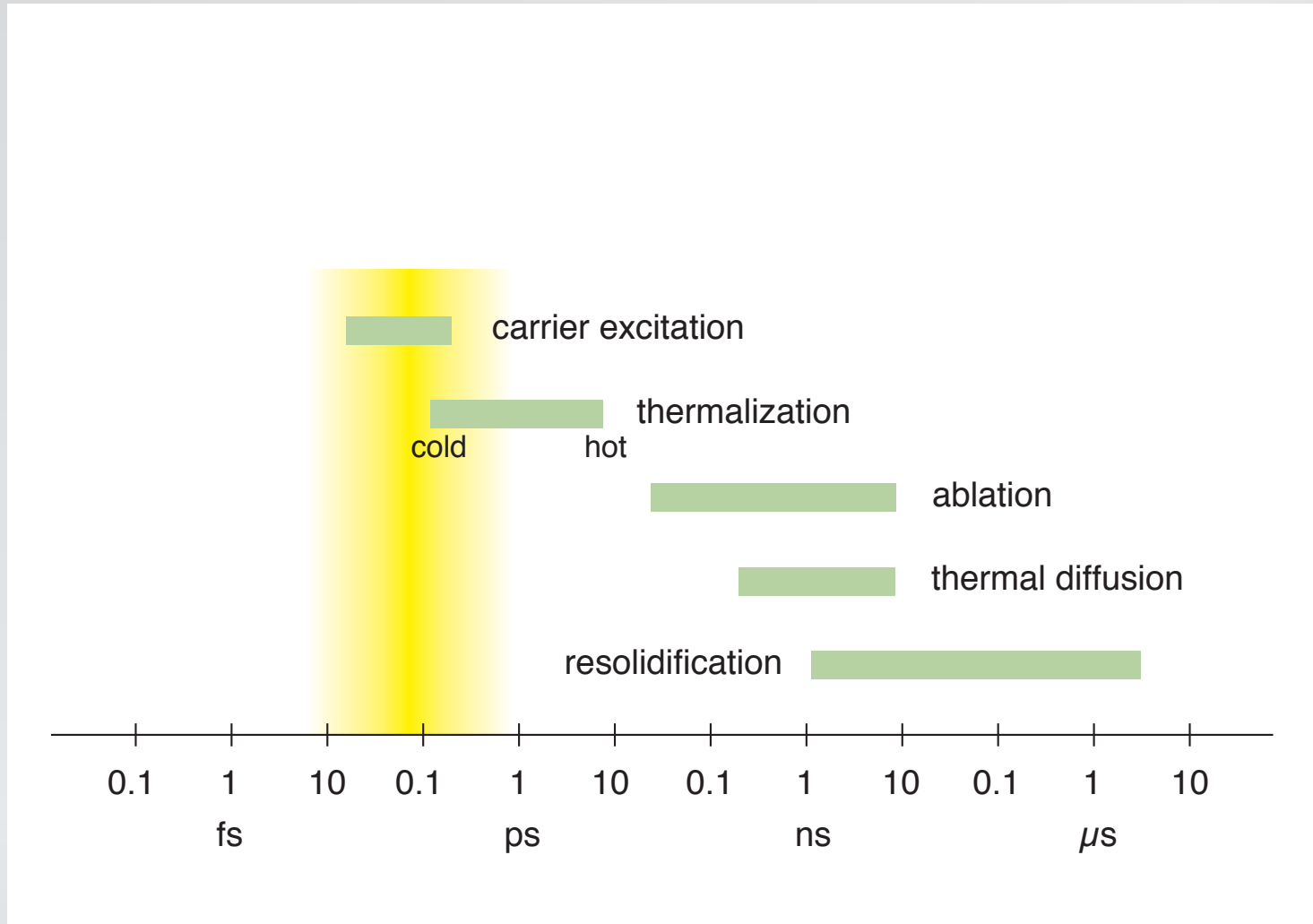

Structure

relevant time scales

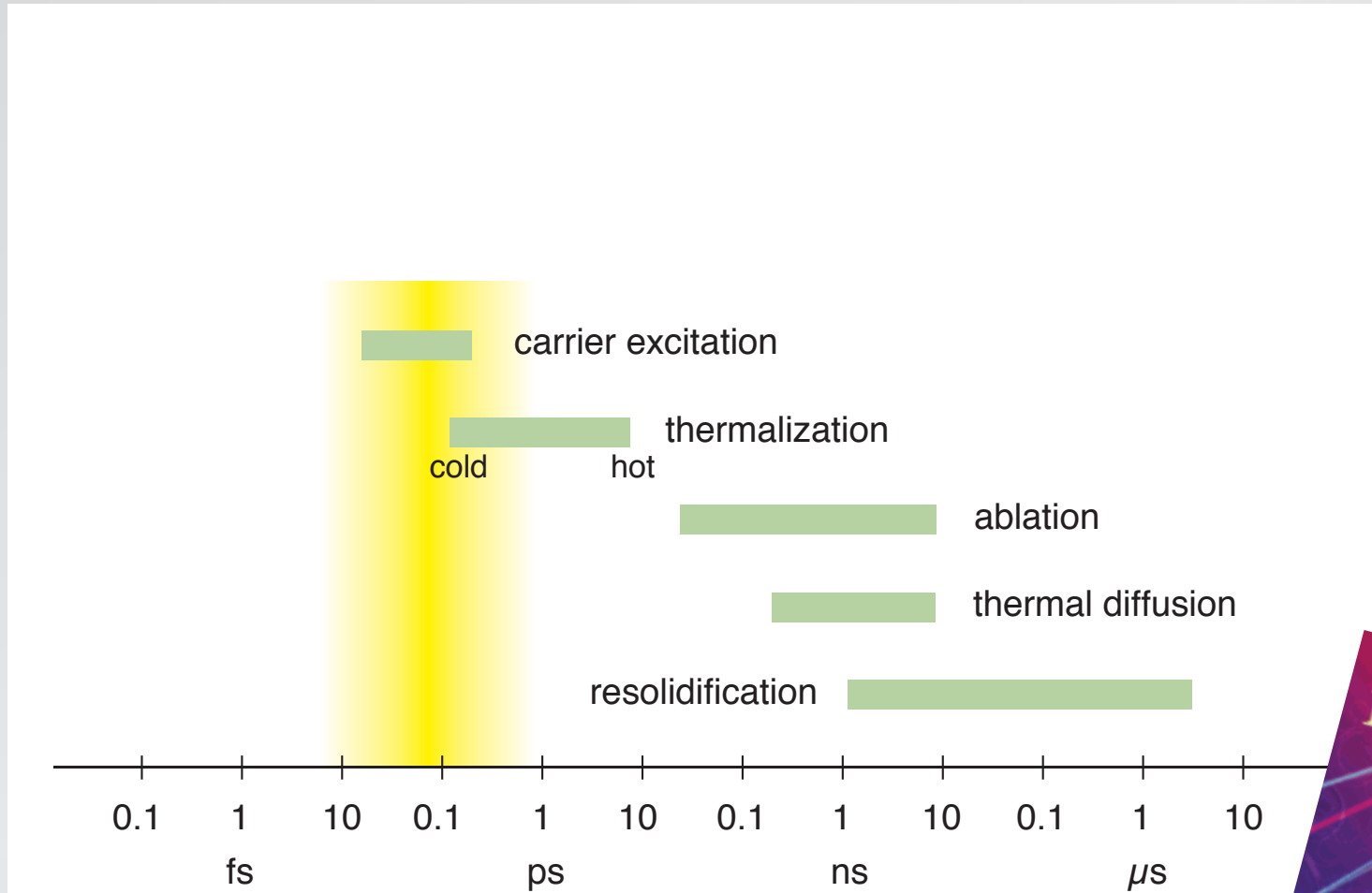

Nature Materials 1, 217 (2002)

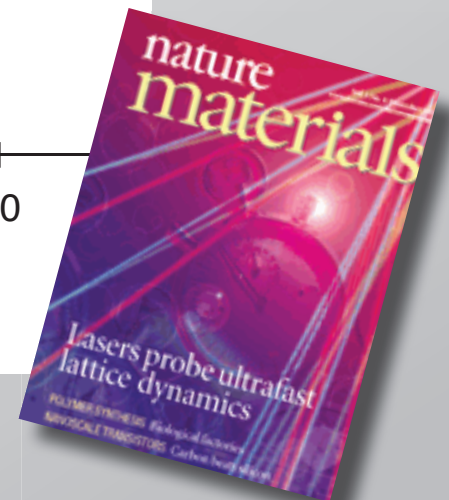

Structure

relevant time scales

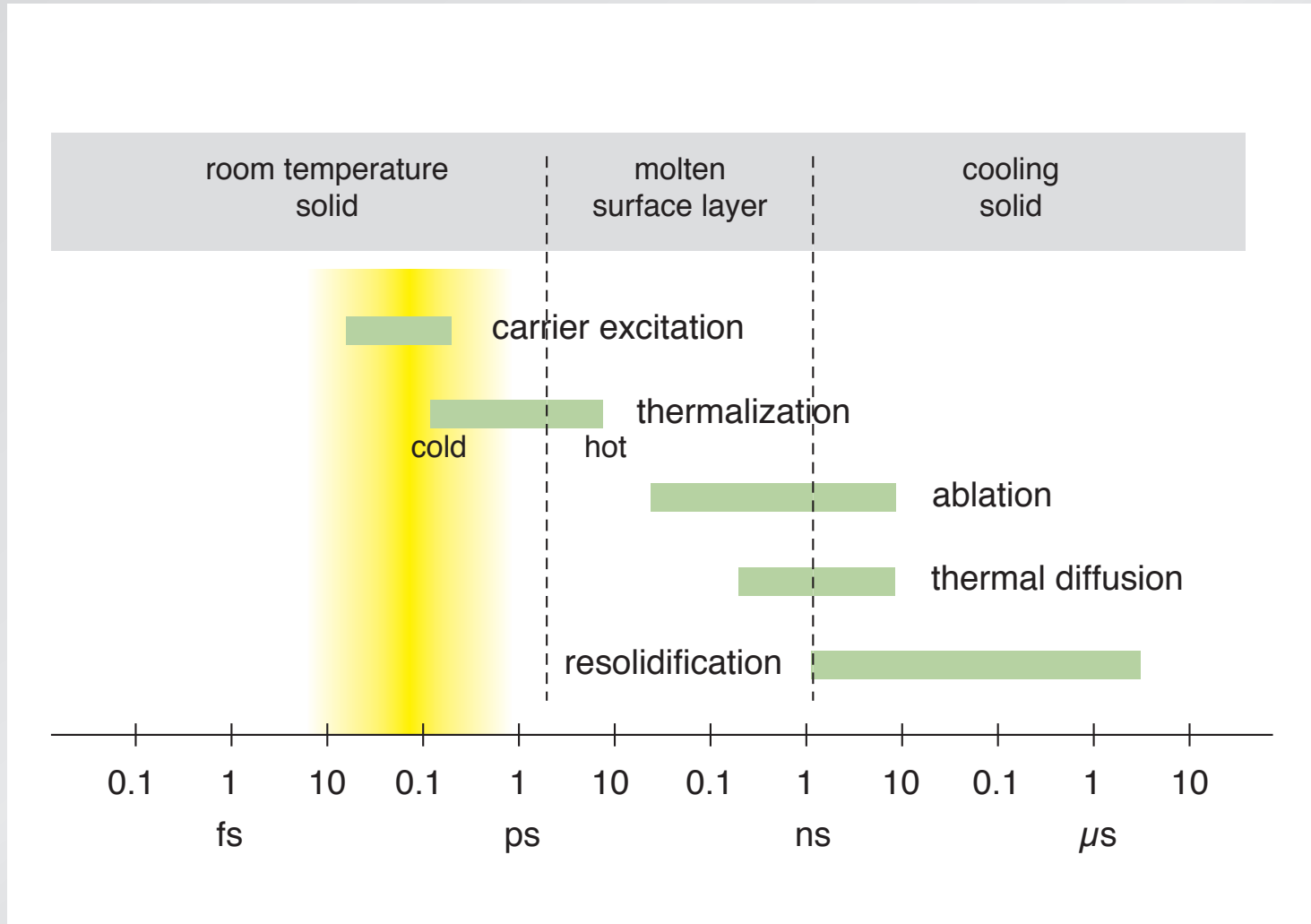

Structure

relevant time scales

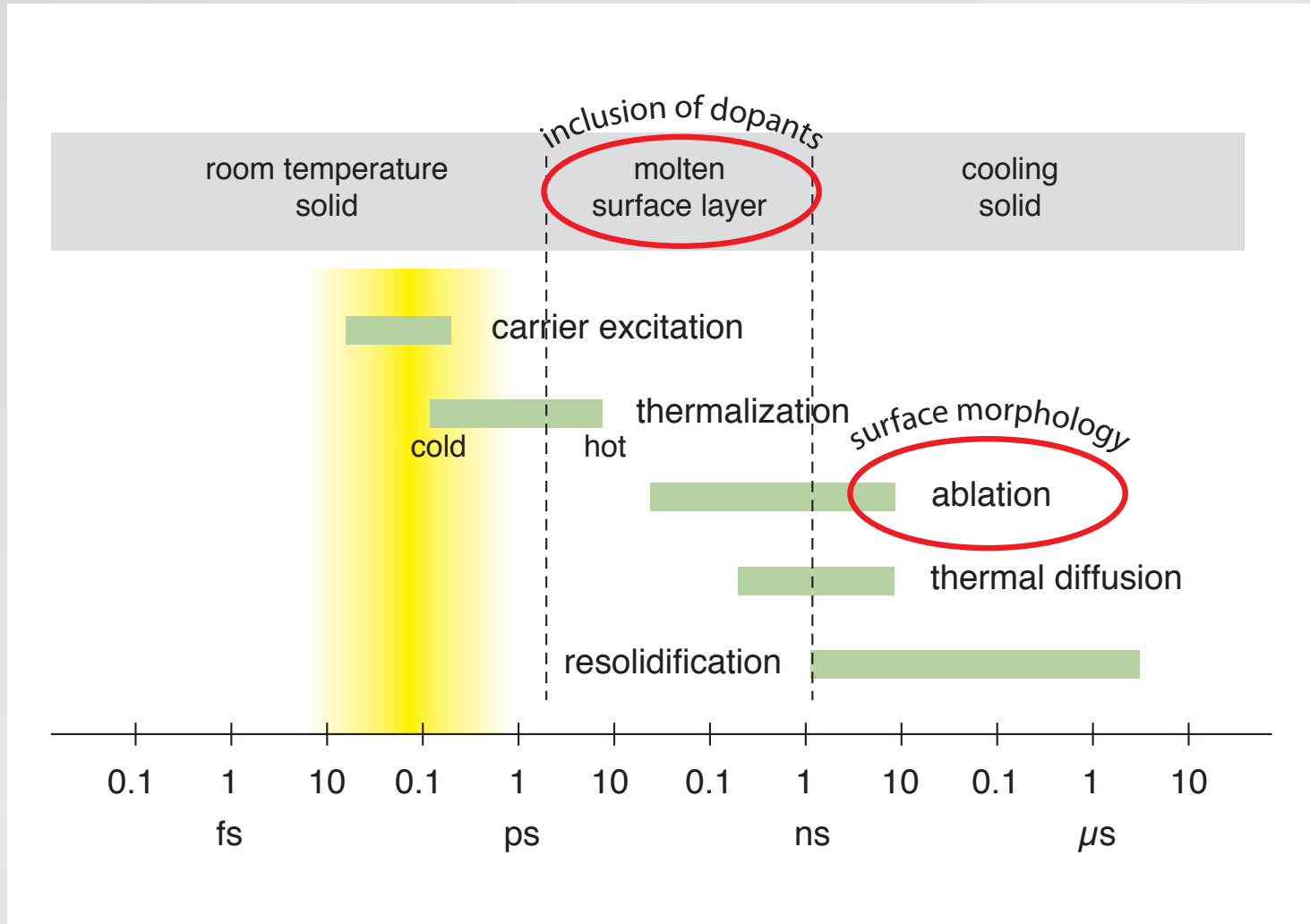

Structure

different thresholds:

melting: 1.5 kJ/m²

ablation: 3.1 kJ/m²

Structure

decouple ablation from melting

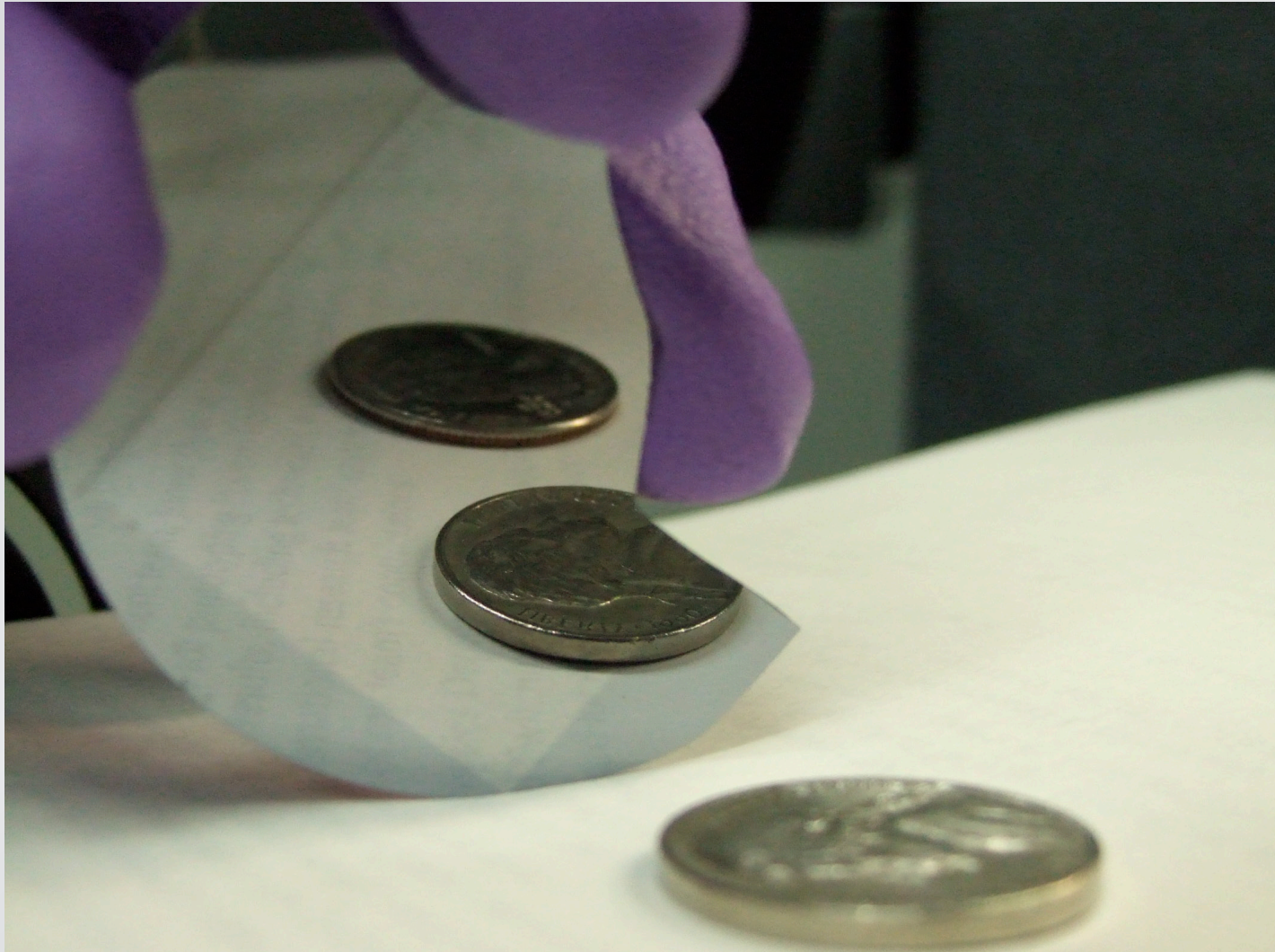

Structure

decouple ablation from melting

doped

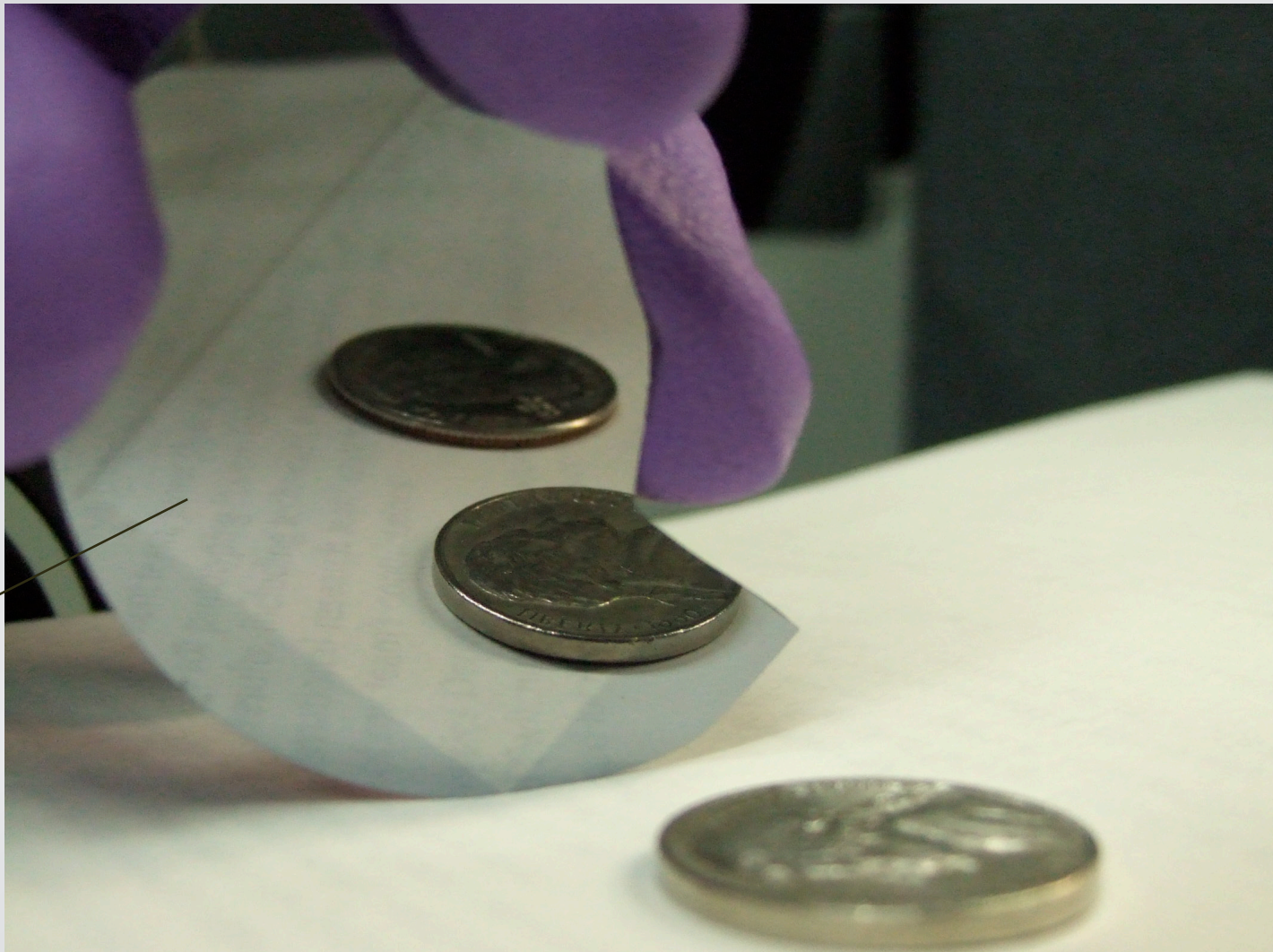

Structure

decouple ablation from melting

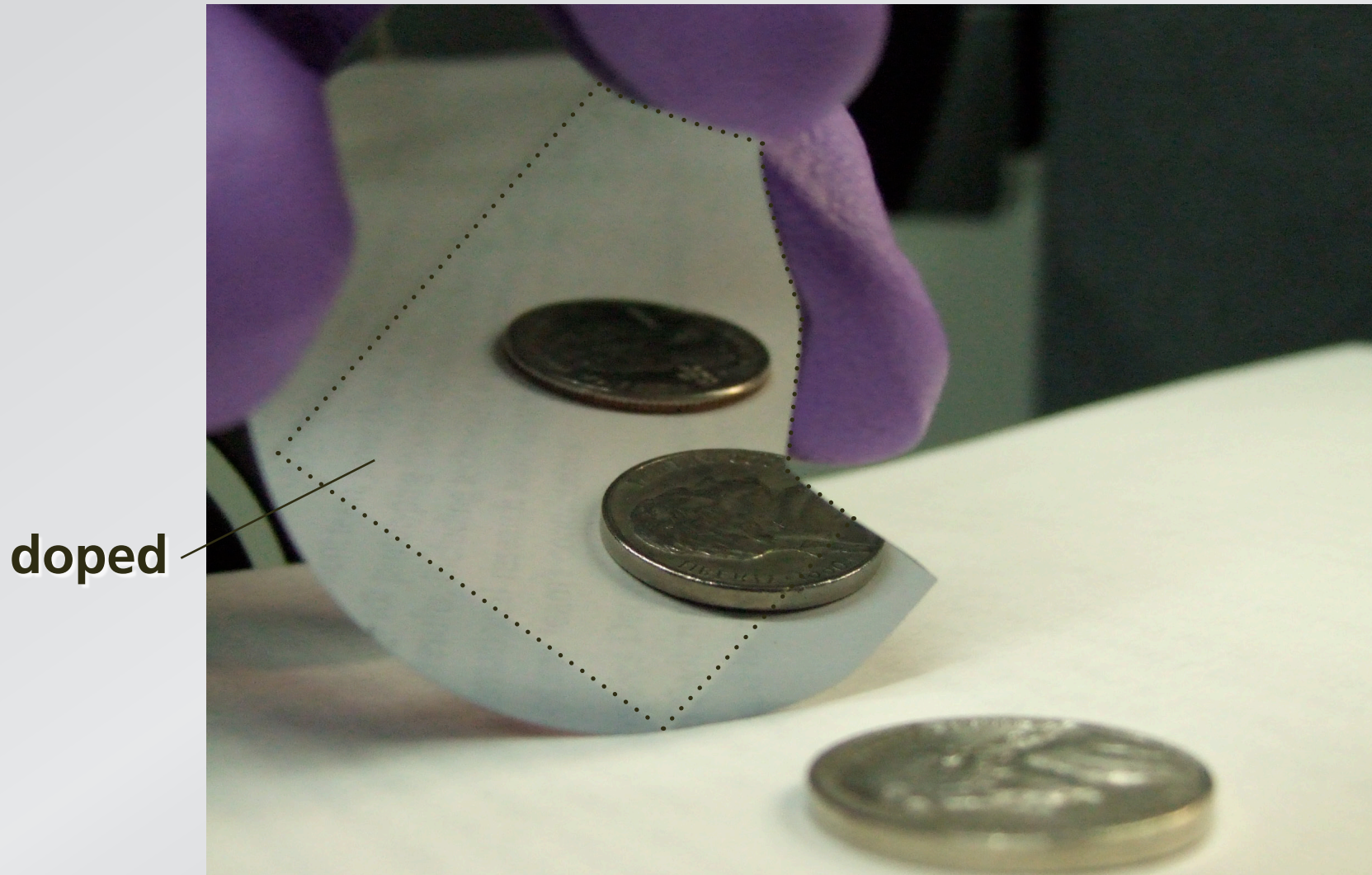

Structure

decouple ablation from melting

doped

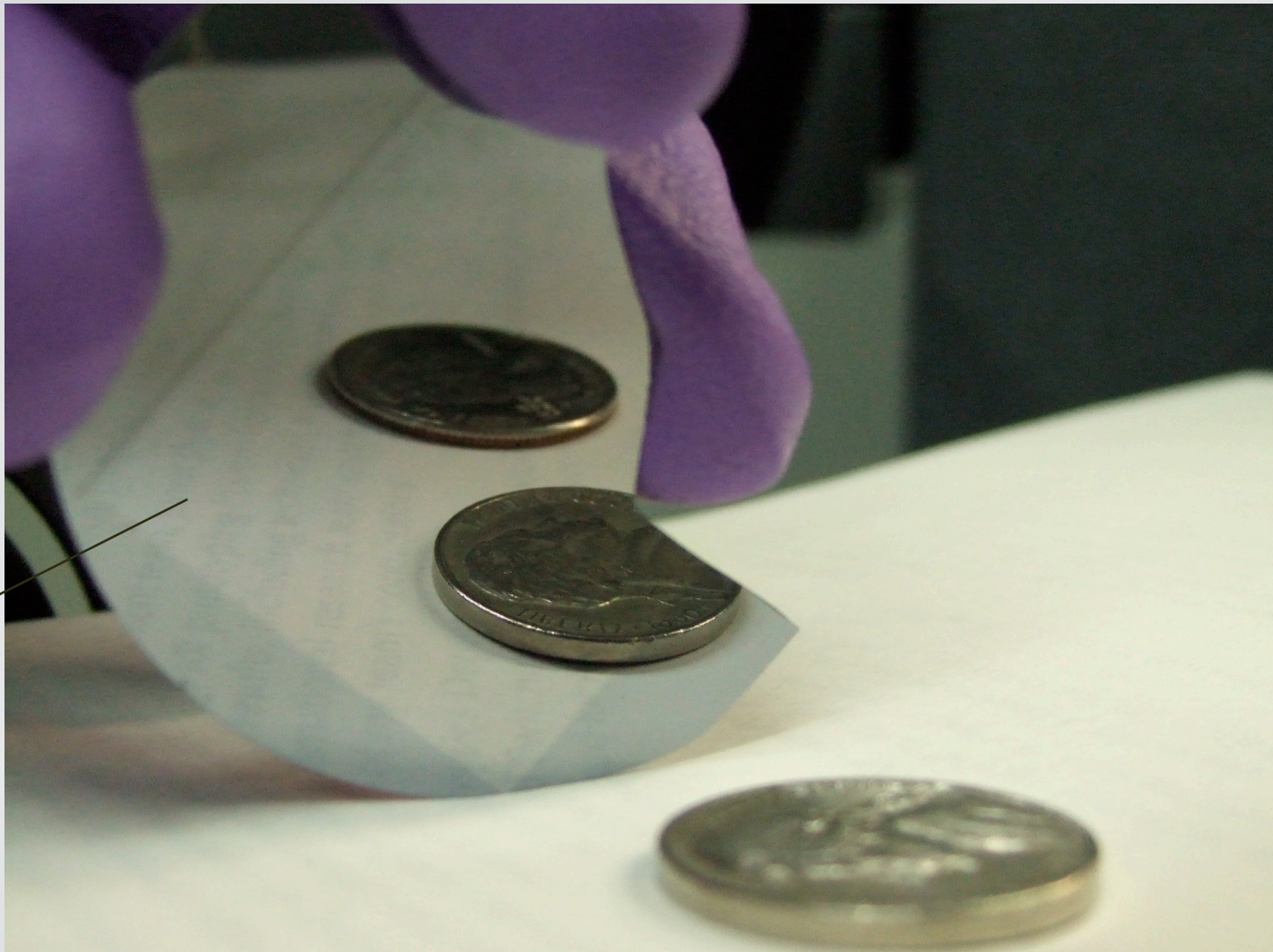

Structure

decouple ablation from melting

undoped

doped

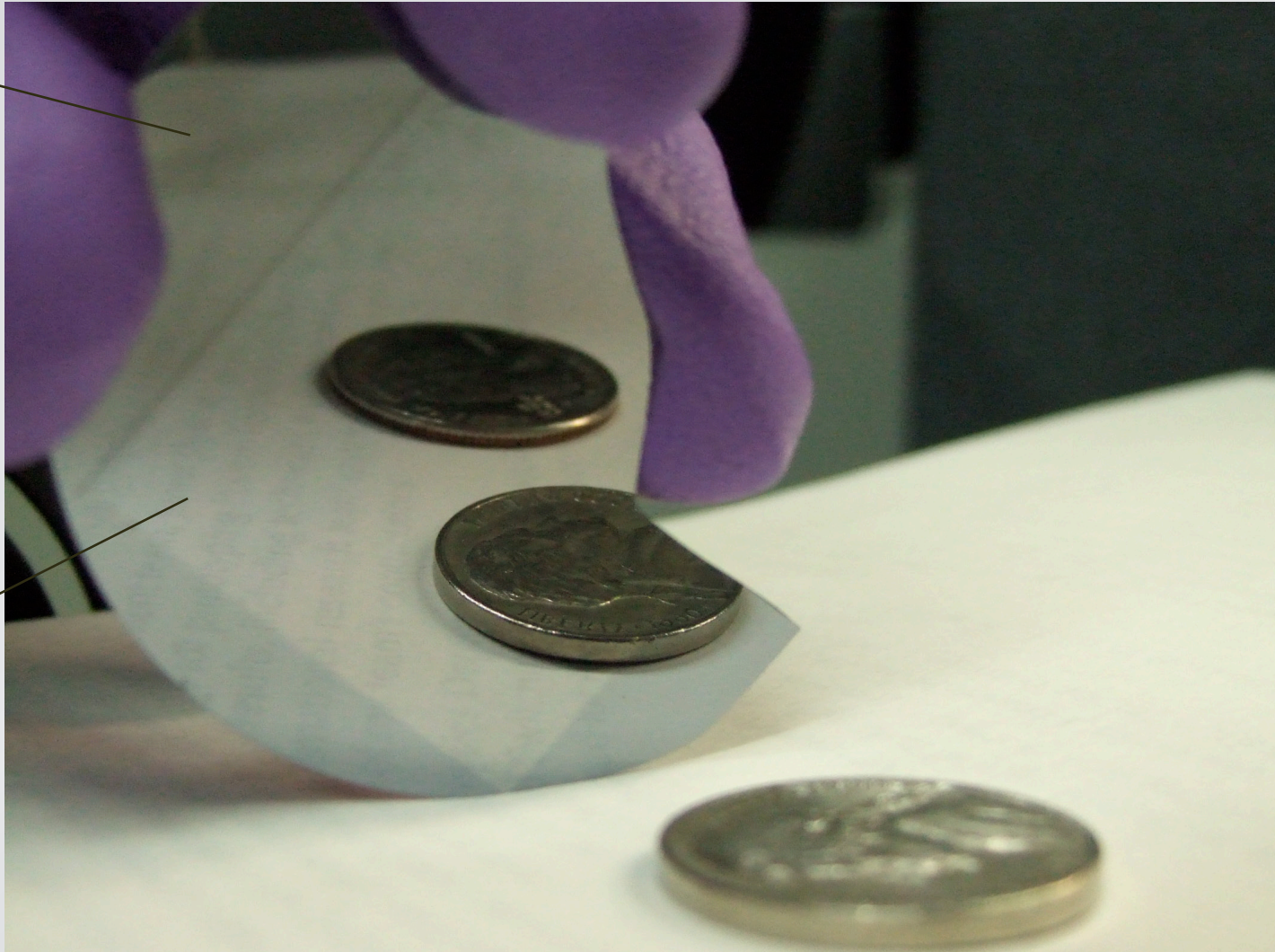

Structure

decouple ablation from melting

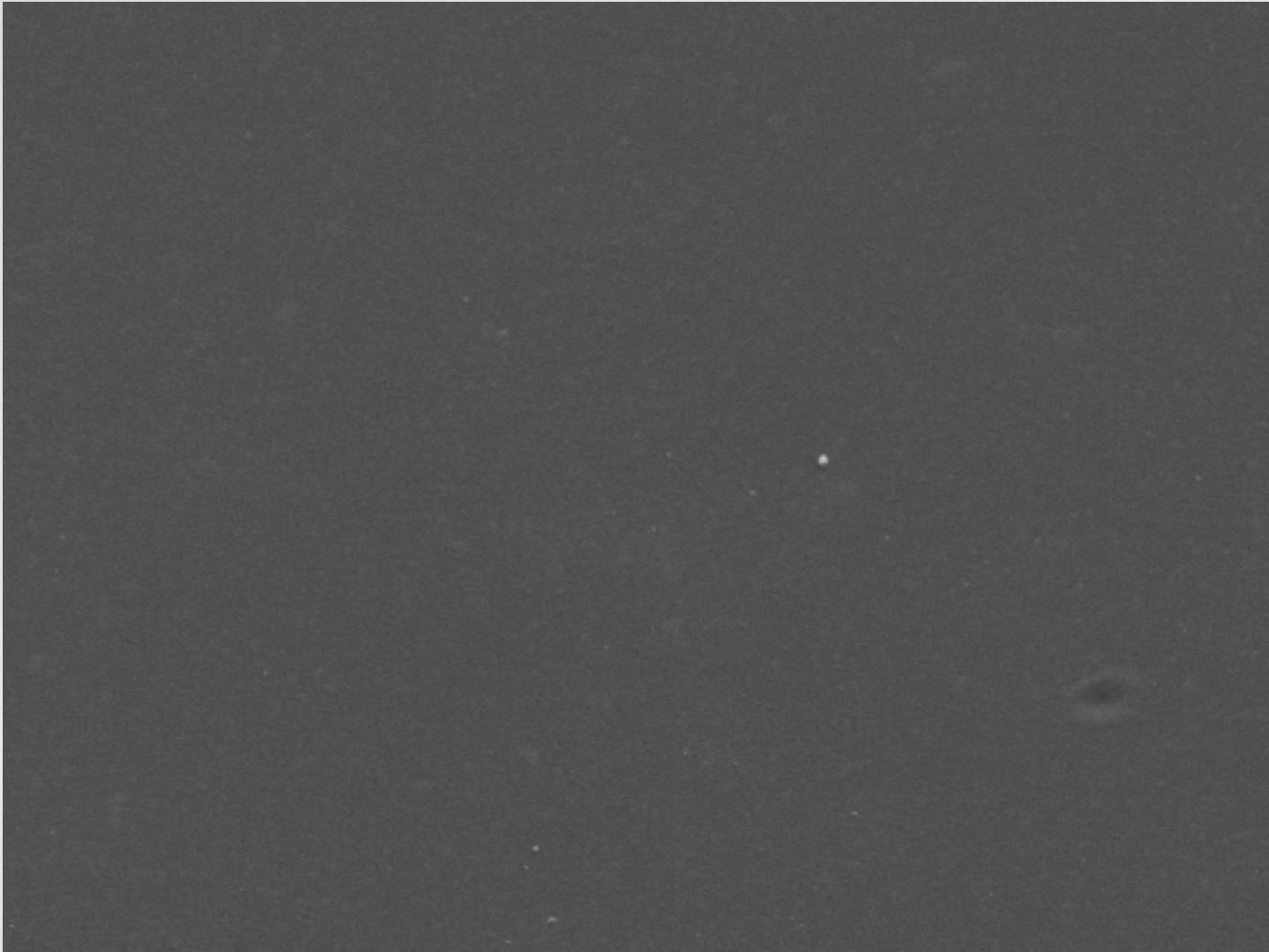

Structure

decouple ablation from melting

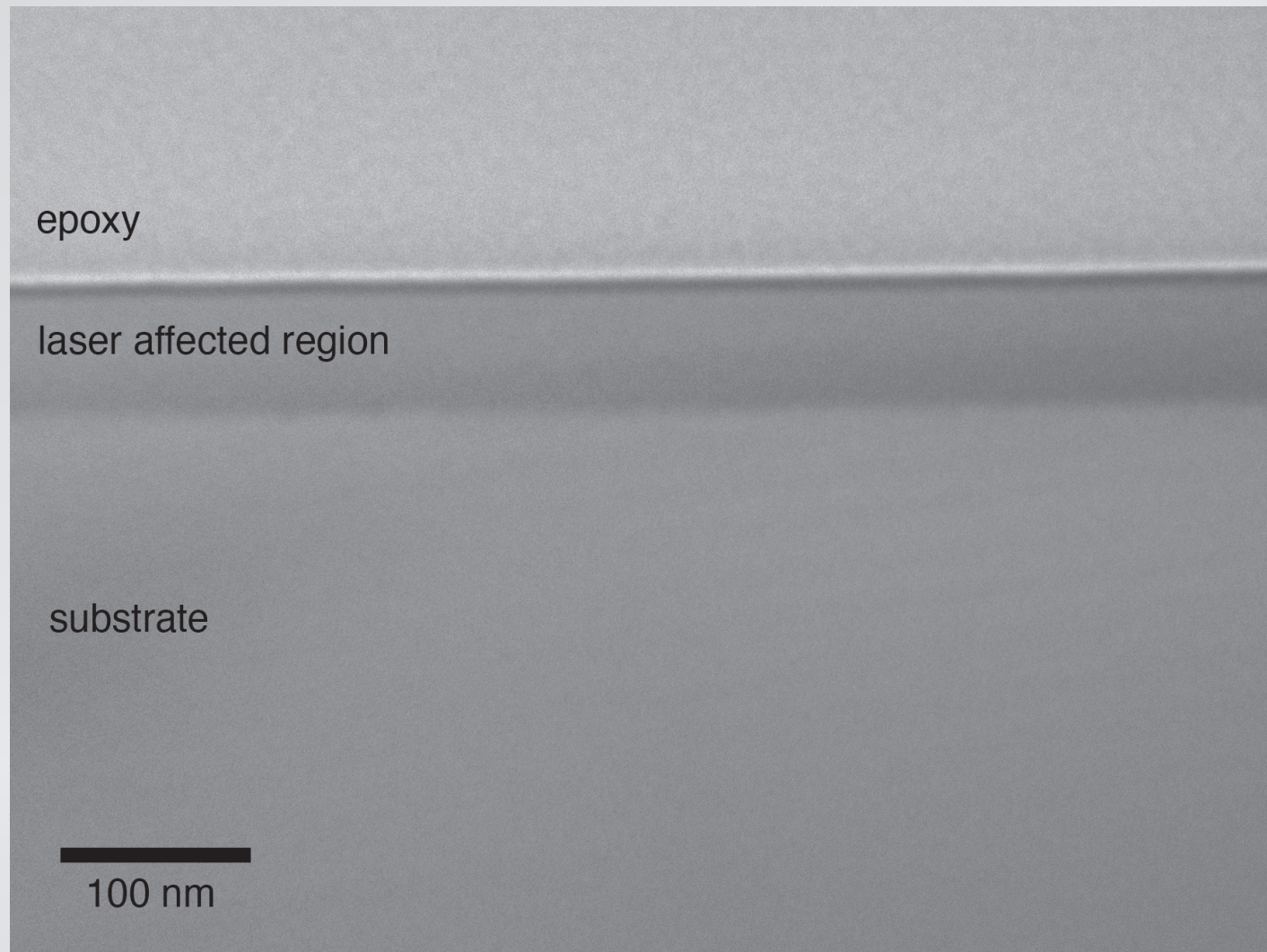

Structure

decouple ablation from melting

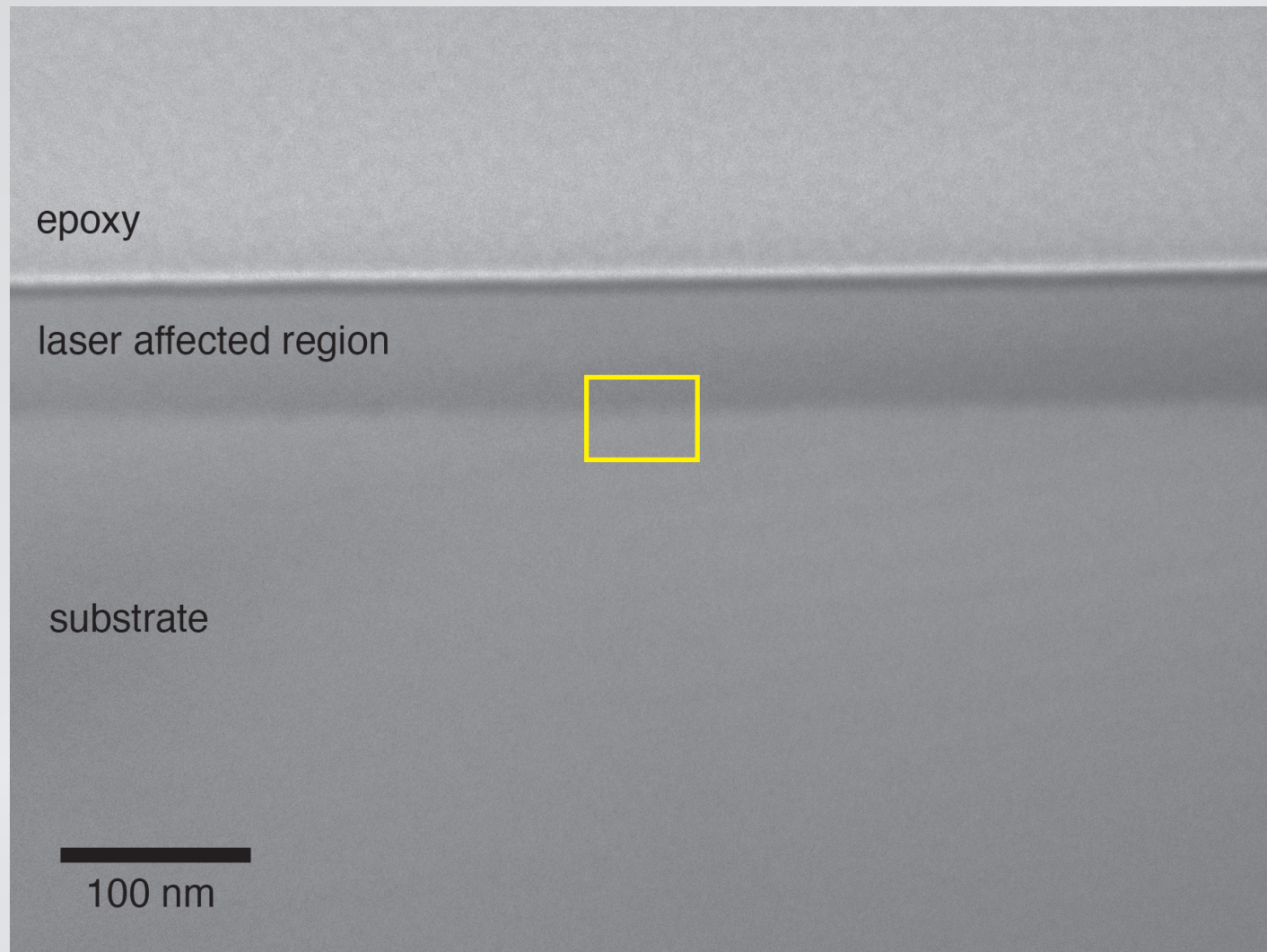

Structure

decouple ablation from melting

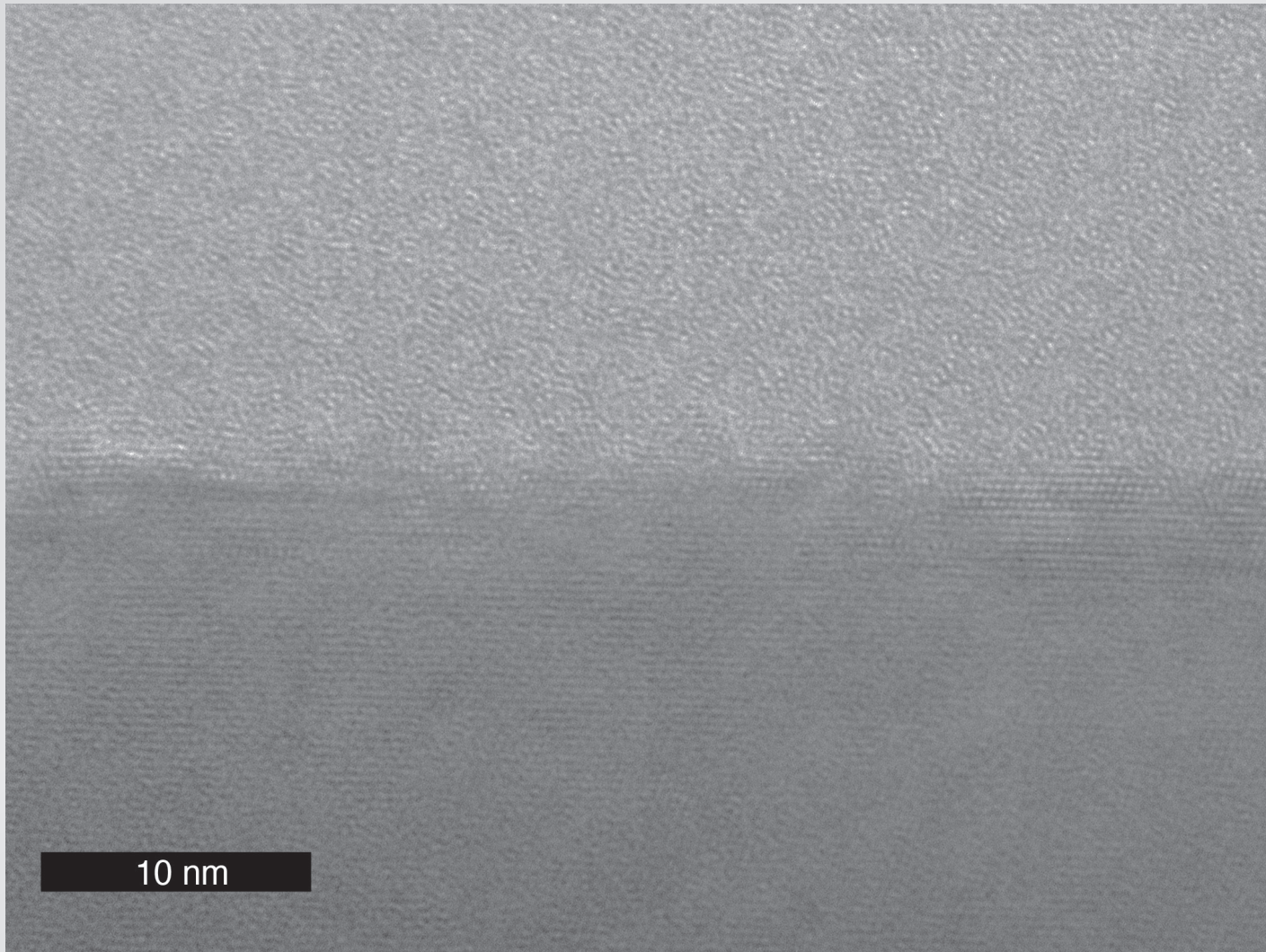

Structure

decouple ablation from melting

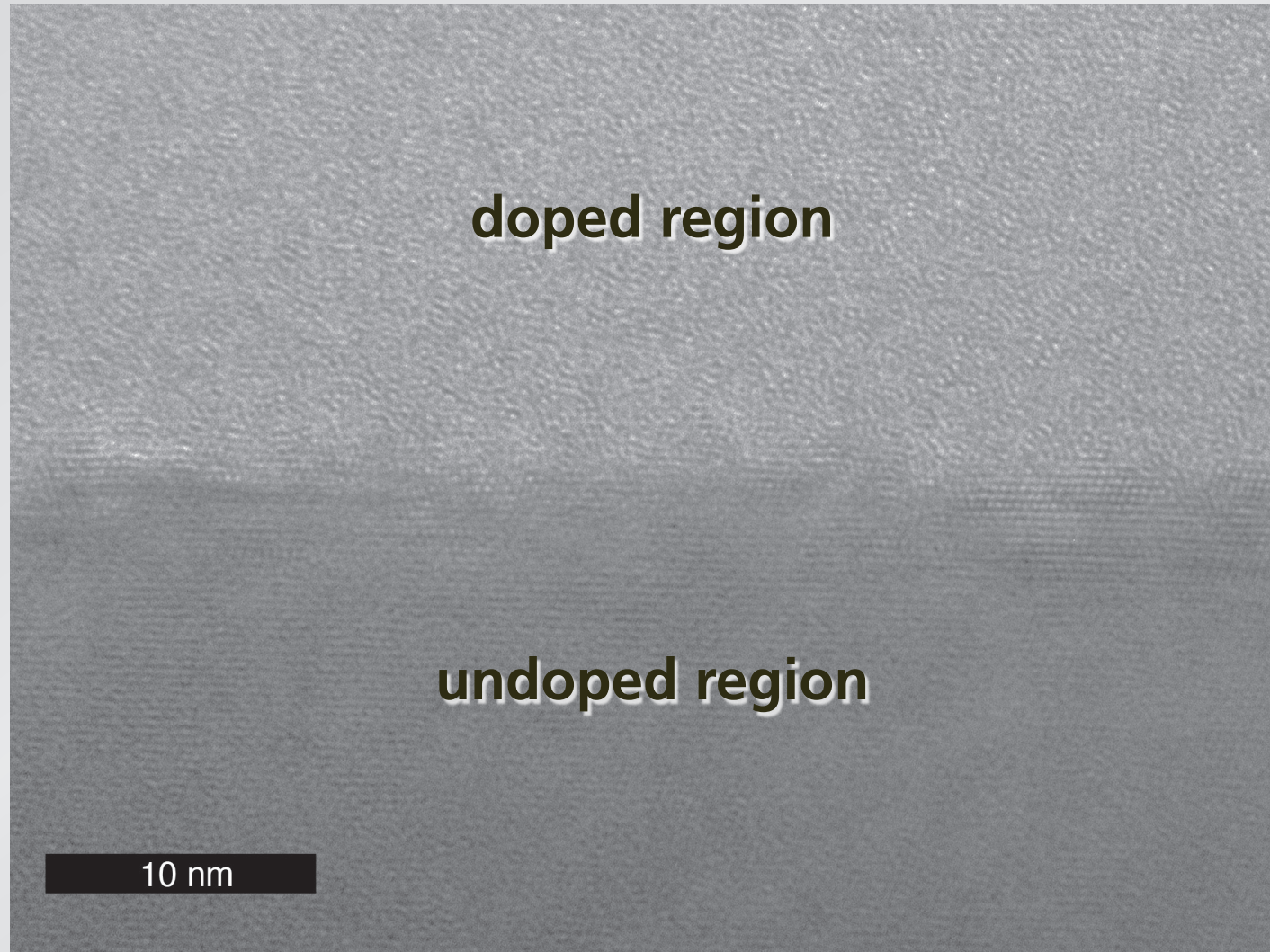

Structure

decouple ablation from melting

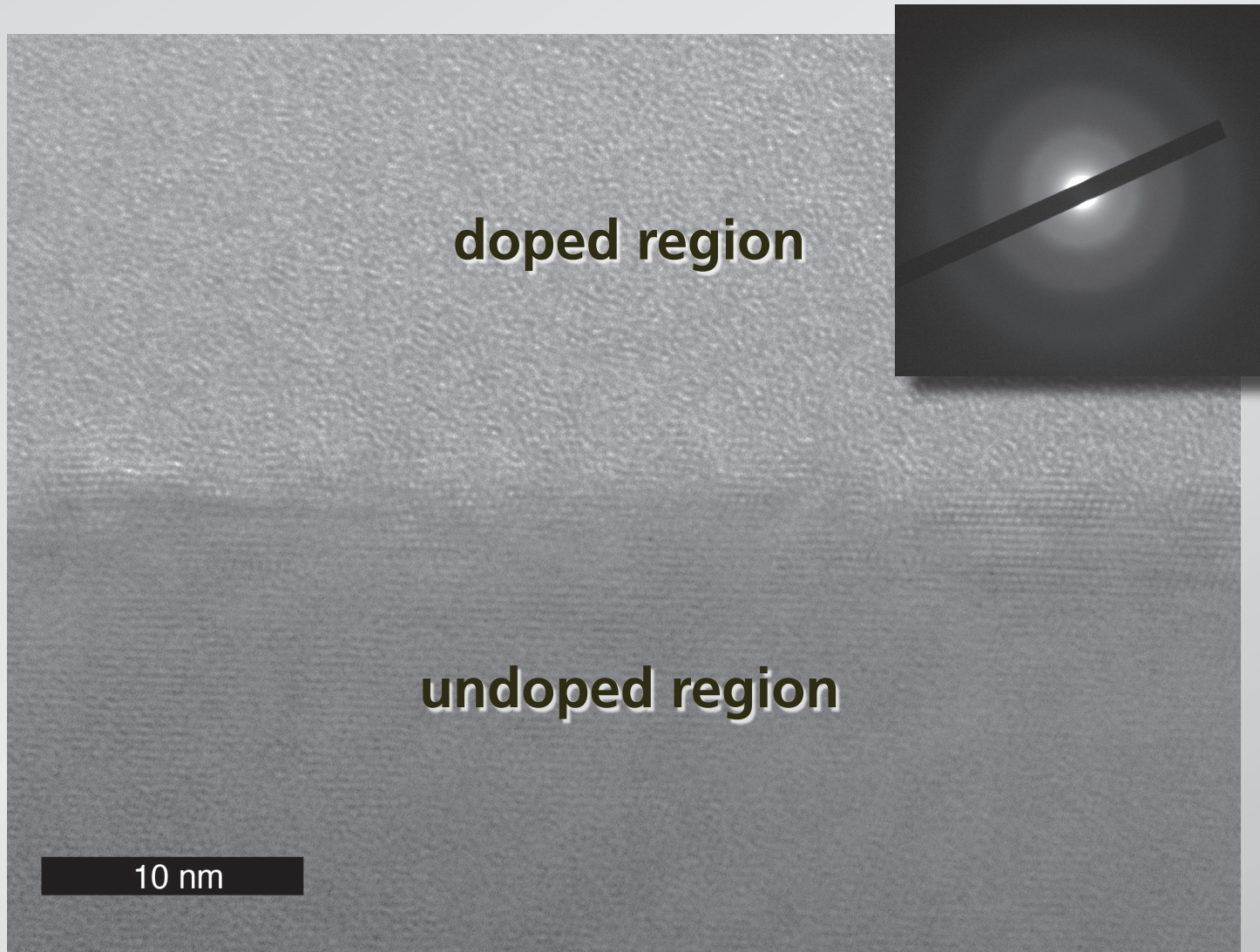

Structure

secondary ion mass spectrometry

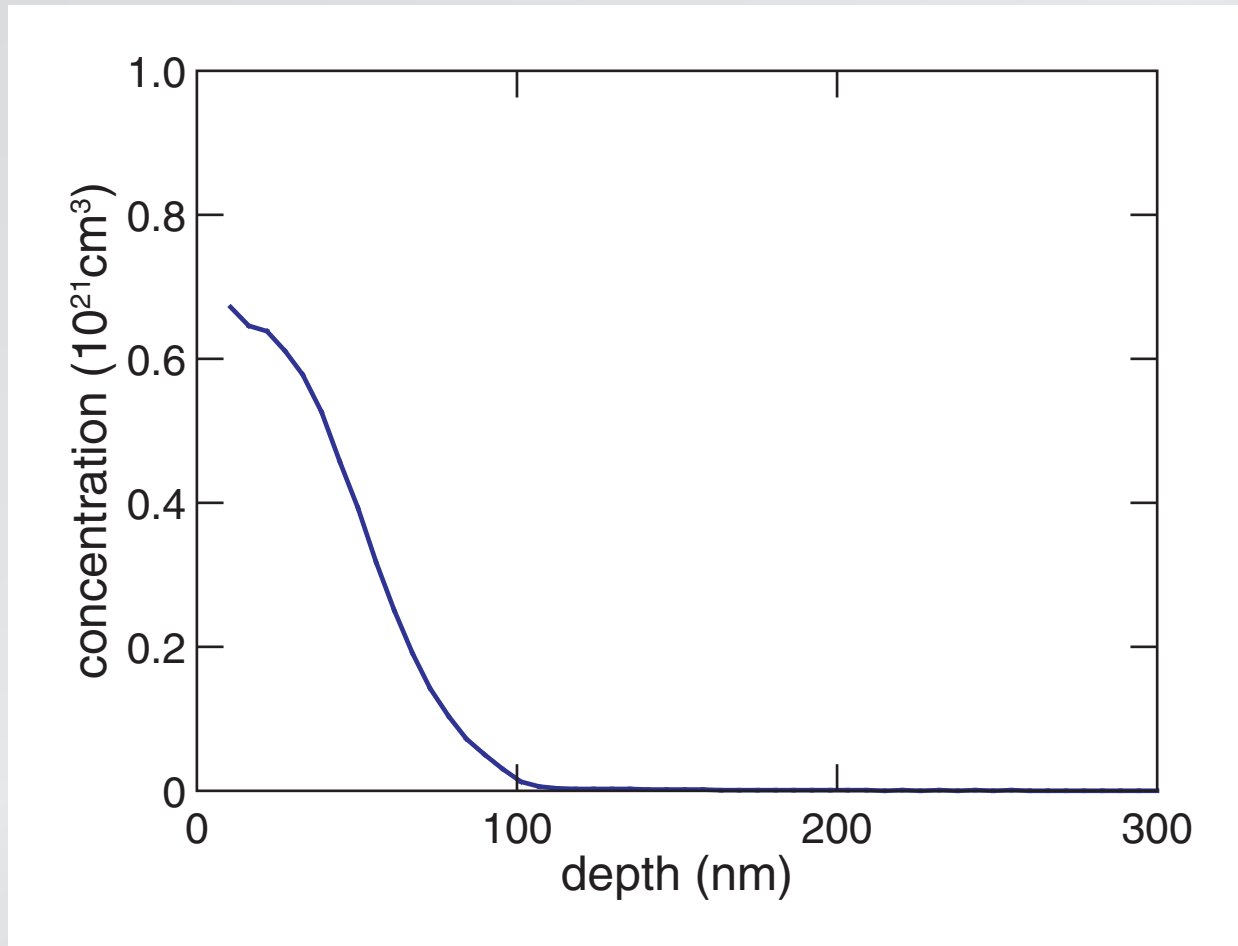

Structure

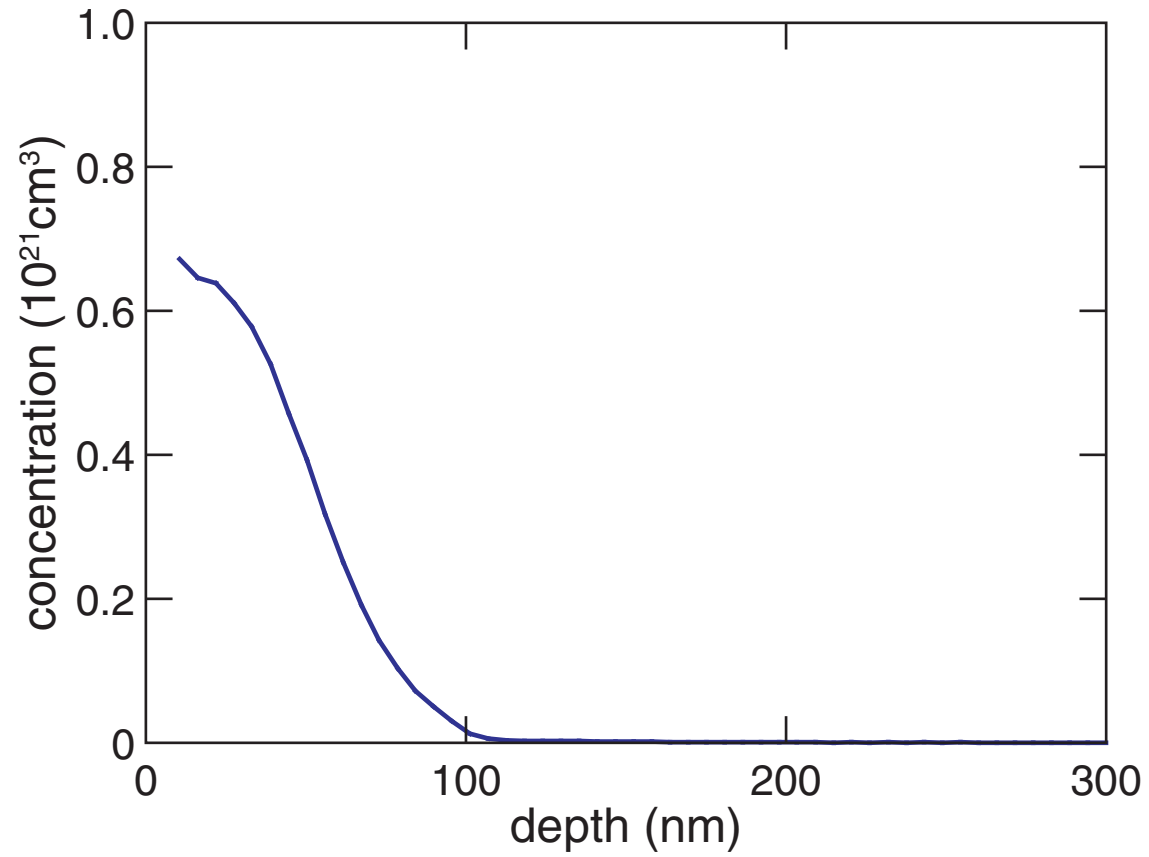
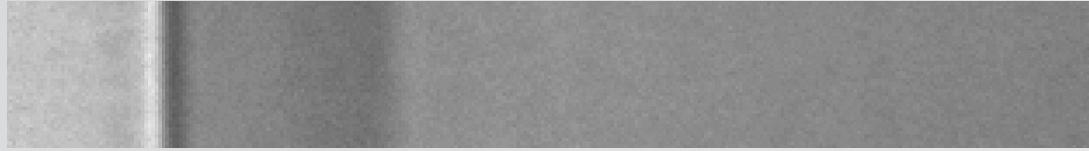

Structure

extended x-ray absorption fine structure spectrum:

dopant in two different chemical states

Structure

Things to keep in mind

- rapid melting and resolidification causes doping
- ablation causes morphology changes
- about 1% impurity in 100-nm thick surface layer
- annealing changes impurity coordination

Outline

- structure
- optoelectronic properties
- devices

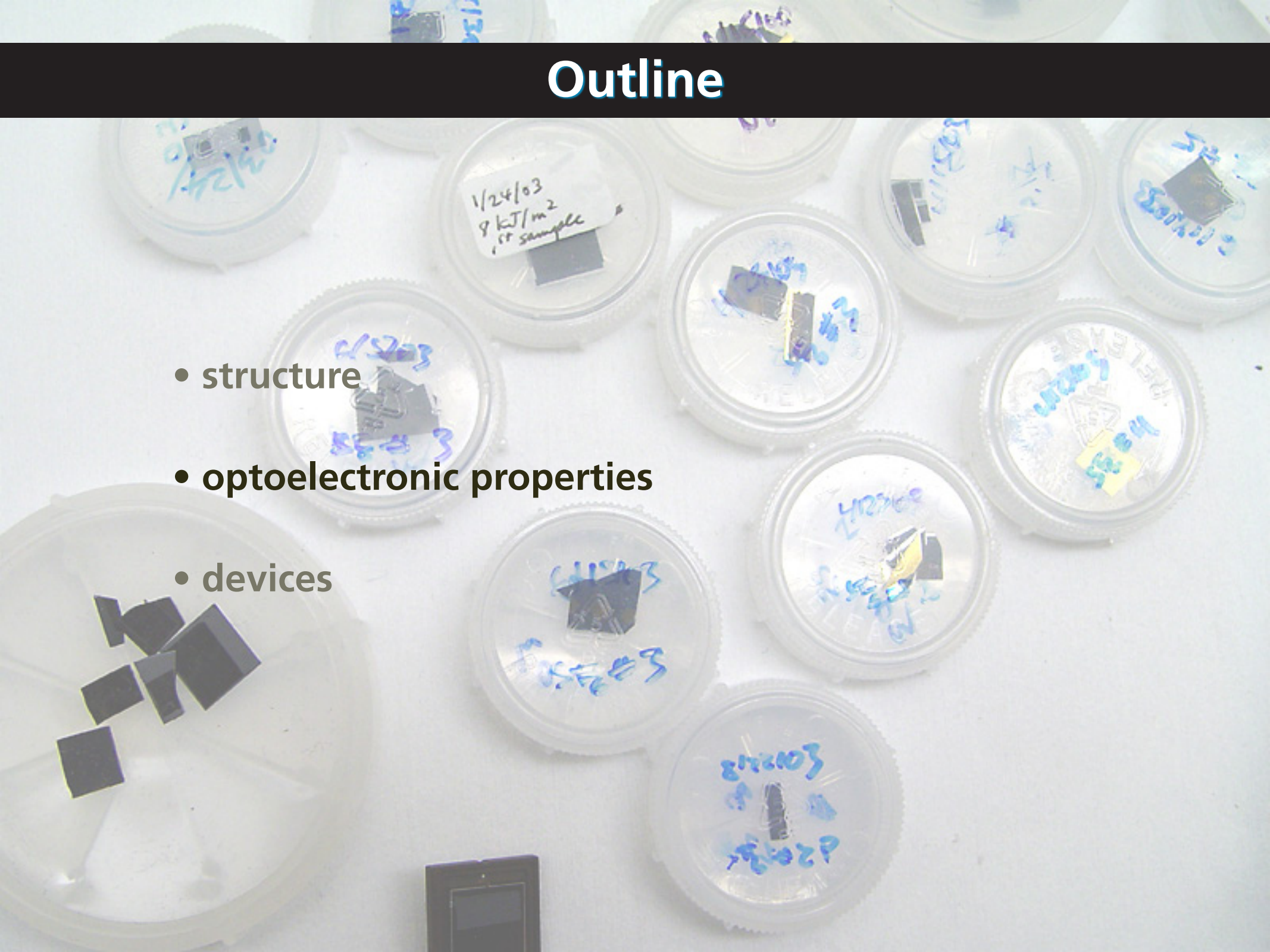

Optoelectronic properties

absorptance ($1 - R_{int} - T_{int}$)

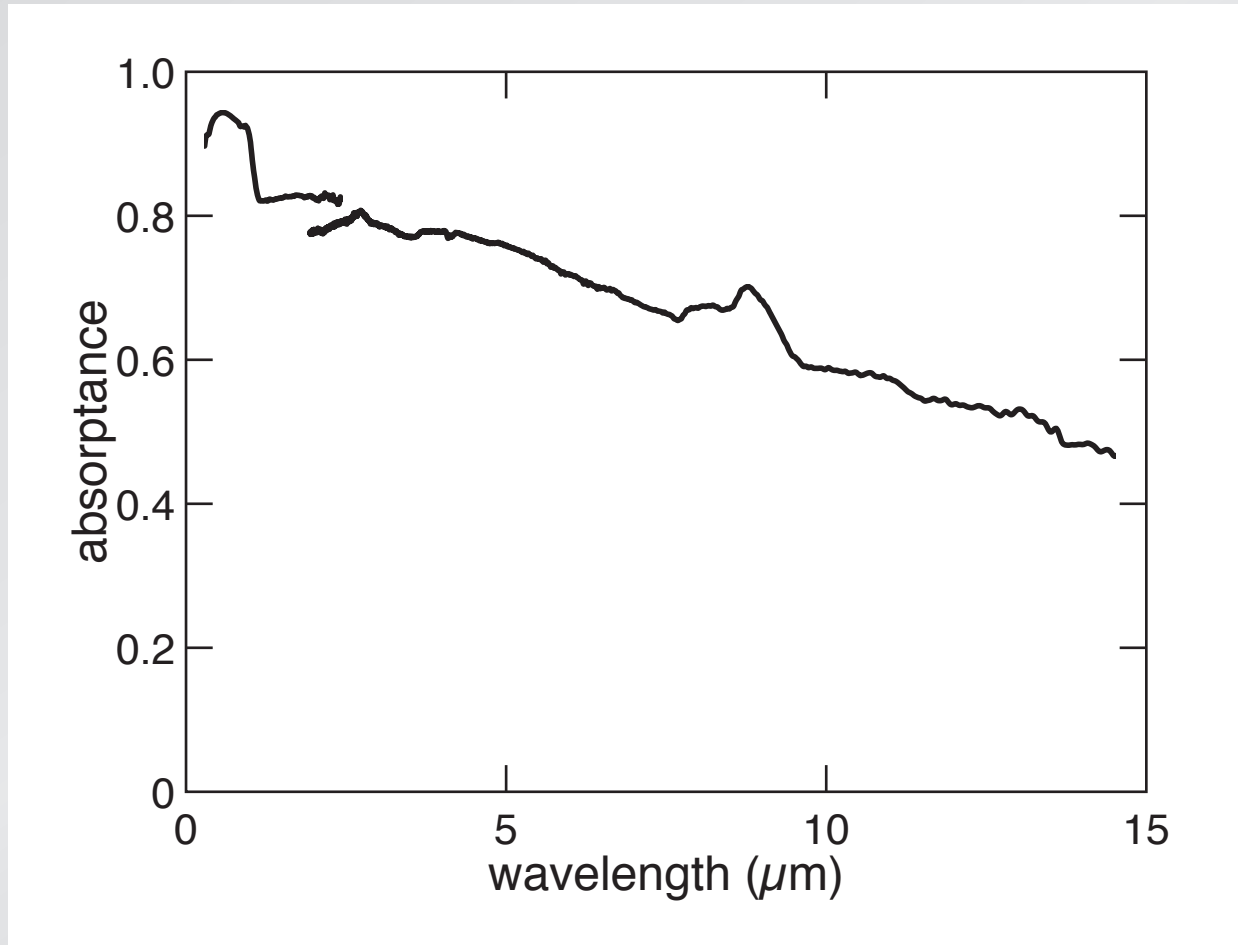

Optoelectronic properties

effect of annealing on IR absorptance

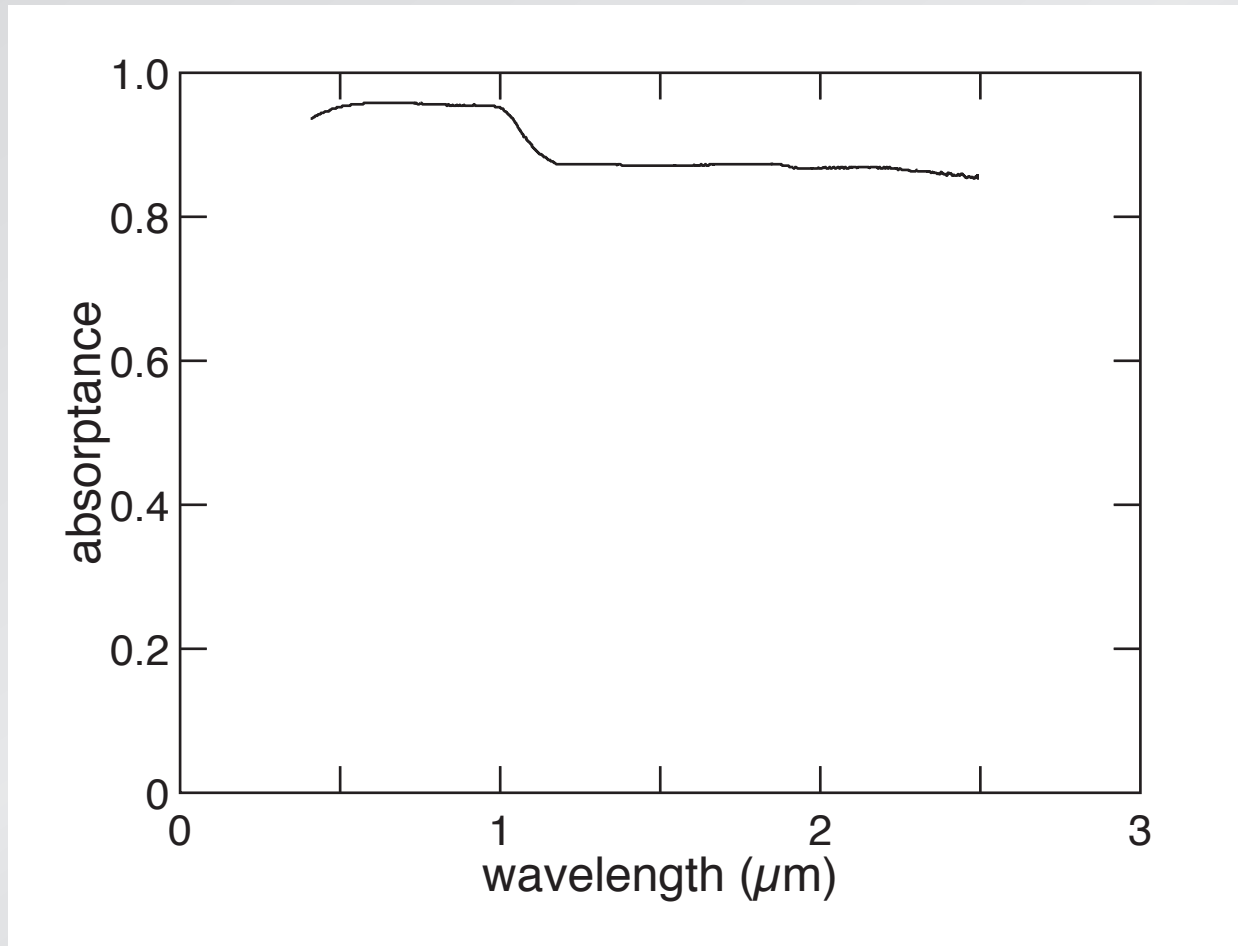

Optoelectronic properties

effect of annealing on IR absorptance

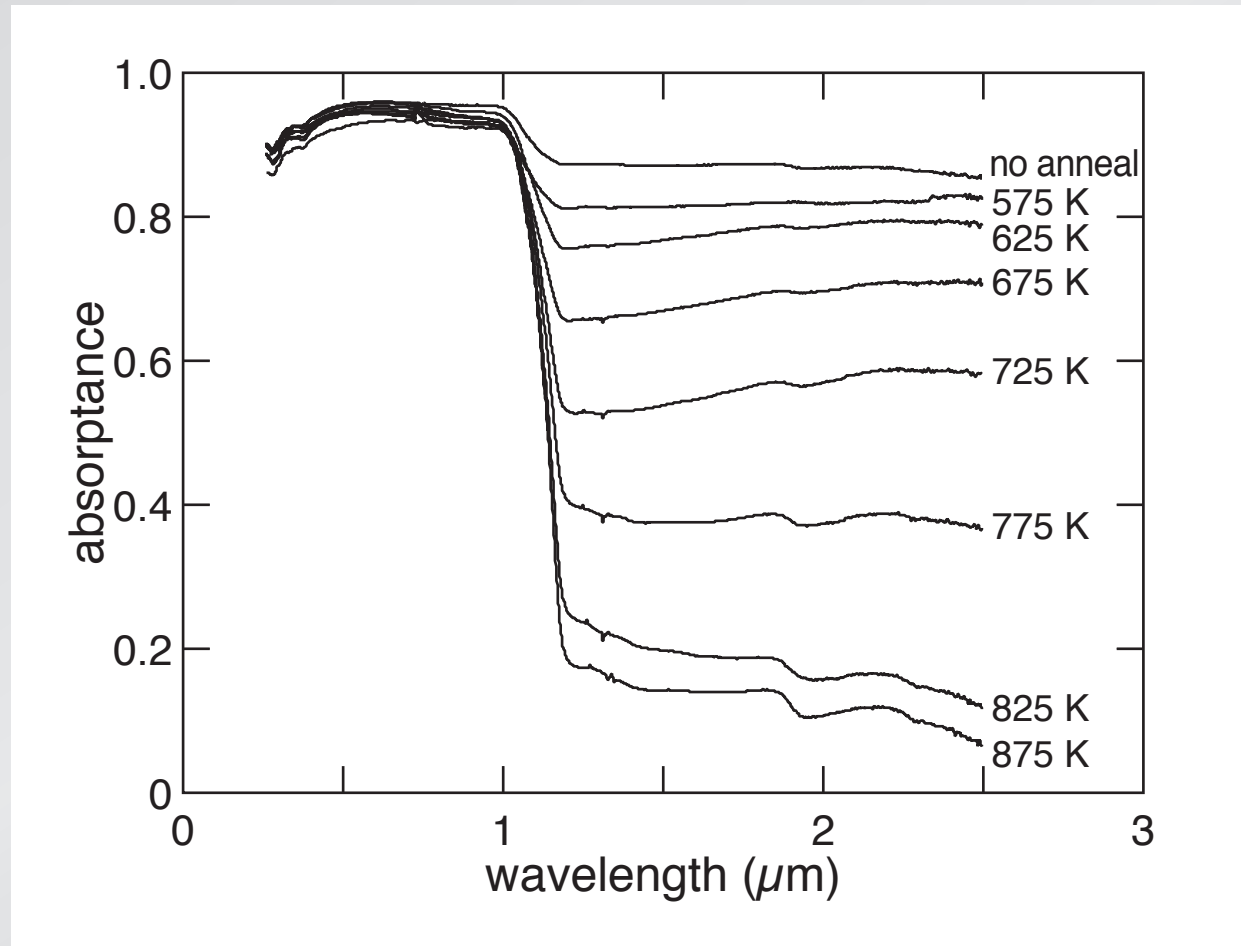

Optoelectronic properties

vary annealing time

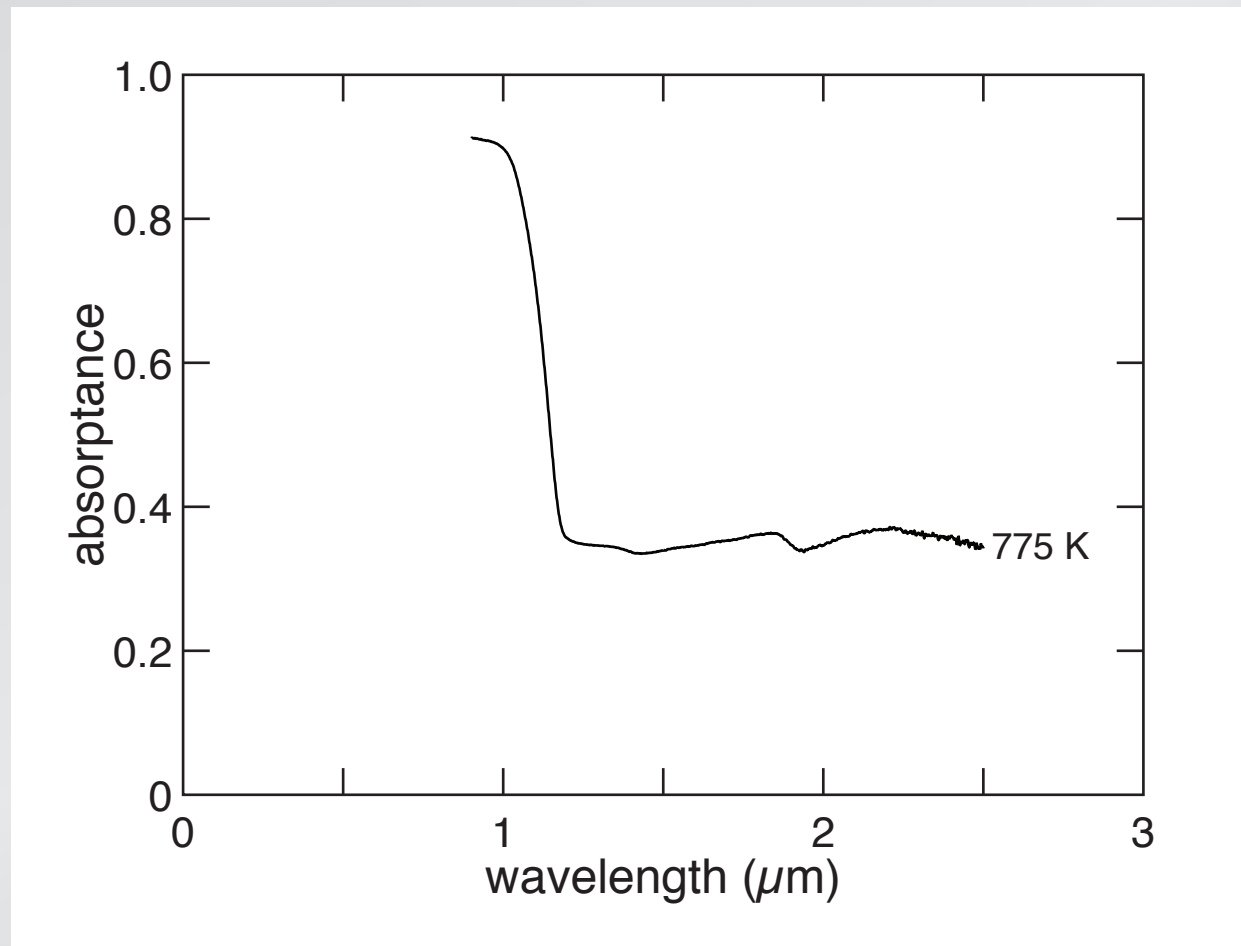

Optoelectronic properties

longer annealing decreases IR absorptance

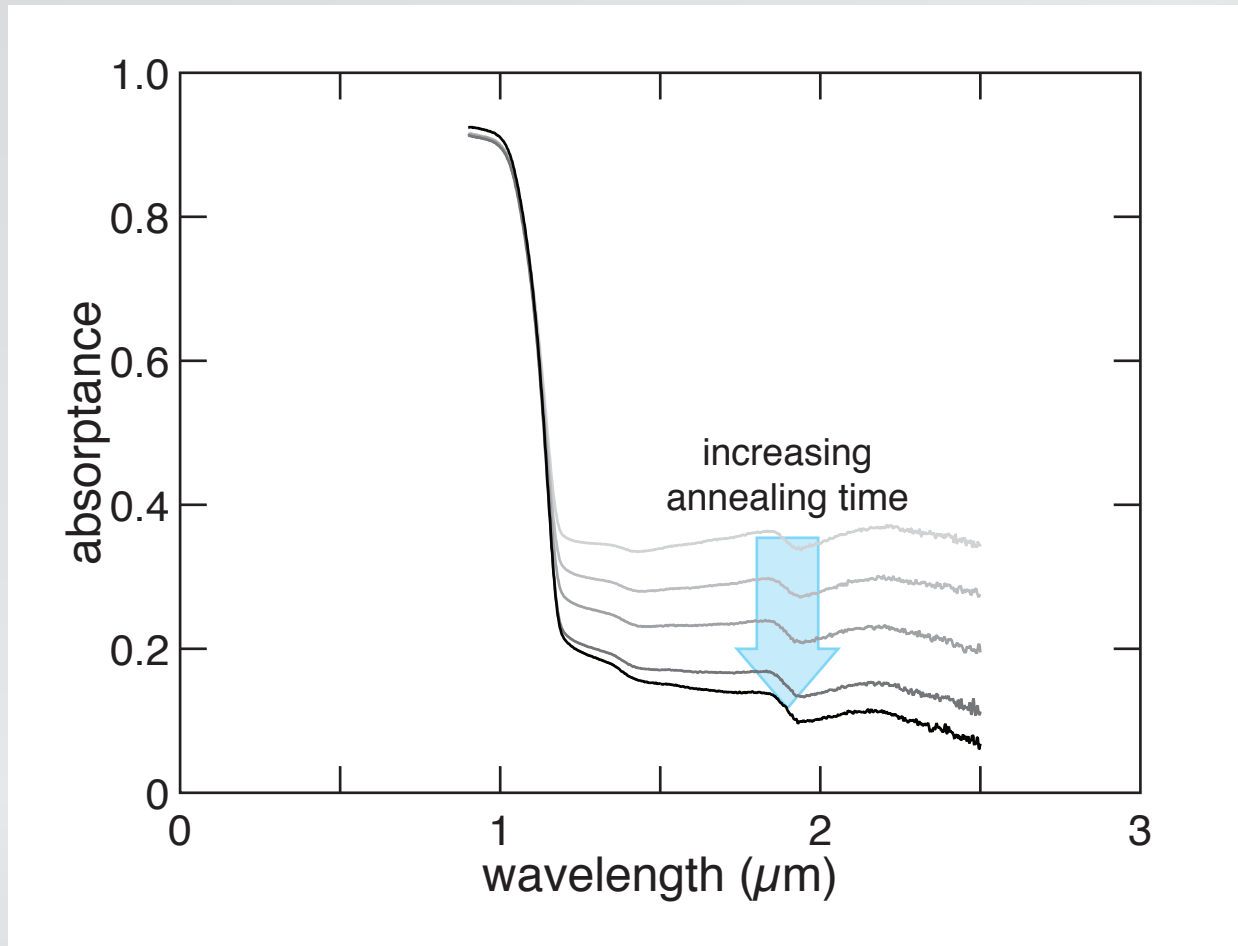

Optoelectronic properties

IR absorptance decreases less for Se-doped samples...

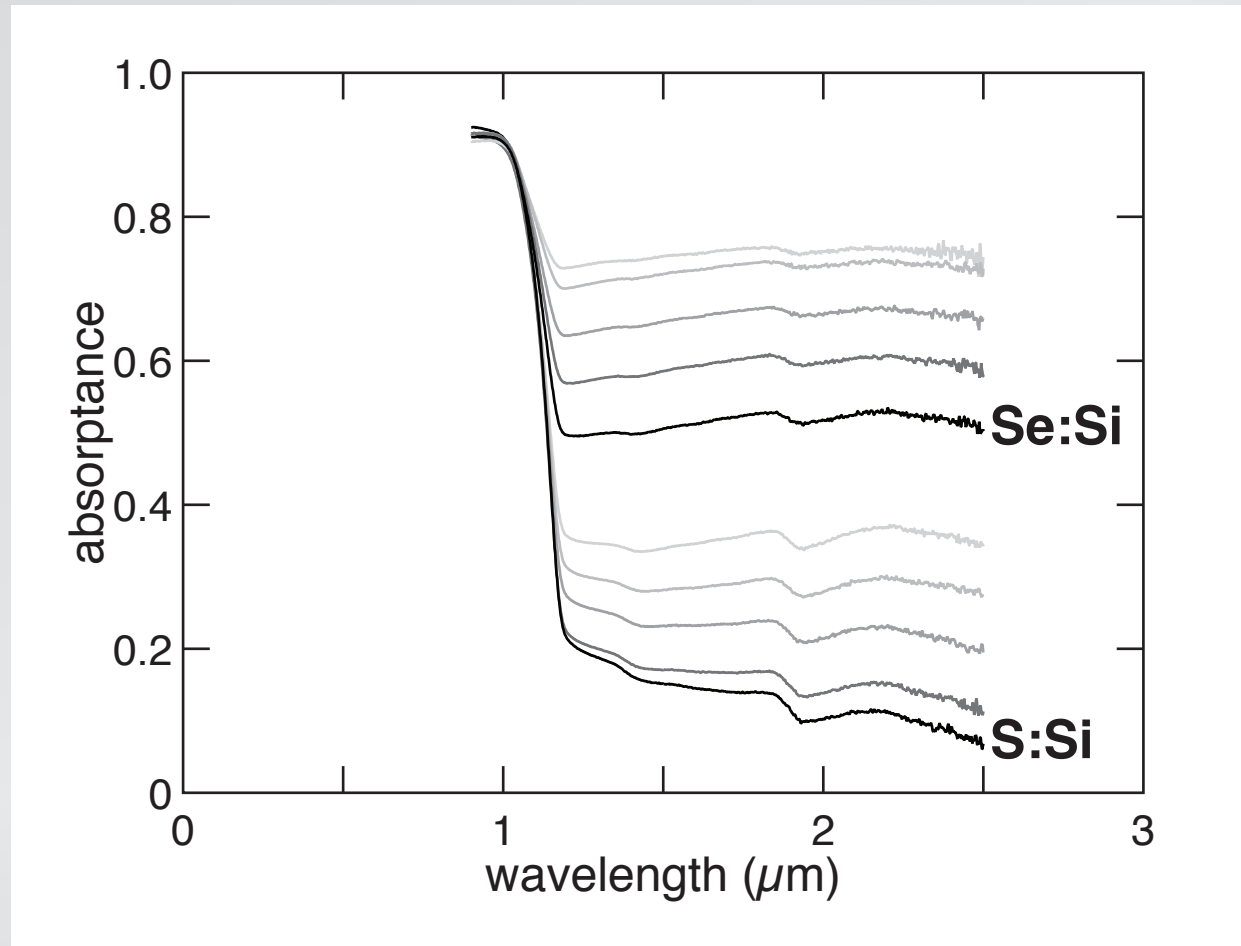

Optoelectronic properties

and even less for Te-doped samples...

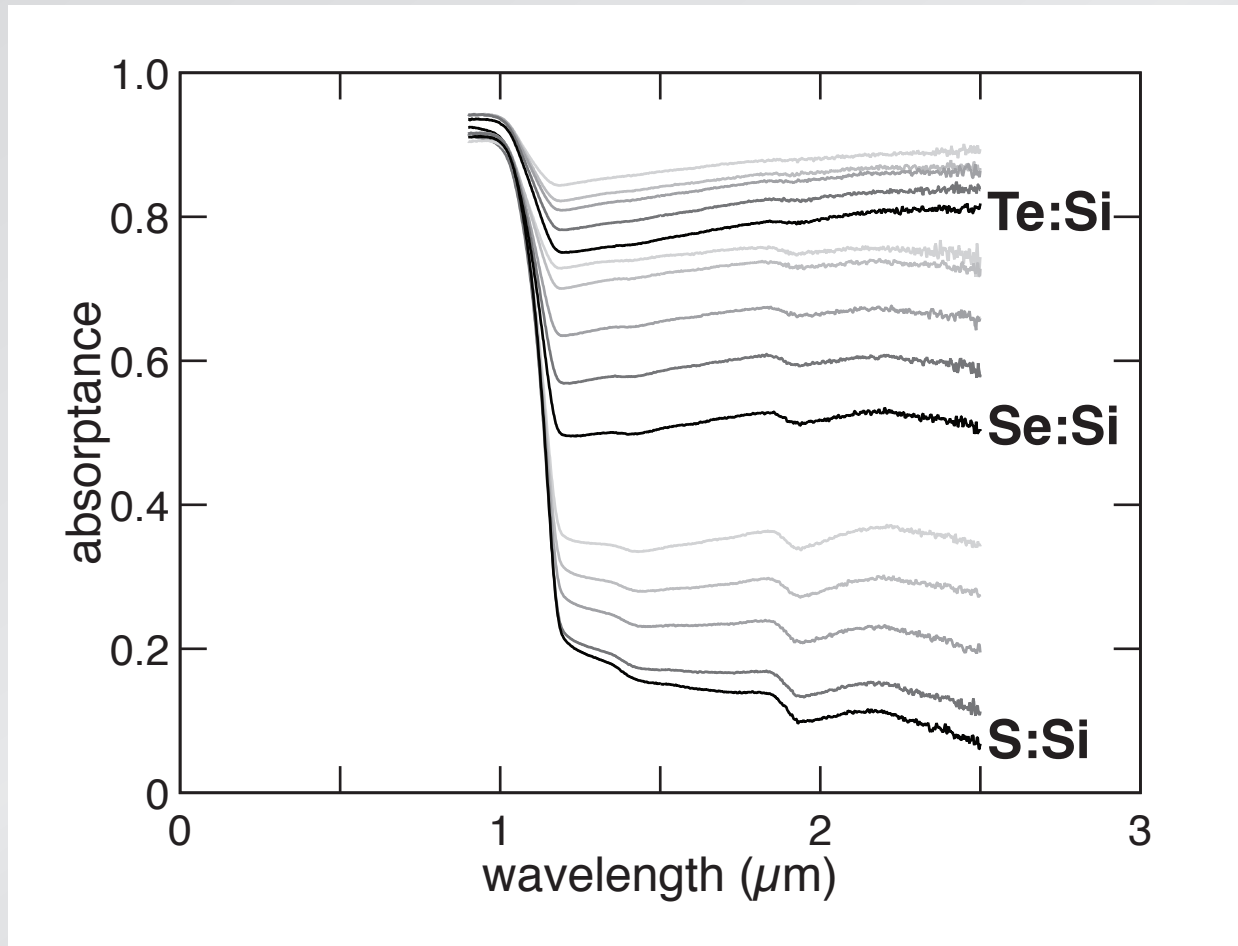

Optoelectronic properties

IR absorptance function of species, T_{anneal} , and t_{anneal} ...

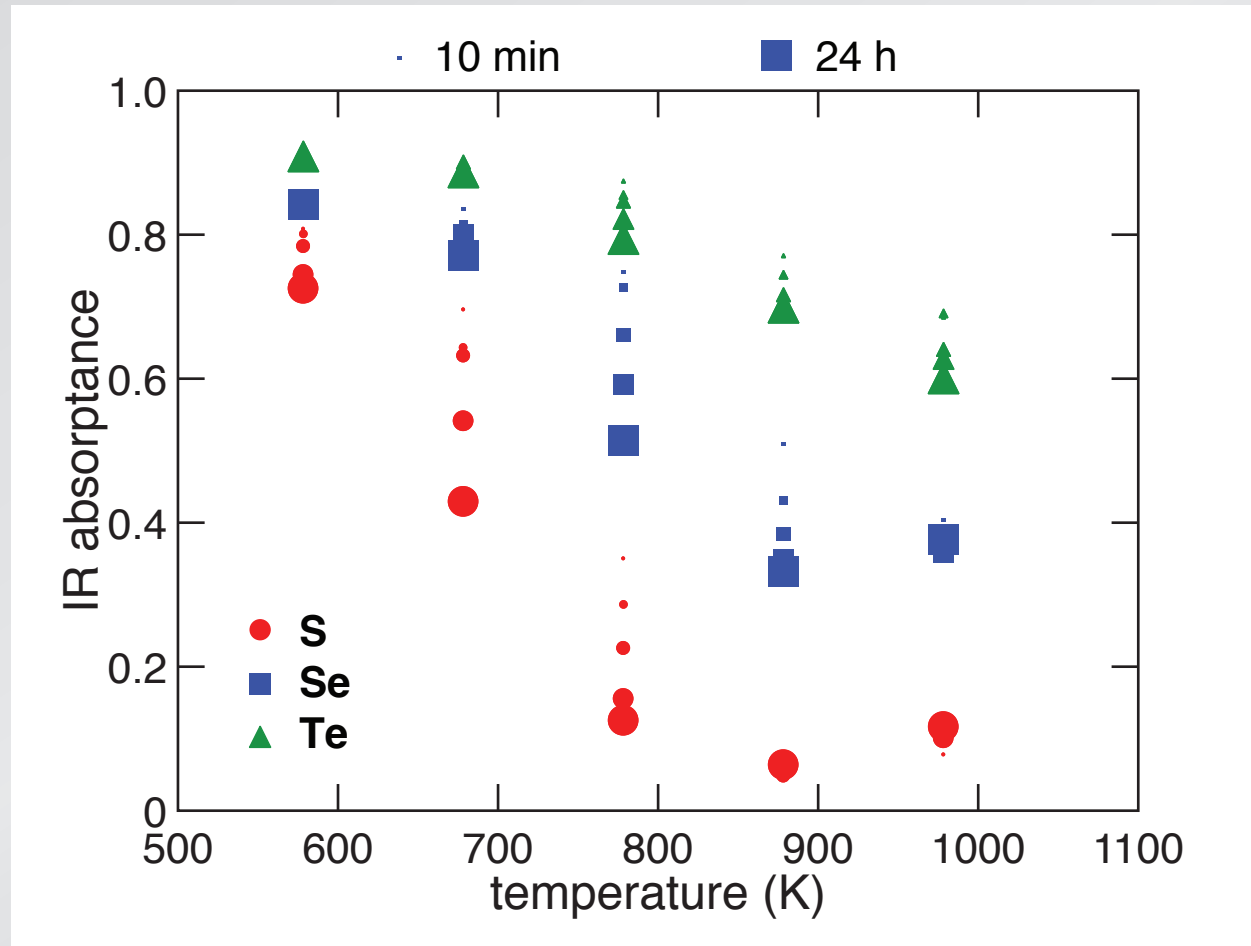

Optoelectronic properties

...but is unique function of diffusion length

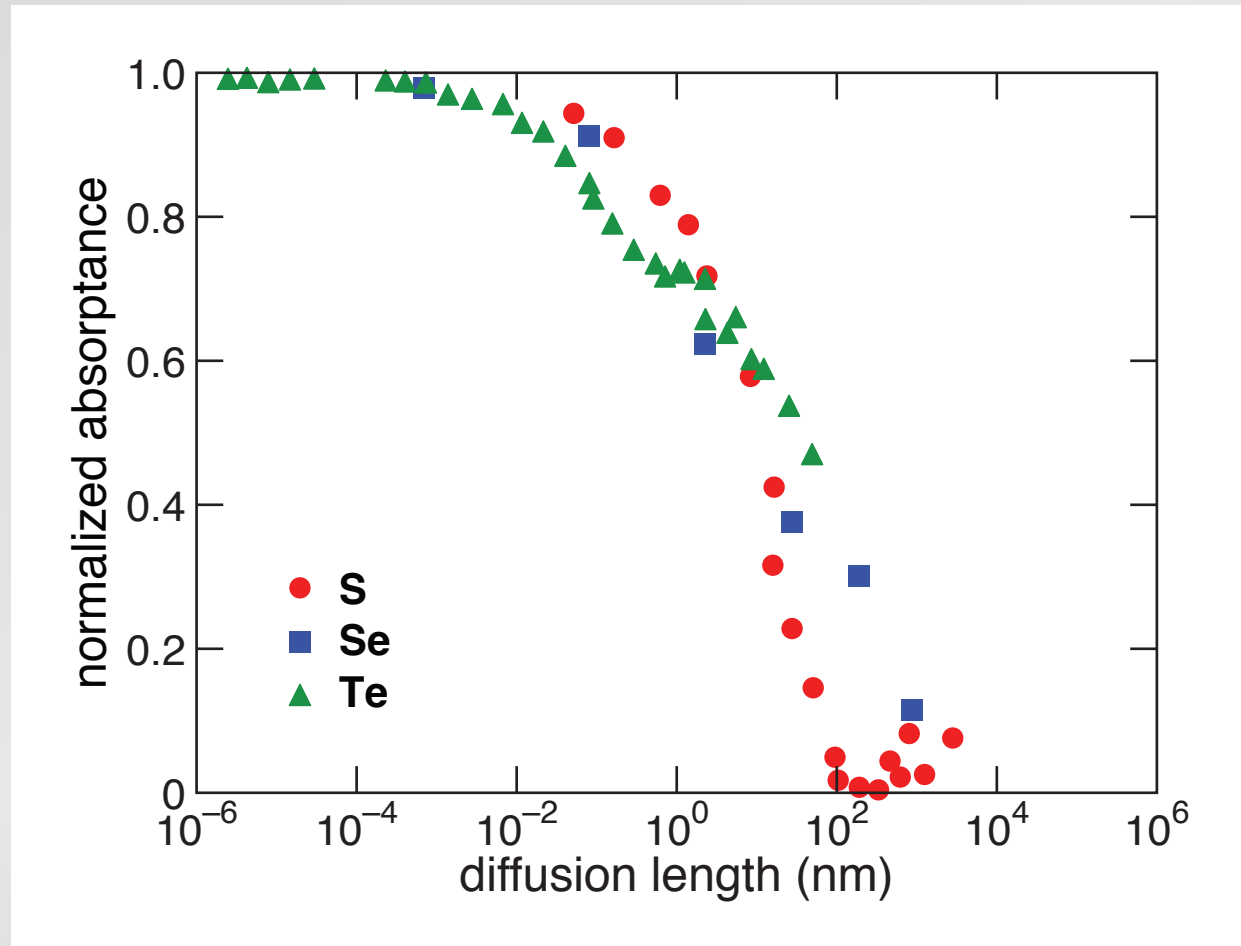

Optoelectronic properties

annealing...

- decreases IR absorptance
- causes recoordination and diffusion of dopants
- IR absorptance reduced by 50% after 20 nm diffusion

Optoelectronic properties

what dopant states/bands cause IR absorption?

Optoelectronic properties

1 part in 10^6 sulfur introduces donor states in gap

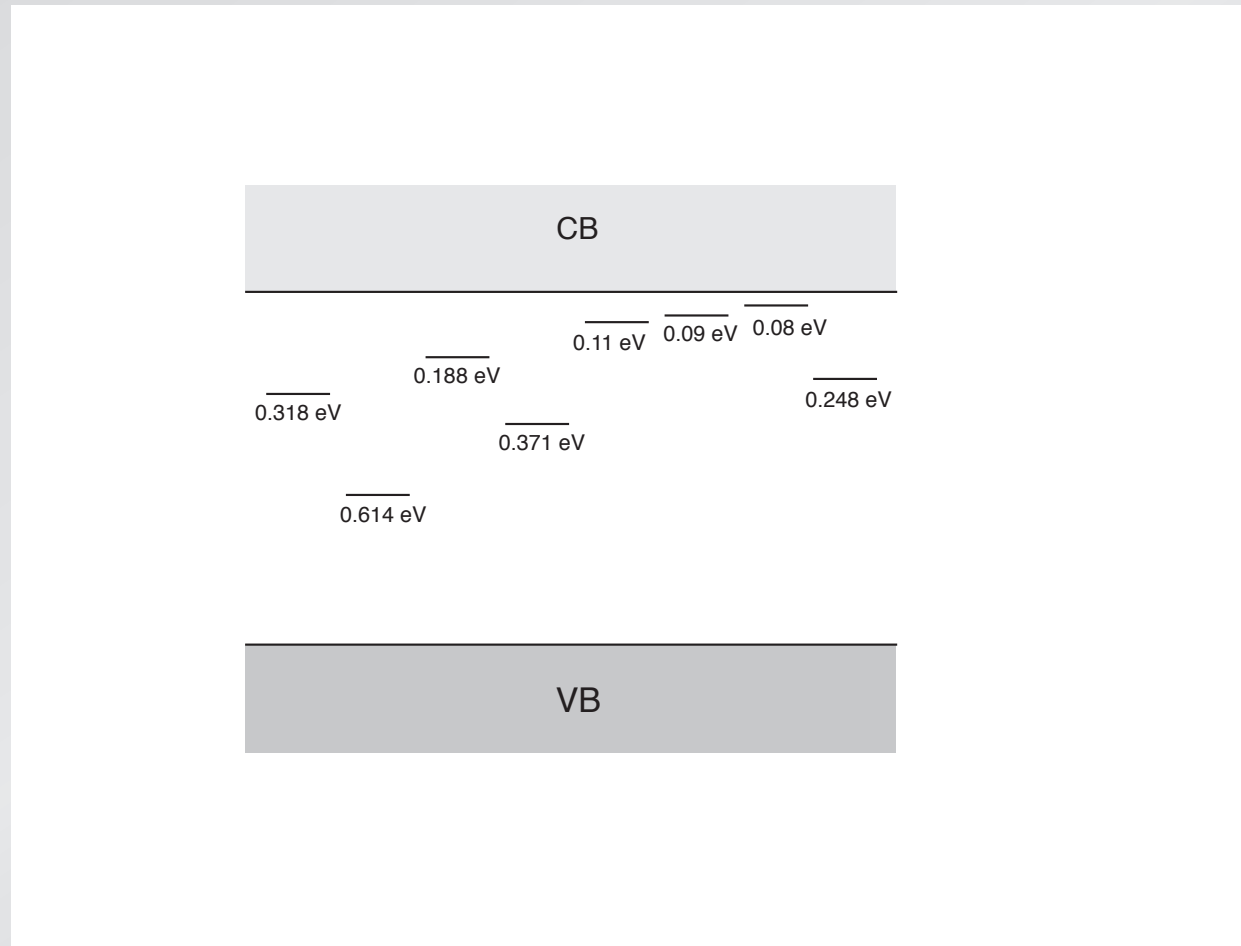

Optoelectronic properties

1 part in 10^6 sulfur introduces donor states in gap

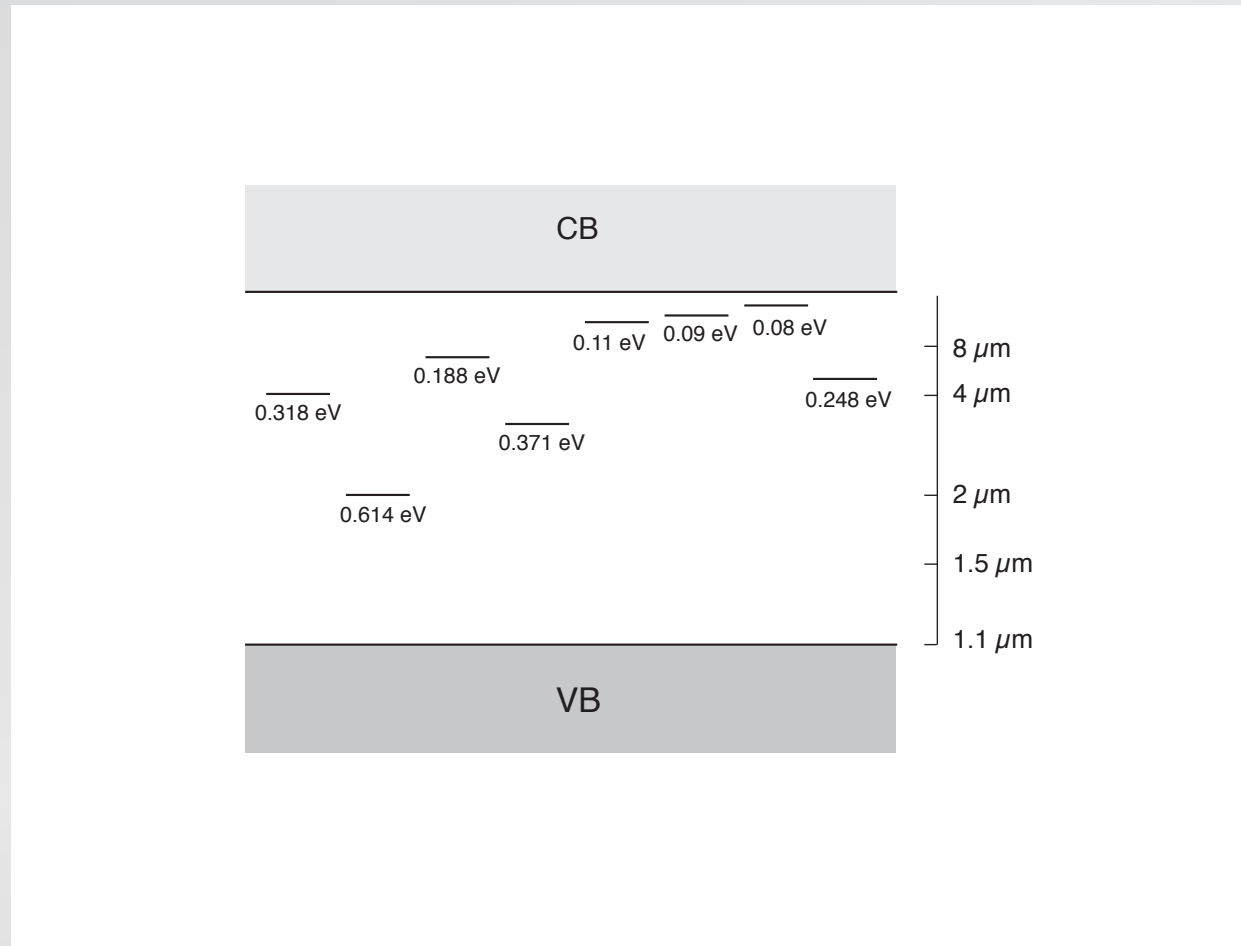

Optoelectronic properties

1 part in 10^6 sulfur introduces donor states in gap

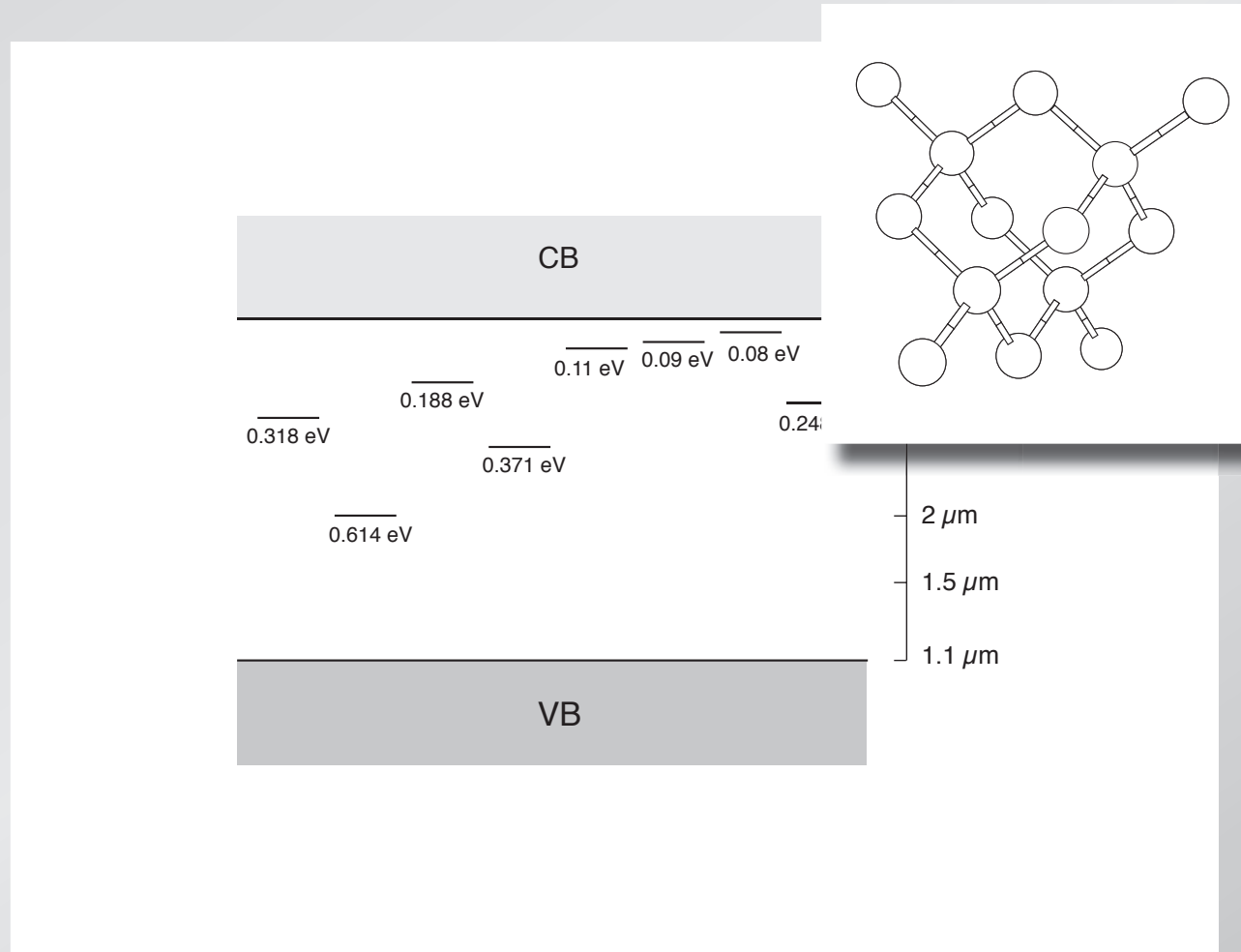

Optoelectronic properties

1 part in 10^6 sulfur introduces donor states in gap

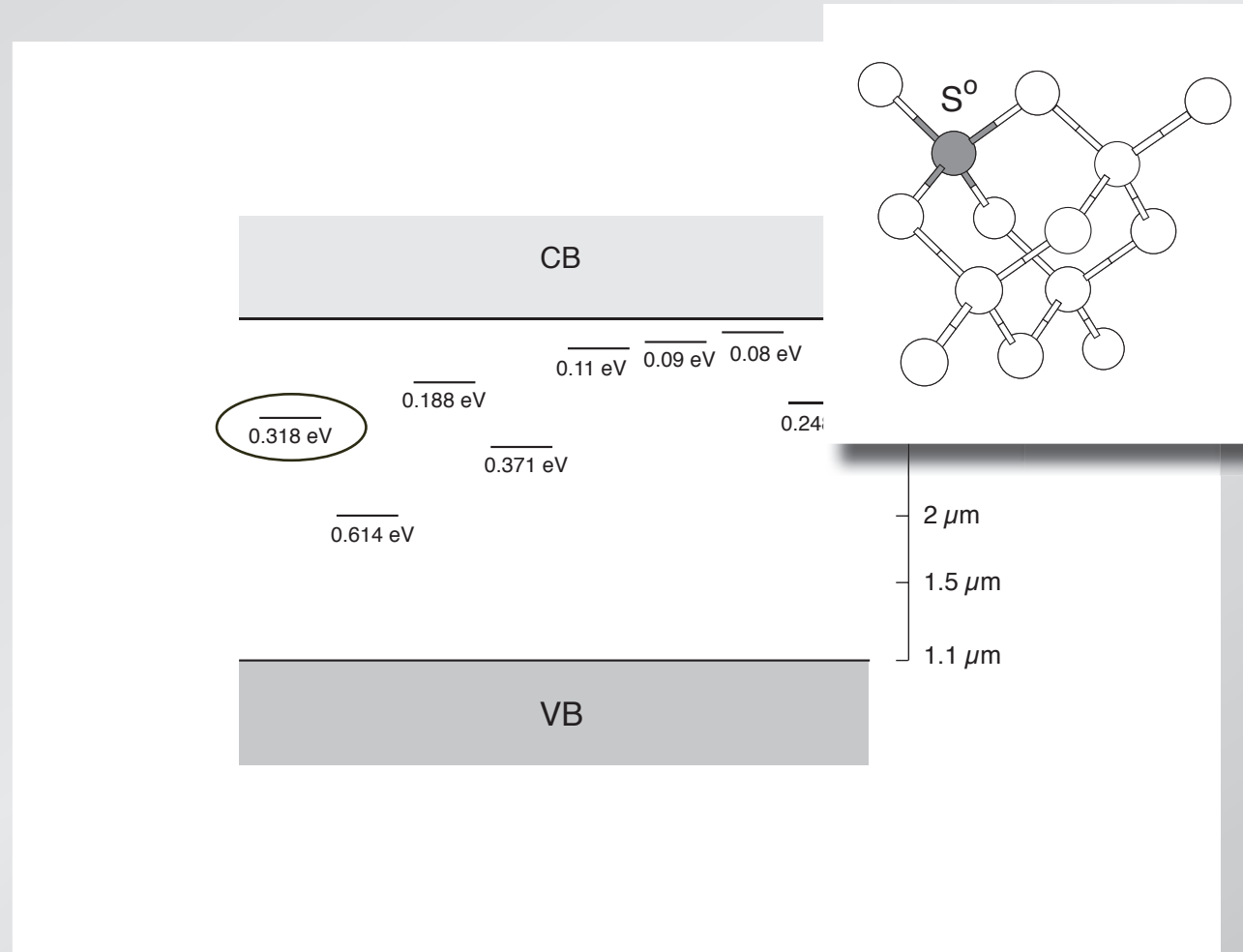

Optoelectronic properties

1 part in 10^6 sulfur introduces donor states in gap

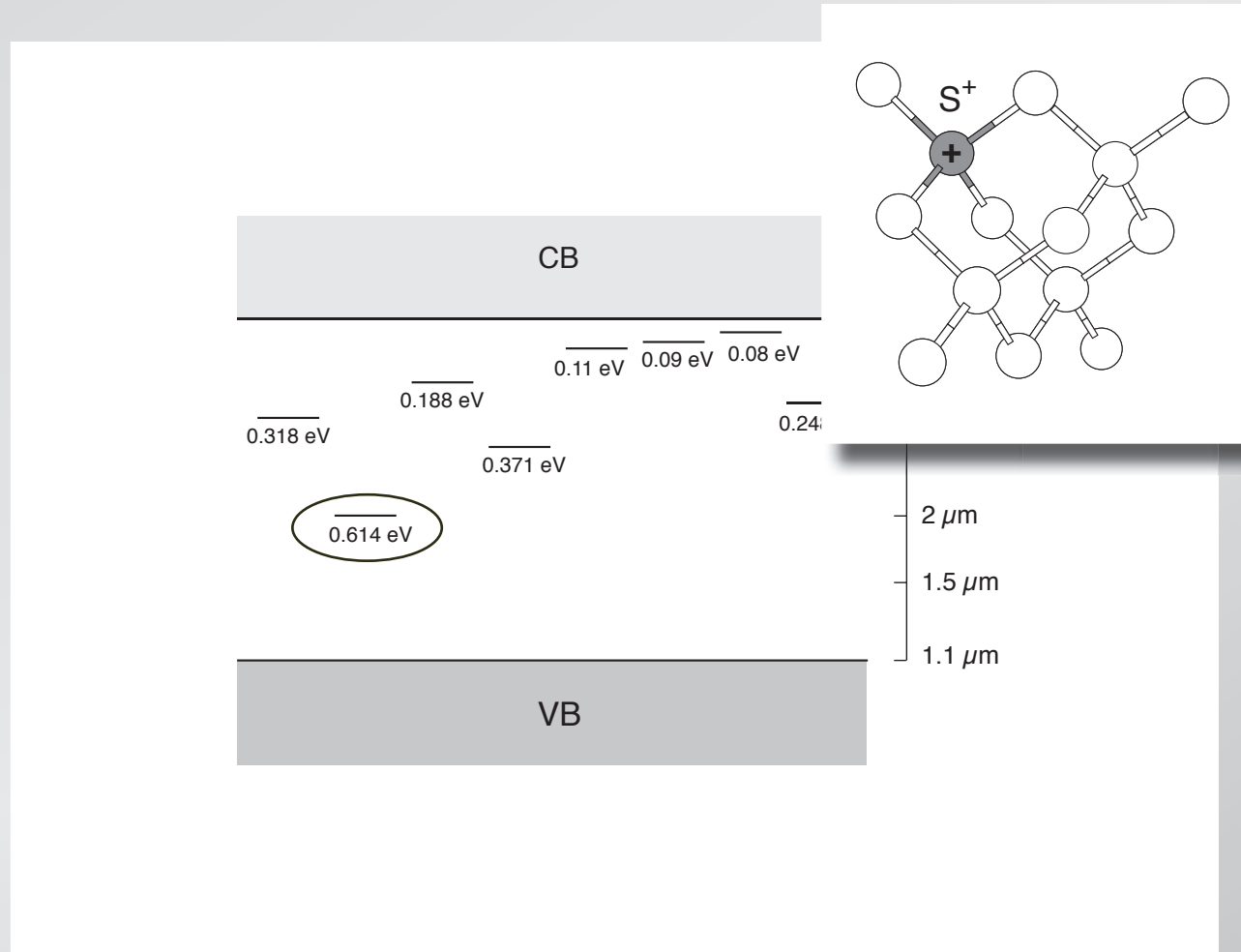

Optoelectronic properties

1 part in 10^6 sulfur introduces donor states in gap

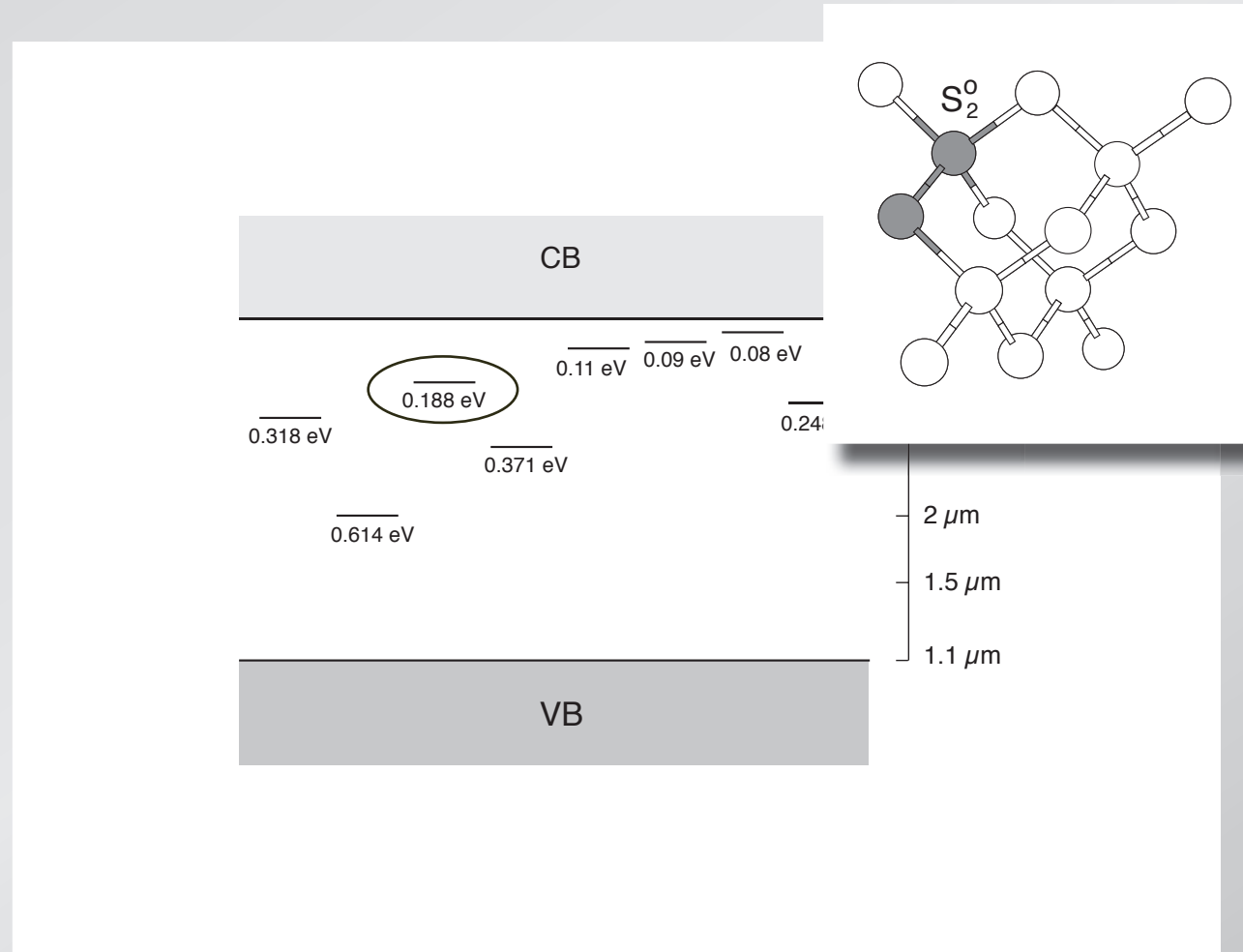

Optoelectronic properties

1 part in 10^6 sulfur introduces donor states in gap

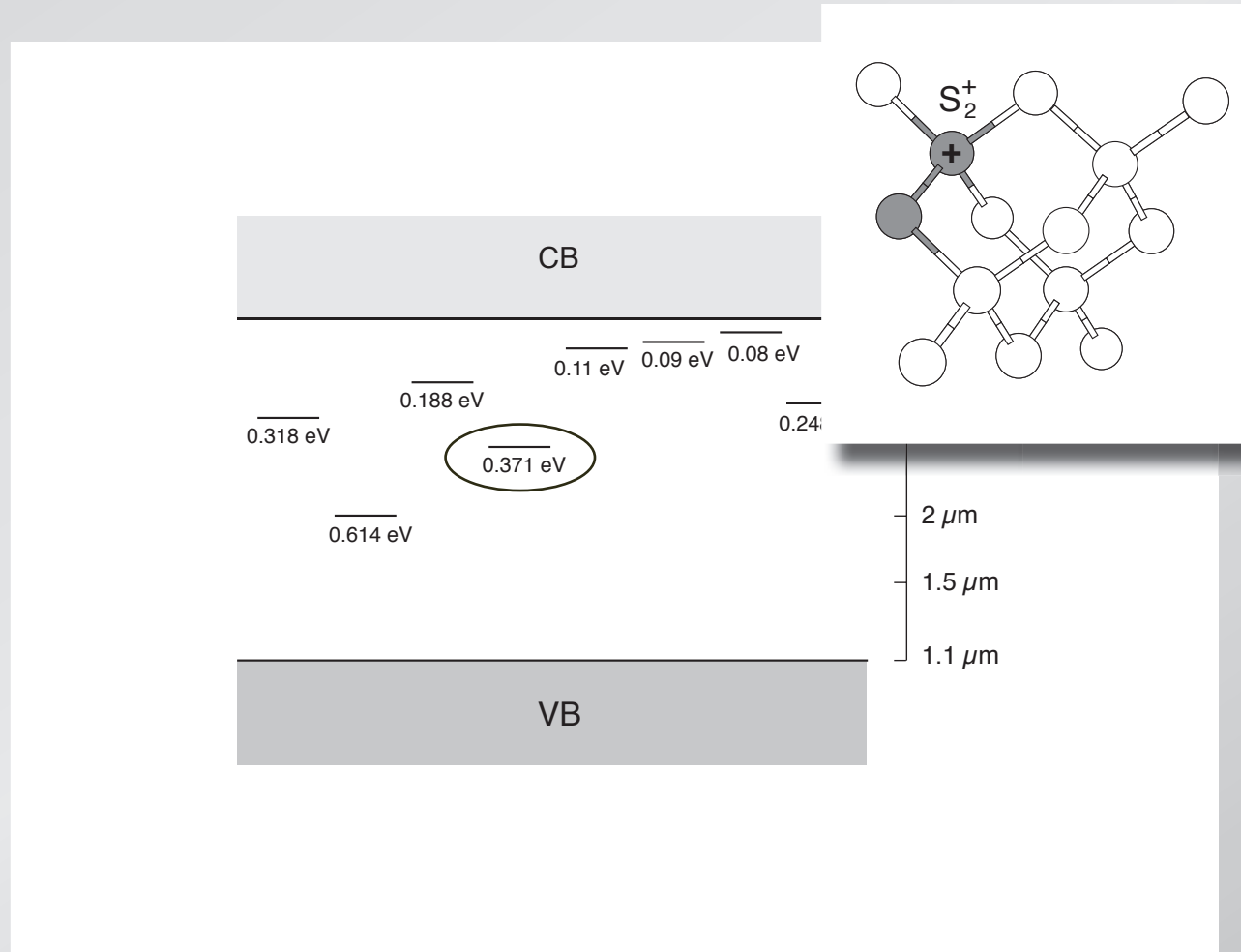

Optoelectronic properties

1 part in 10^6 sulfur introduces donor states in gap

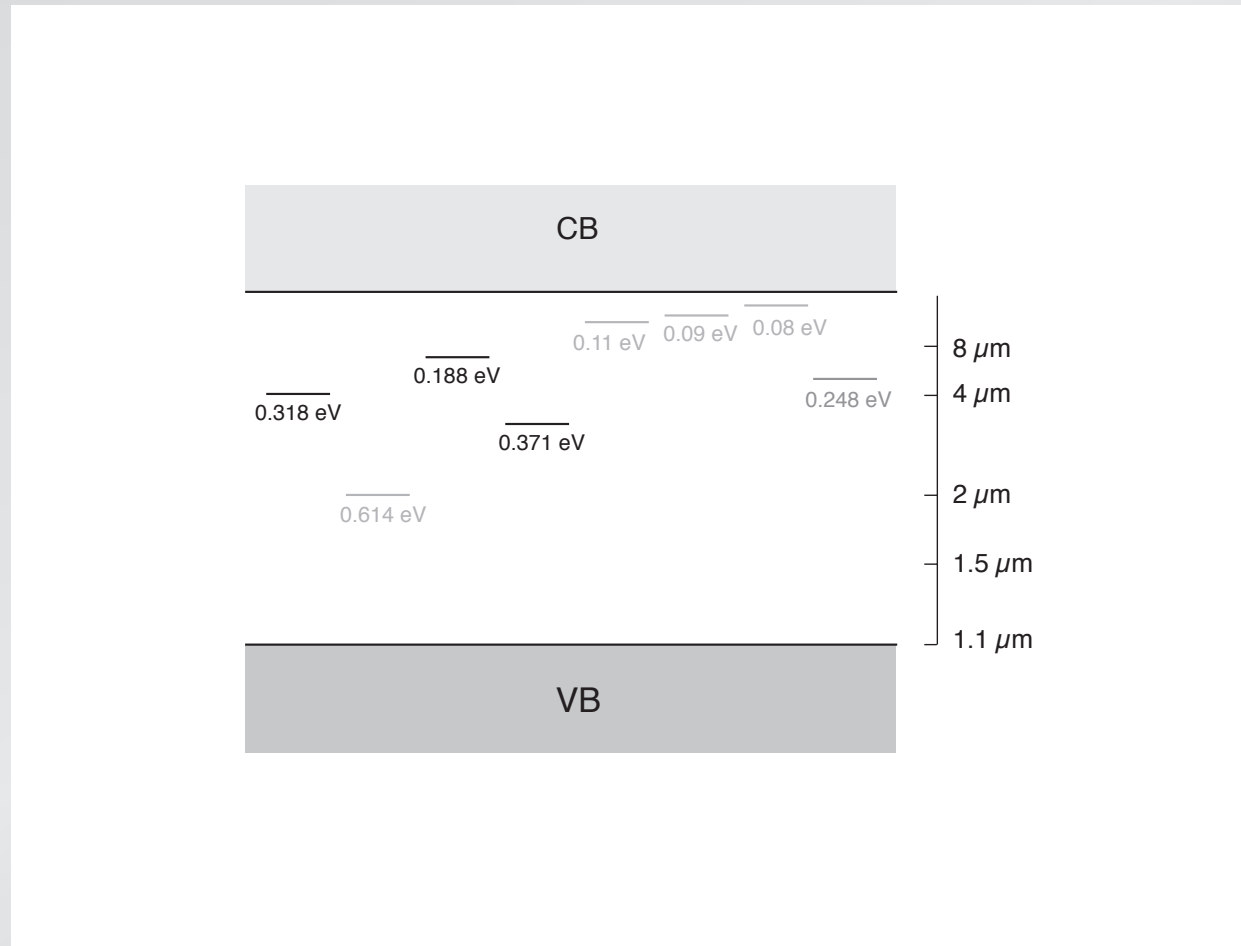

Optoelectronic properties

at high concentration states broaden into band

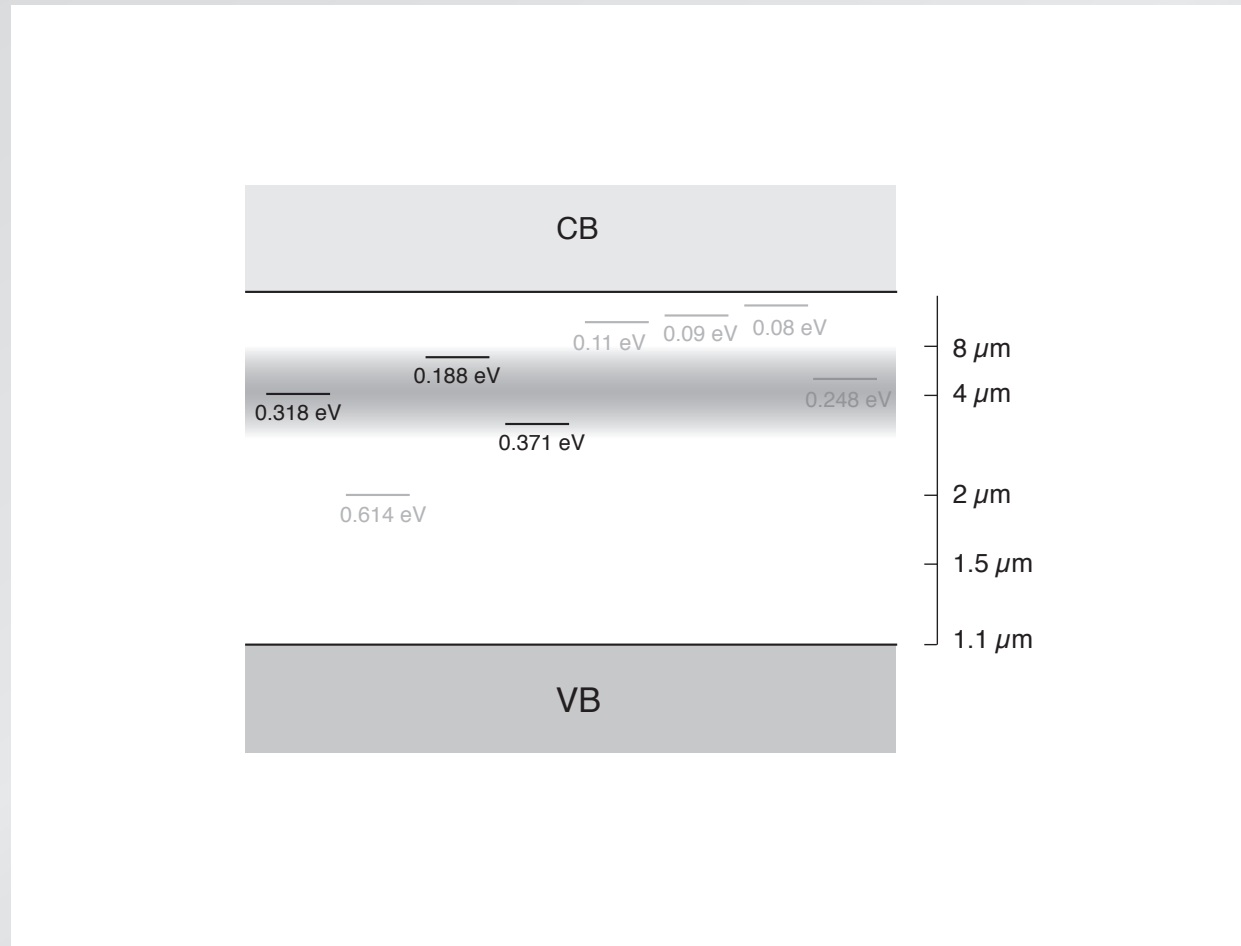

Optoelectronic properties

absorptance ($1 - R_{int} - T_{int}$)

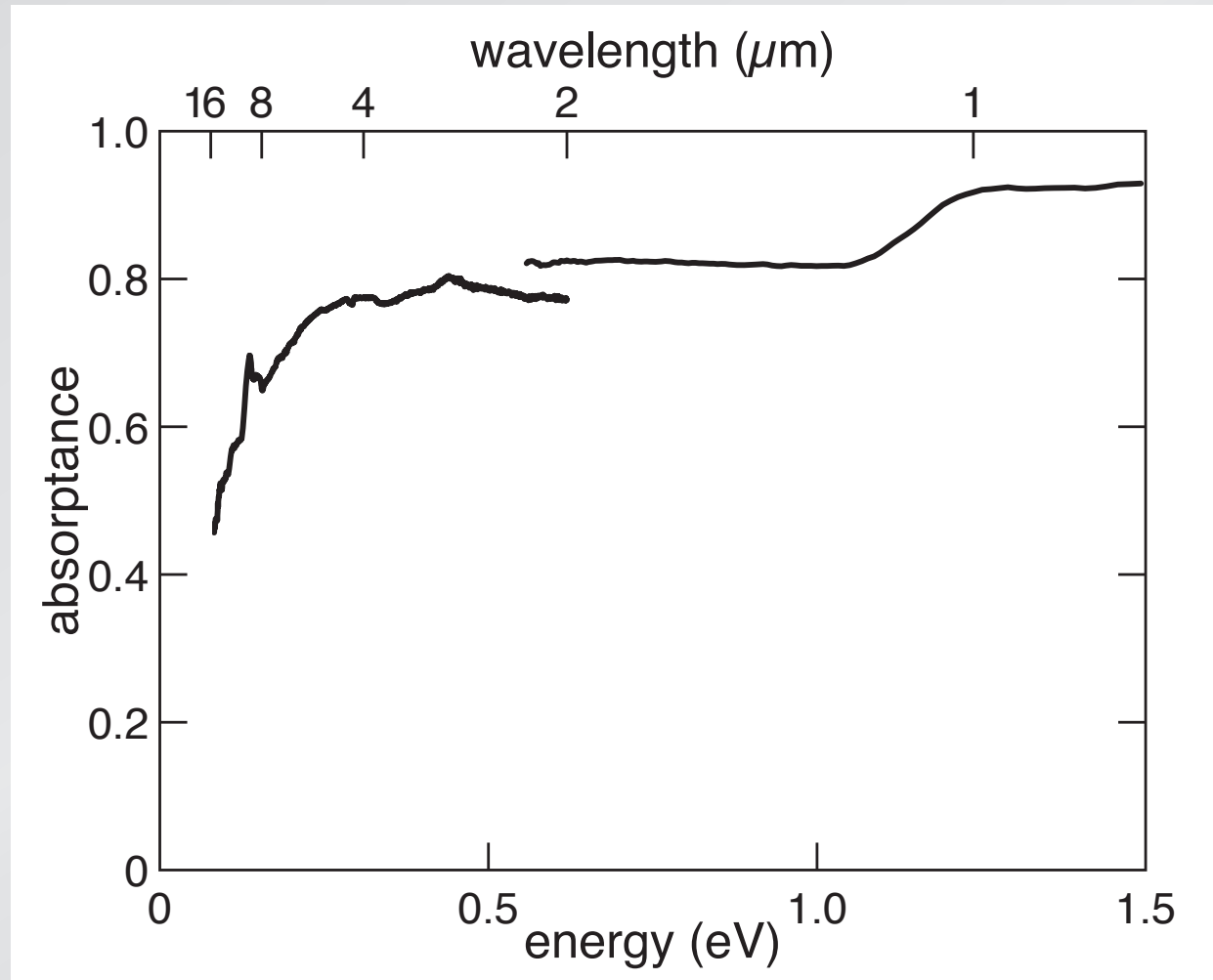

Optoelectronic properties

absorptance ($1 - R_{int} - T_{int}$)

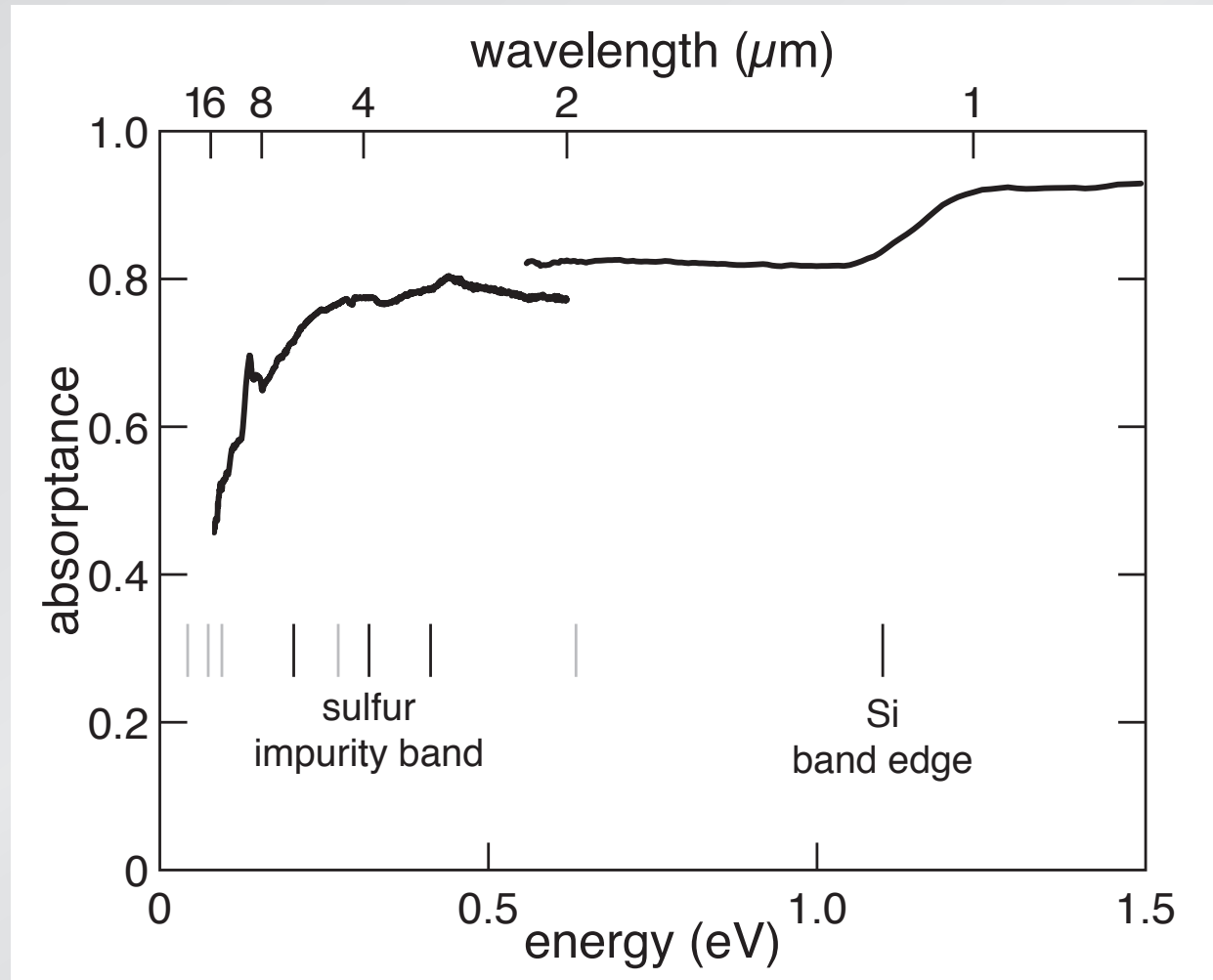

Optoelectronic properties

should have shallow junction below surface

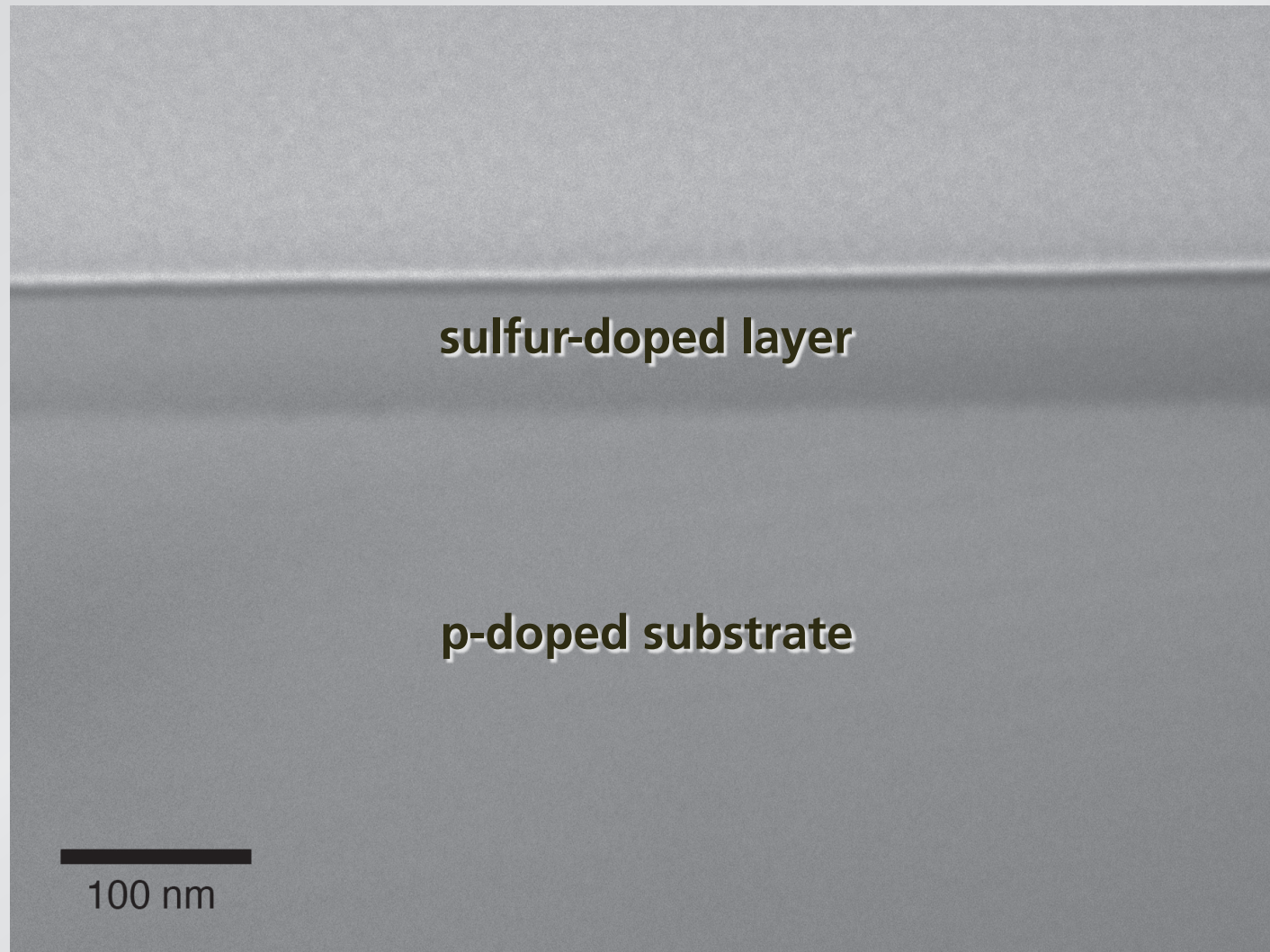

Optoelectronic properties

excellent rectification (after annealing)

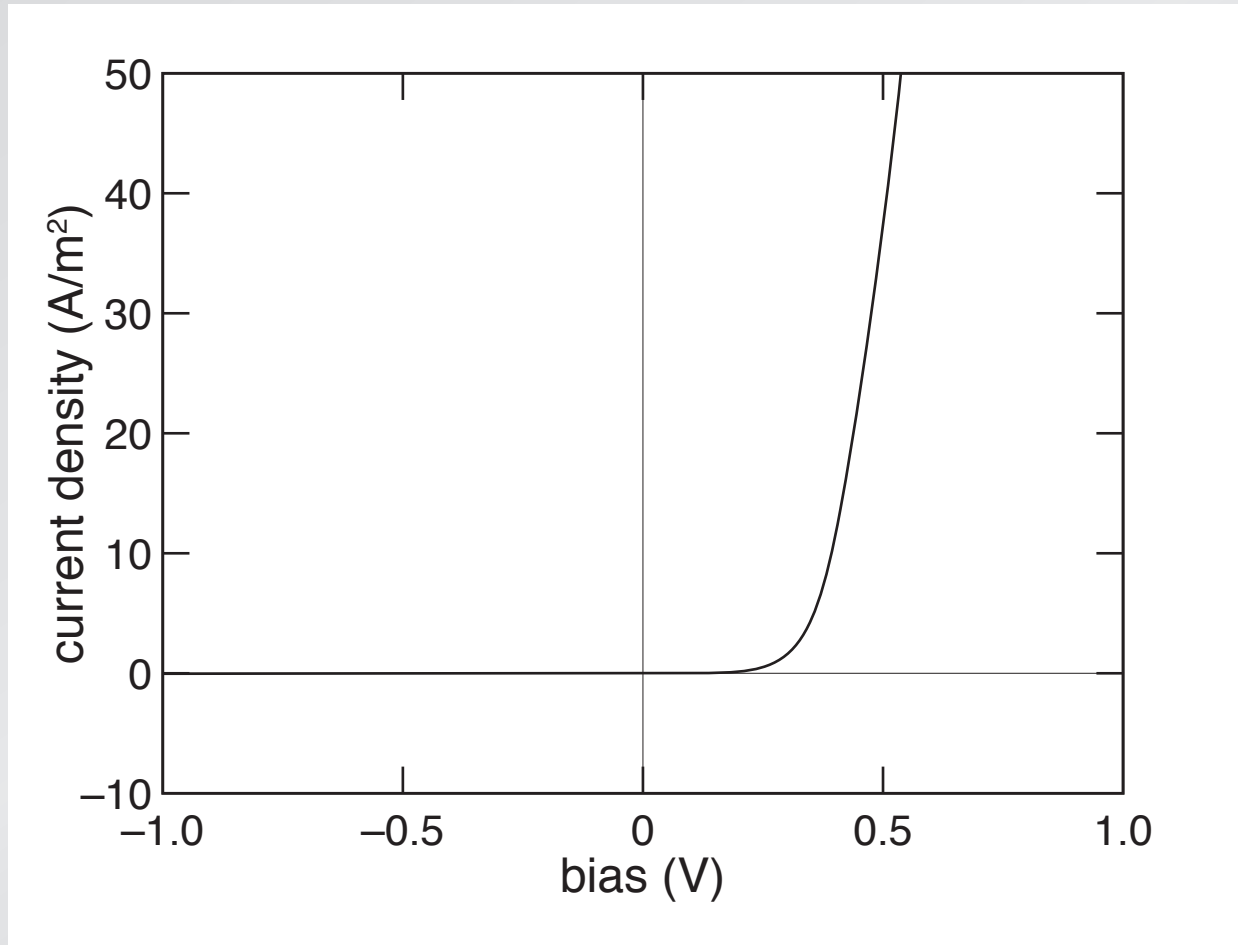

Optoelectronic properties

probe impurity states by varying Fermi level in substrate

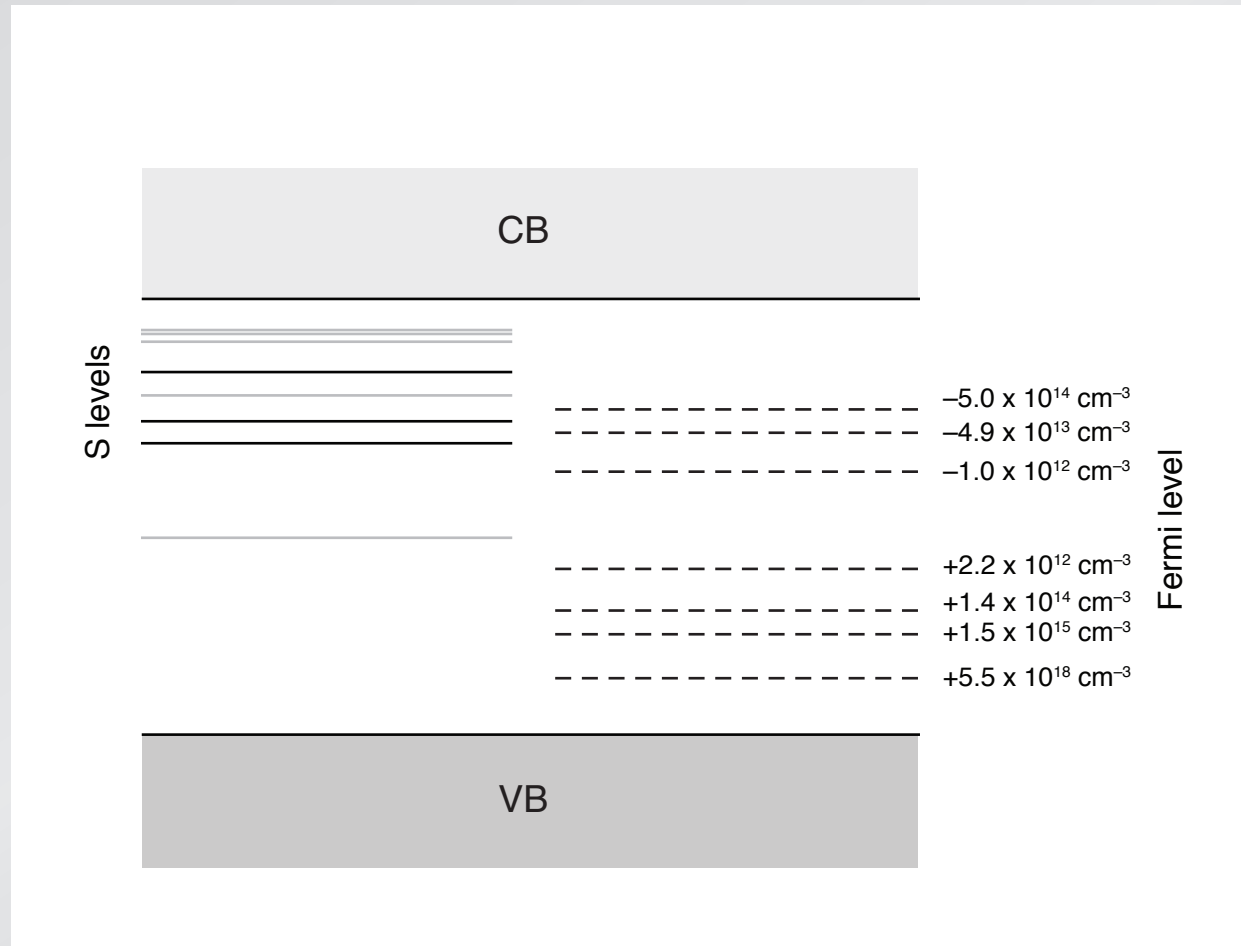

Optoelectronic properties

probe impurity states by varying Fermi level in substrate

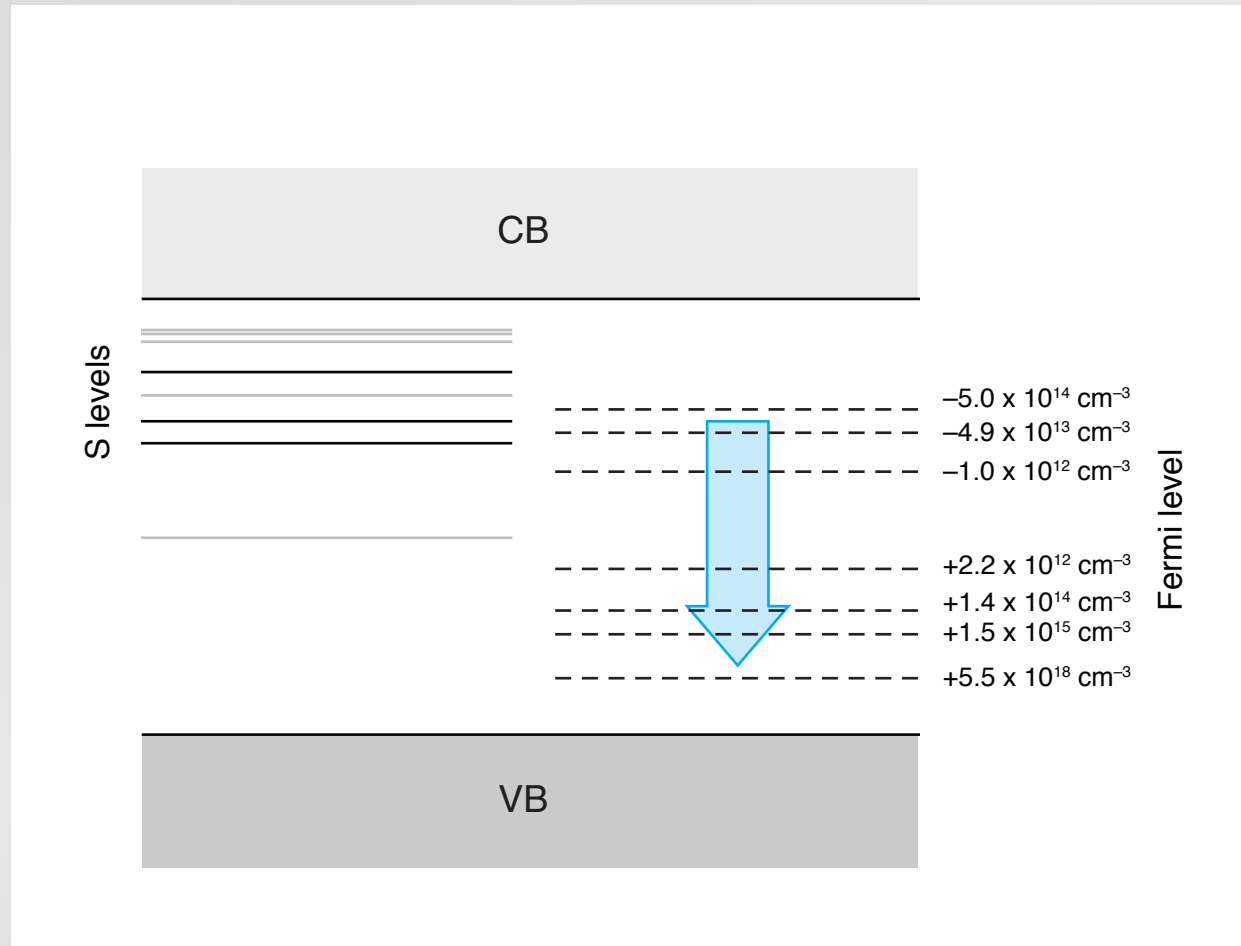

Optoelectronic properties

vary substrate doping type and resistivity

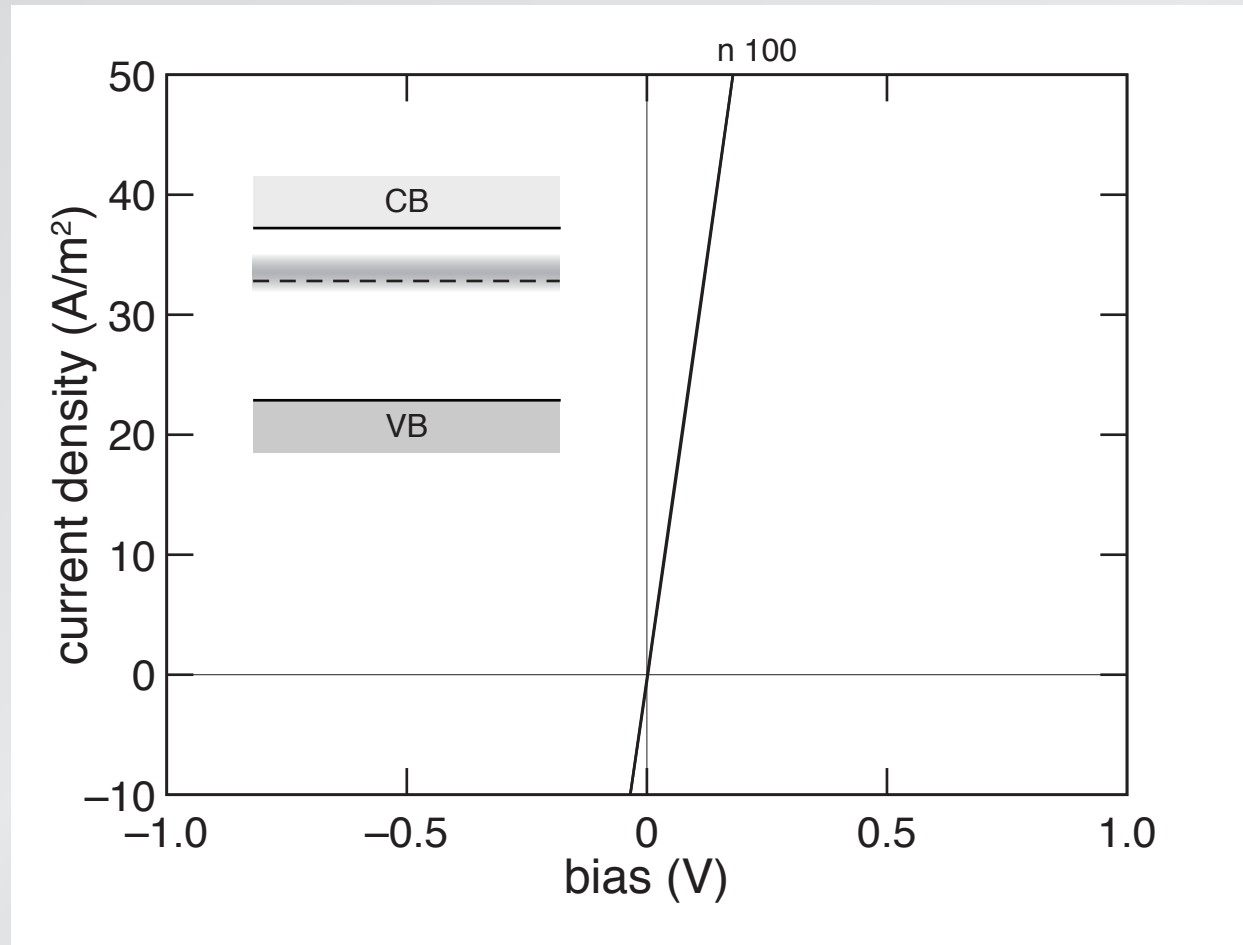

Optoelectronic properties

vary substrate doping type and resistivity

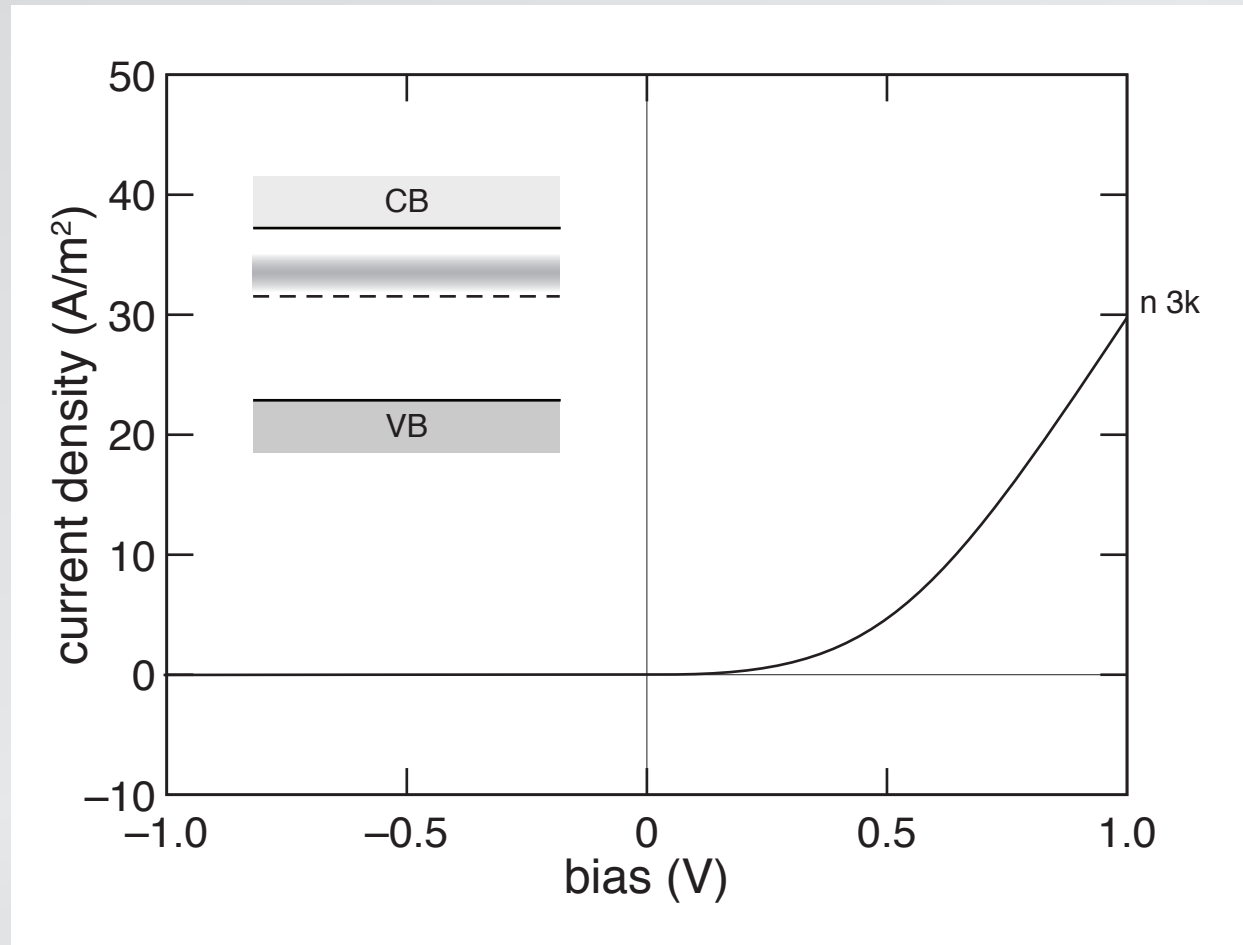

Optoelectronic properties

vary substrate doping type and resistivity

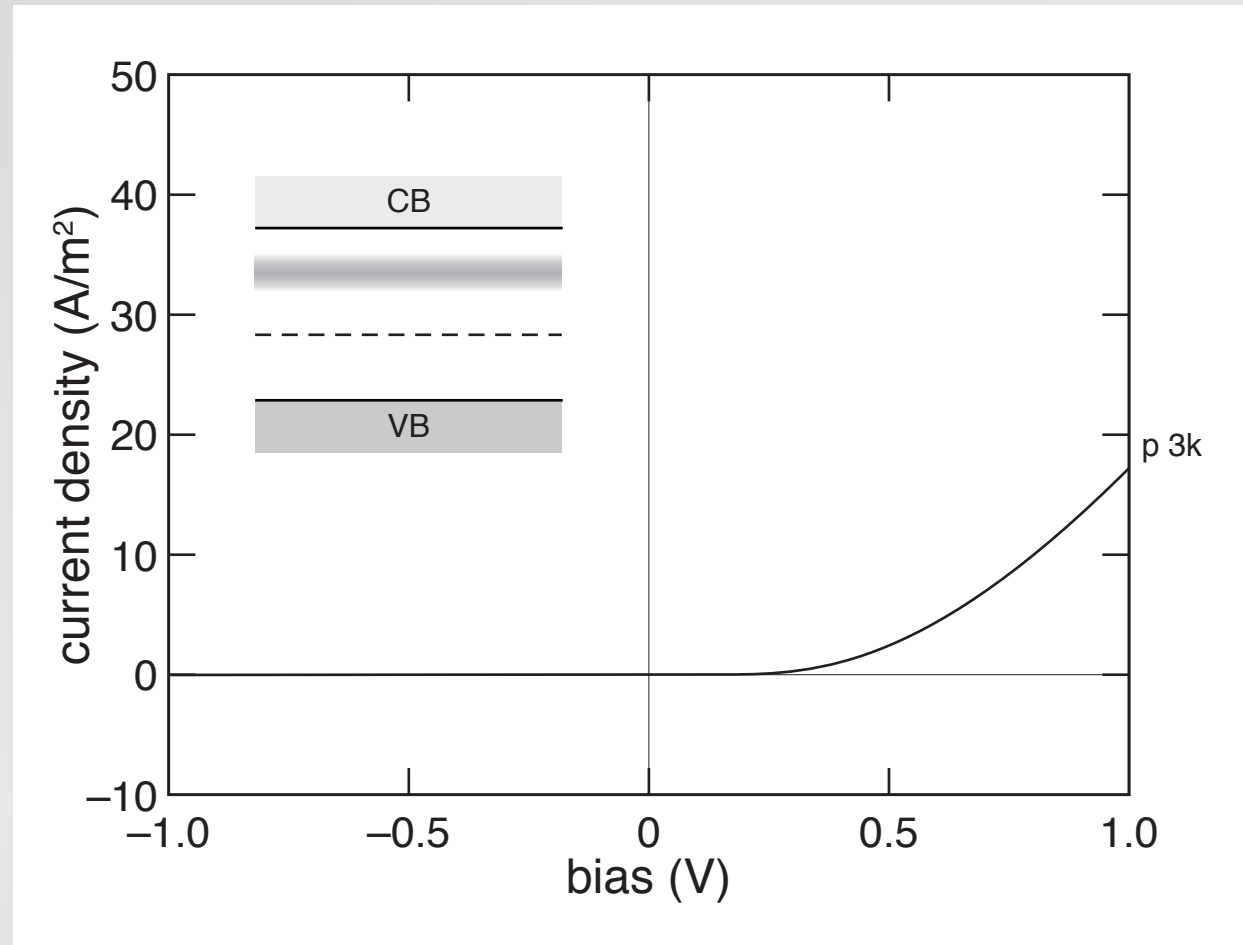

Optoelectronic properties

vary substrate doping type and resistivity

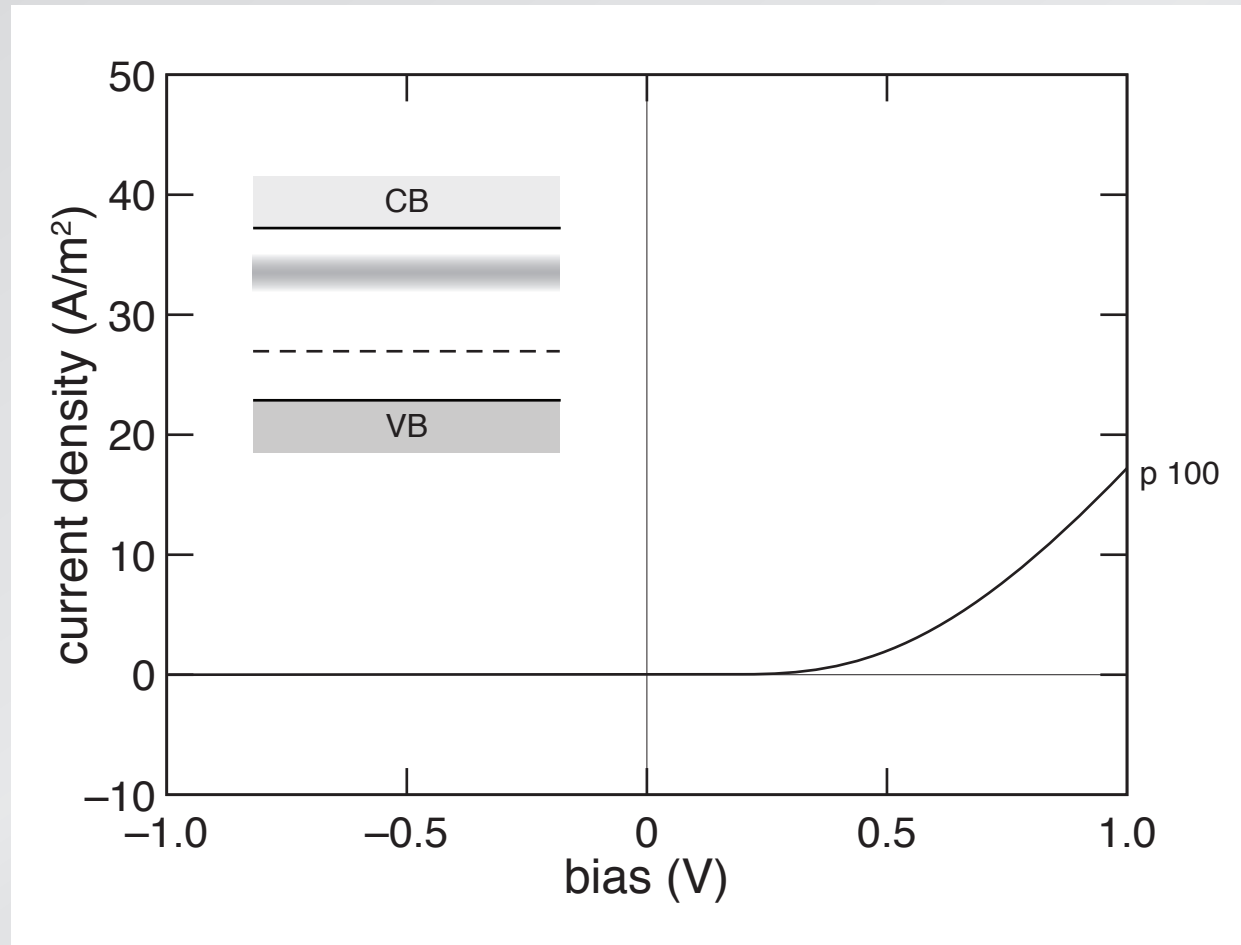

Optoelectronic properties

vary substrate doping type and resistivity

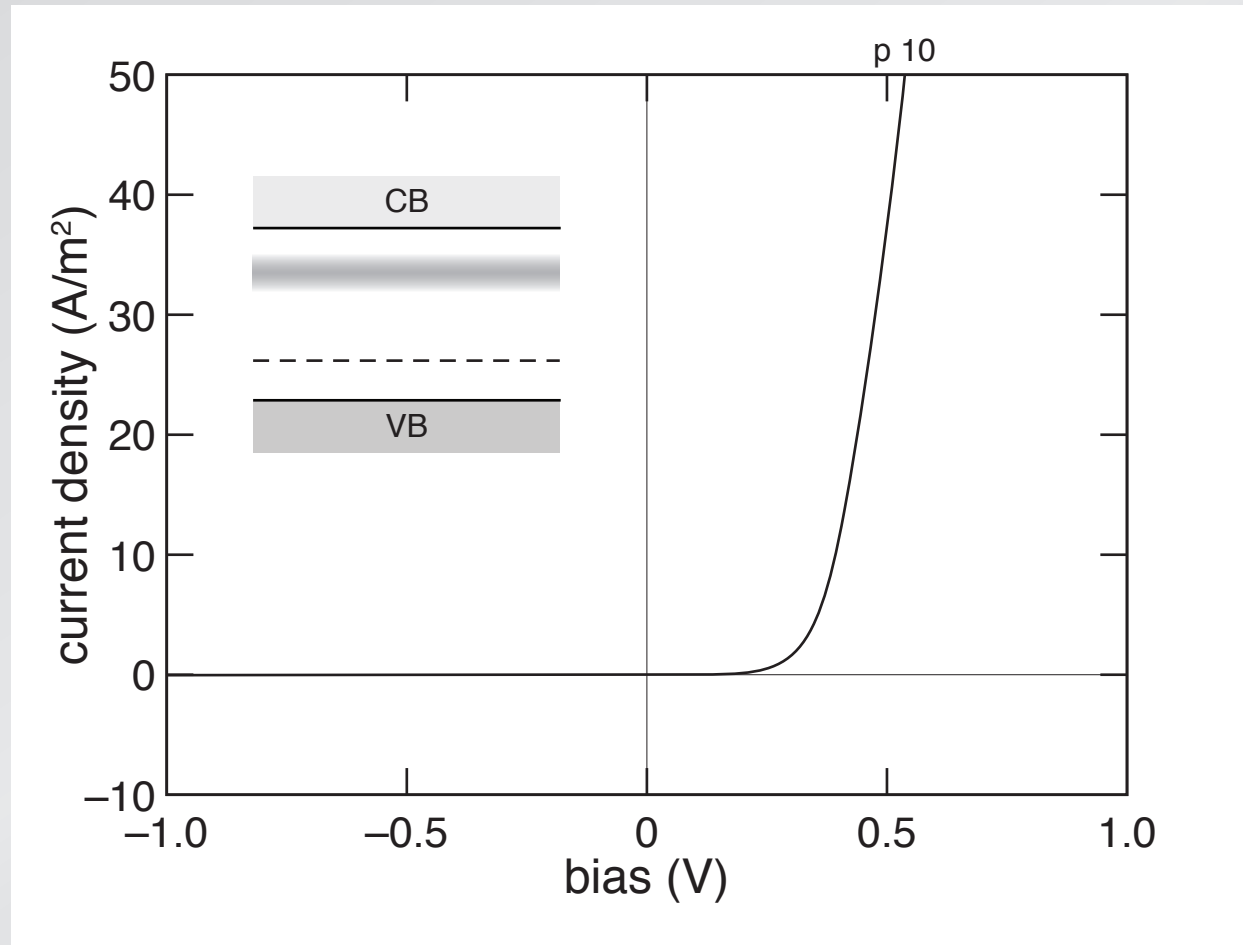

Optoelectronic properties

vary substrate doping type and resistivity

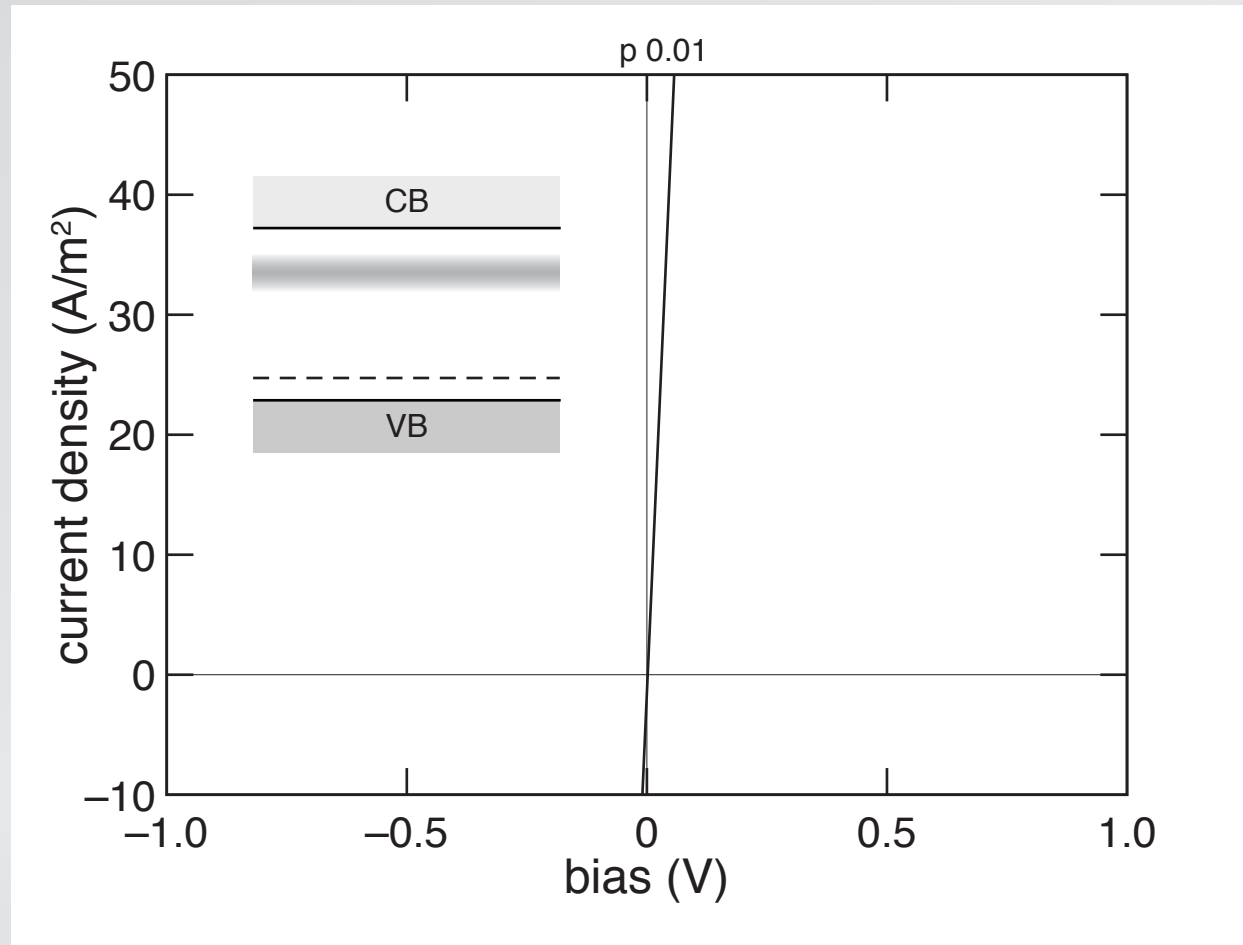

Optoelectronic properties

probe impurity states by varying Fermi level in substrate

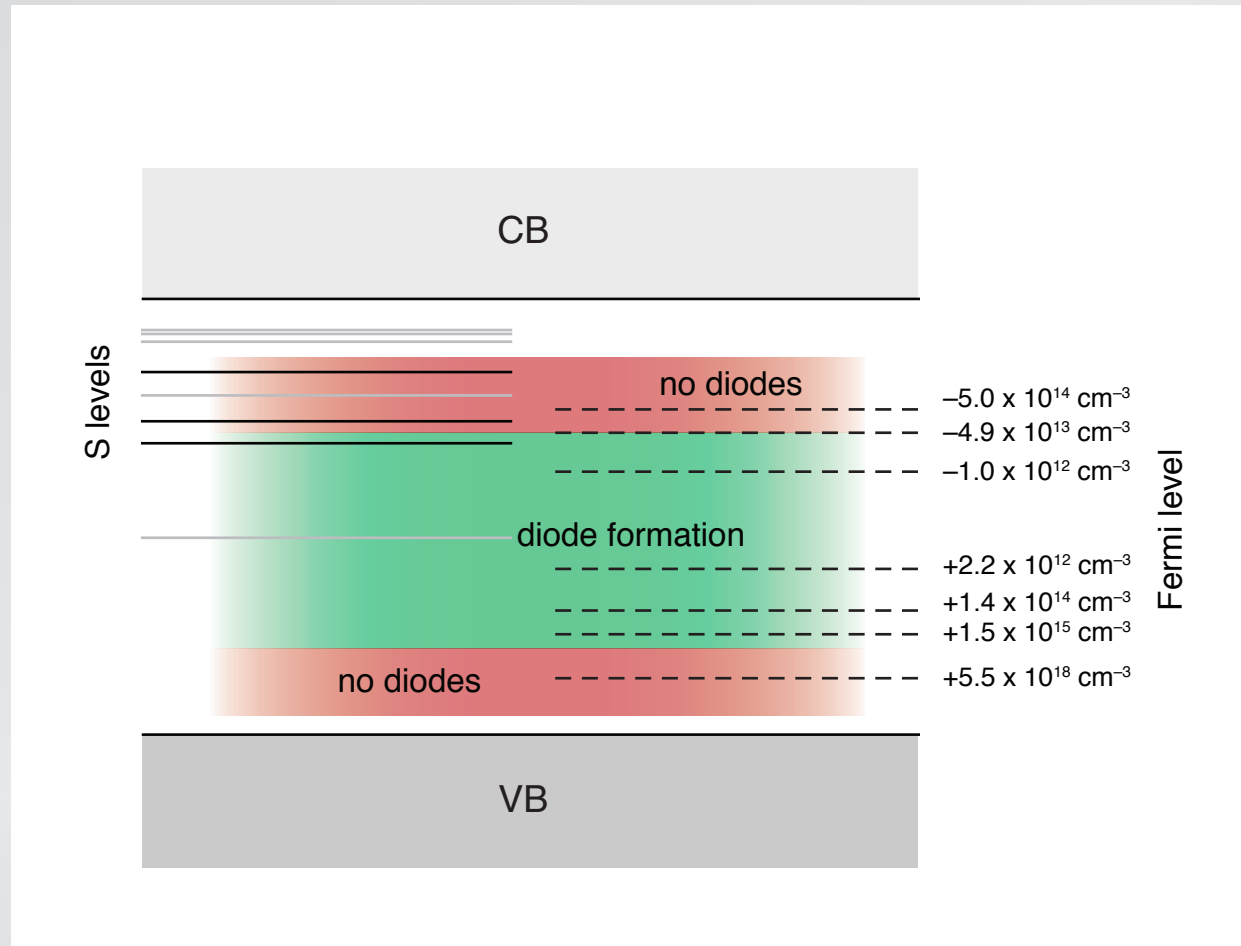

Optoelectronic properties

***I*/V behavior consistent with
impurity band between 200 and 400 meV**

Optoelectronic properties

isolate surface layer for Hall measurements

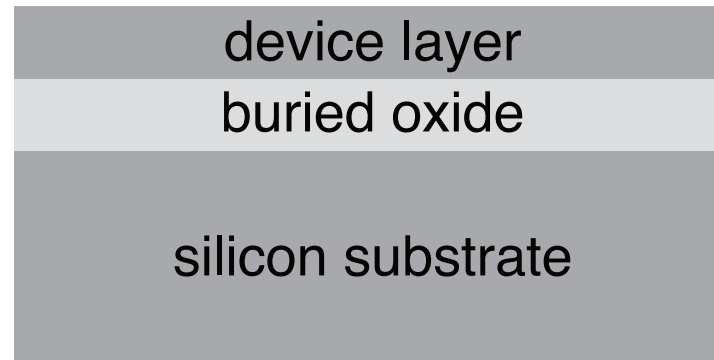

Optoelectronic properties

isolate surface layer for Hall measurements

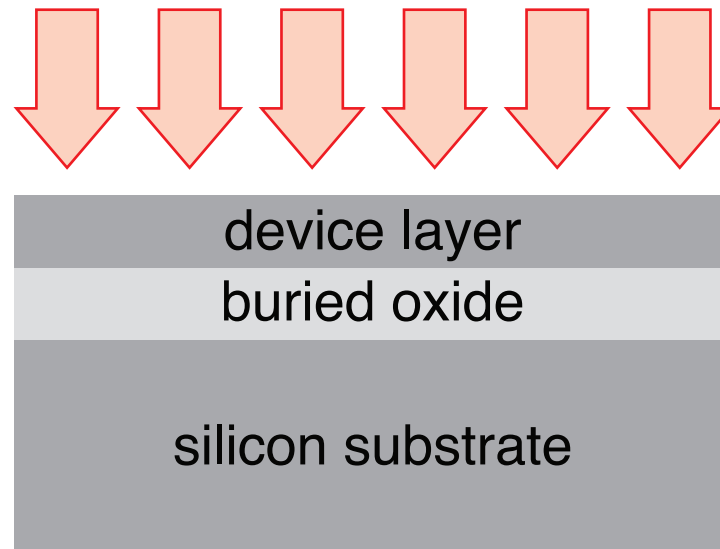

Optoelectronic properties

isolate surface layer for Hall measurements

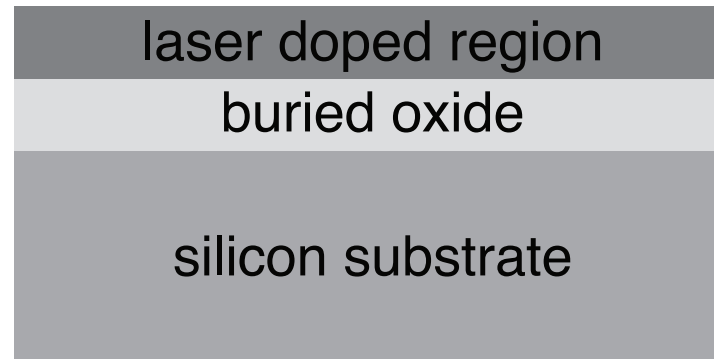

Optoelectronic properties

isolate surface layer for Hall measurements

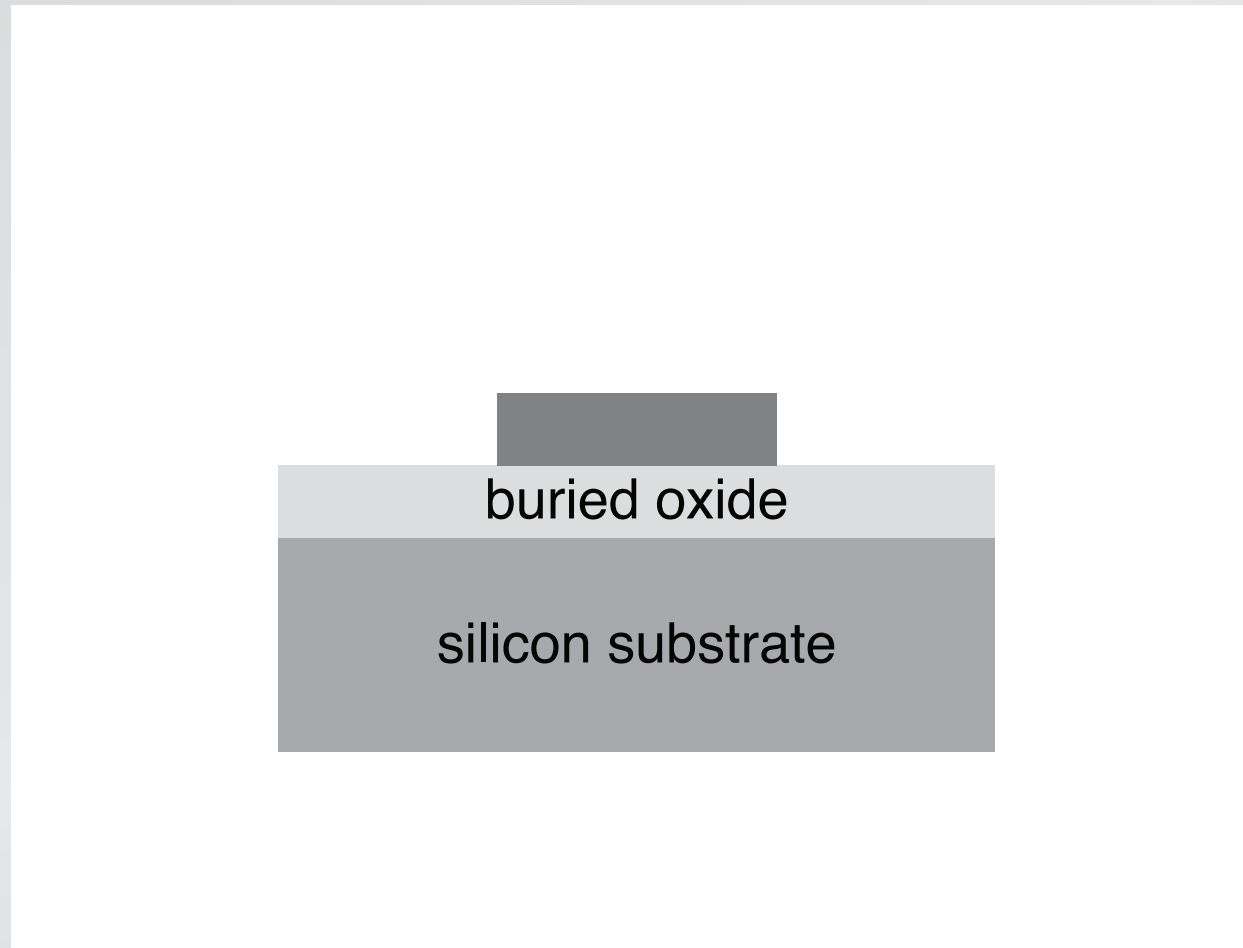

Optoelectronic properties

isolate surface layer for Hall measurements

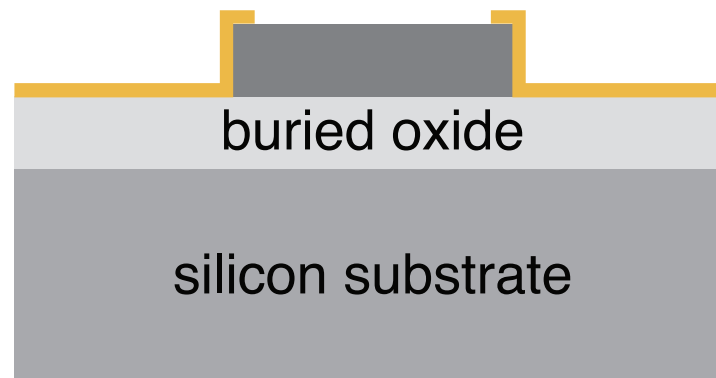

Optoelectronic properties

40 μm

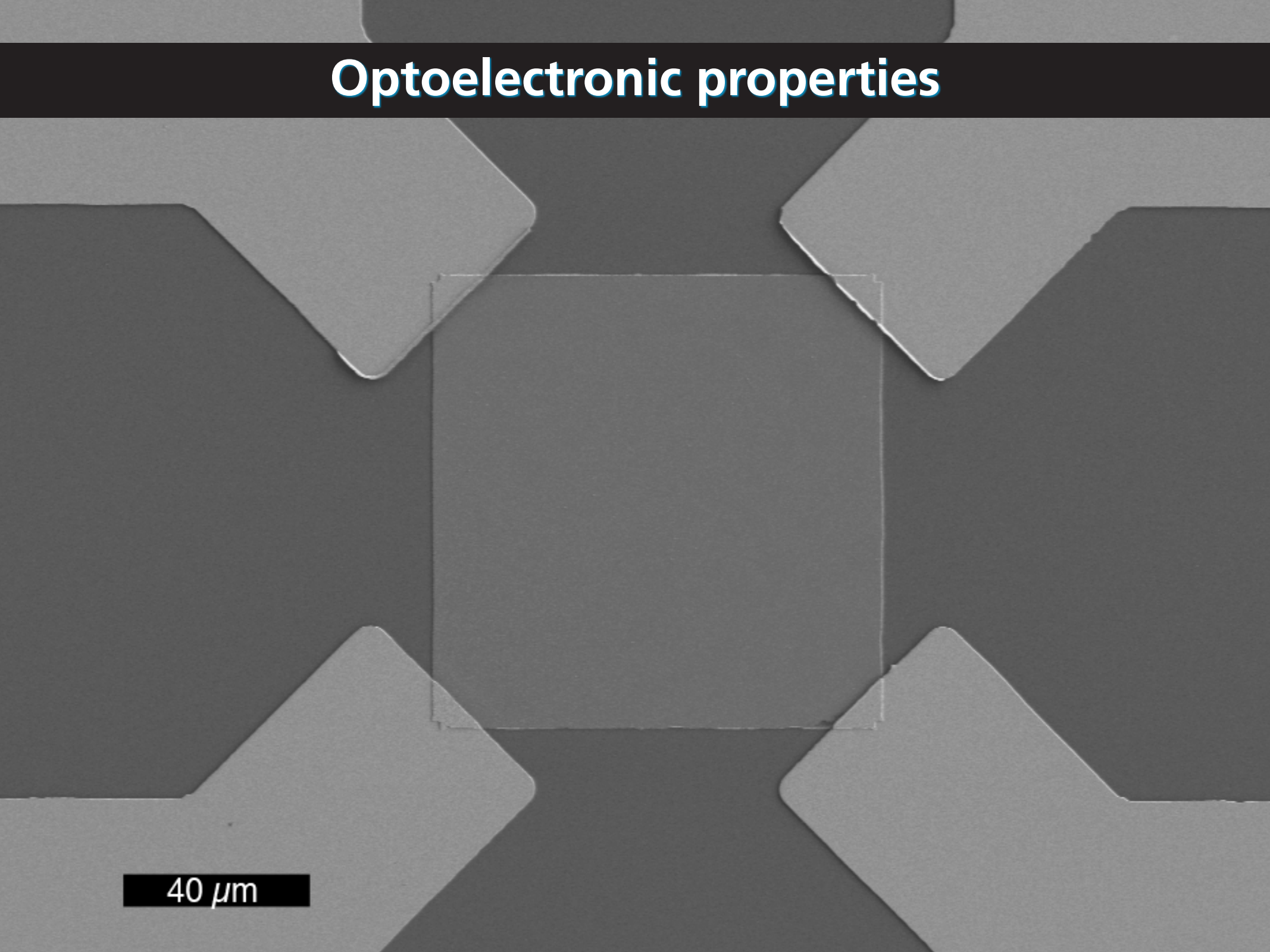
A grayscale micrograph showing a central square device. The device is surrounded by four larger, trapezoidal structures that appear to be part of a larger array or substrate. The central square is slightly darker than the surrounding areas. A scale bar in the bottom left corner indicates a length of 40 micrometers.

Optoelectronic properties

Hall measurements

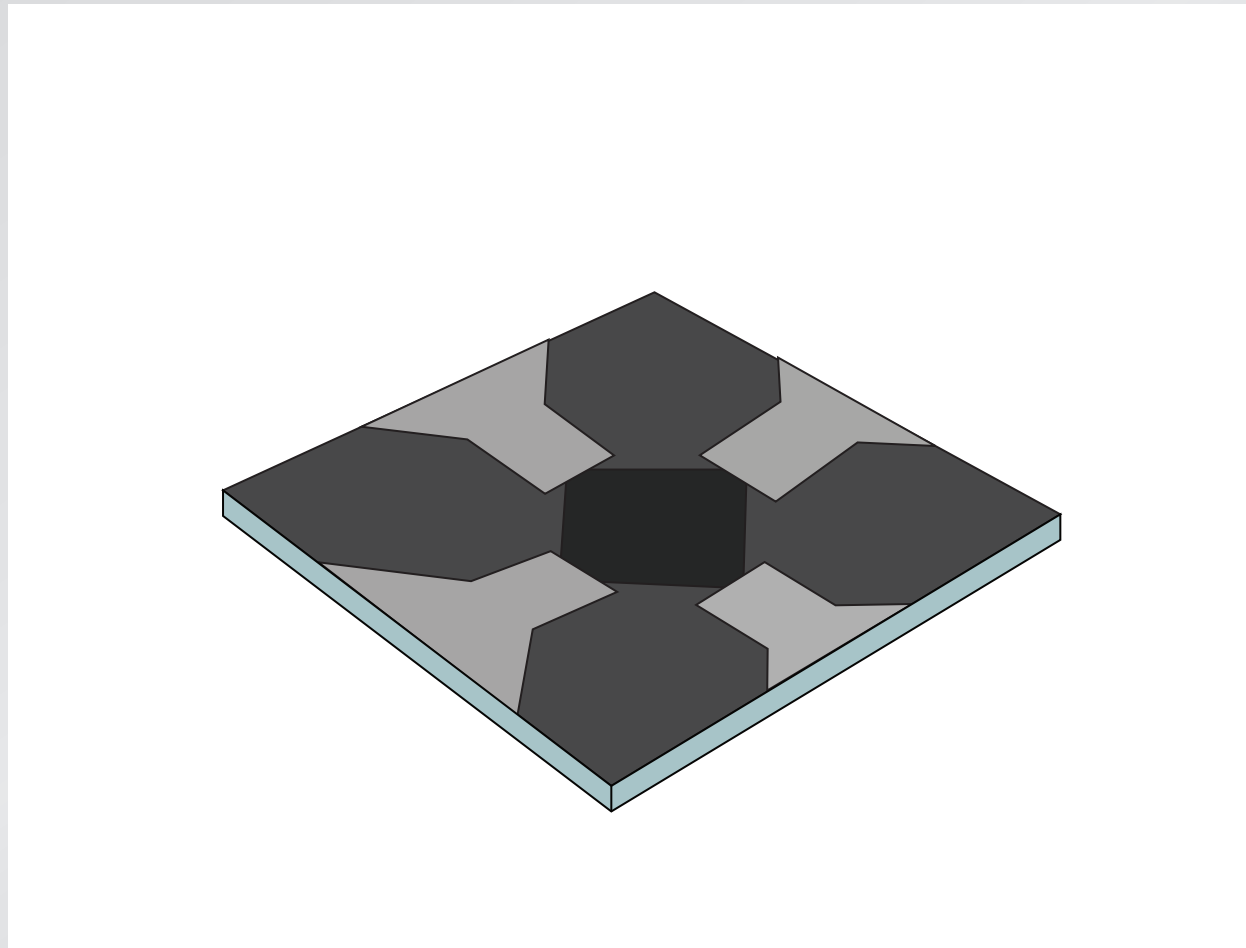

Optoelectronic properties

Hall measurements

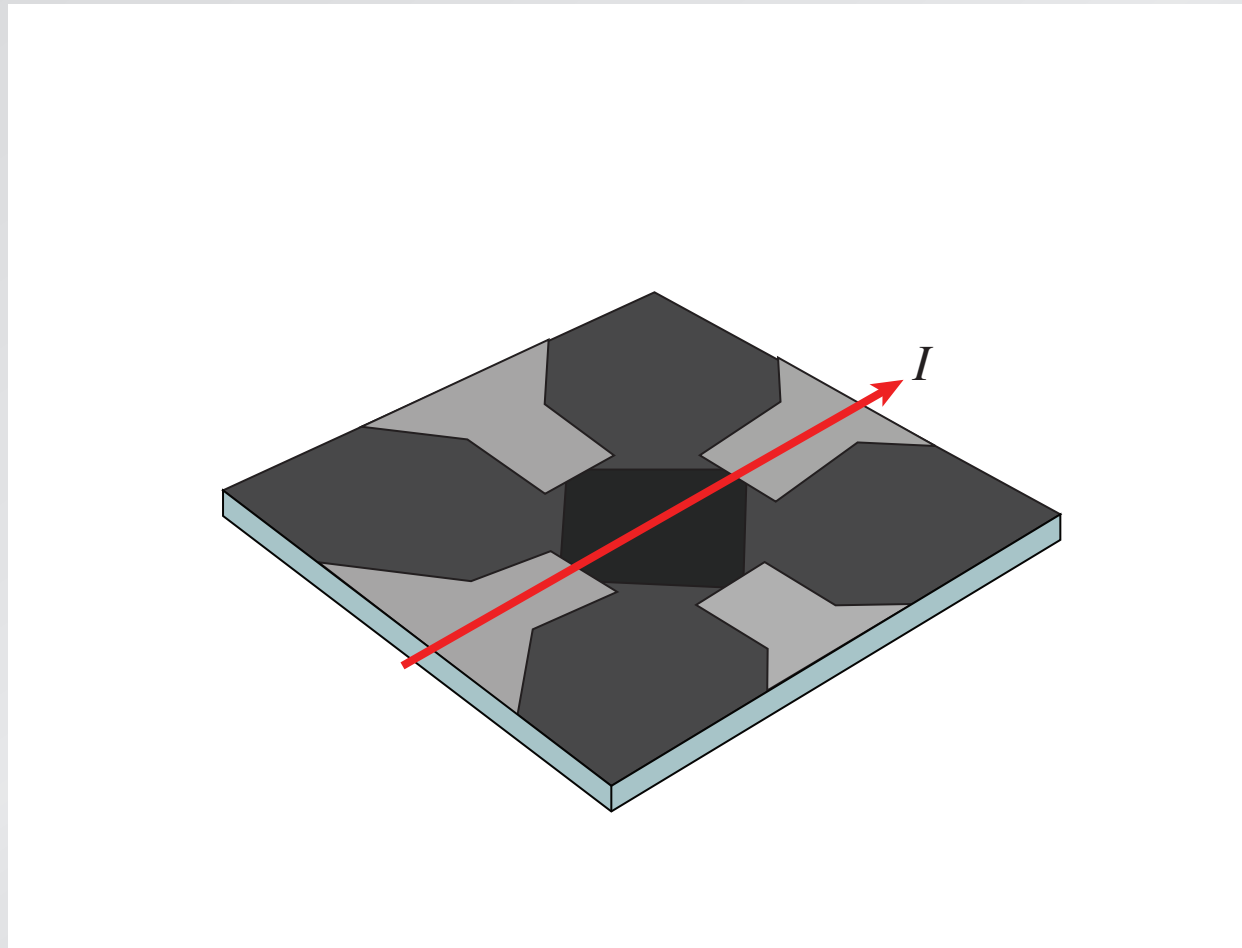

Optoelectronic properties

Hall measurements

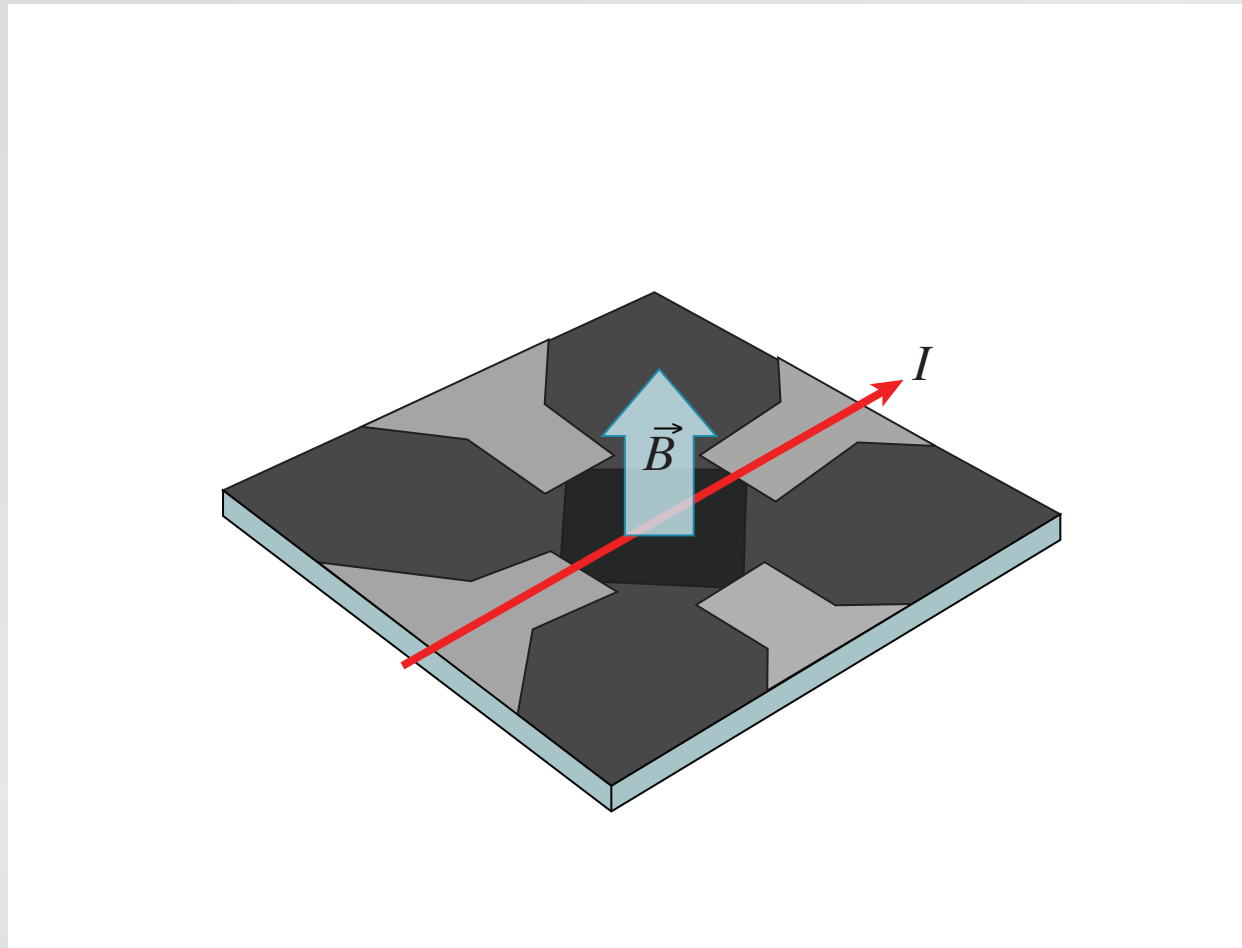

Optoelectronic properties

Hall measurements

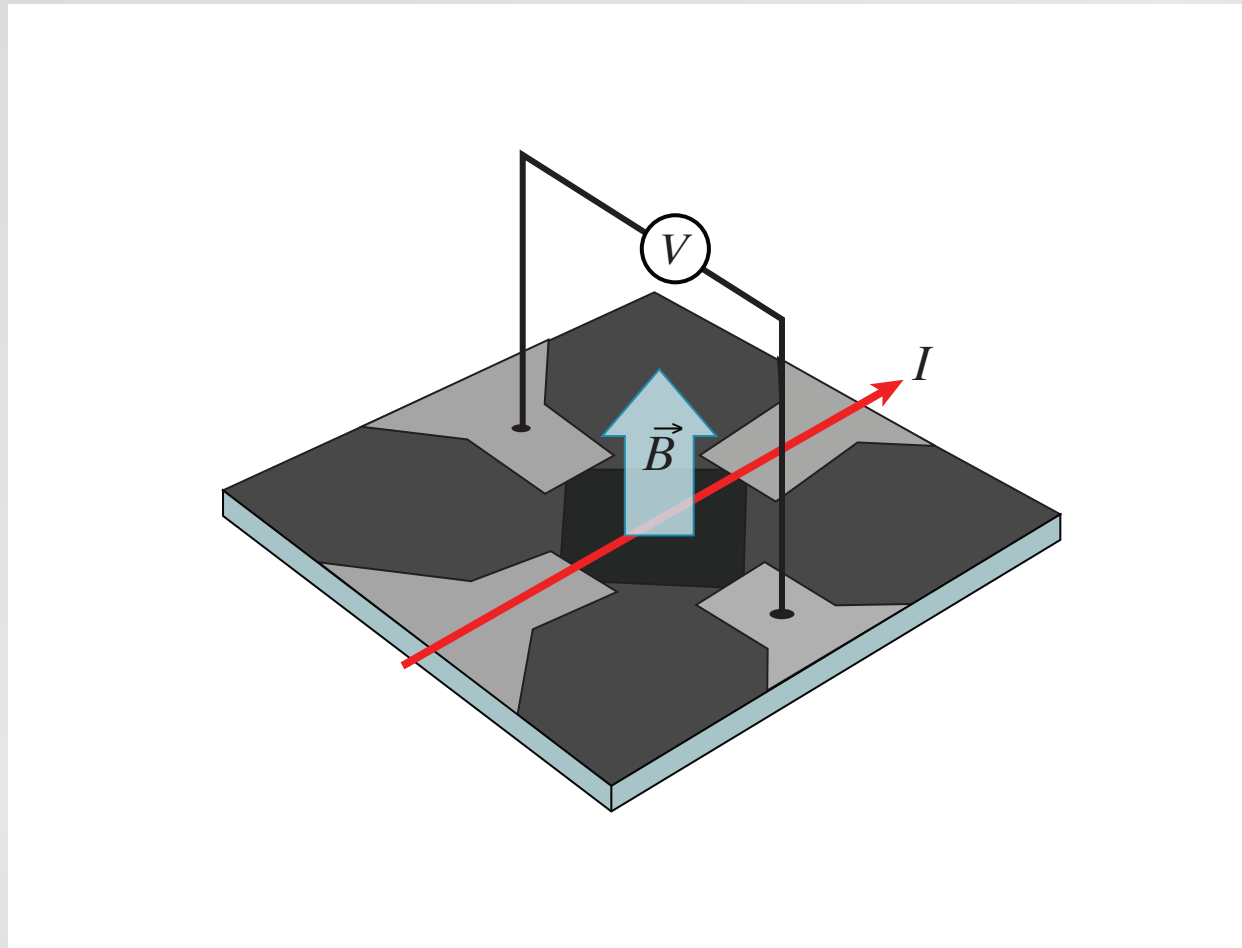

Optoelectronic properties

Hall measurements

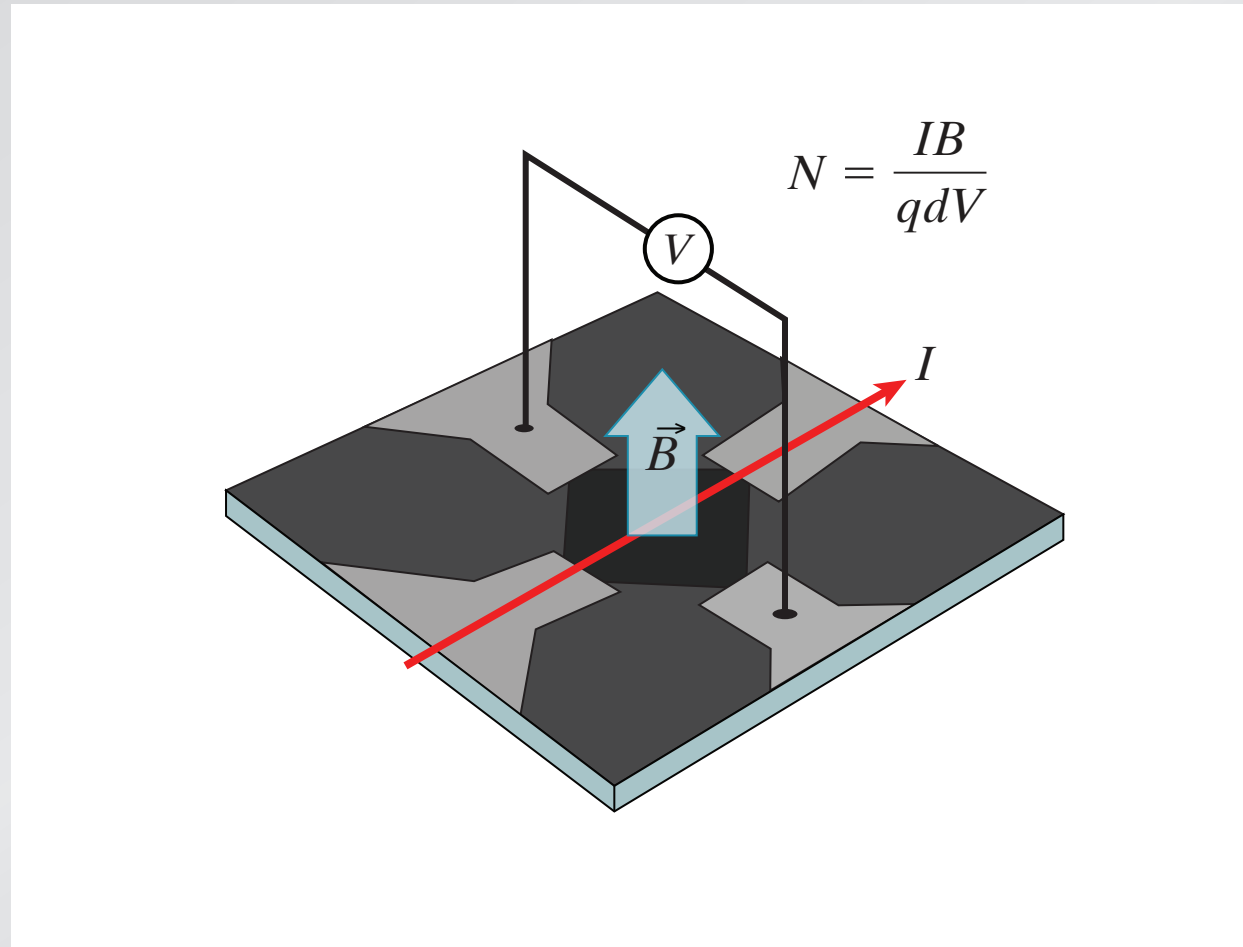

Optoelectronic properties

Hall measurements

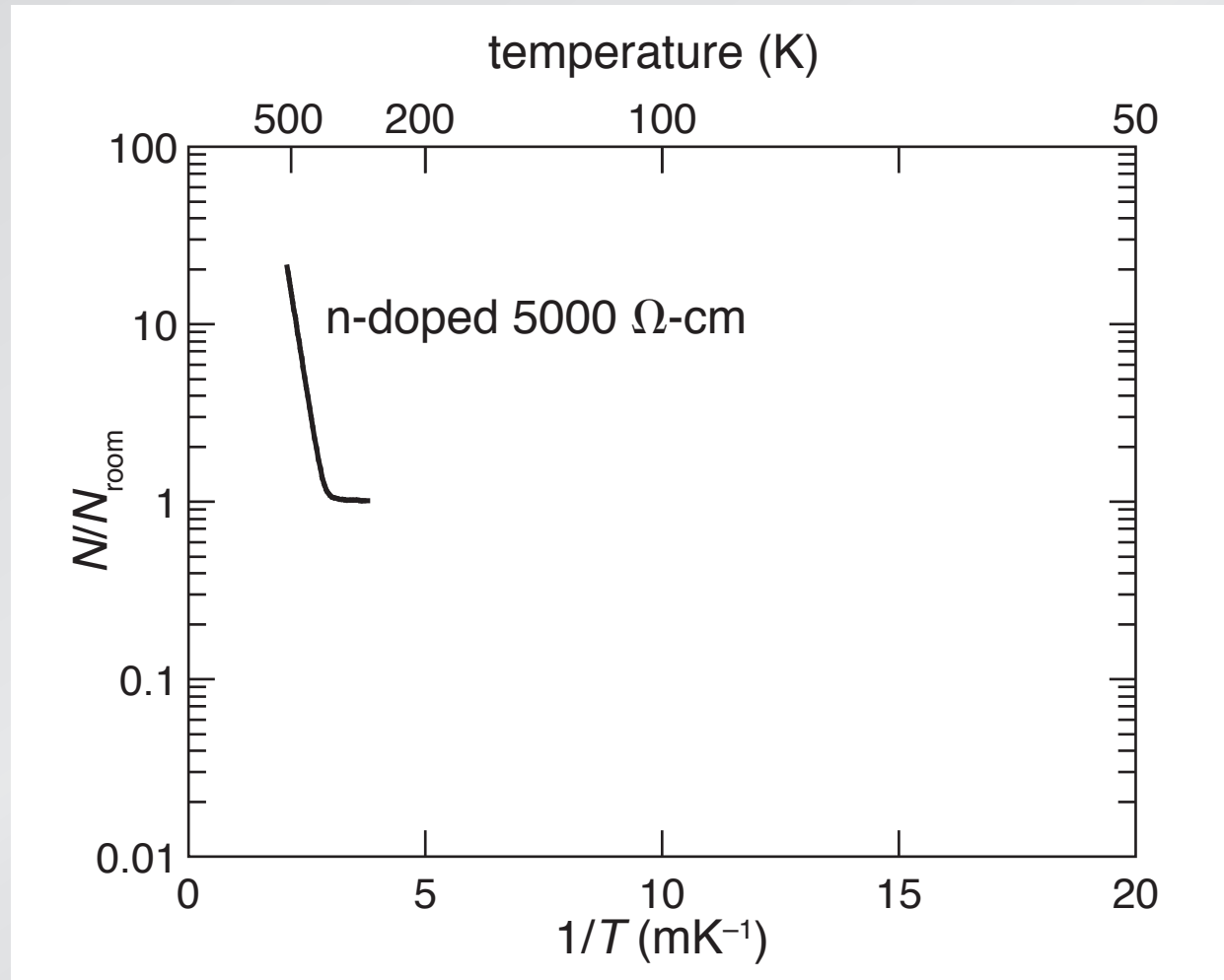

Optoelectronic properties

Hall measurements

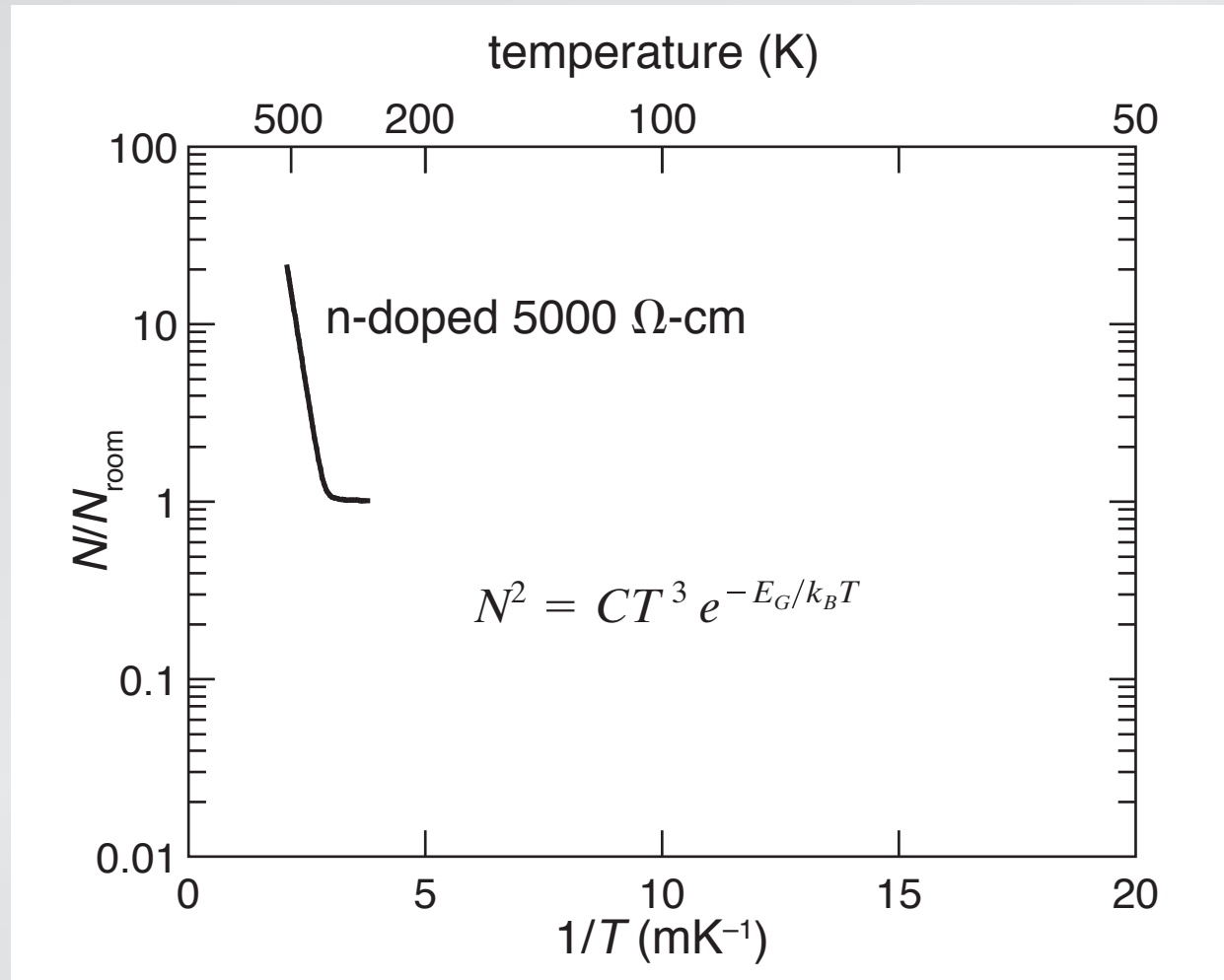

Optoelectronic properties

Hall measurements

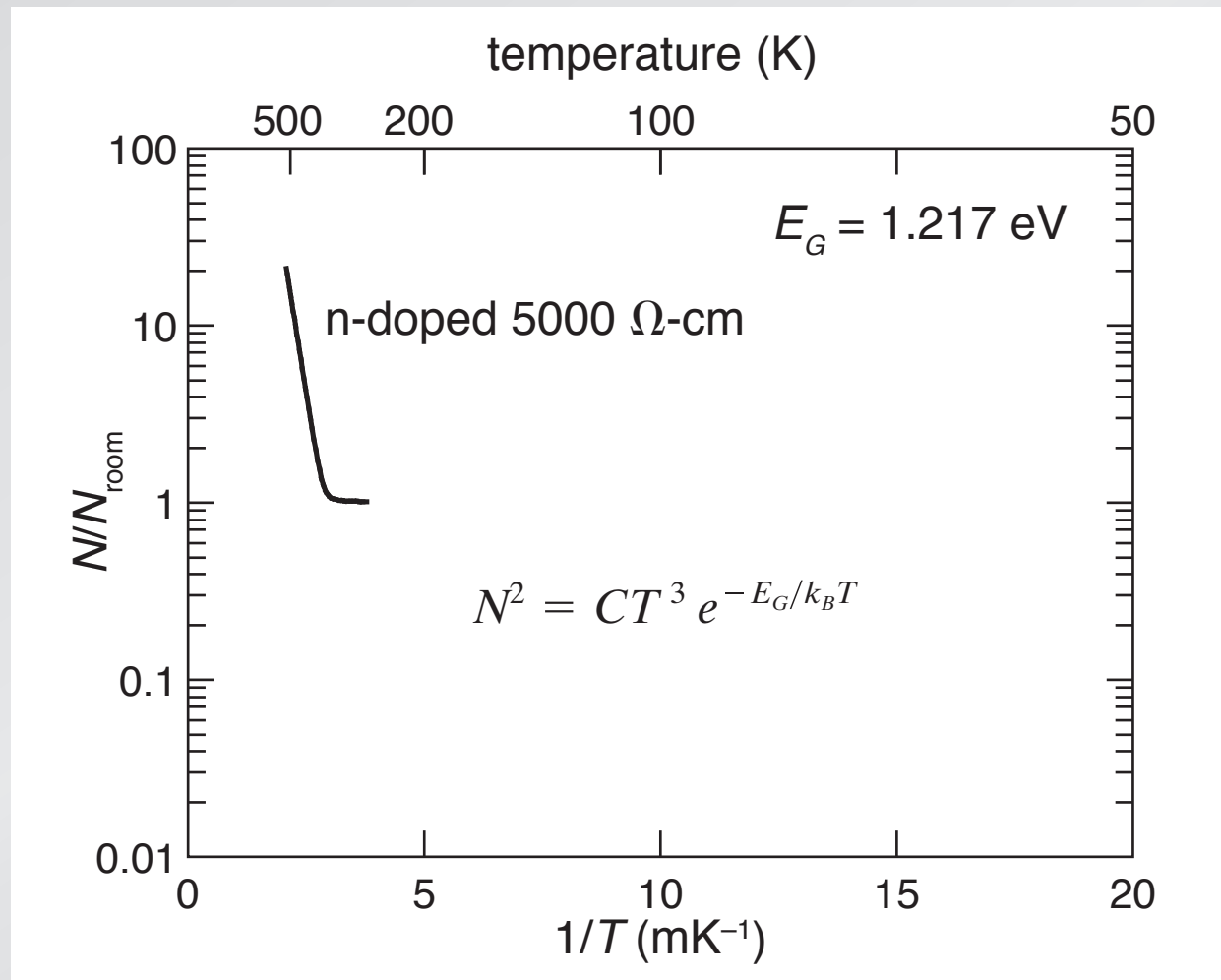

Optoelectronic properties

Hall measurements

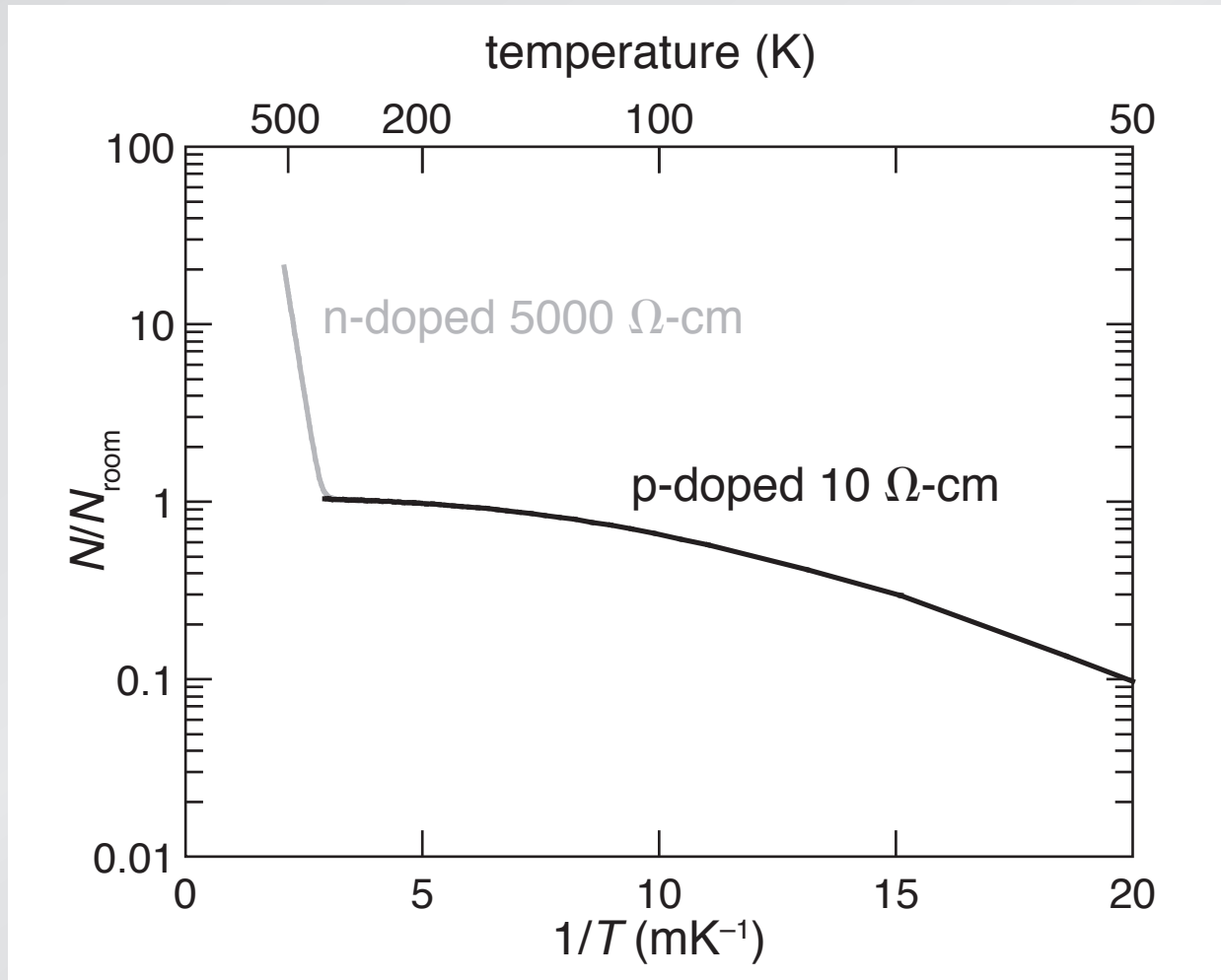

Optoelectronic properties

Hall measurements

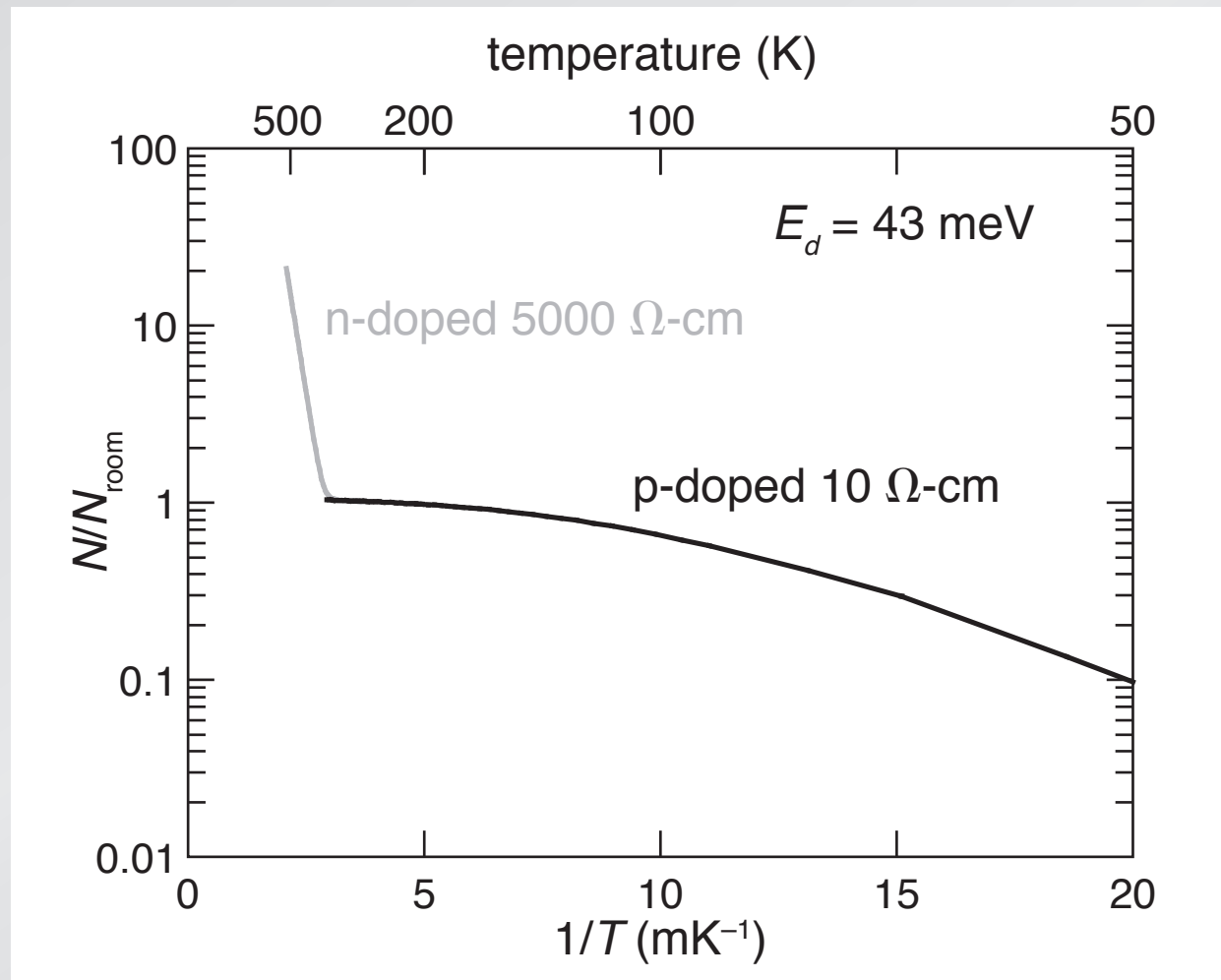

Optoelectronic properties

Hall measurements

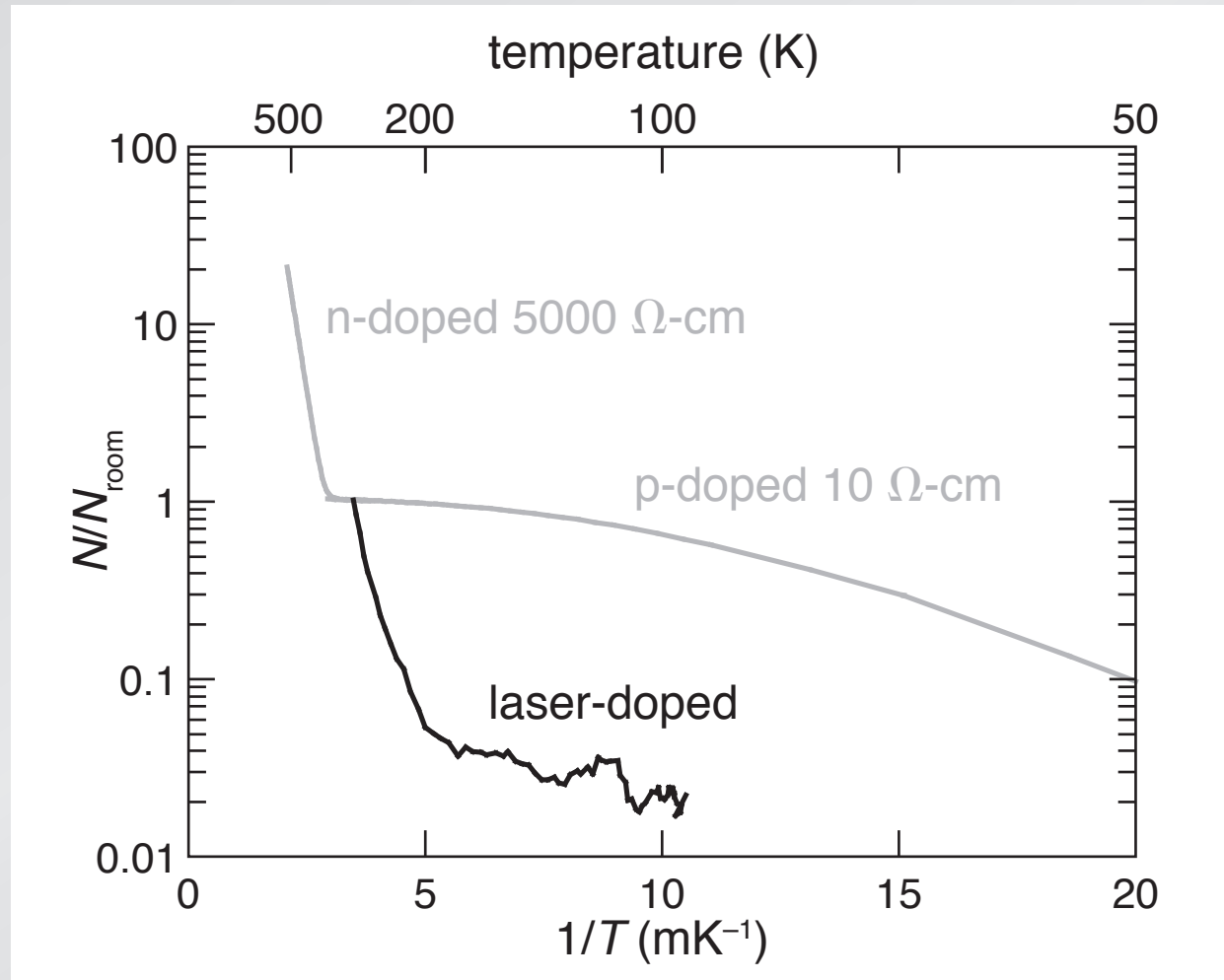

Optoelectronic properties

Hall measurements

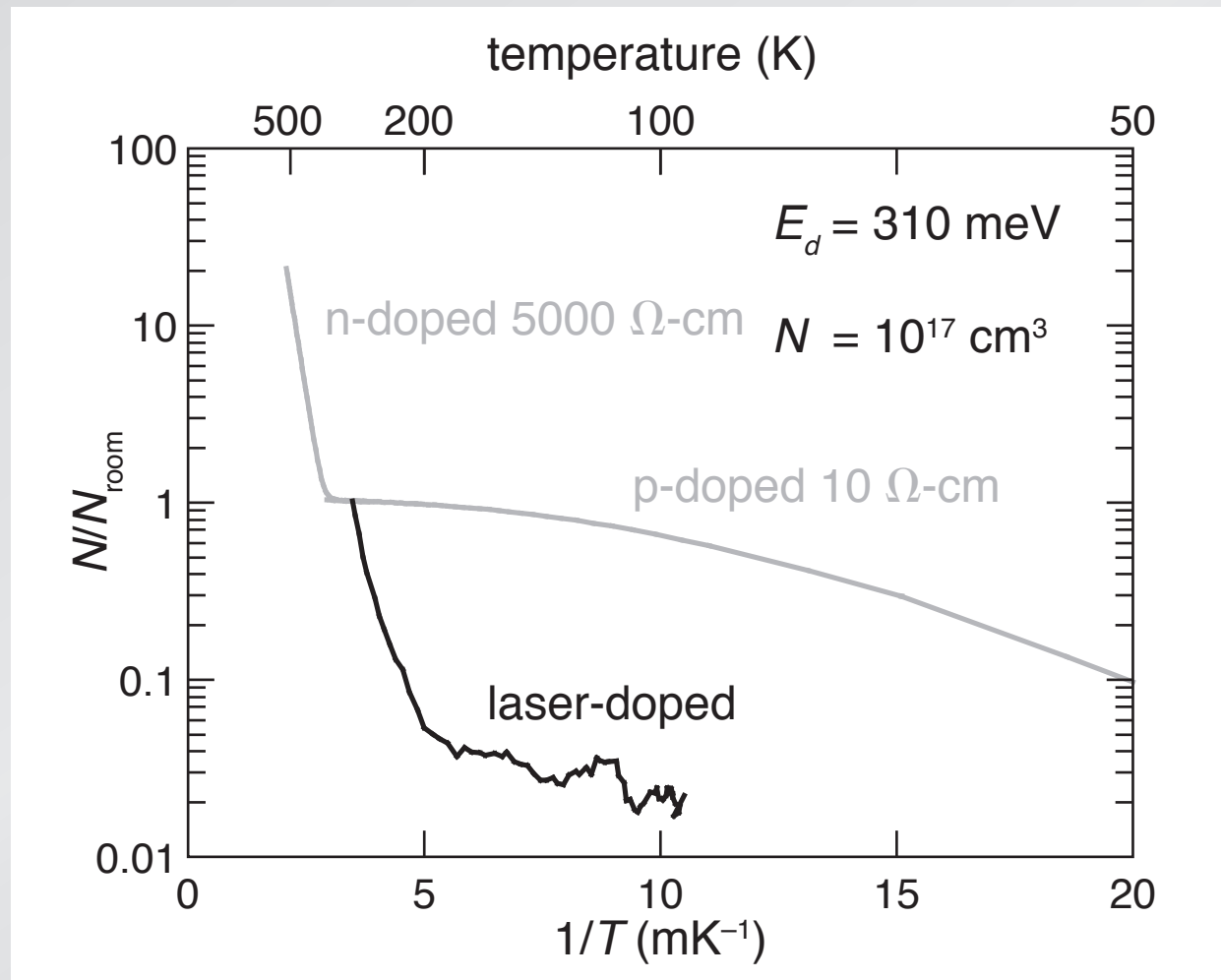

Optoelectronic properties

impurity (donor) band centered at 310 meV

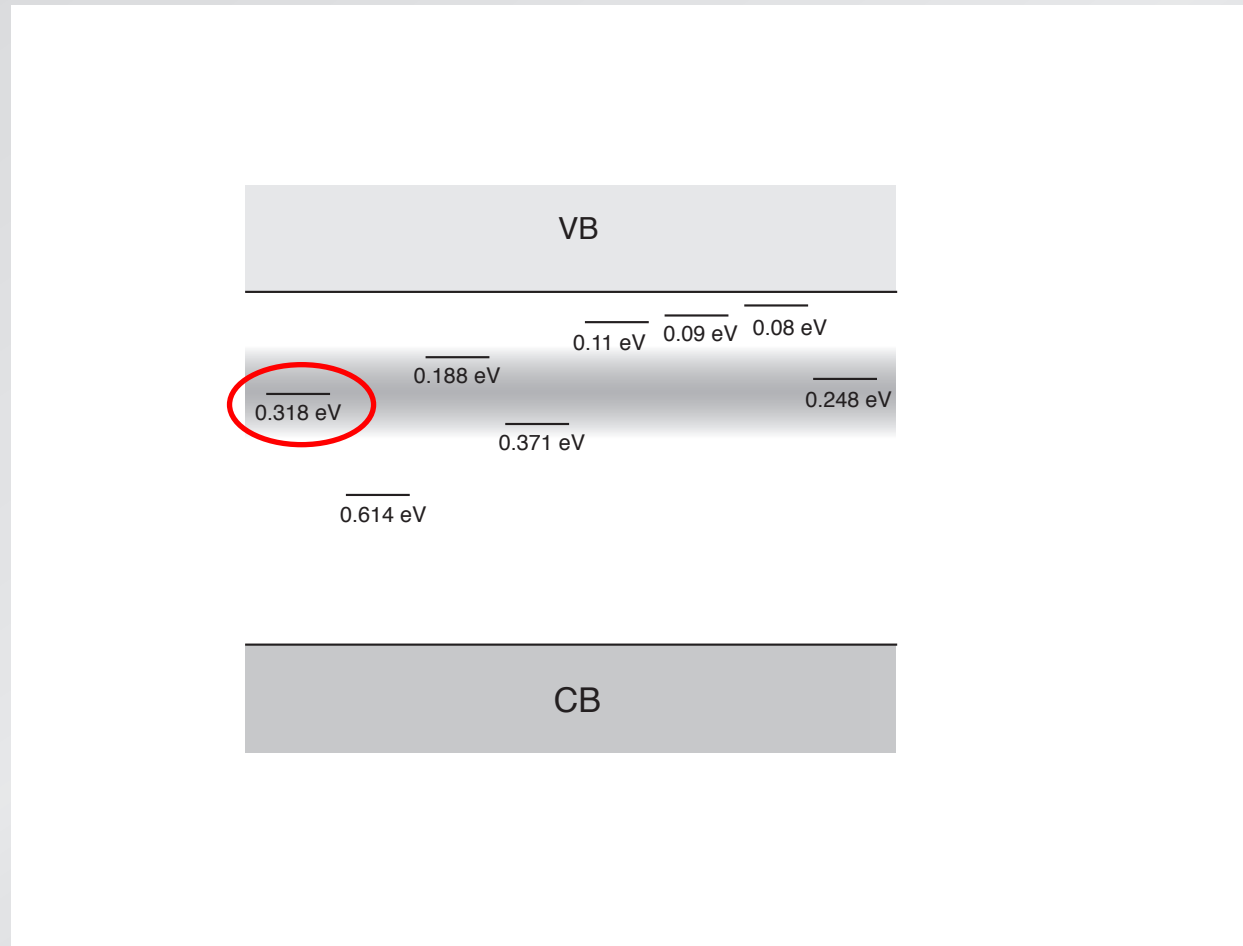

Optoelectronic properties

majority carrier mobility

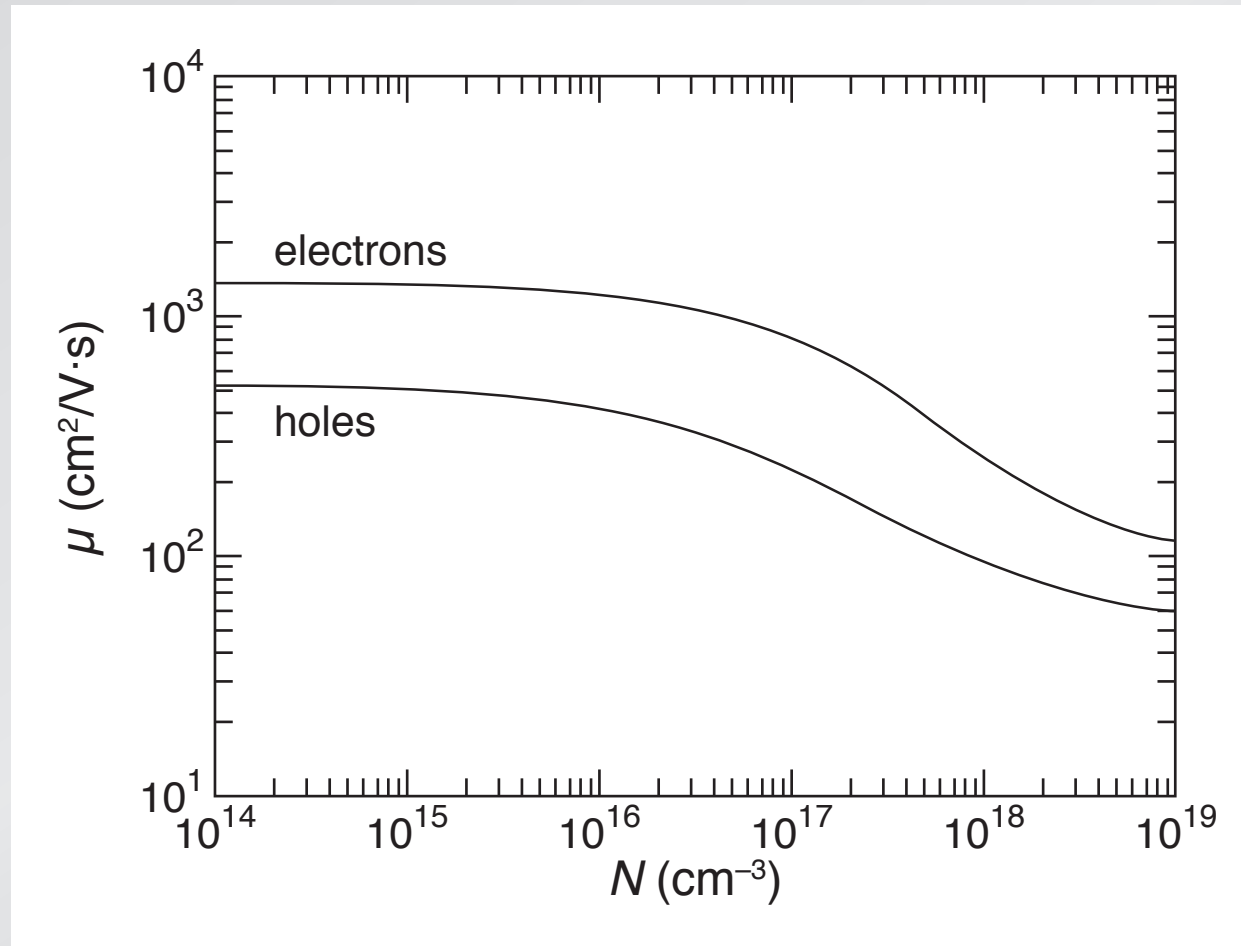

Caughey *et al.*, Proc. IEEE 55, 2192 (1967)

Optoelectronic properties

majority carrier mobility

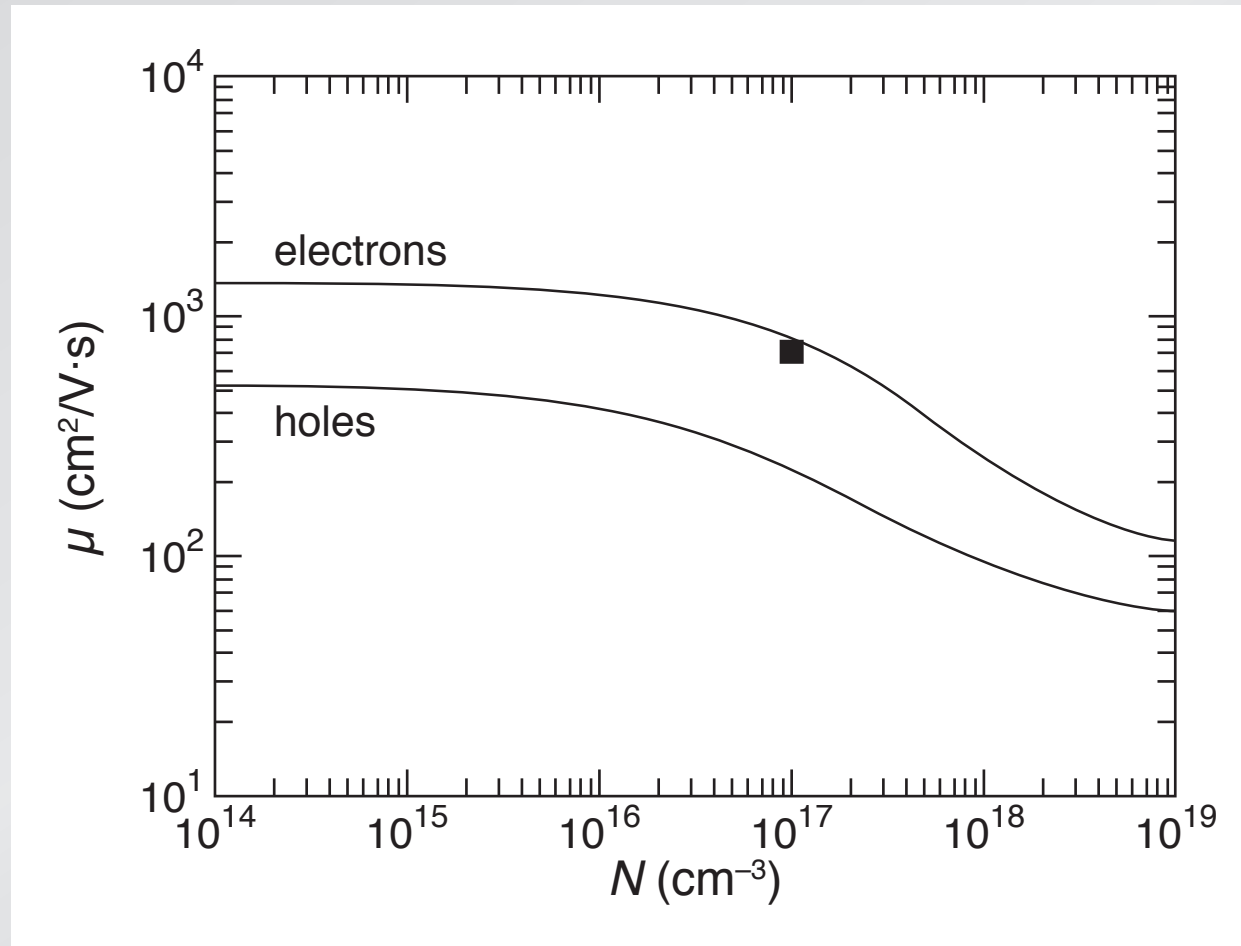

Caughey *et al.*, Proc. IEEE 55, 2192 (1967)

Optoelectronic properties

Things to keep in mind

- IR absorption rolls off around 8 μm
- 1 in 10^3 sulfur atoms are ionized donors at 300 K
- all data indicate these S donors are substitutional

Outline

- structure
- optoelectronic properties
- devices

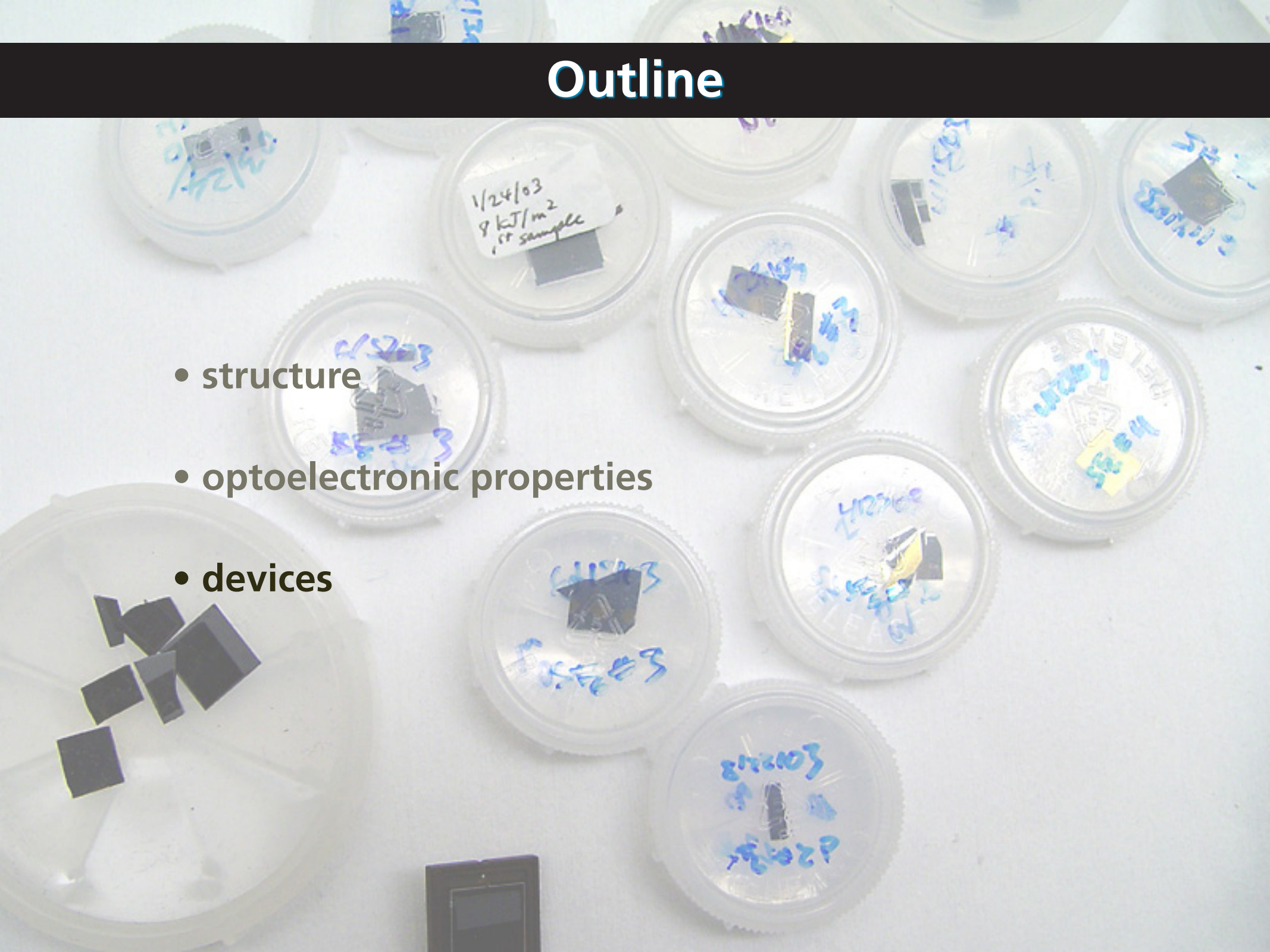

Devices

responsivity

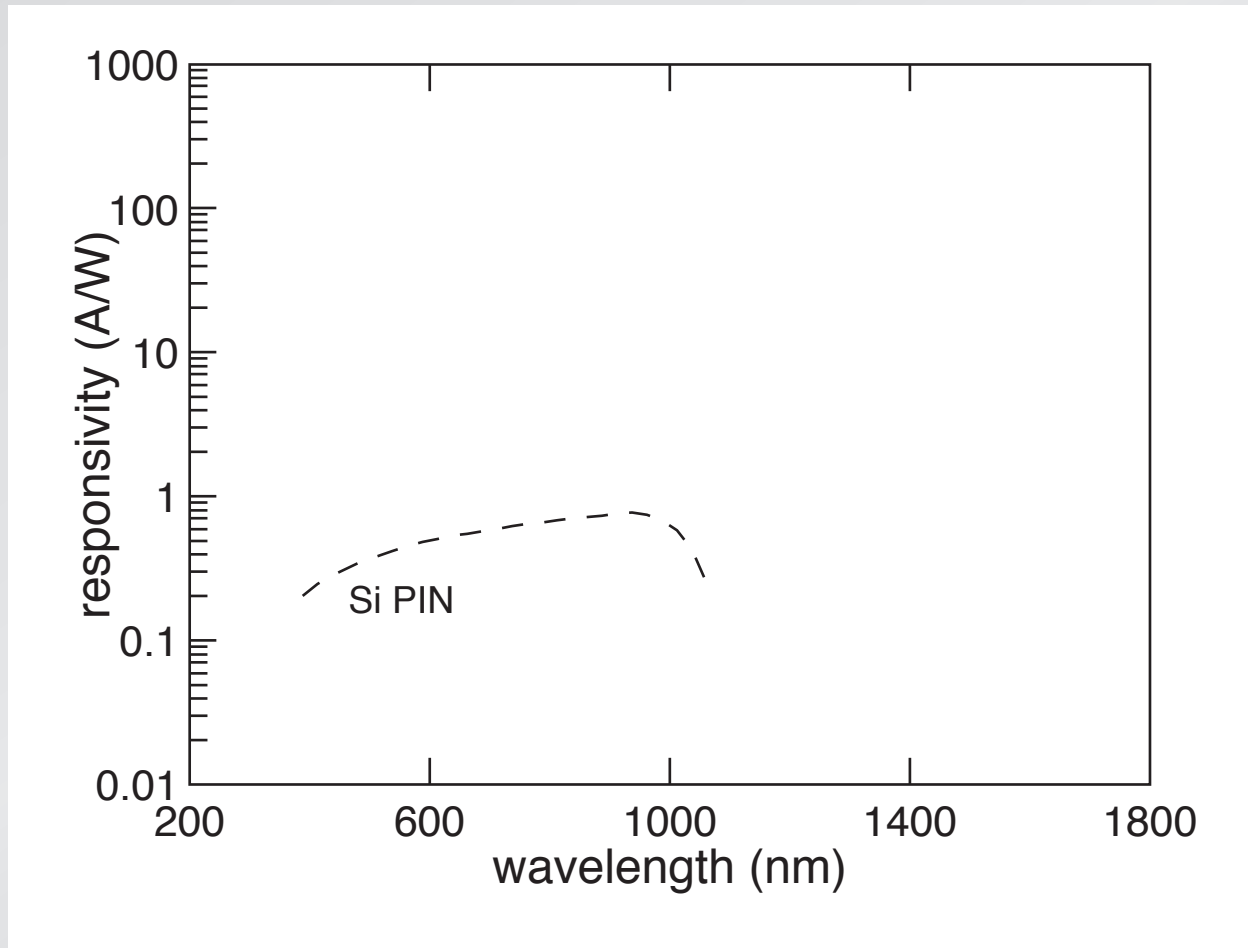

Devices

responsivity

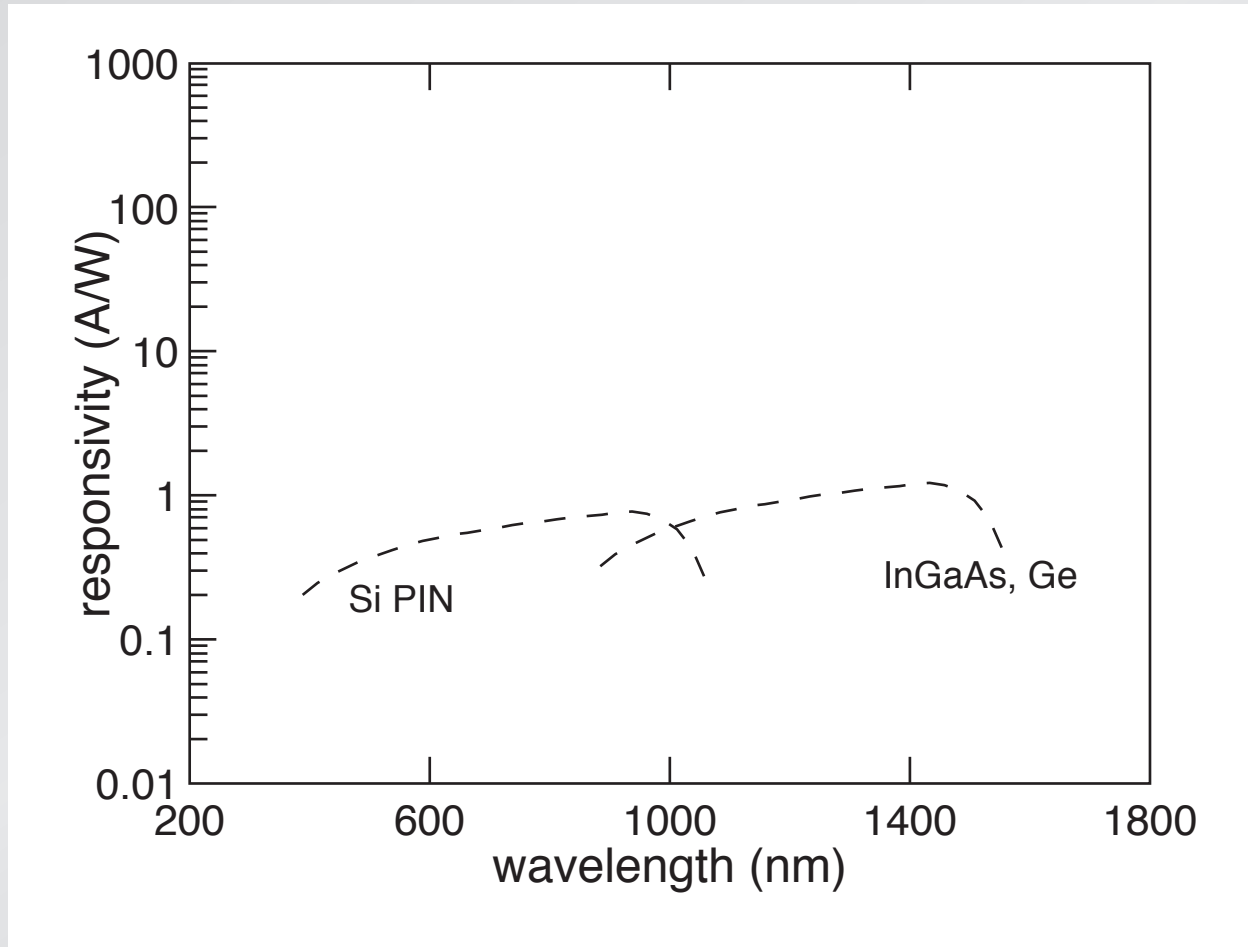

Devices

responsivity

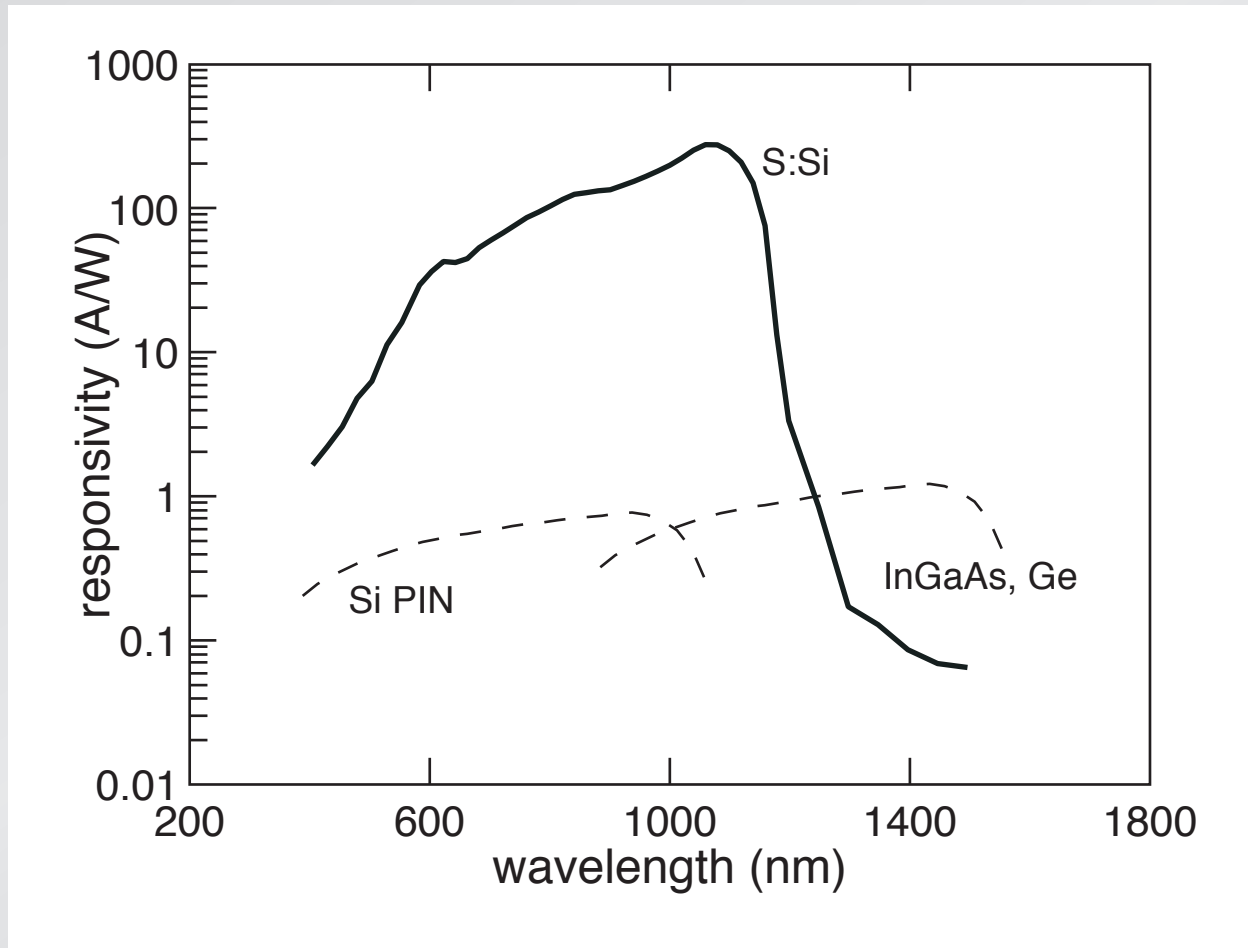

Devices

responsivity

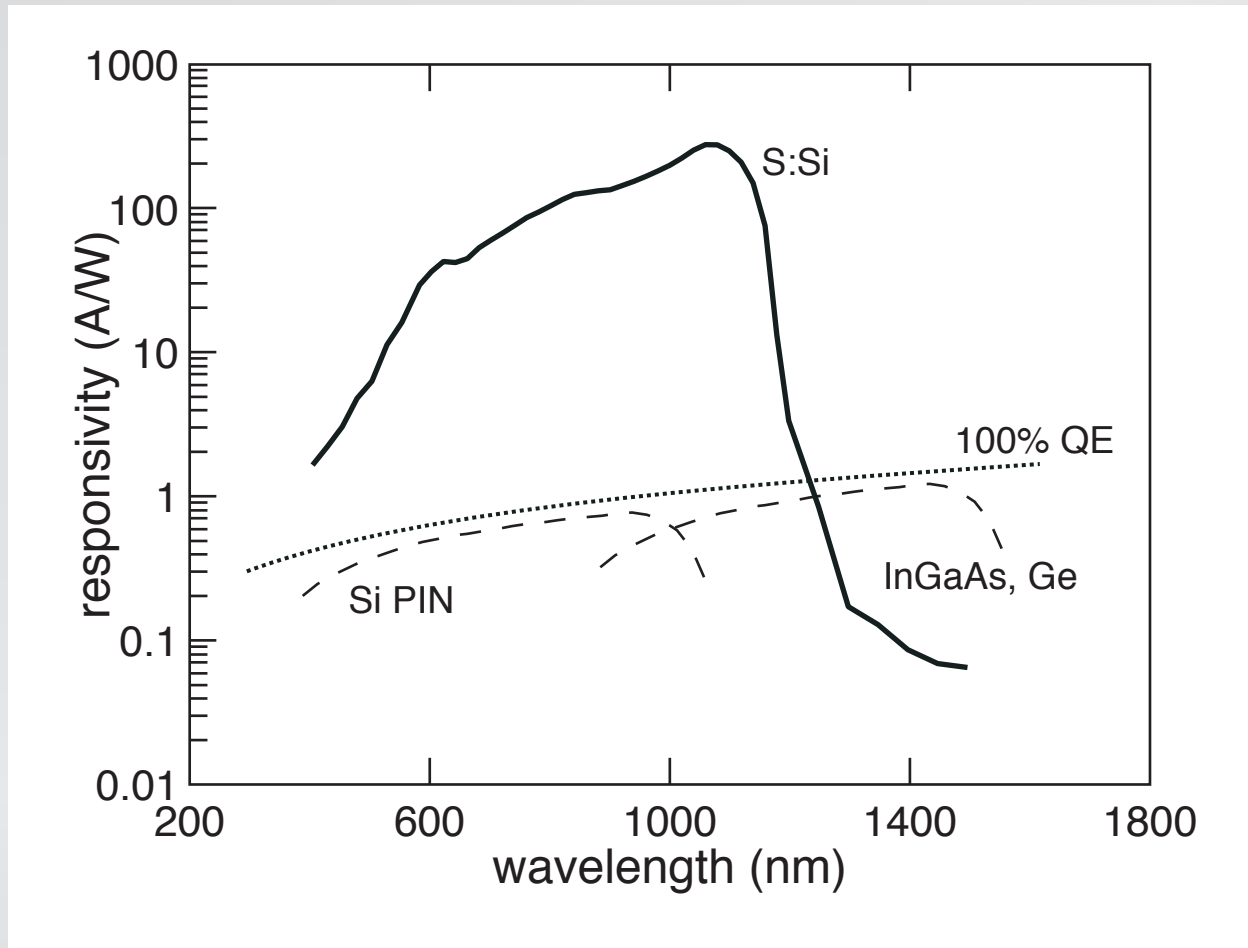

Devices

responsivity

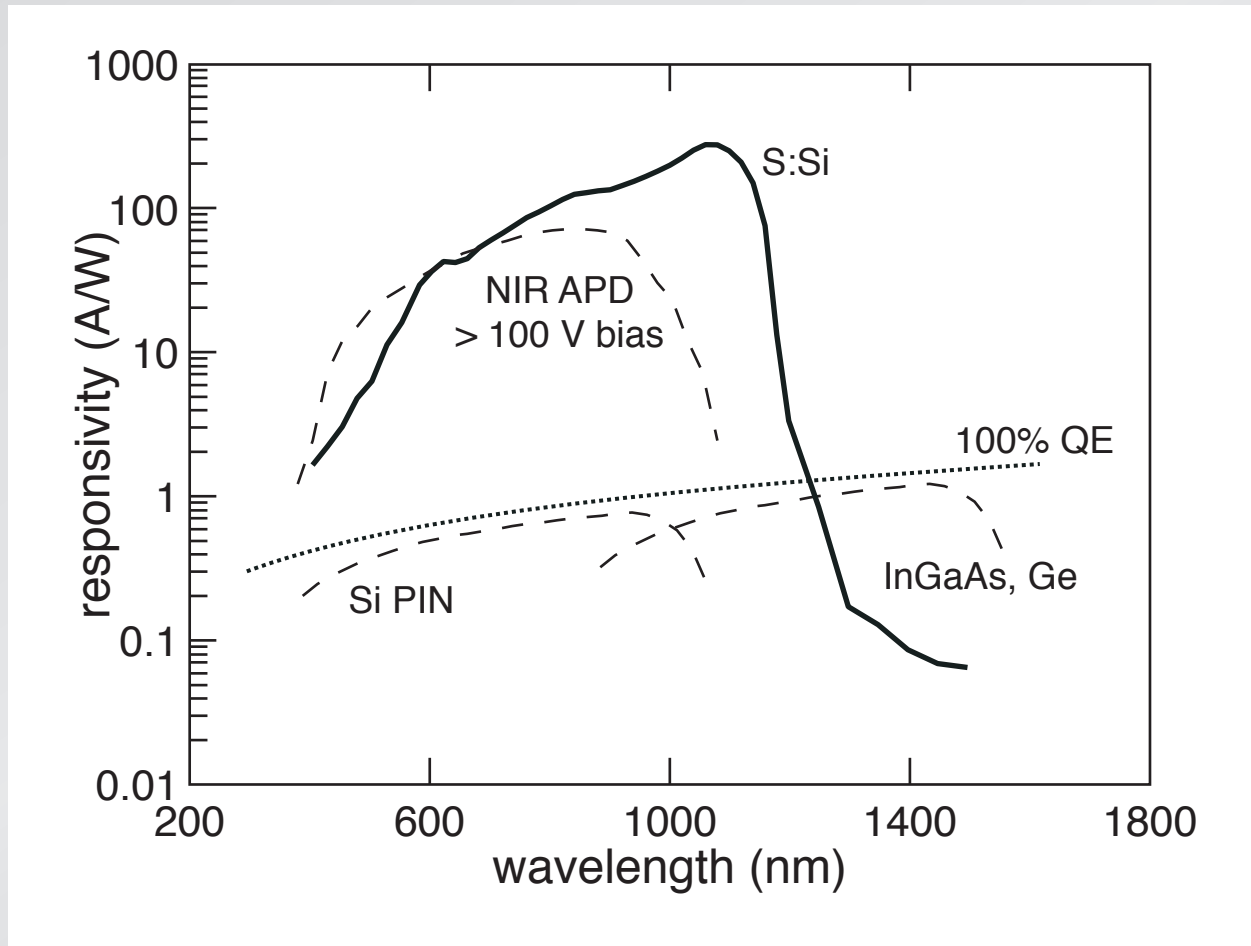

Devices

What causes gain?

- **impact excitation (avalanching)**
- **carrier lifetime \gg transit time (photoconductive gain)**
- **some other mechanism**

Devices

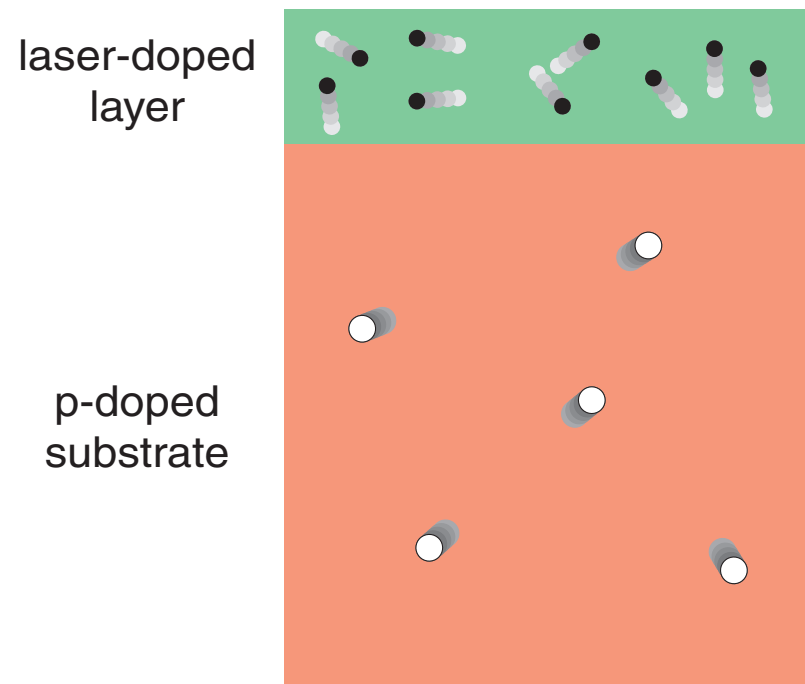

"pl junction"

Devices

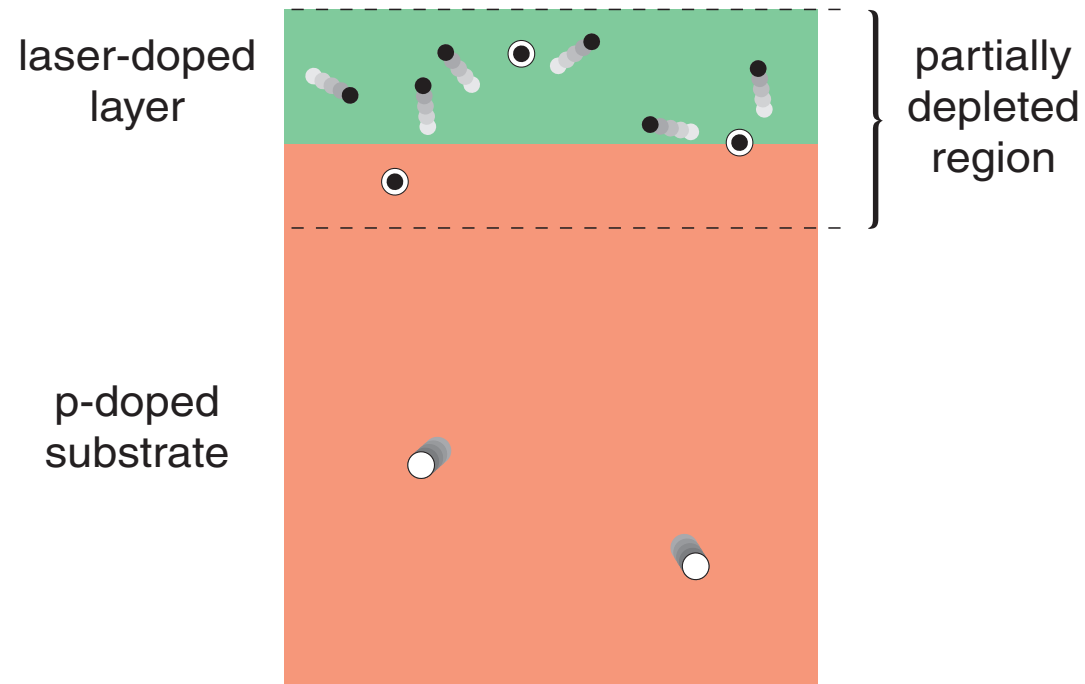

formation of partially depleted region

Devices

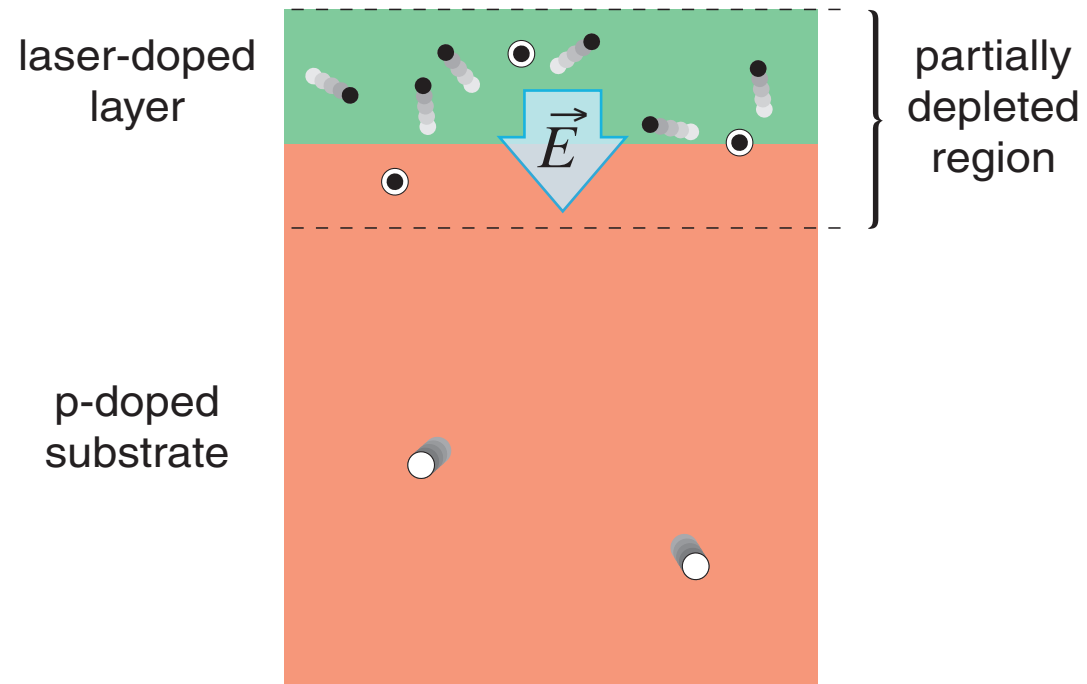

formation of partially depleted region

Devices

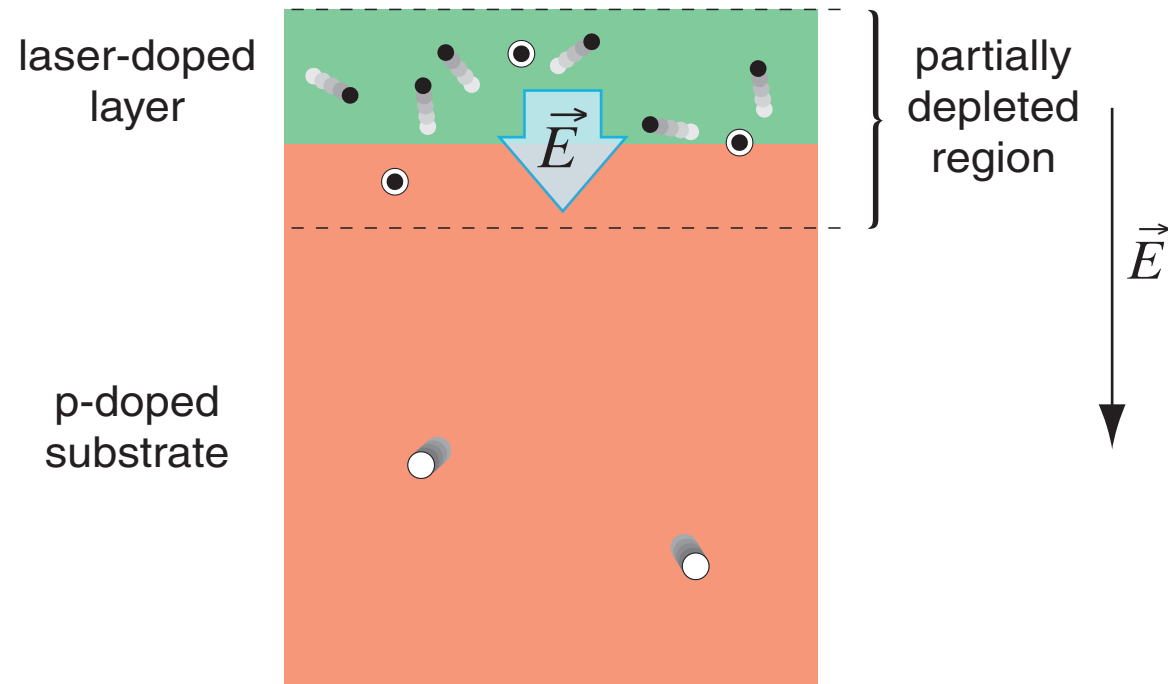

apply backward bias...

Devices

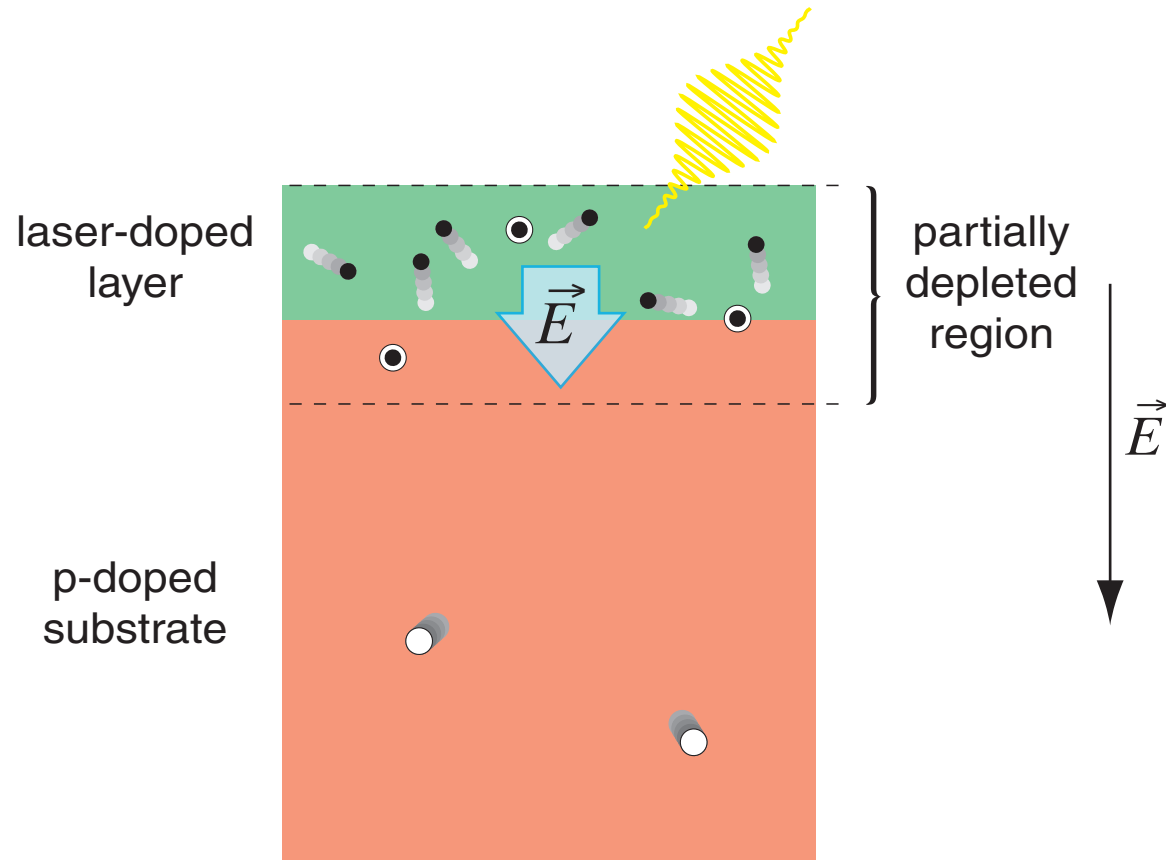

...incident photon generates electron-hole pair...

Devices

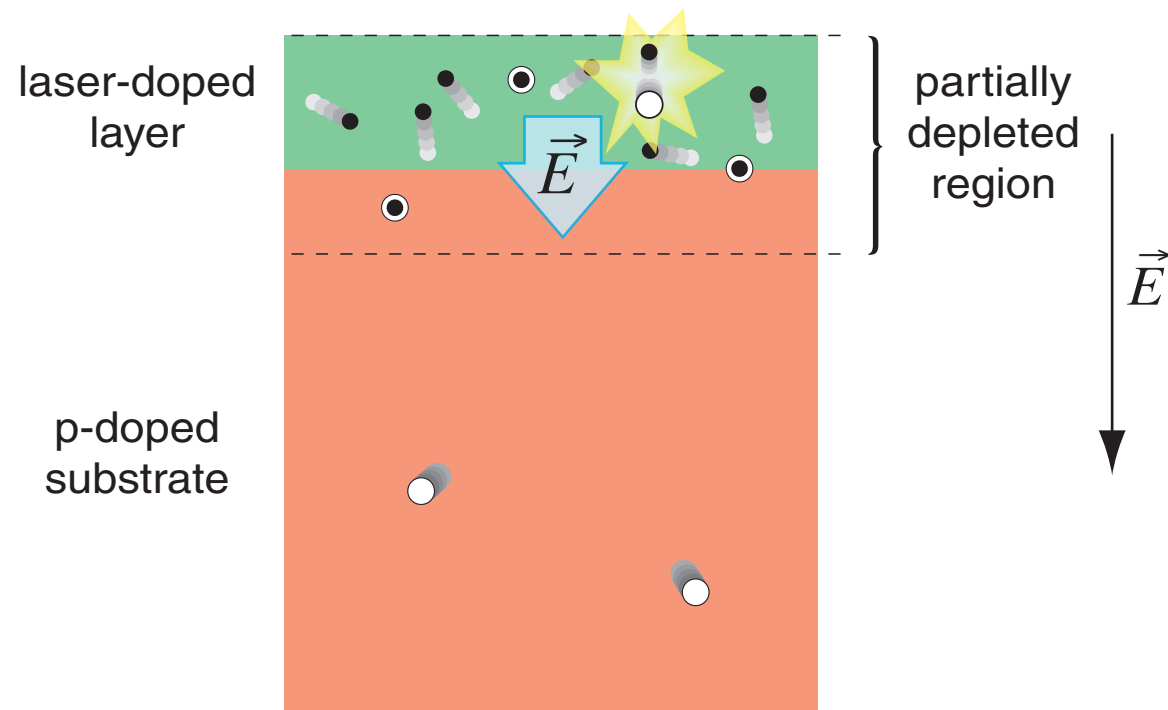

...incident photon generates electron-hole pair...

Devices

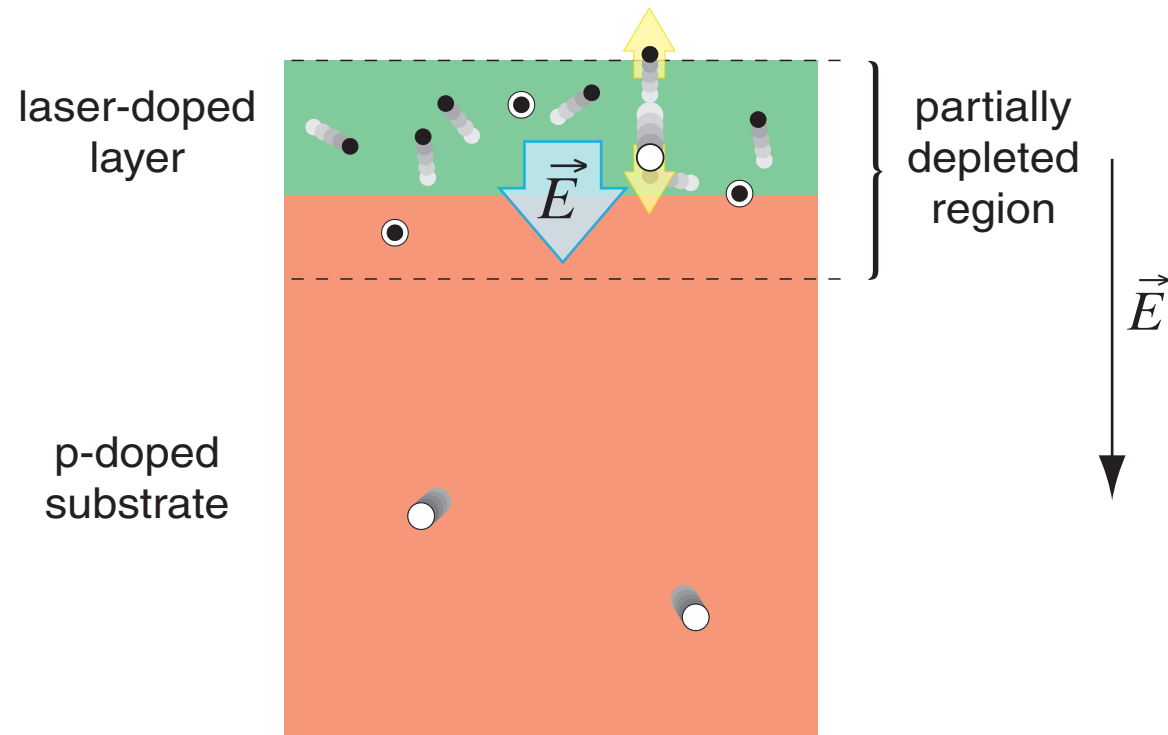

...carriers accelerate away from each other...

Devices

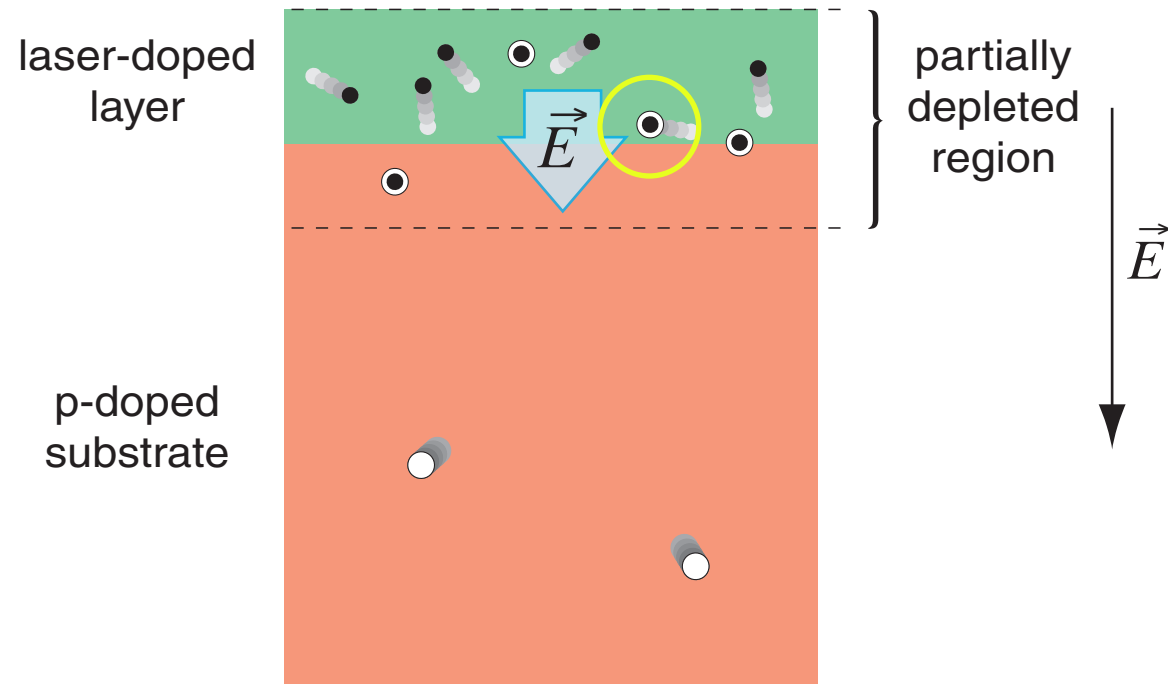

...hole is trapped

Devices

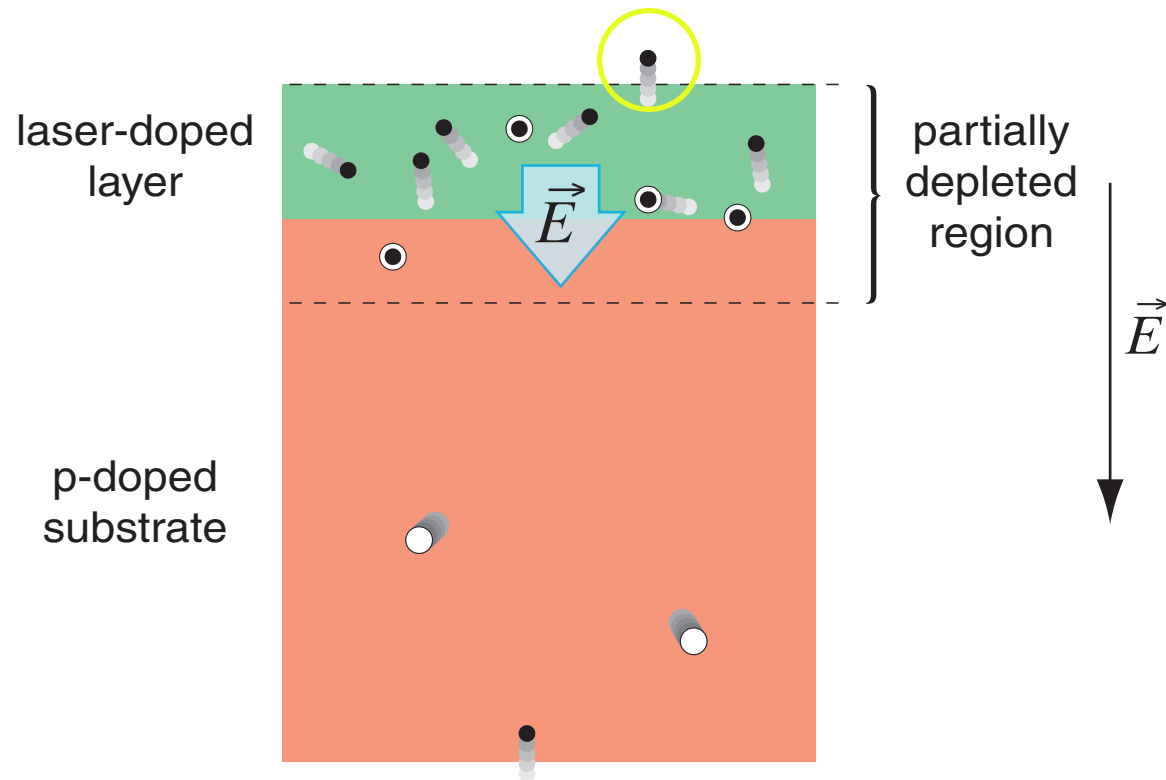

meanwhile electron exits sample...

Devices

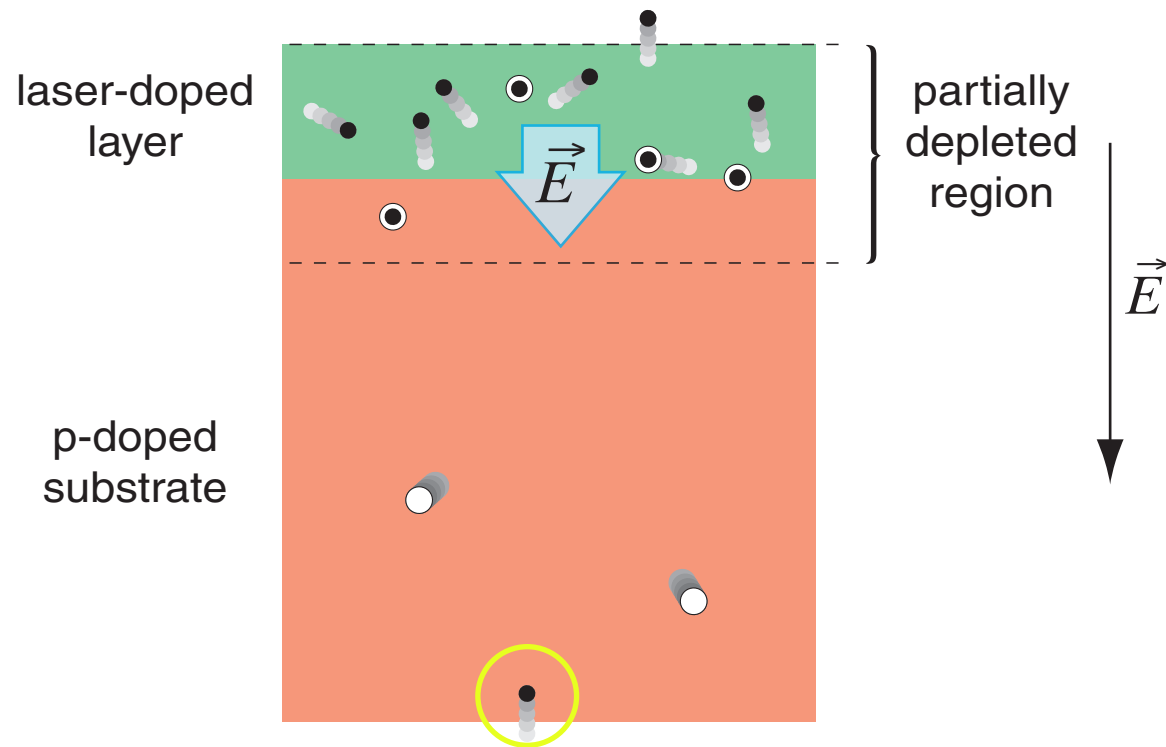

...and source provides new electron

Devices

Things to keep in mind

- can turn absorption into carrier generation
- very high responsivity in VIS and IR
- phenomenal photoconductive gain

Devices

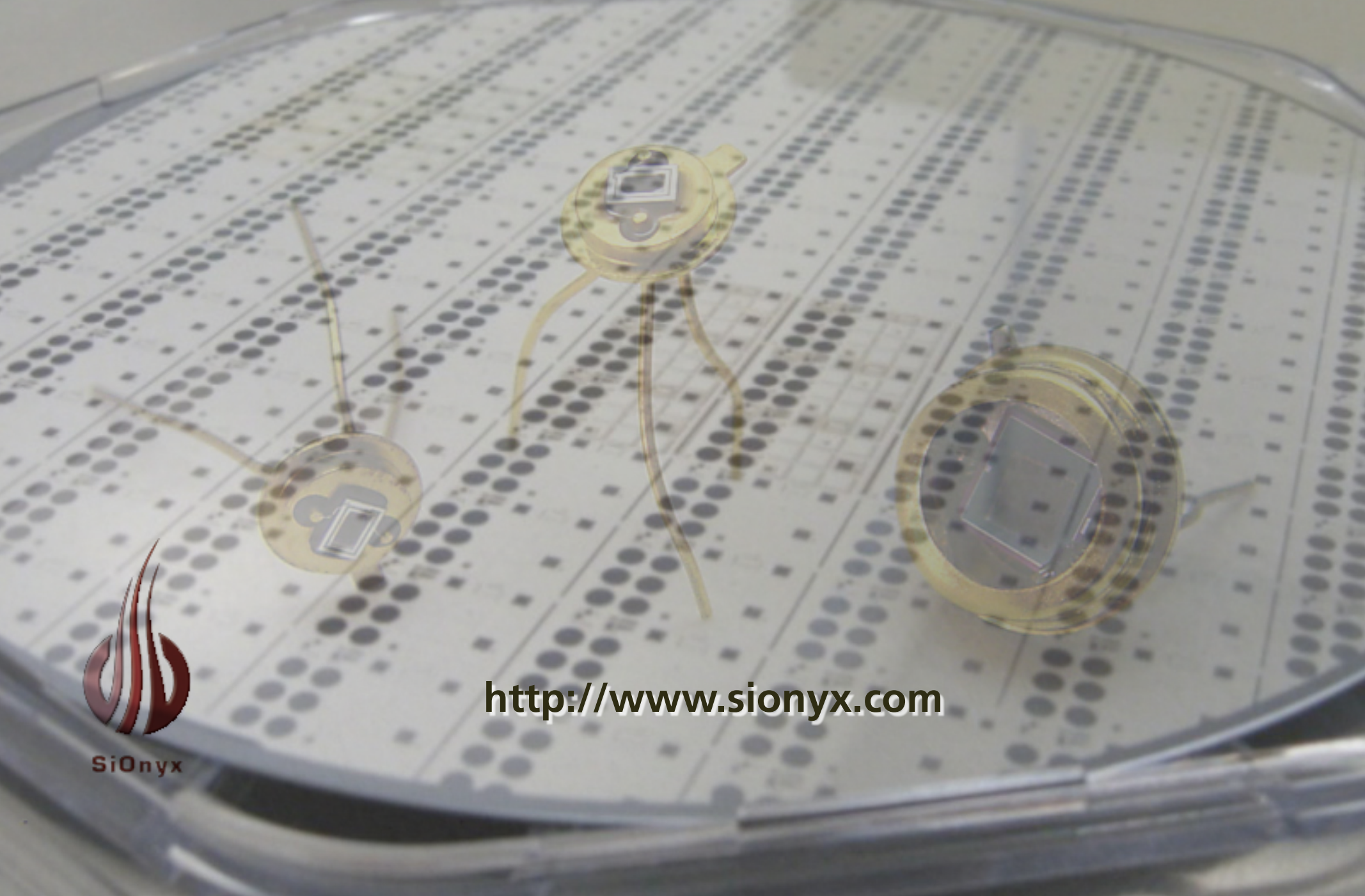

SiOnyx

<http://www.sionyx.com>

Devices

Potential benefits for photovoltaics

- surface structure
- absorption in submicrometer layer
- extended IR absorption
- intermediate band

Conclusion

- **new doping process**
- **new class of material**
- **new types of (silicon-based) devices**

Conclusion

What is different about this process?

A collection of colorful, star-patterned paper scraps is scattered on a white surface. The scraps are in various shades of blue, purple, and cyan, with some featuring small white stars. The scraps are of different sizes and are partially overlapping each other. The background is a plain, light-colored surface.

Conclusion

Compare femtosecond laser doping to:

- **inclusion during growth**
- **thermal diffusion**
- **ion implantation**



Funding:

Army Research Office

DARPA

Department of Energy

NDSEG

National Science Foundation

for more information and a copy of this presentation:

<http://mazur-www.harvard.edu>

Follow me!



eric_mazur

Google™

Google Search

I'm Feeling Lucky

Google™

mazur

Google Search

I'm Feeling Lucky

Google™

Google Search

I'm Feeling Lucky

Google™

Google Search

I'm Feeling Lucky

Funding:

Army Research Office

DARPA

Department of Energy

NDSEG

National Science Foundation

for more information and a copy of this presentation:

<http://mazur-www.harvard.edu>

Follow me!



eric_mazur

Devices

solar spectrum

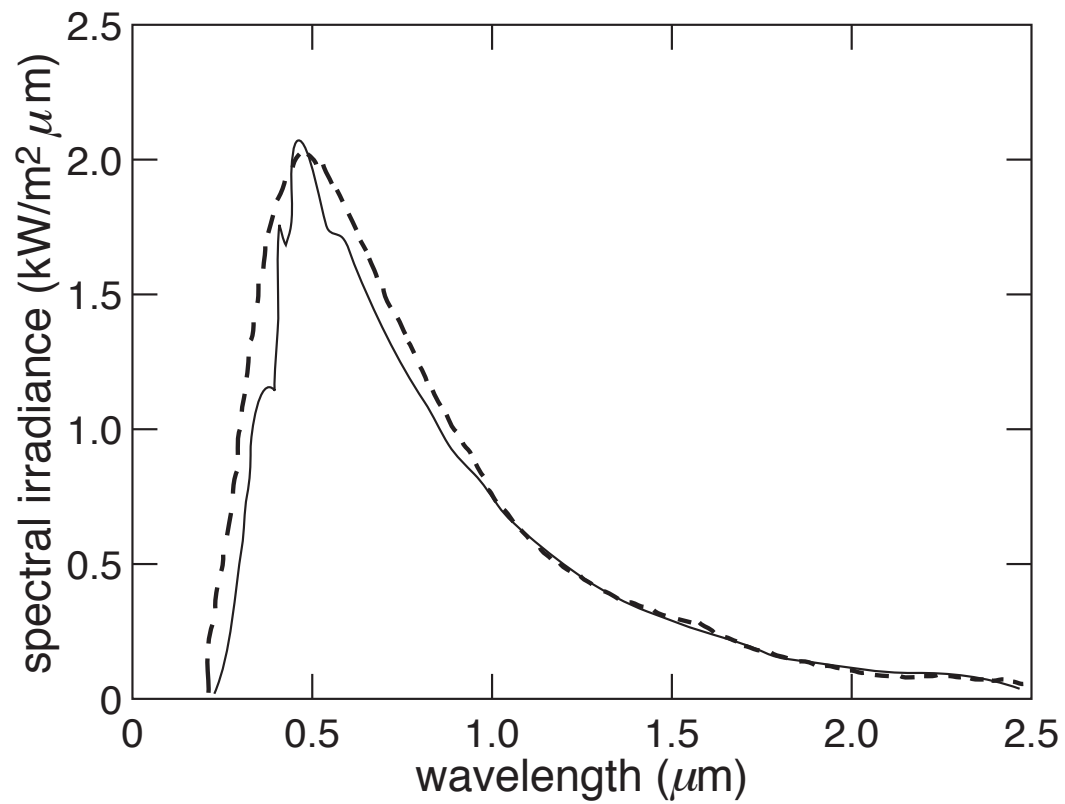

Devices

solar spectrum

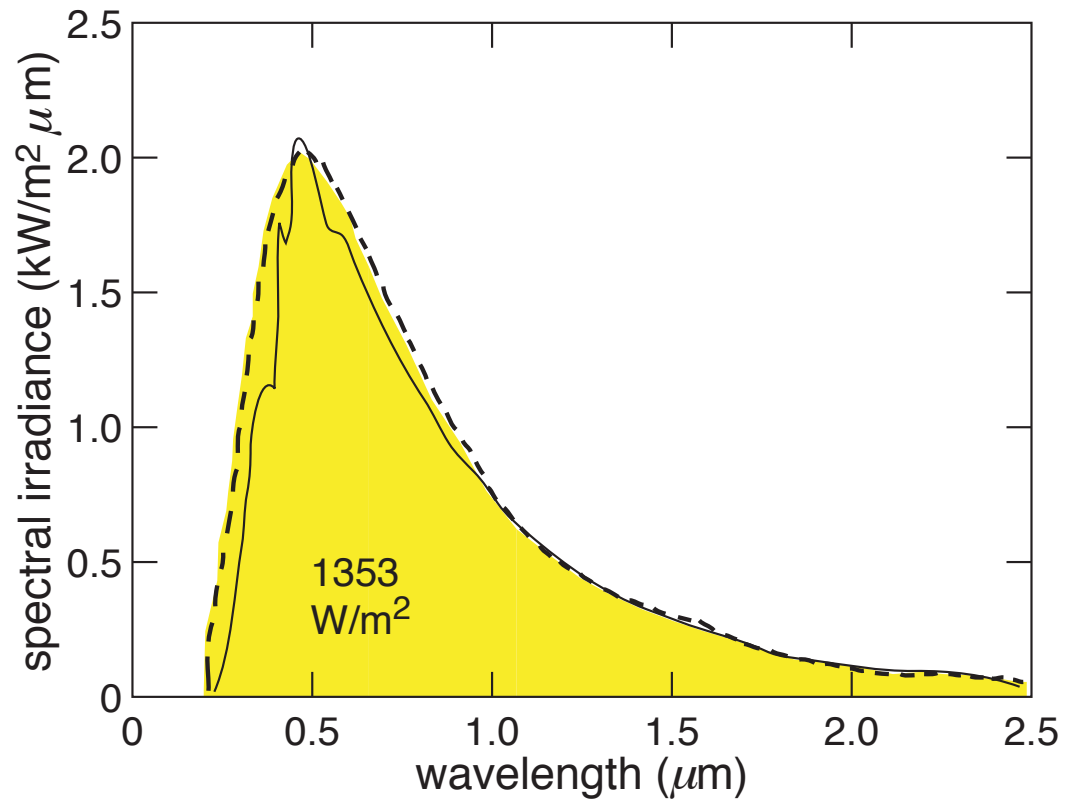

Devices

crystalline silicon: transparent to 23% of solar radiation

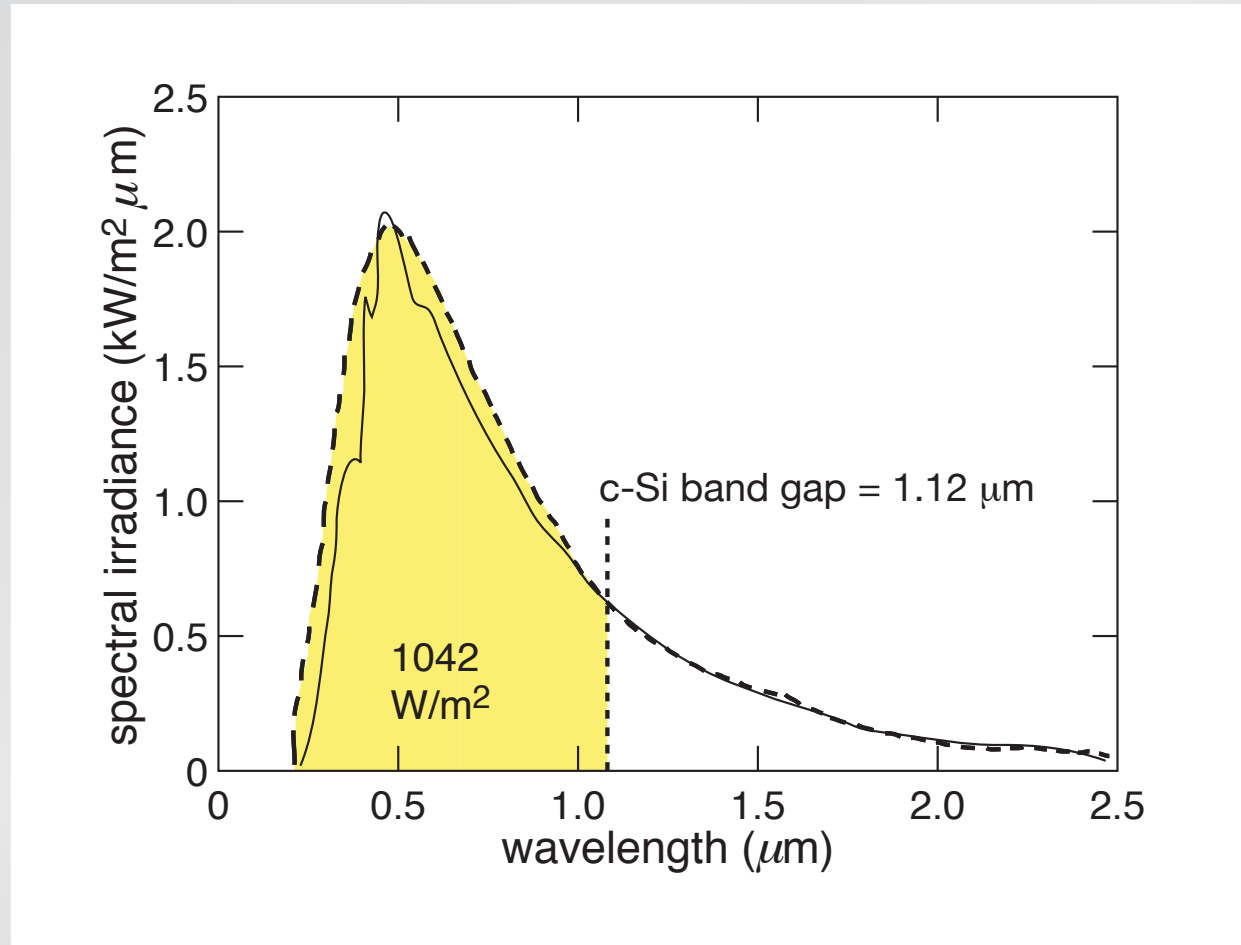

Devices

amorphous silicon: transparent to 53% of solar radiation

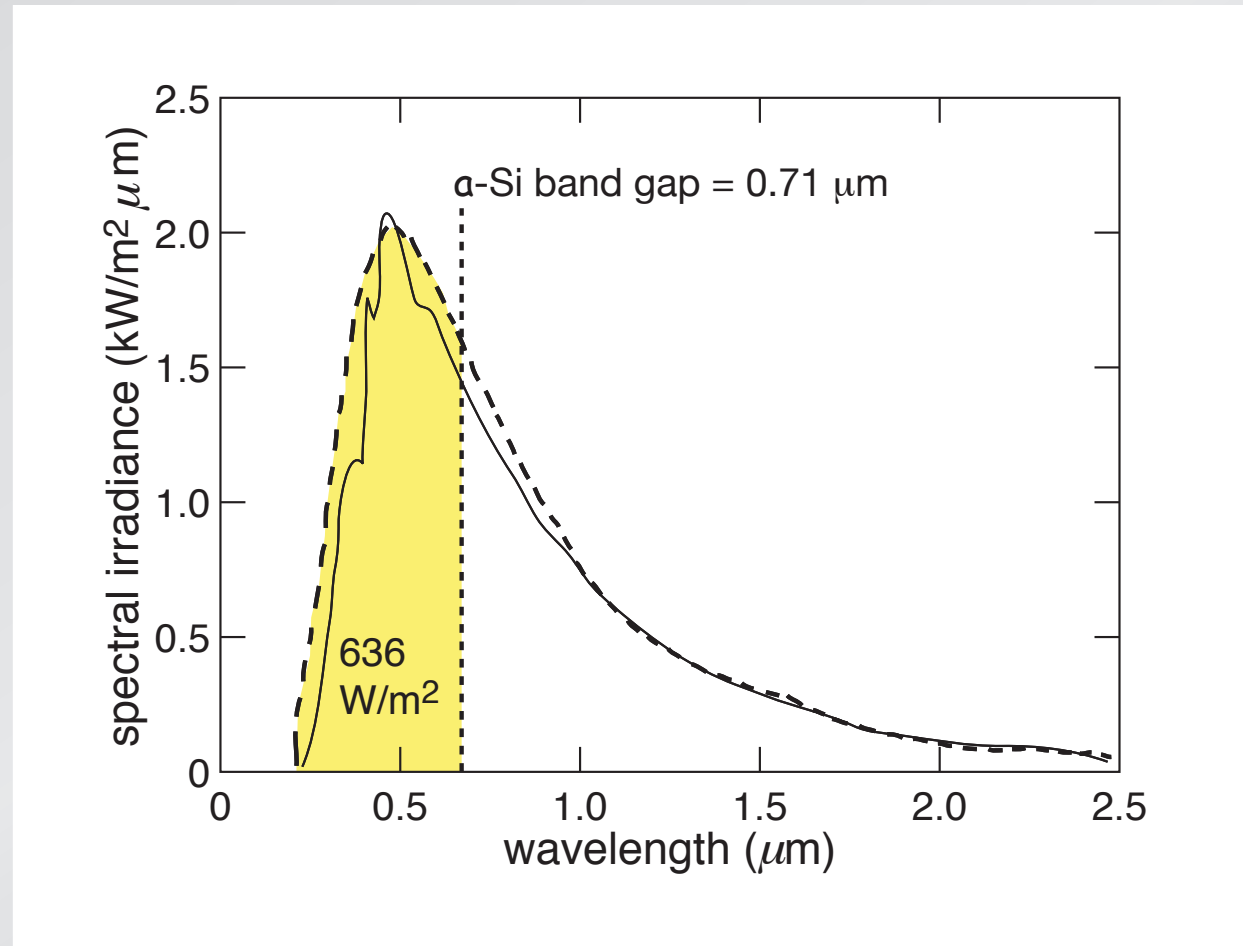

Devices

black silicon: potential to recover transmitted energy

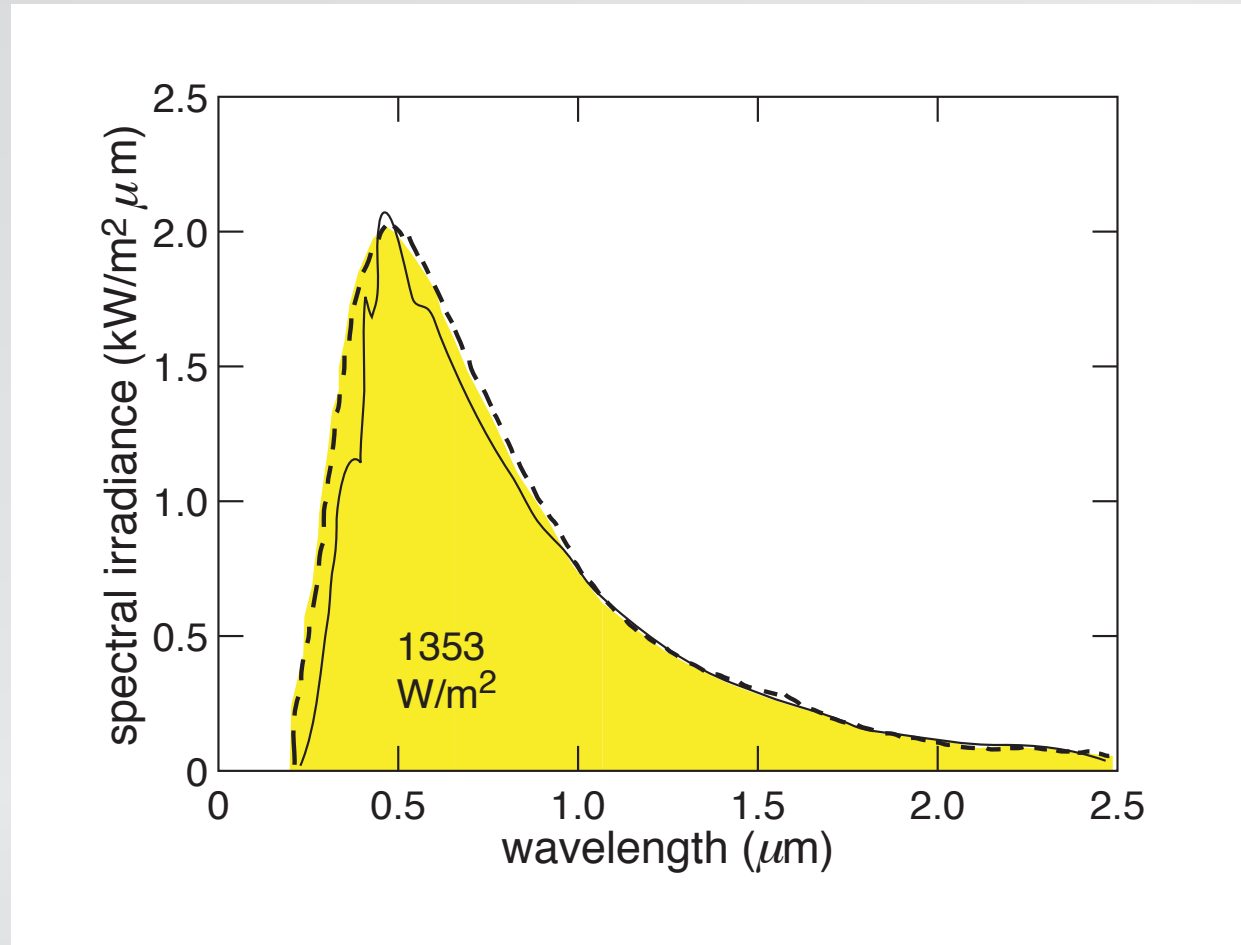

Devices

very preliminary photovoltaic cell

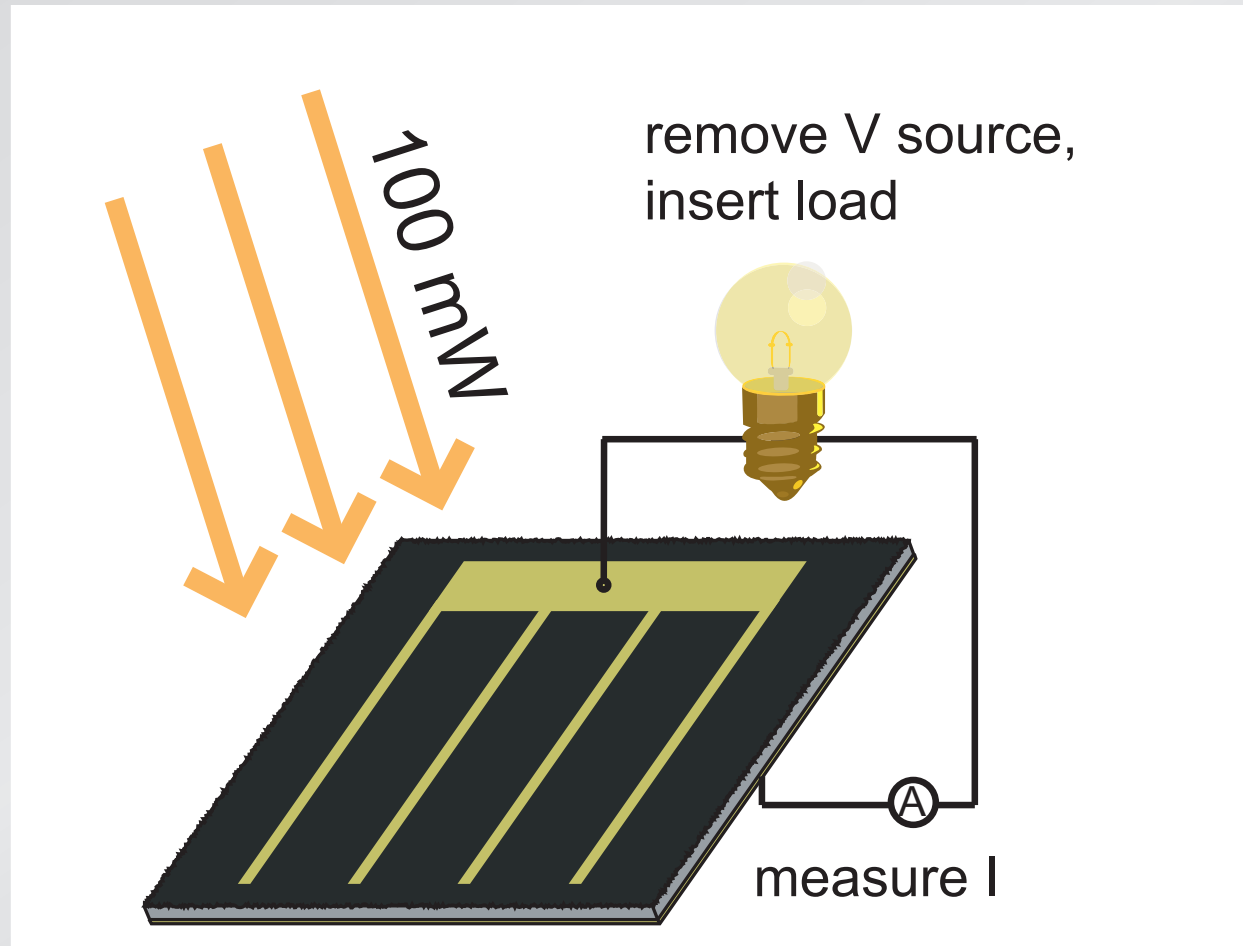

Devices

very preliminary photovoltaic cell

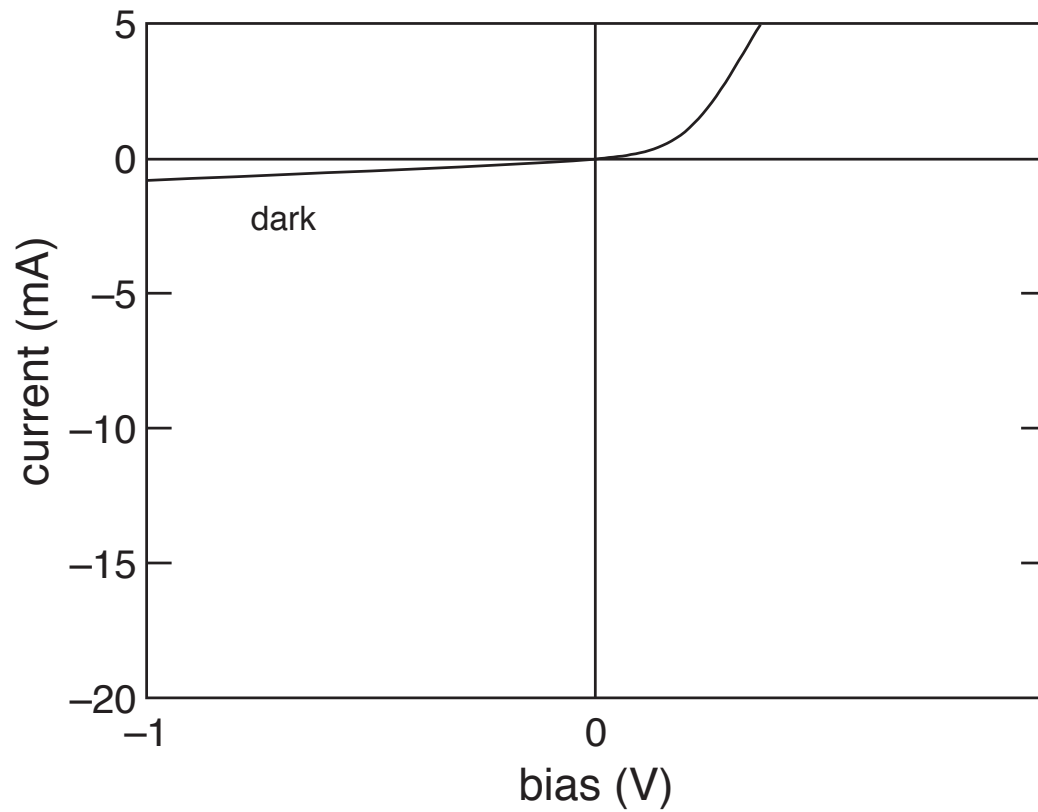

Devices

very preliminary photovoltaic cell

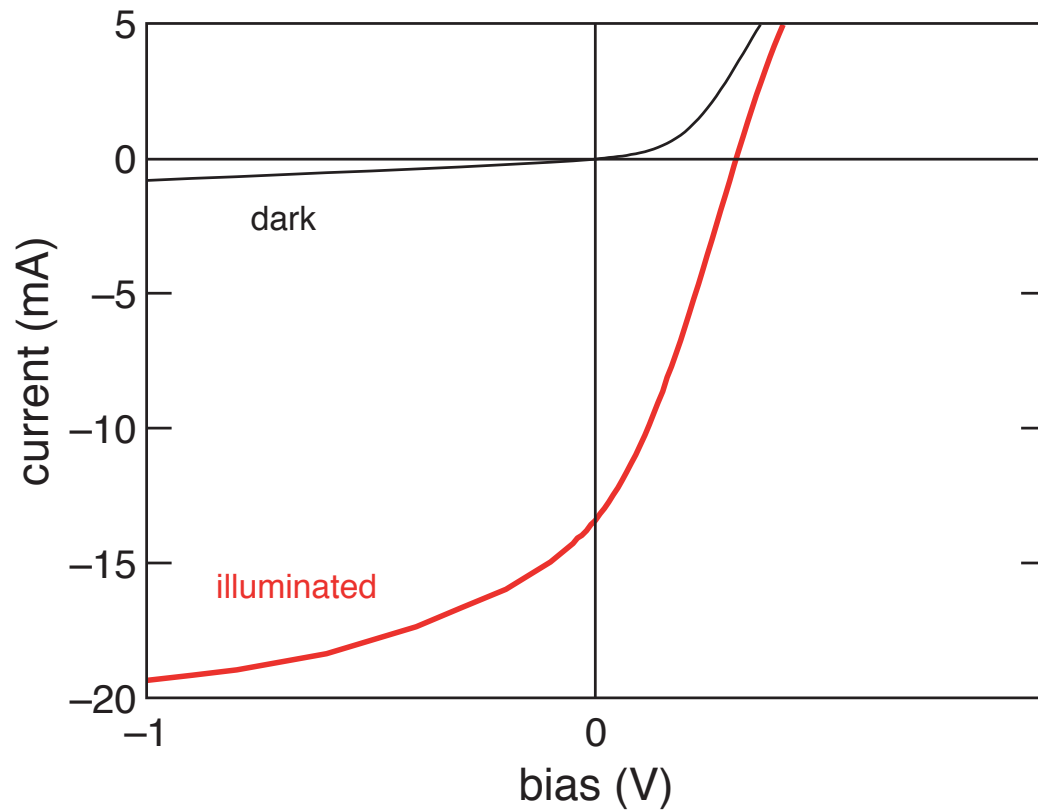

Devices

1.5% efficiency, a good beginning

