

Memorization or understanding: are we teaching the right thing?



Ewha Womans University
Seoul, South Korea, 10 January 2012



한국어를 하지 않아 미안합니다.

(공부 중입니다.)

Memorization or understanding: are we teaching the right thing?

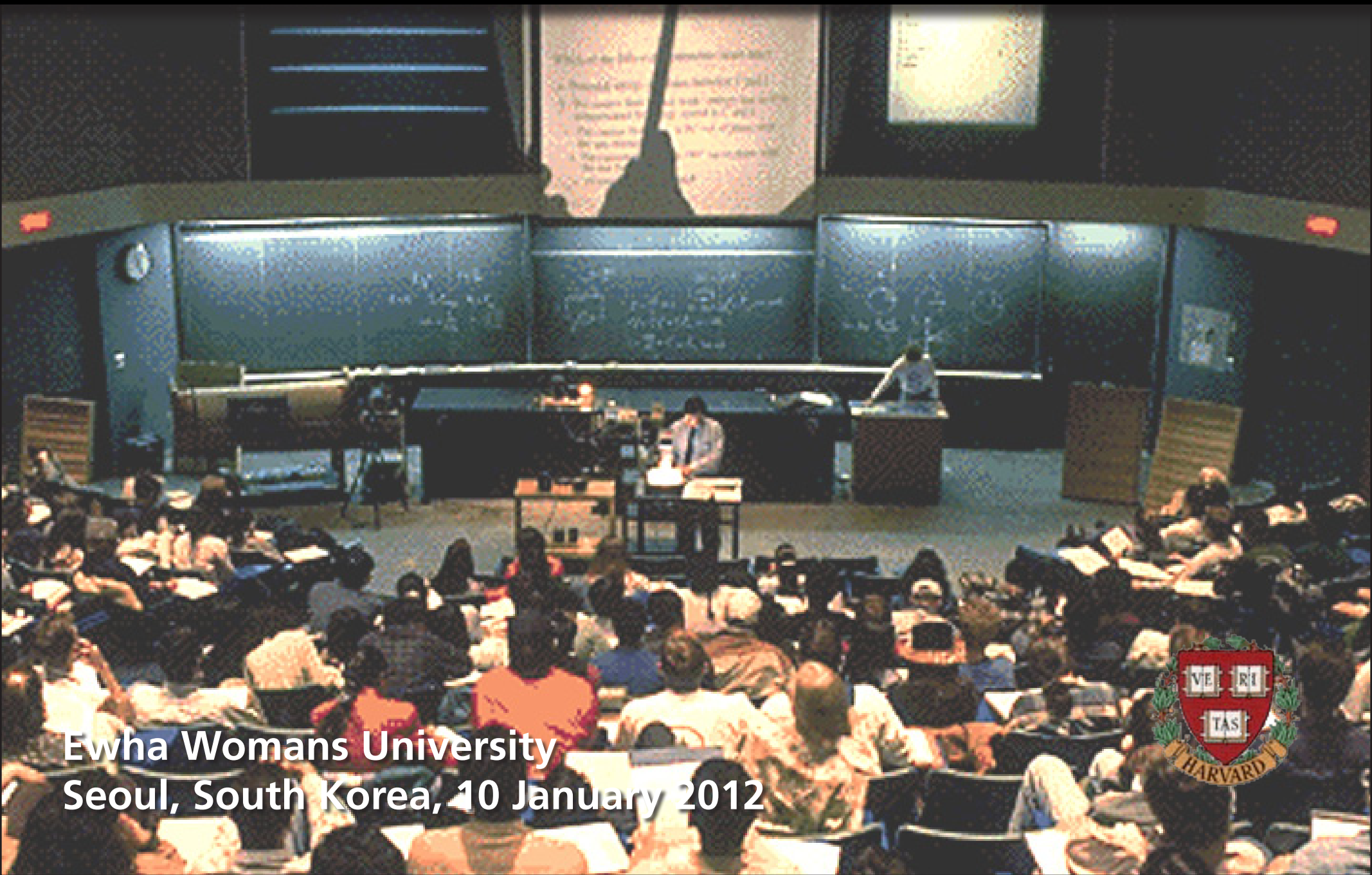

Ewha Womans University
Seoul, South Korea, 10 January 2012



Get your clickers ready!

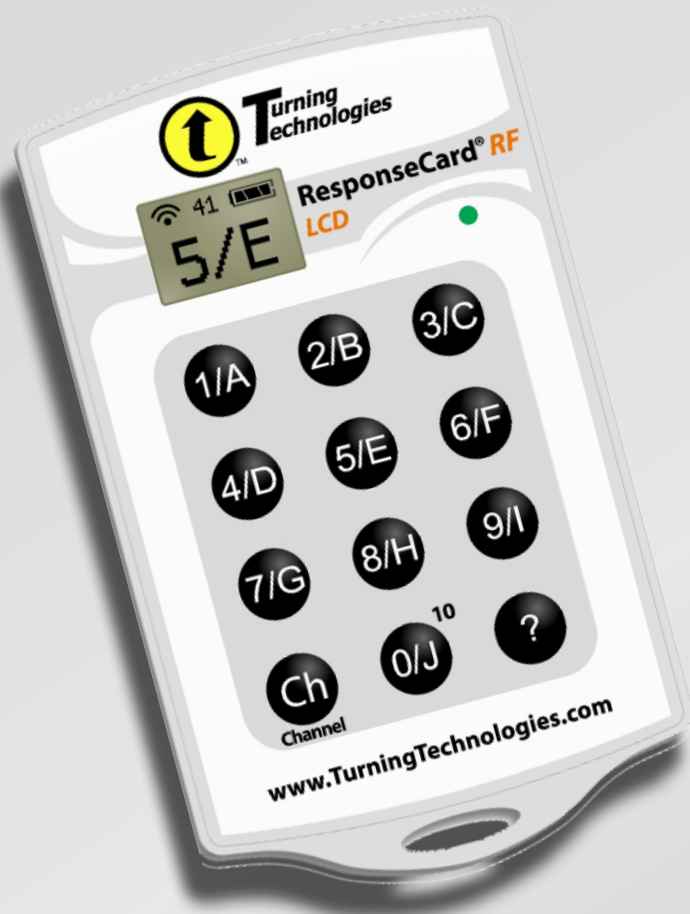

- no ON/OFF button
- only last “click” counts
- display shows recorded answer

Get your clickers ready!

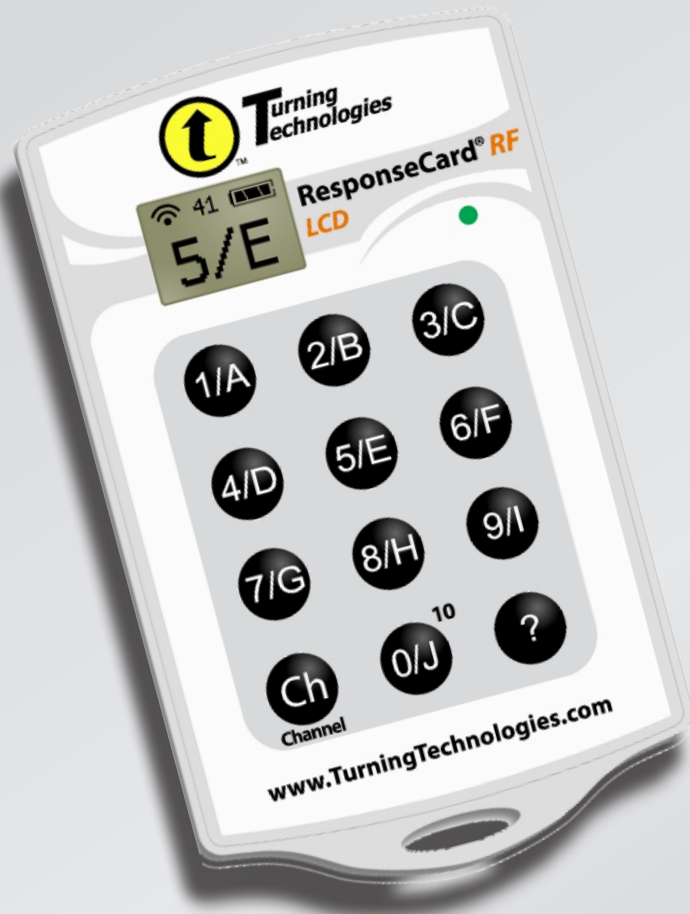

Or use your web-enabled device!

- go to <http://rwpoll.com>
- enter session ID: **EMAZUR**

rwpoll.com

Get your clickers ready!



www.TurningTechnologies.com

Get your clickers ready!



unique ID on back of clicker

Quick survey...

Peer Instruction...

1. Never heard of it.
2. I watched a video of your presentation online.
3. I heard someone else present on Peer Instruction.
4. I've attended one of your talks on Peer Instruction before.
5. I heard you speak about it so often, I could give your talk!



Quick survey...

Peer Instruction...

1. Never heard of it.
2. Don't use it in my classes, but I'm open to it.
3. Considering using it in my classes.
4. I have used it in my classes a few times.
5. I use it regularly in my classes.



How do we learn?

Think of something you are good at — something that you know you do well.

How do we learn?

Think of something you are good at — something that you know you do well.

How did you become good at this?

How do we learn?

Became good at it by:

1. trial and error
2. lectures
3. practicing
4. apprenticeship
5. other



How we teach...



Learning spaces



Learning spaces



Learning spaces



Education



Education

Some people talk in their sleep.

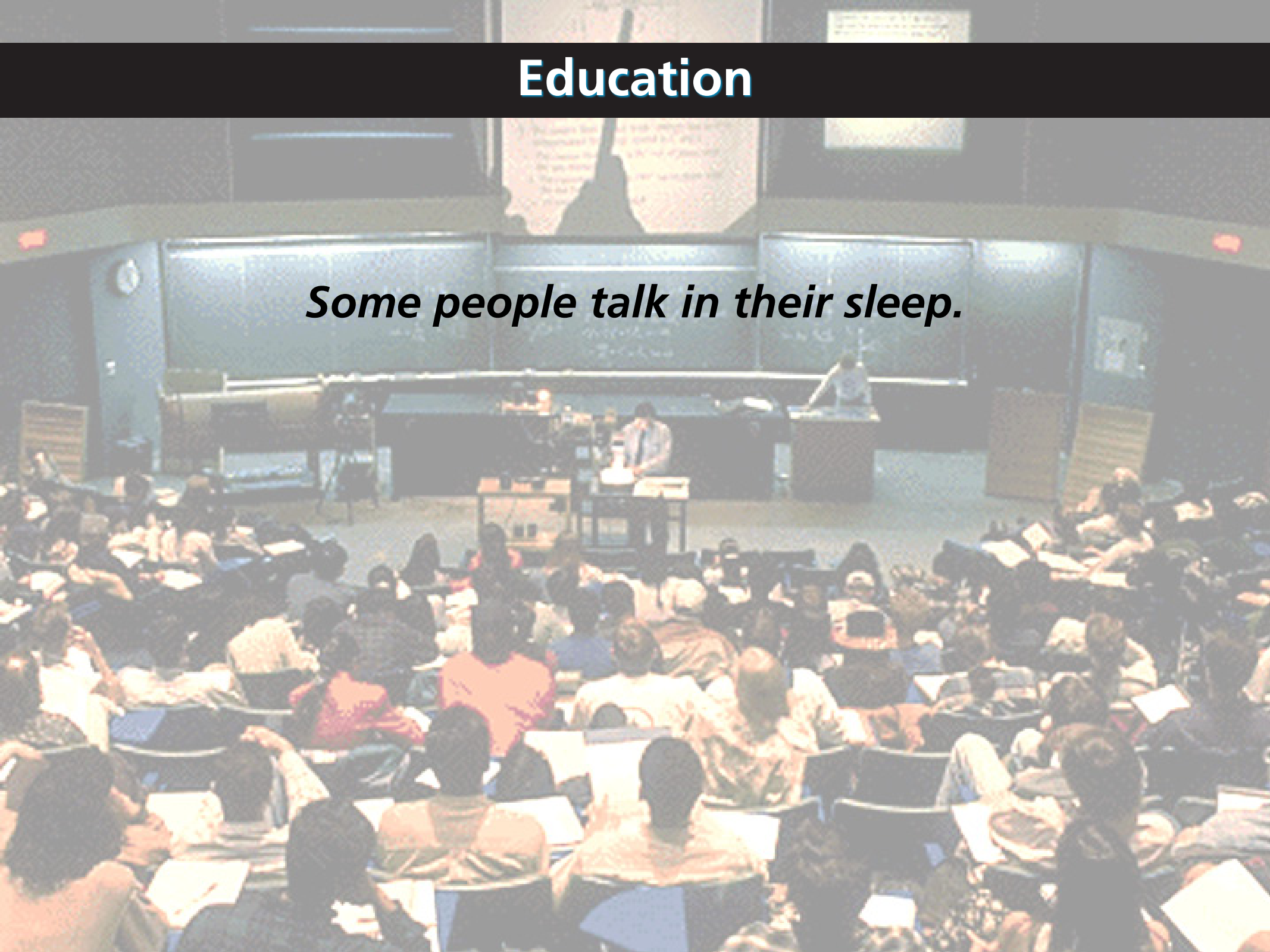

Education

A large lecture hall with a lecturer at the front and many students in the audience. The room is filled with people, and the lecturer is standing at a podium, addressing the class. The students are seated in rows, and many are looking towards the front. The room has a high ceiling and large windows.

Some people talk in their sleep.

Lecturers talk while other people are sleeping.

Albert Camus

Education



Education

lectures focus on information transfer...

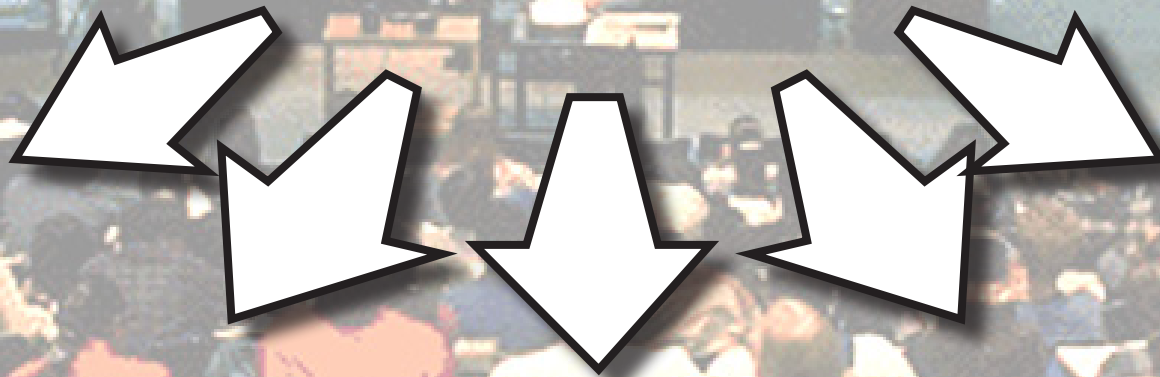

Education

education is not just information transfer

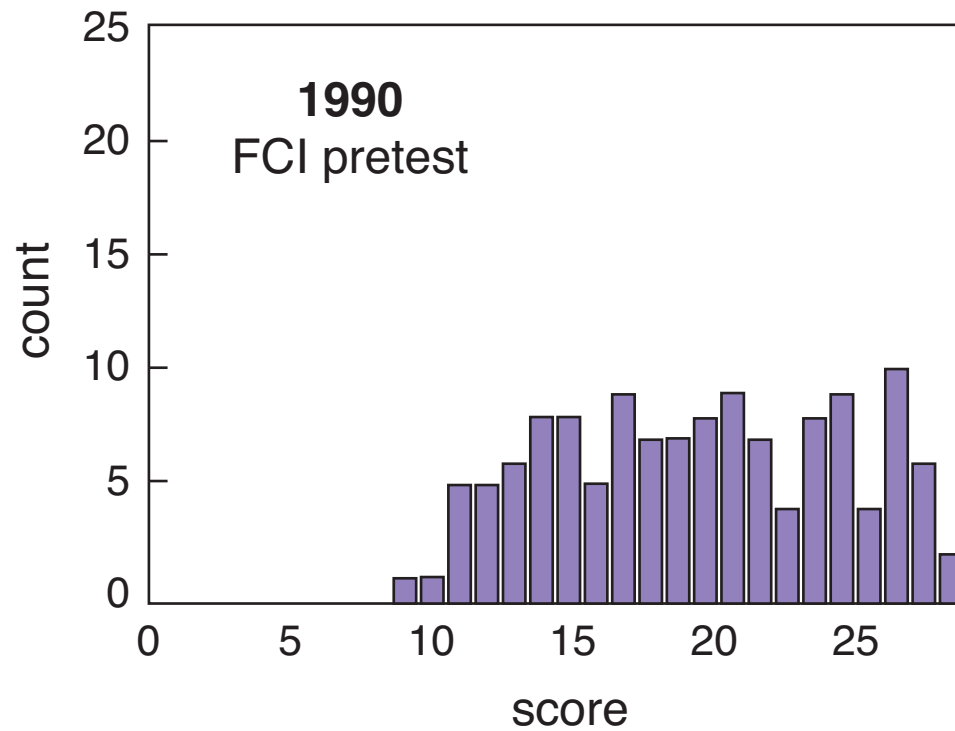

Education

education is not just information transfer

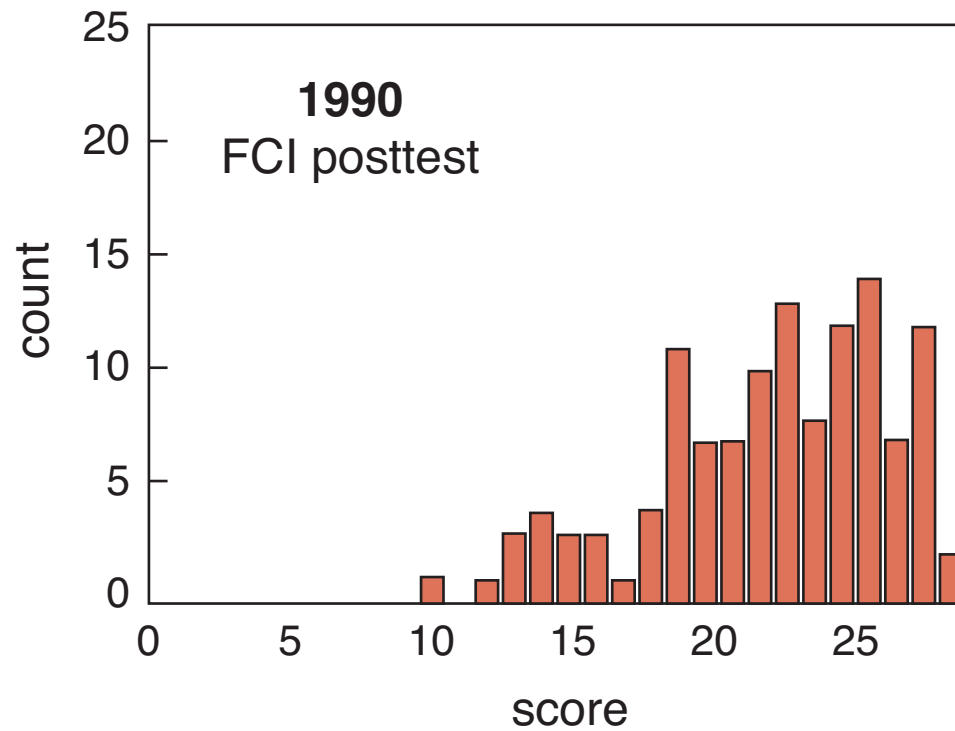

Education

education is not just information transfer

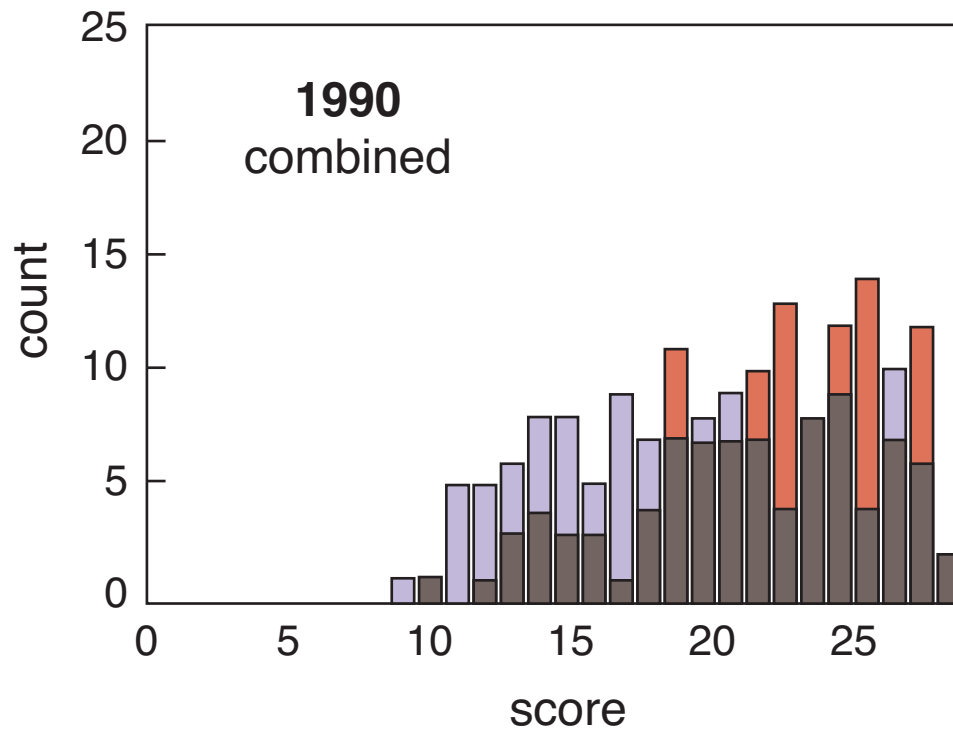

Education

conventional problems misleading

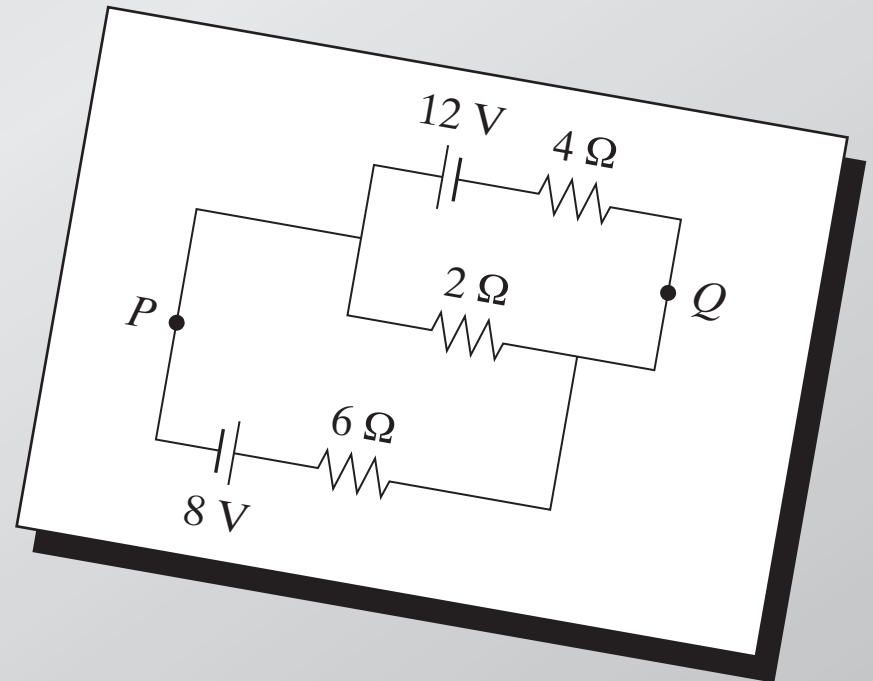

Education

conventional problems misleading

Calculate:

(a) current in $2\text{-}\Omega$ resistor

(b) potential difference

between P and Q

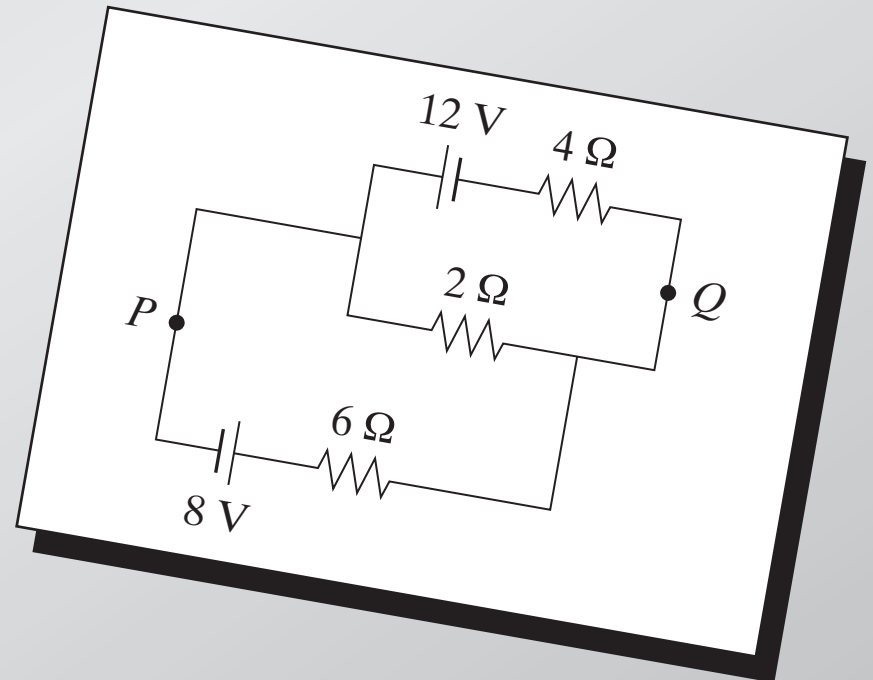

Education

are the basic principles understood?

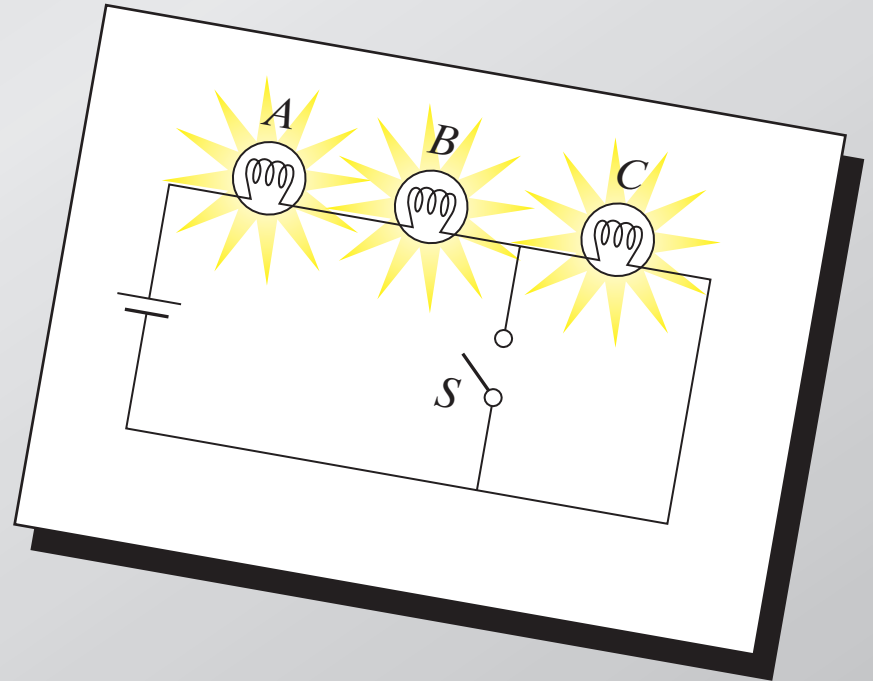

Education

are the basic principles understood?

When S is closed, what happens to:

- (a) intensities of A and B ?
- (b) intensity of C ?
- (c) current through battery?
- (d) potential difference across
 A , B , and C ?
- (e) the total power dissipated?

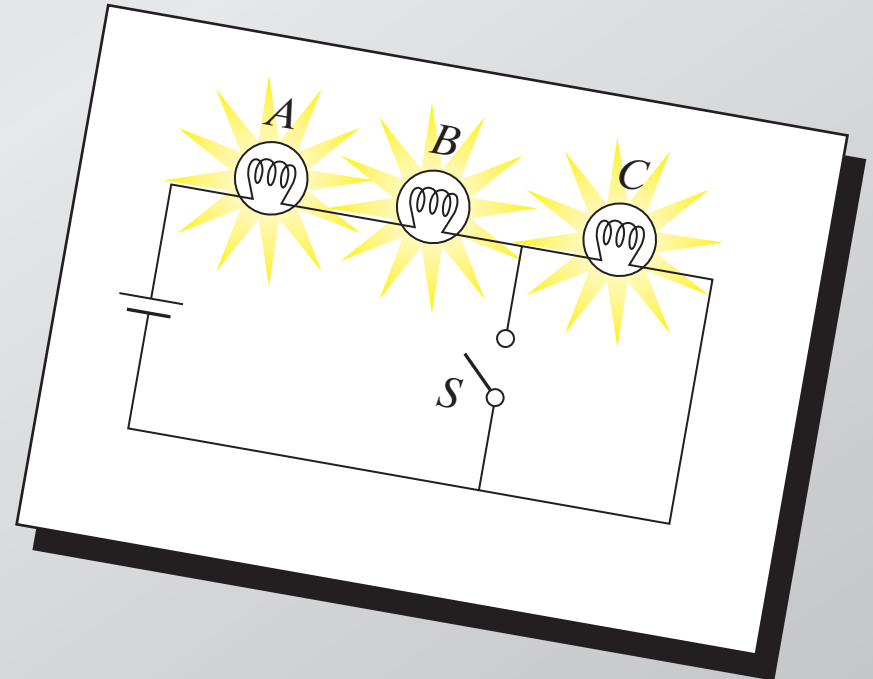

Education

conventional

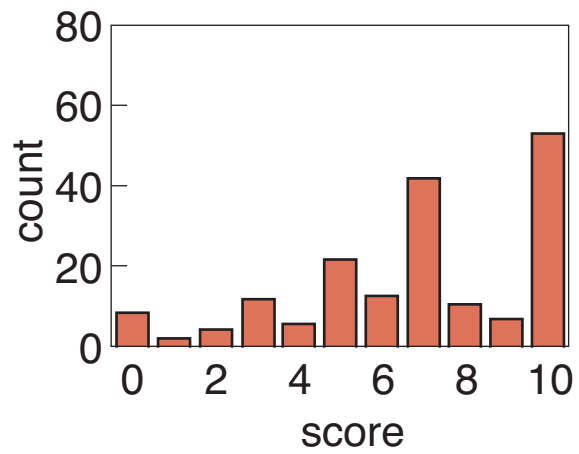

conceptual

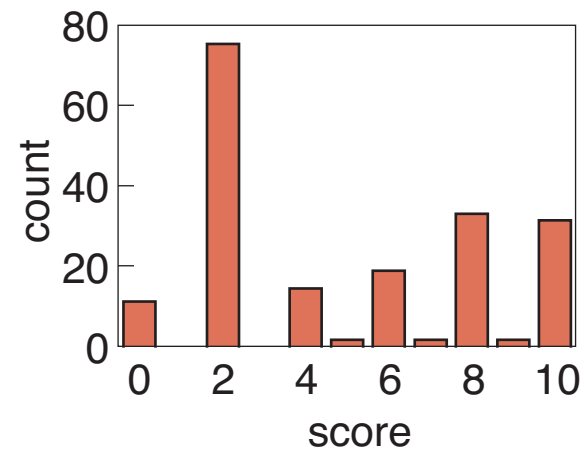

Education

conventional

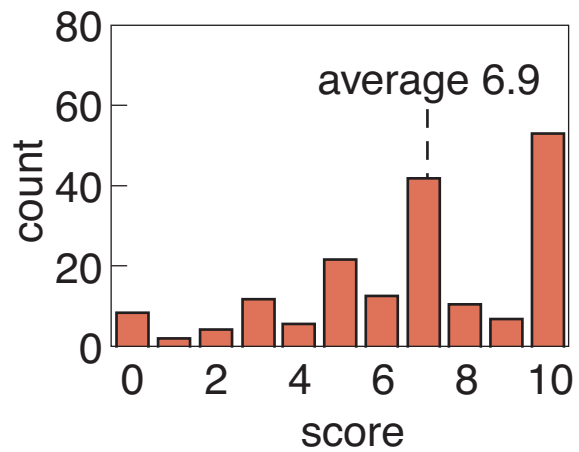

conceptual

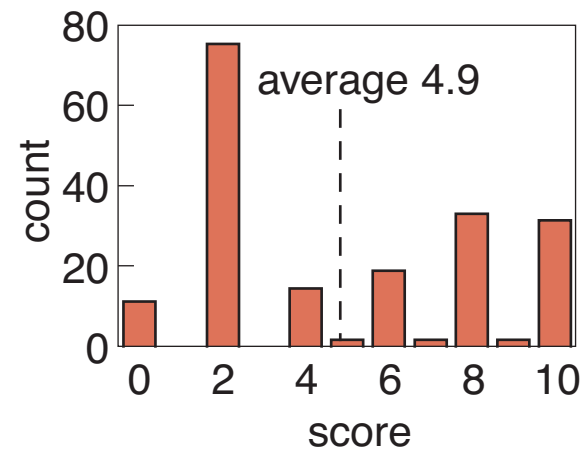

Education

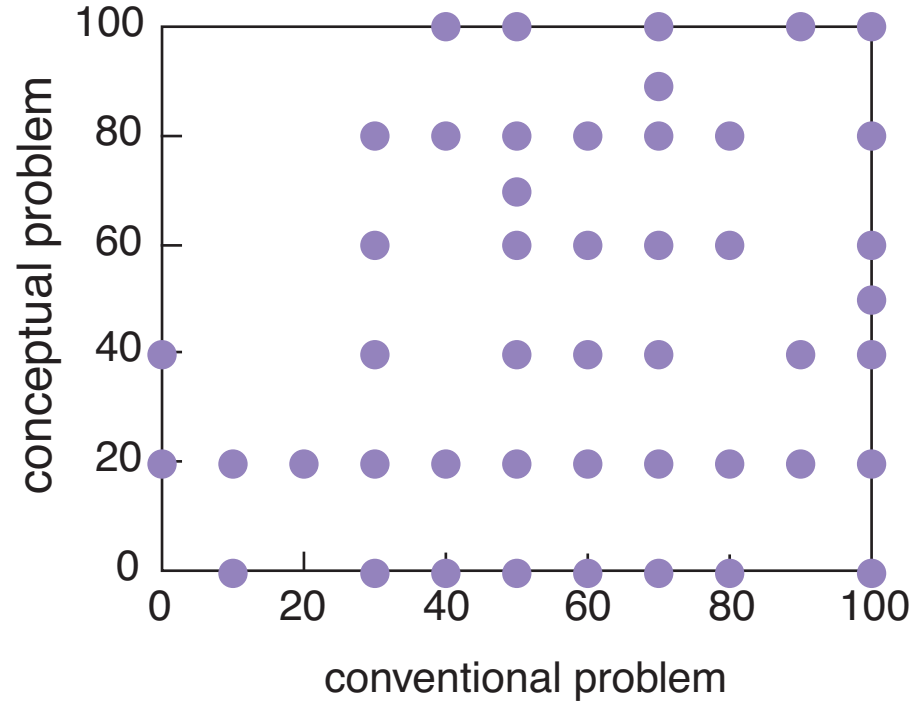

Education

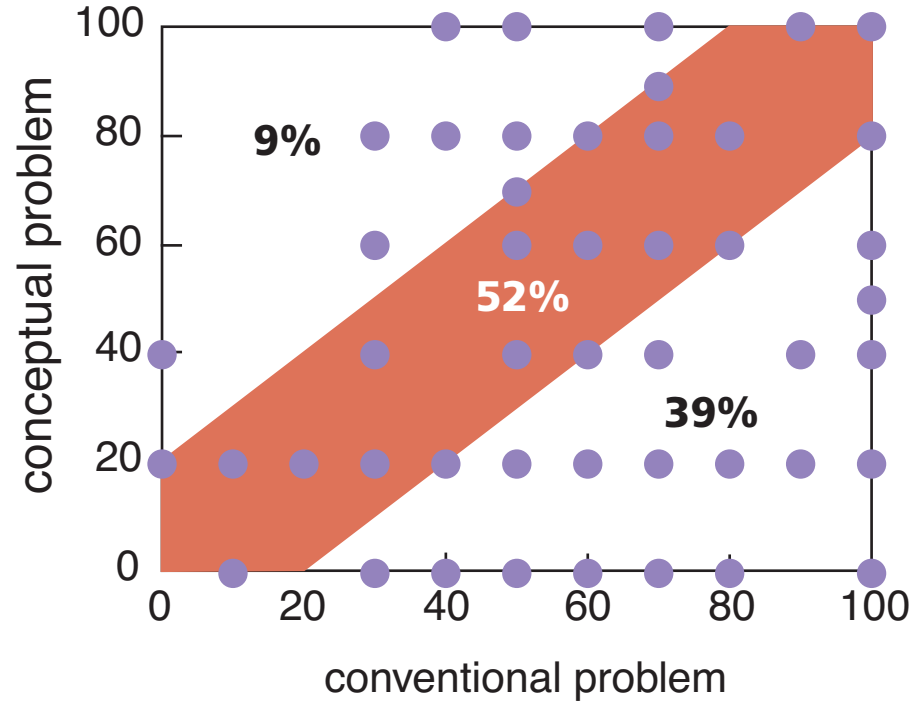



So what should we do?

Peer Instruction

Give students more responsibility for gathering information...

Peer Instruction

**Give students more responsibility for gathering information...
so we can better help them assimilate it.**

Peer Instruction

Main features:

- pre-class reading
- in-class: depth, not 'coverage'
- ConcepTests

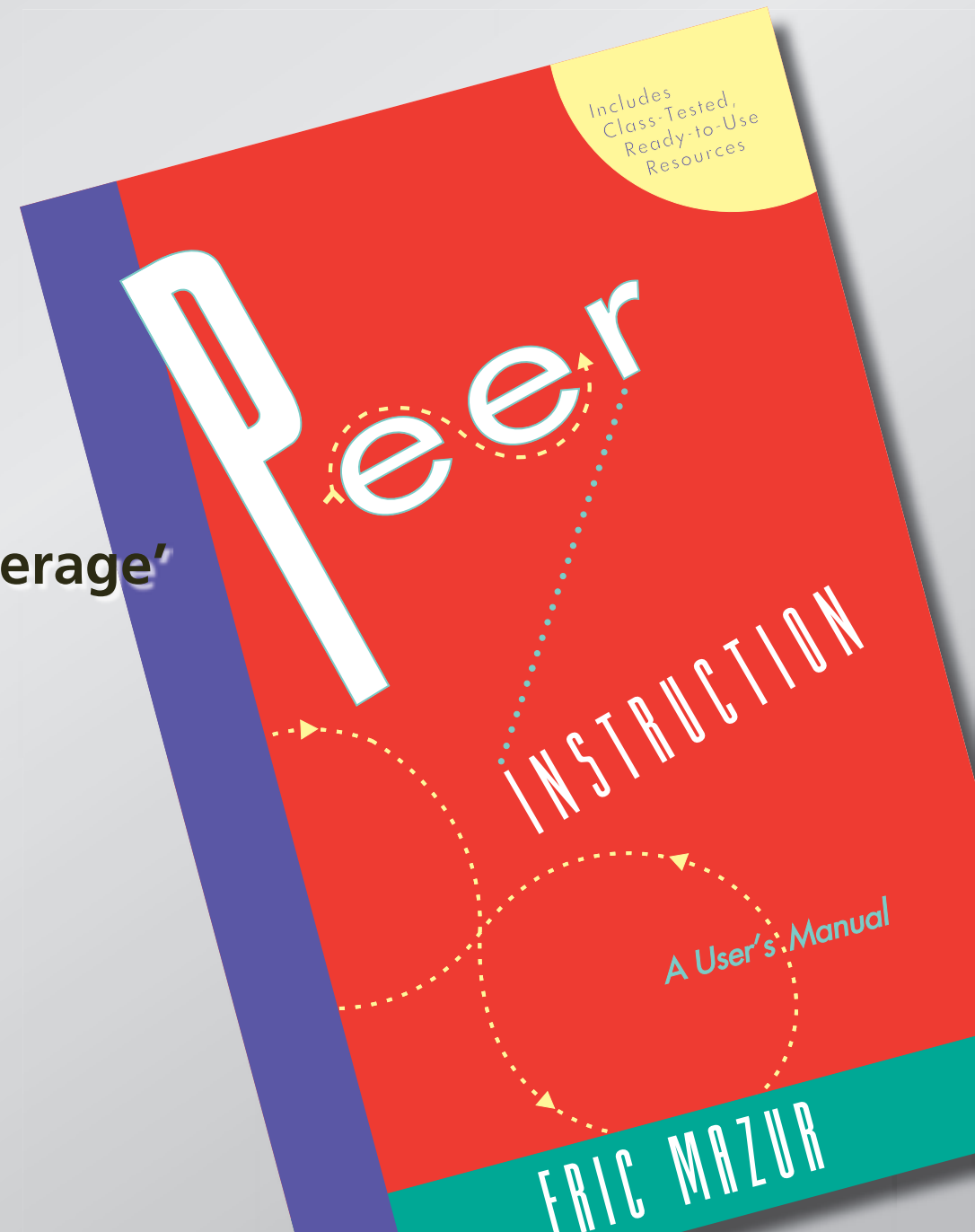

Peer Instruction

ConcepTest:

- 1. Question**
- 2. Thinking**
- 3. Individual answer**
- 4. Peer discussion**
- 5. Revised/Group answer**
- 6. Explanation**

Let's try it!

thermal expansion

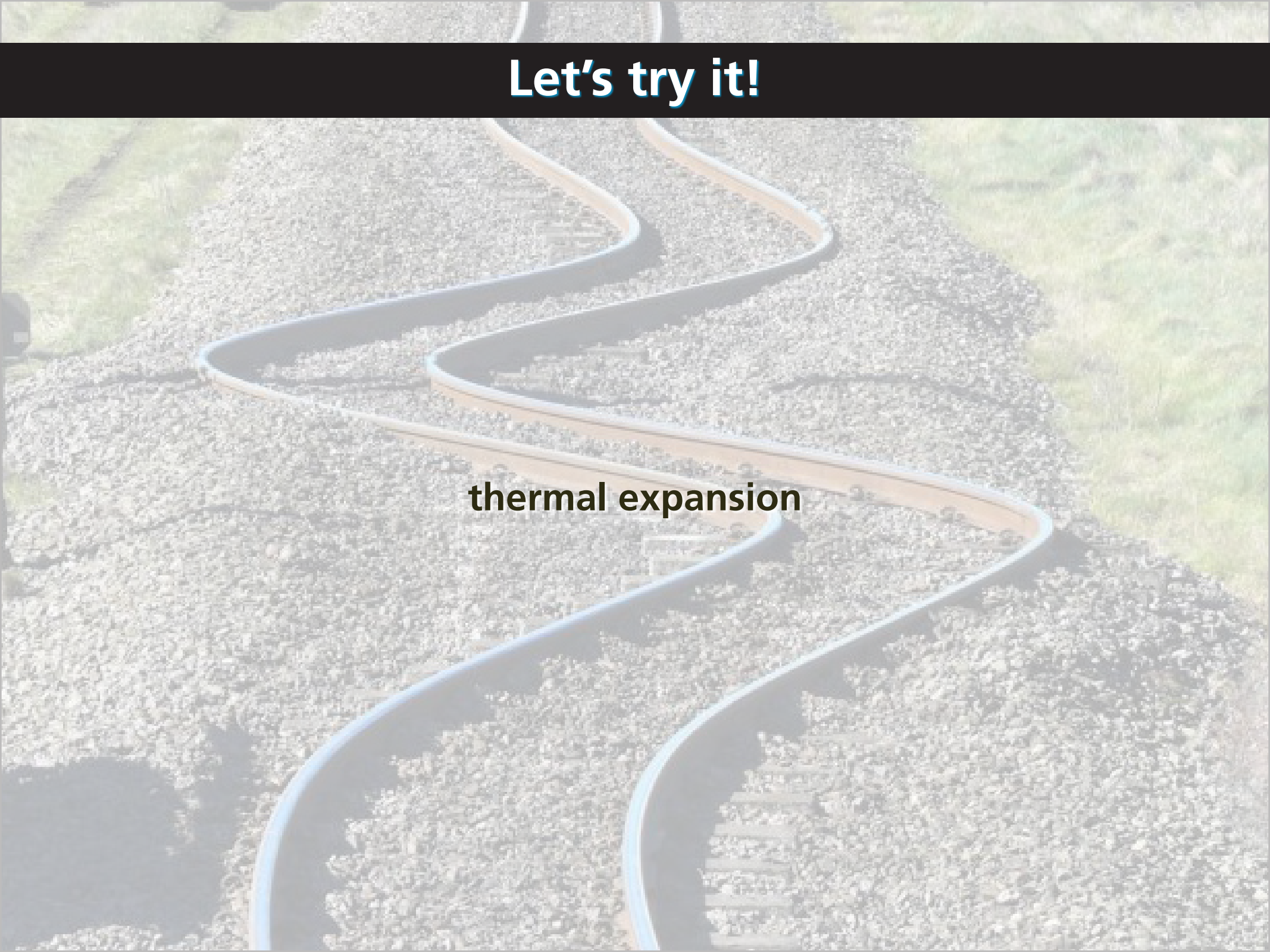

Let's try it!

When metals heat up, they expand because all atoms get farther away from each other.

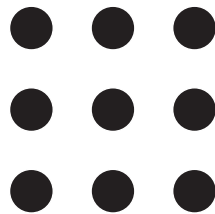

Let's try it!

When metals heat up, they expand because all atoms get farther away from each other.

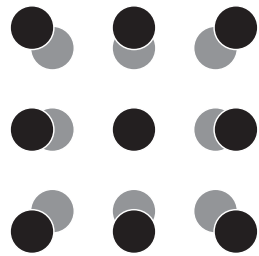

Let's try it!

When metals heat up, they expand because all atoms get farther away from each other.

all of them



Let's try it!

Consider a rectangular metal plate with a circular hole in it.

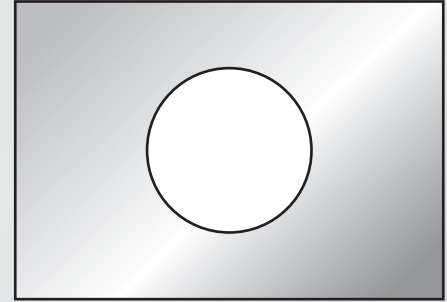

Let's try it!

Consider a rectangular metal plate with a circular hole in it.

When the plate is uniformly heated, the diameter of the hole

1. increases.
2. stays the same.
3. decreases.

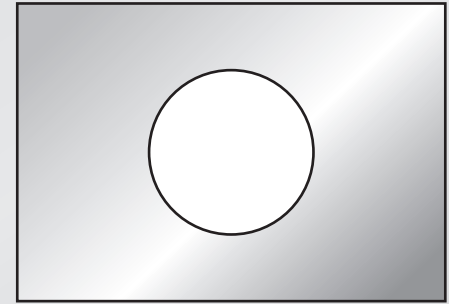

Let's try it!

Consider a rectangular metal plate with a circular hole in it.

When the plate is uniformly heated, the diameter of the hole

1. increases.
2. stays the same.
3. decreases.



you got all fired up!



Let's try it!

Consider a rectangular metal plate with a circular hole in it.

When the plate is uniformly heated, the diameter of the hole

1. increases.
2. stays the same.
3. decreases.

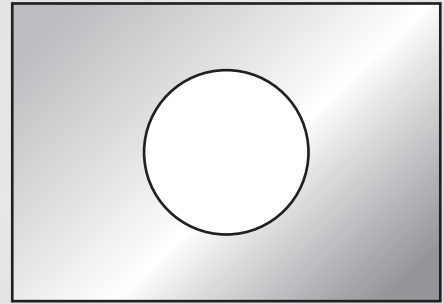

Let's try it!

Consider a rectangular metal plate with a circular hole in it.

When the plate is uniformly heated, the diameter of the hole

1. increases. ✓
2. stays the same.
3. decreases.

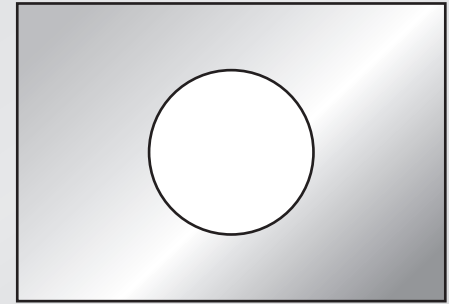

Let's try it!

consider the atoms at the rim of the hole

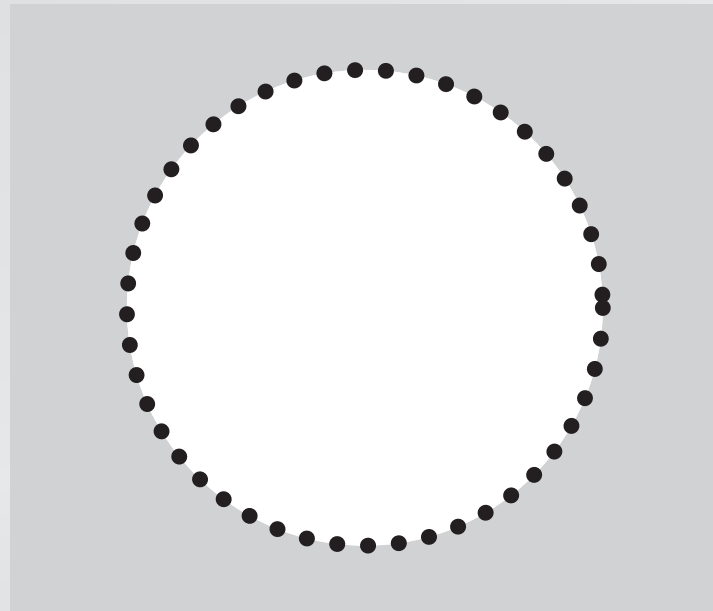

Let's try it!

consider the atoms at the rim of the hole

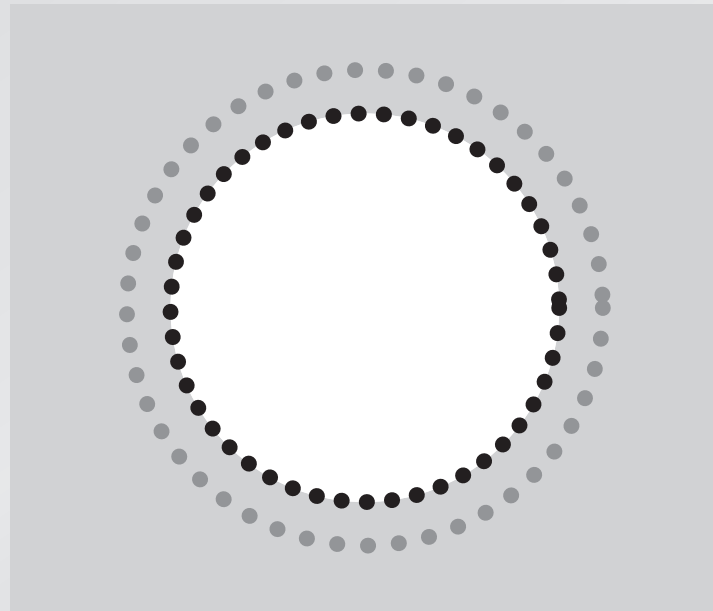

Let's try it!

consider the atoms at the rim of the hole

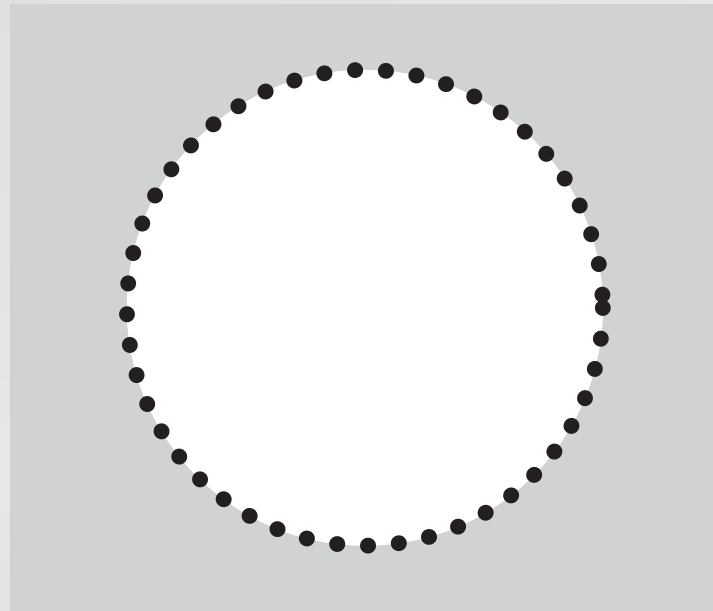

Let's try it!

consider the atoms at the rim of the hole

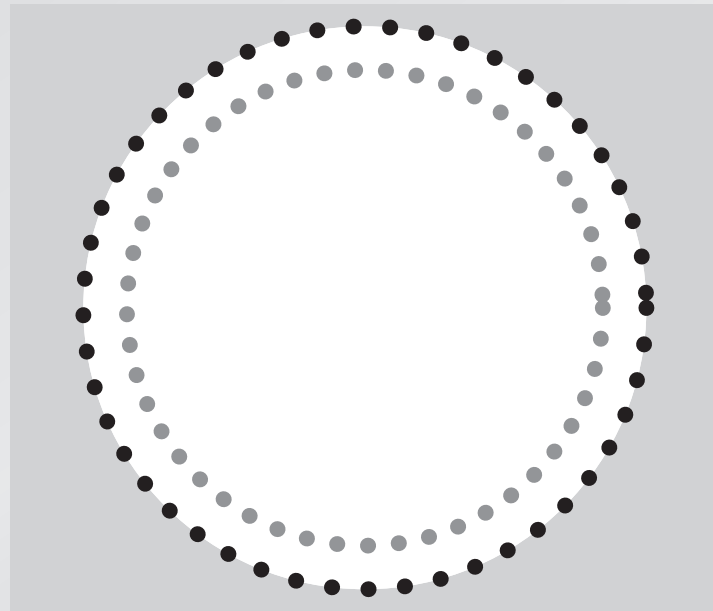

Let's try it!

consider the atoms at the rim of the hole

you won't forget this

A circular diagram consisting of a white center, a ring of grey dots, and an outer ring of black dots. The text "you won't forget this" is written in a large, bold, red, sans-serif font, slanted upwards from left to right, and is superimposed over the circular diagram.

Results

is it any good?

Results

first year of implementing PI

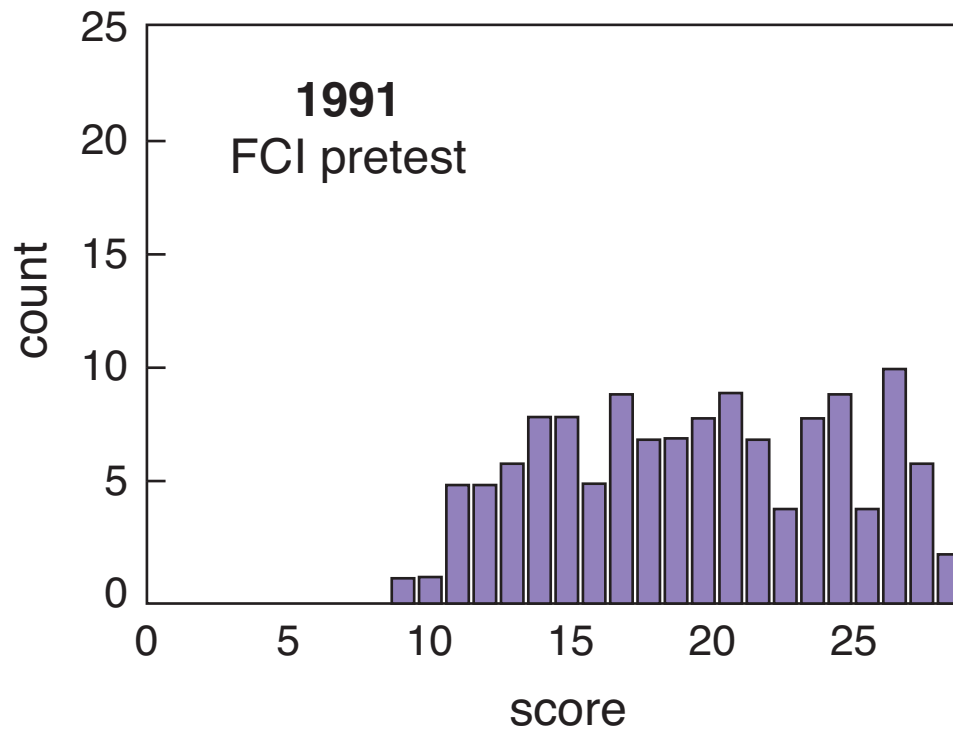

Results

first year of implementing PI

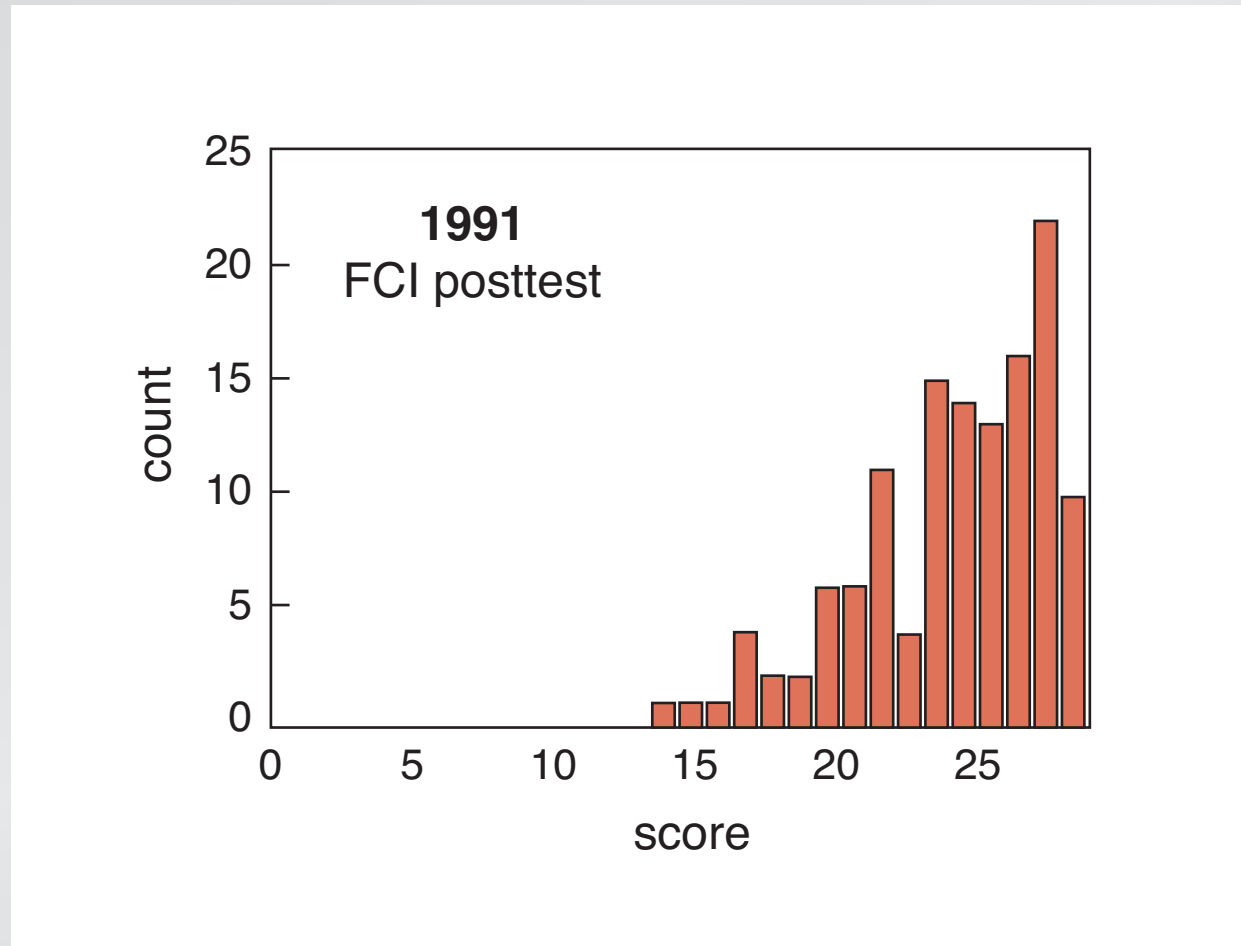

Results

first year of implementing PI

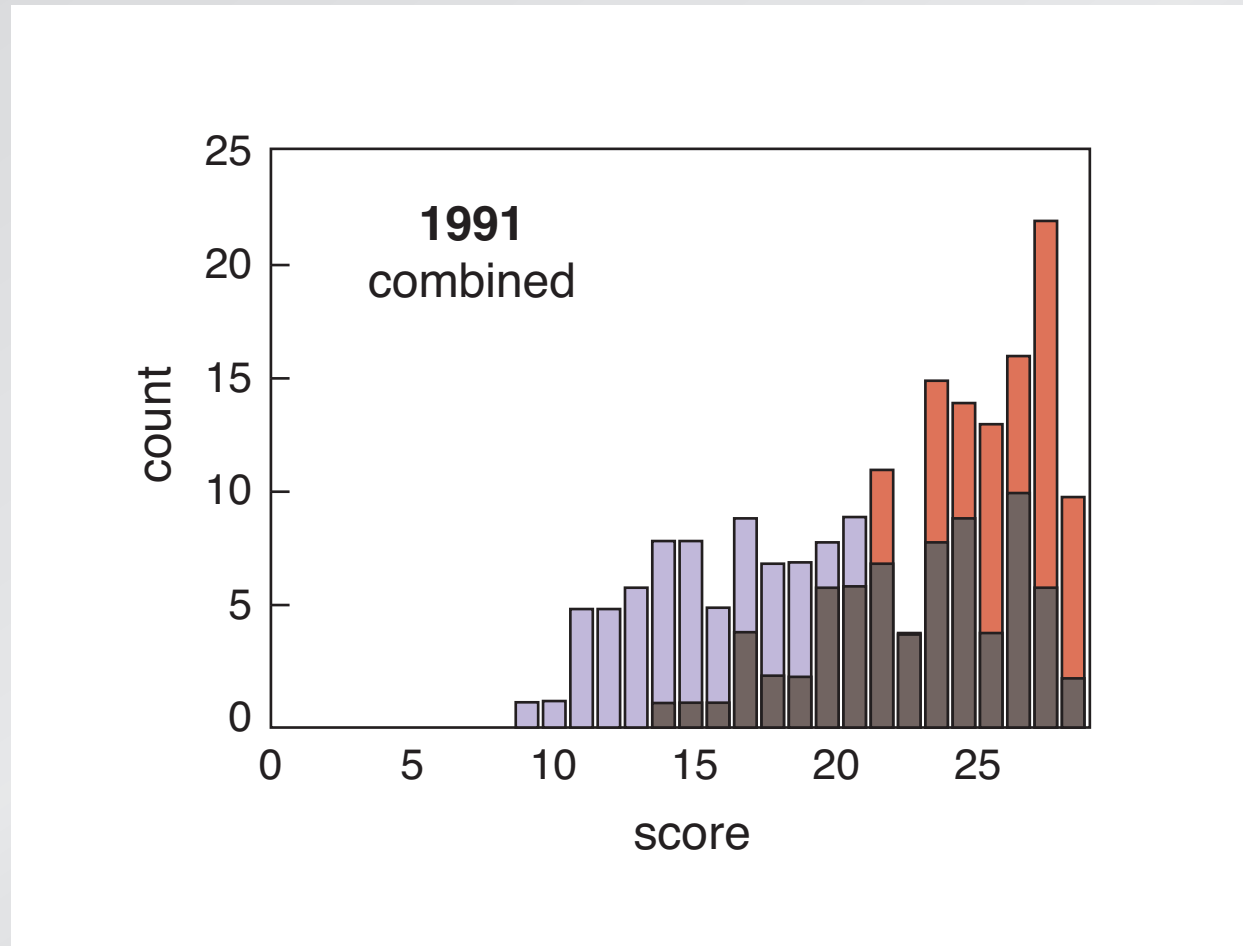

Results

what about problem solving?

Results

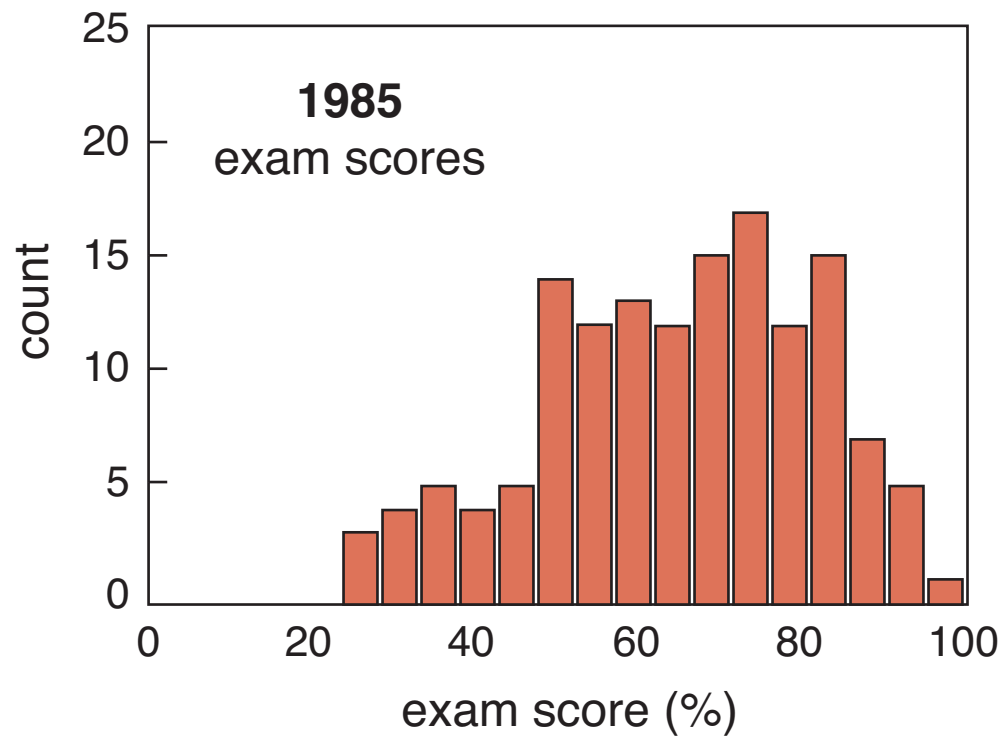

Results

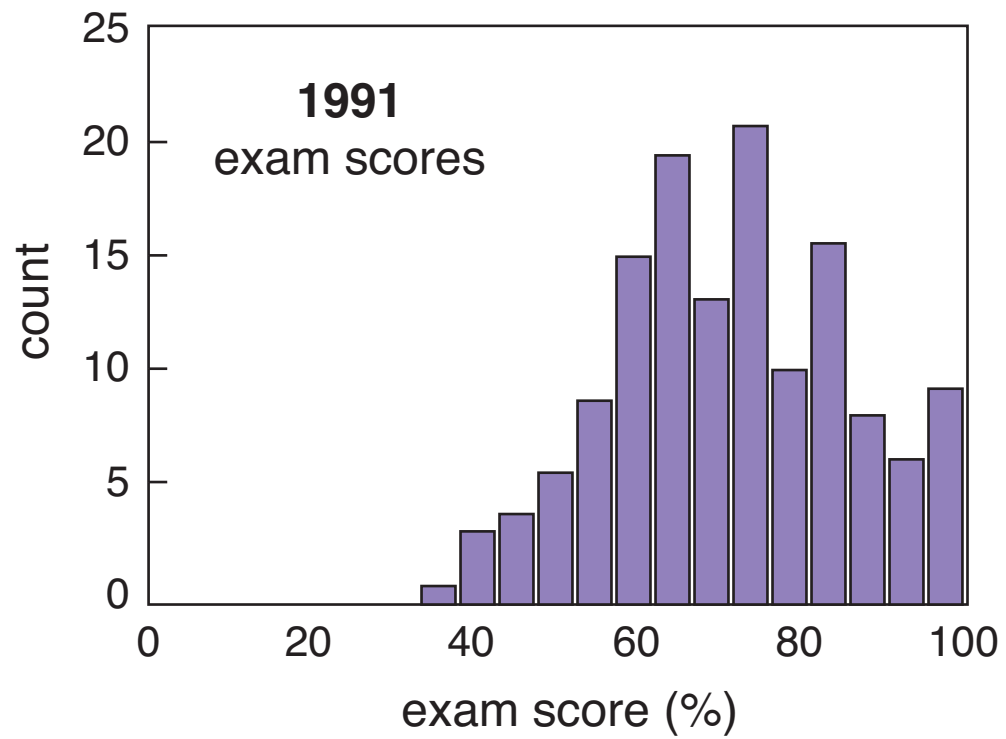

Results

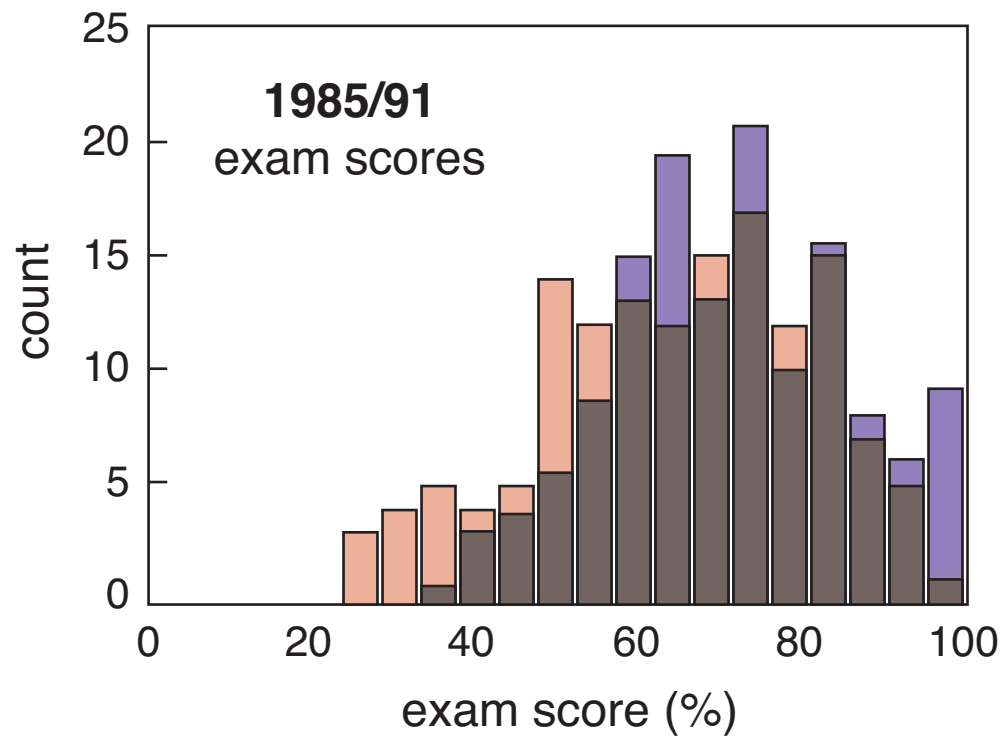

Conclusion

**So better understanding leads to better
problem solving!**

Conclusion

So better understanding leads to better problem solving!

(but “good” problem solving doesn’t always indicate understanding!)

Funding:

National Science Foundation

for a copy of this presentation:

<http://mazur.harvard.edu>

Follow me!



eric_mazur

Google™

Google Search

I'm Feeling Lucky

Google™

mazur

Google Search

I'm Feeling Lucky

Google™

Google Search

I'm Feeling Lucky

Google™

Google Search

I'm Feeling Lucky

Funding:

National Science Foundation

for a copy of this presentation:

<http://mazur.harvard.edu>

Follow me!



eric_mazur