

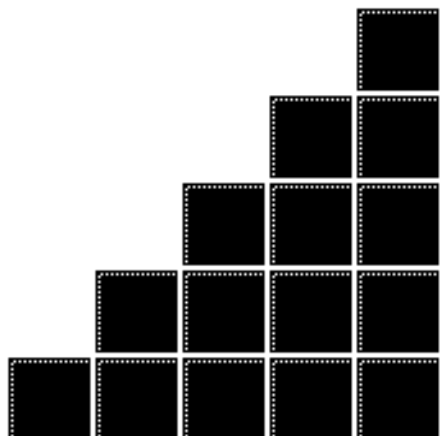

UNDERSTANDING OR MEMORIZATION: ARE WE TEACHING THE RIGHT THING?

Eric Mazur
Harvard University

MRSEC Education Outreach Workshop
UCSB
22 October 1998



HARVARD MRSEC OUTREACH

- Project TEACH
- Teacher workshops
- REU & Industrial Internship Program

<http://www.mrsec.harvard.edu>



① Problem

② Cause

③ Remedy

THE PROBLEM

- frustration
- lower enrollments
- lack of innovation

**They're
Not
Dumb.
They're
Different**
Stalking the
Second Tier

The American Enterprise Institute for Public Policy Research



FRUSTRATION



FRUSTRATION

“In a perfect world...

...algebra would actually come in handy.”



FRUSTRATION



FRUSTRATION

Hot is a relative term. Given temperatures rise regardless of mass. Galileo observed rising temperatures will decrease with the exposure of an endothermic source. True transperence will persist until this one irresistible calorie interacts thus altering the system.



FRUSTRATION



FRUSTRATION

“I took four years of science
and four years of math...

A waste of my time, a waste of
the teacher's time, and a
waste of space...

You know, I took
physics. For *what?*”

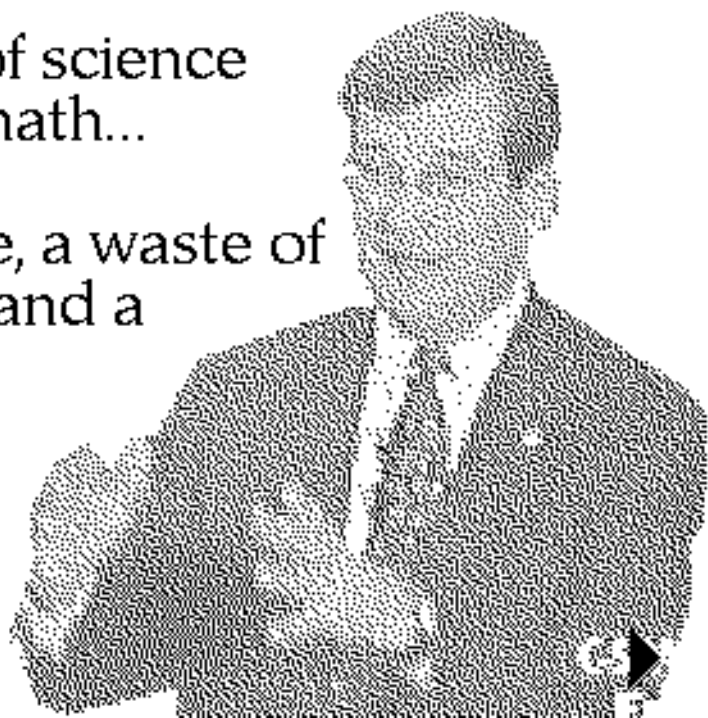

FRUSTRATION



① Problem

② Cause

③ Remedy

THE CAUSE

Are we teaching the right thing...?

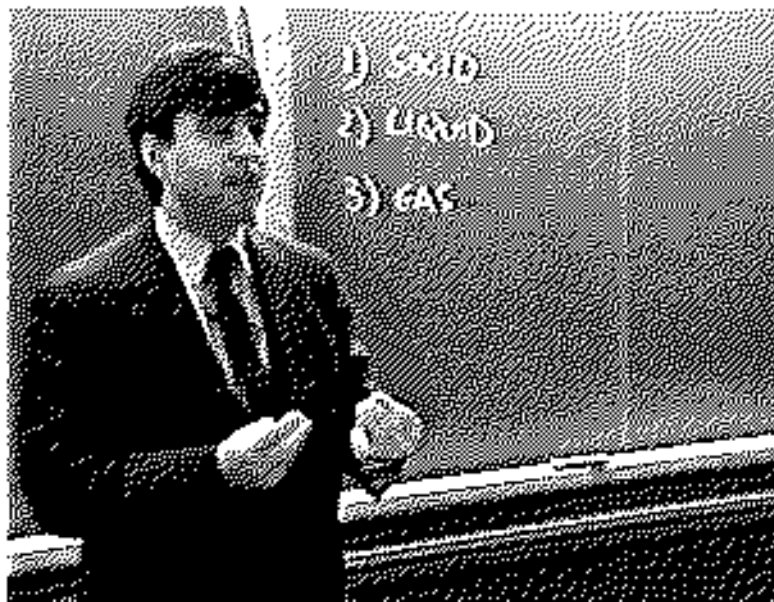

THE CAUSE

Traditional question:

Calculate:

- (a) the current in the $2\text{-}\Omega$ resistor, and
- (b) the potential difference between points a and b .

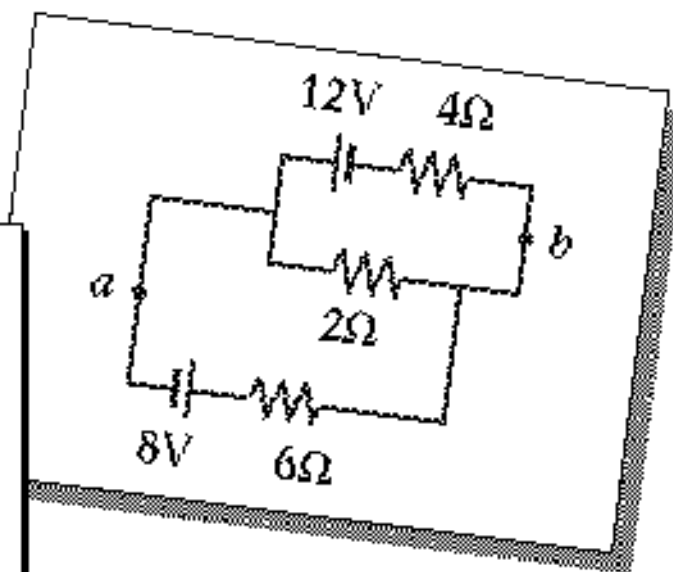

THE CAUSE

Conceptual question:

When S is closed, what happens to the:

- (a) intensities of A and B ?
- (b) intensity of C ?
- (c) current through battery?
- (d) voltage drop across A , B , and C ?
- (e) total power dissipated?

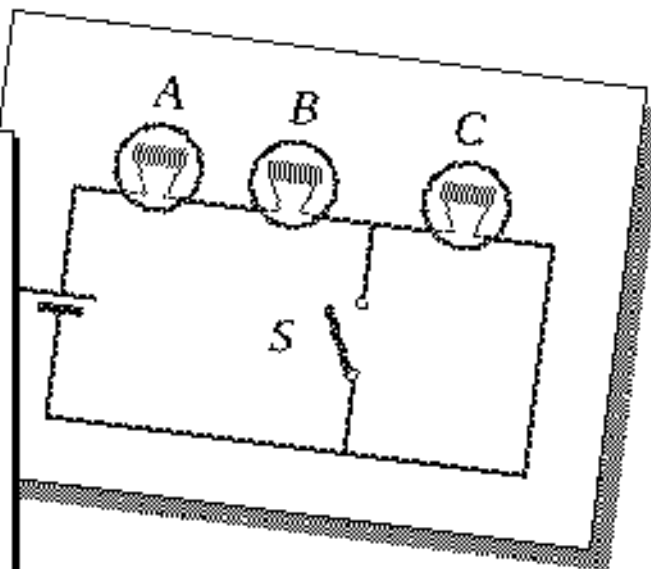

THE CAUSE

Results

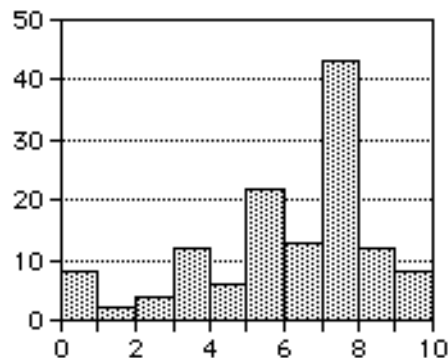

Traditional

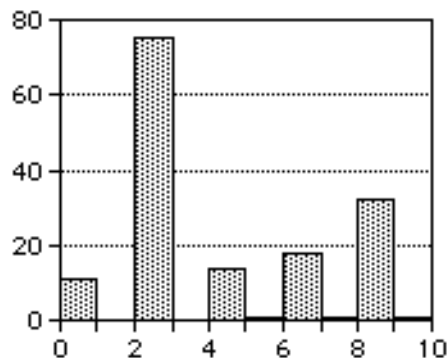

Conceptual



THE CAUSE

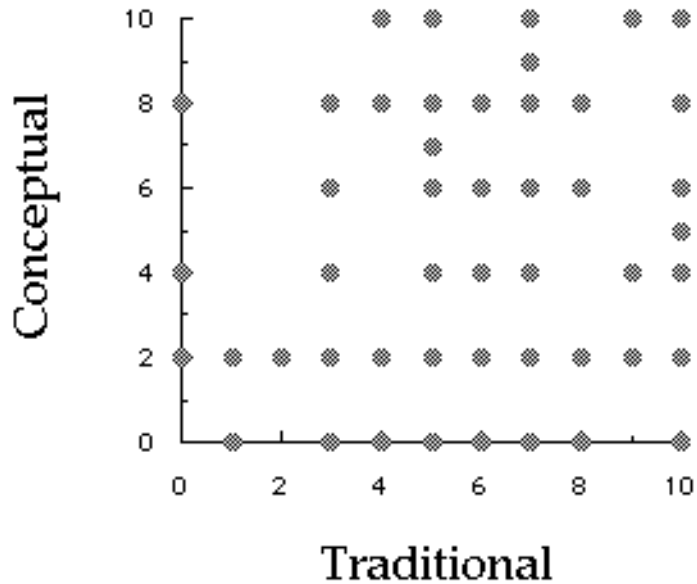

THE CAUSE

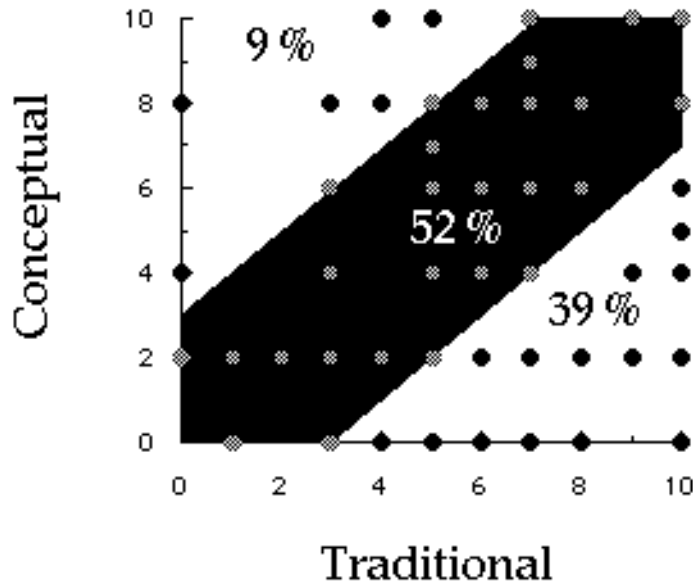

① Problem

② Cause

③ Remedy

THE REMEDY

Peer Instruction:

- Reading assignments
- Lectures
- 'ConceptTests'
- Feedback

PEER INSTRUCTION

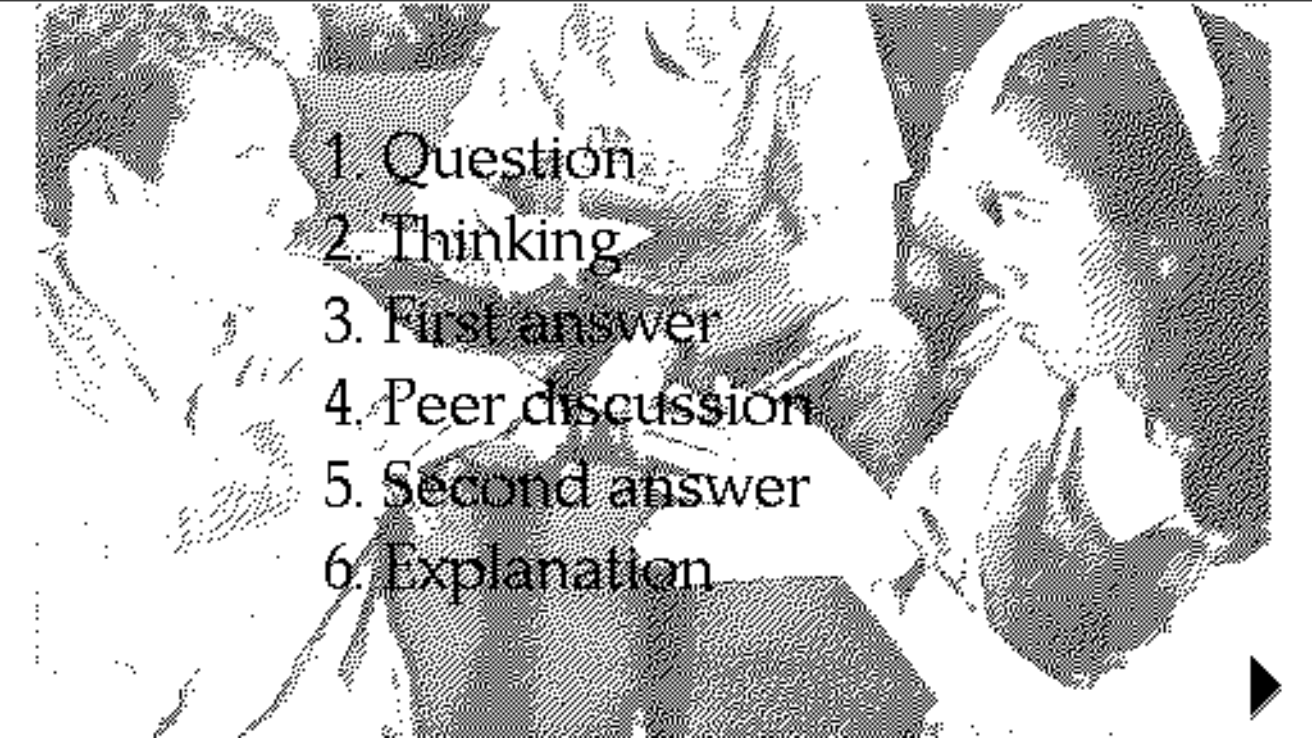
- 
1. Question
 2. Thinking
 3. First answer
 4. Peer discussion
 5. Second answer
 6. Explanation

PEER INSTRUCTION

before:

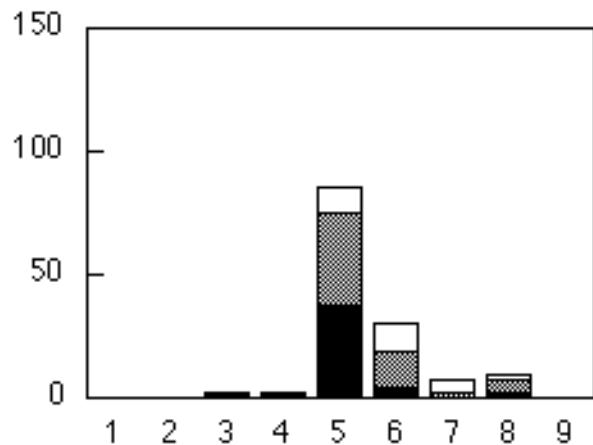

Just guessing...

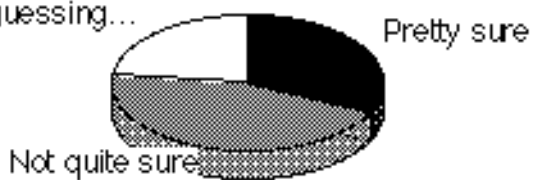

PEER INSTRUCTION

after:

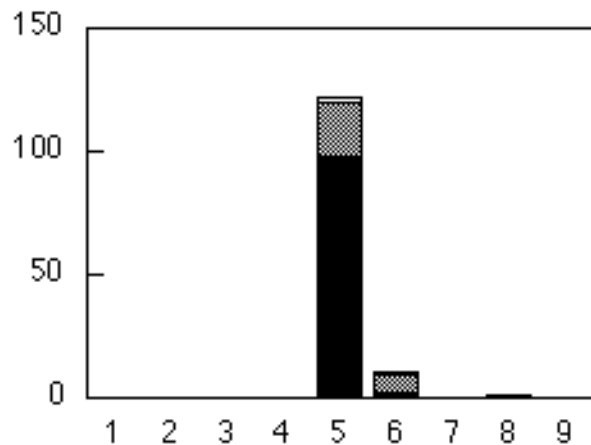

PEER INSTRUCTION

% correct answers (weighted)

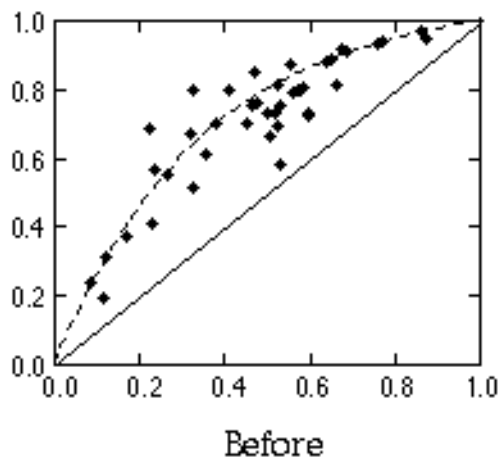
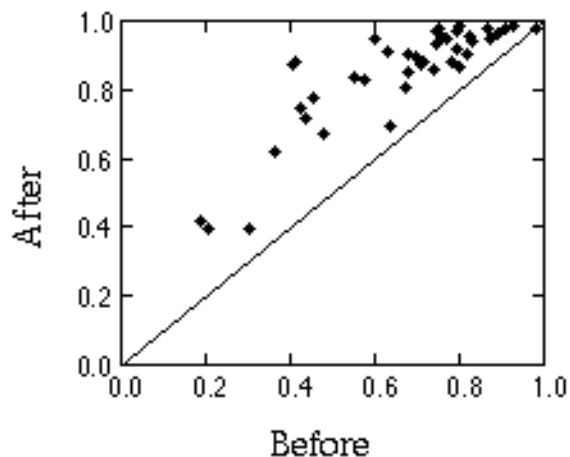

Is it any good...?

- ① Results
- ② Student reactions

Results

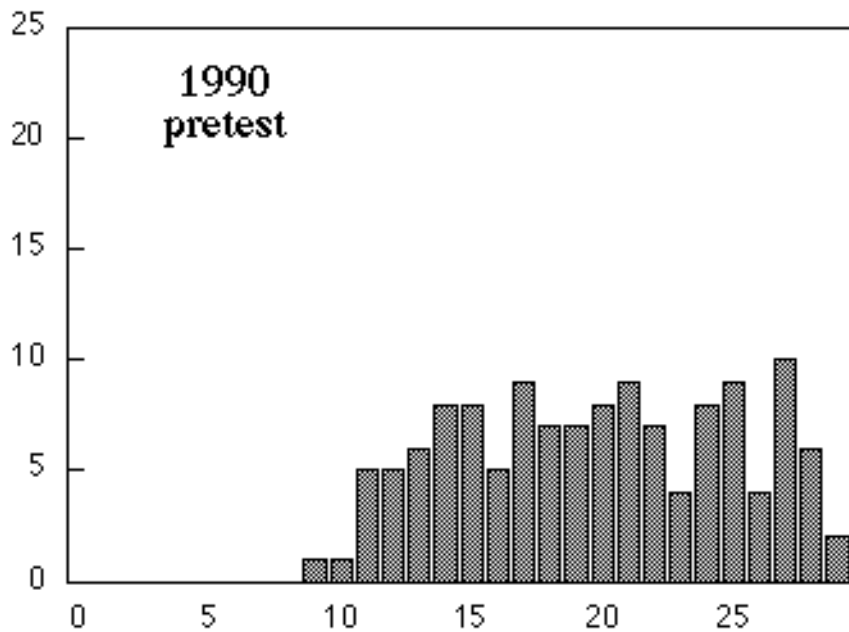

Results

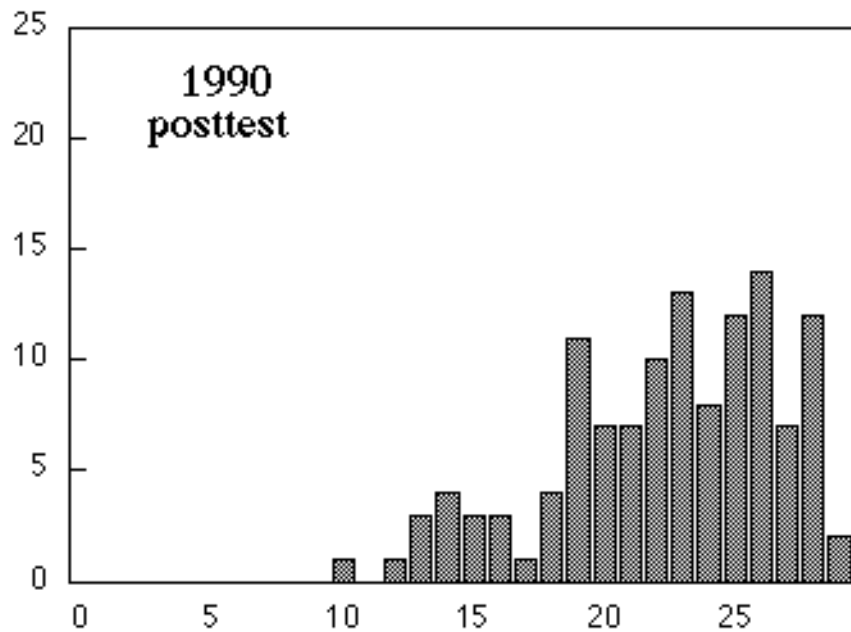

Results

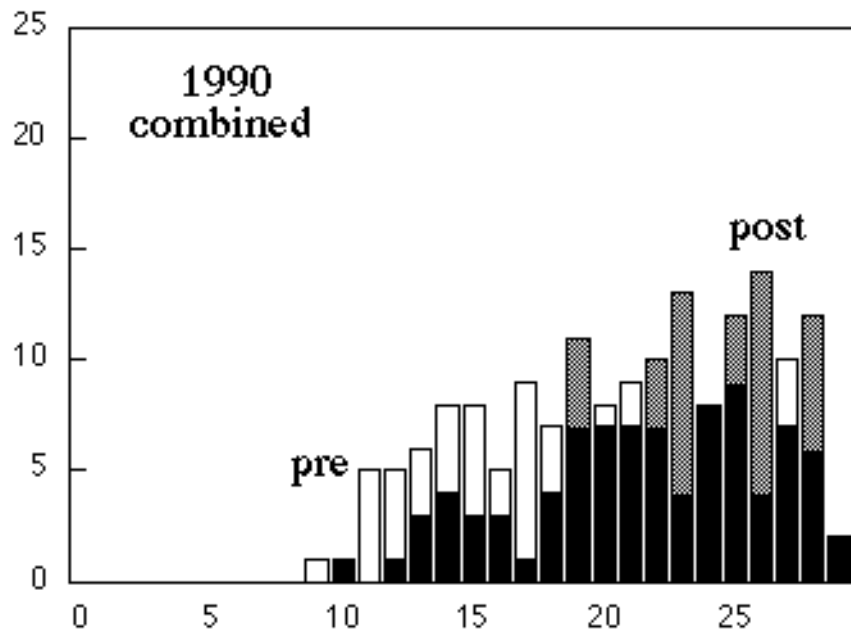

Results

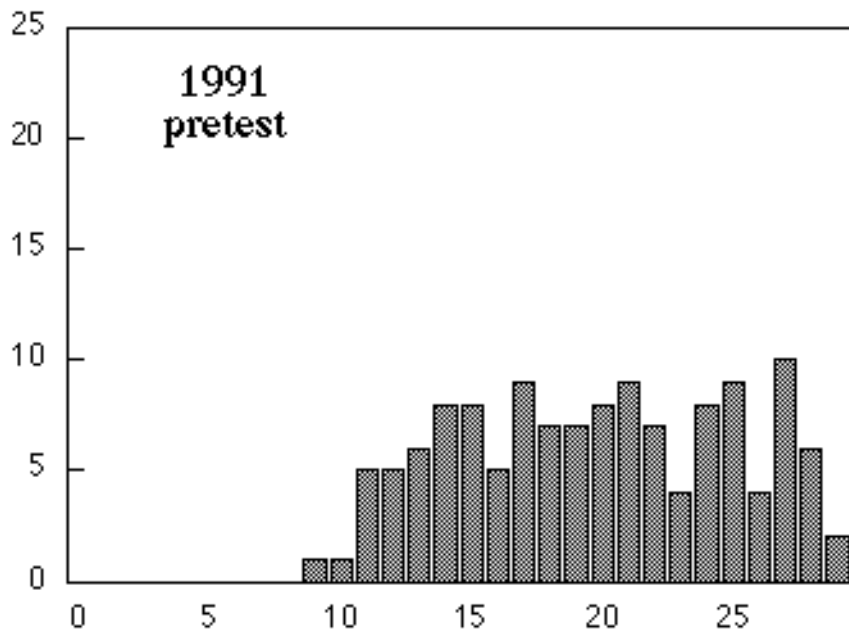

Results

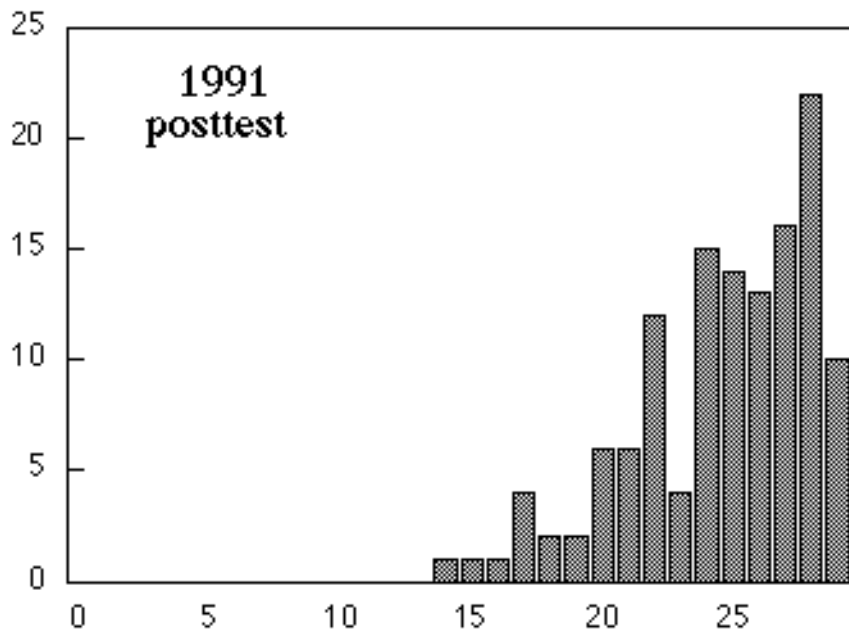

Results

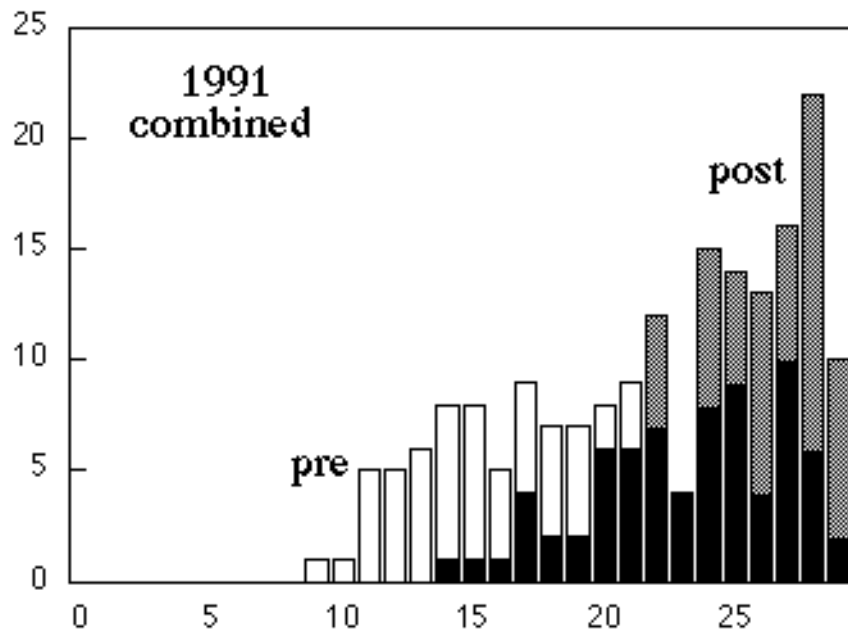

Results

What about problem solving...?



Results

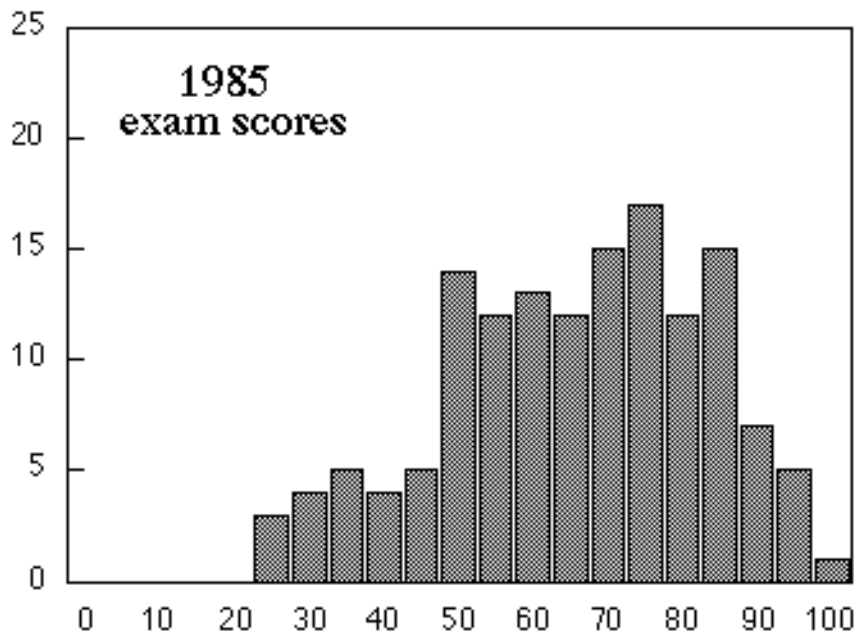

Results

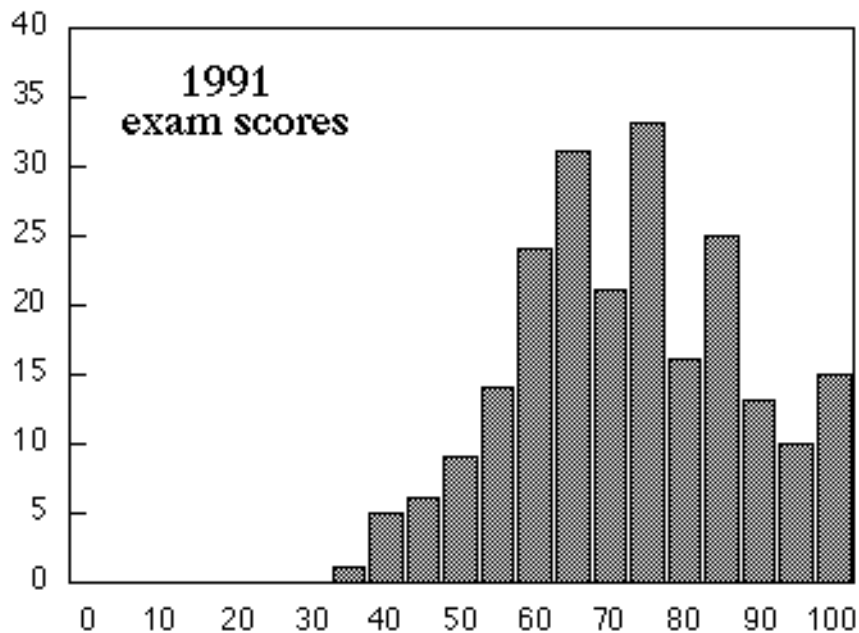

Results

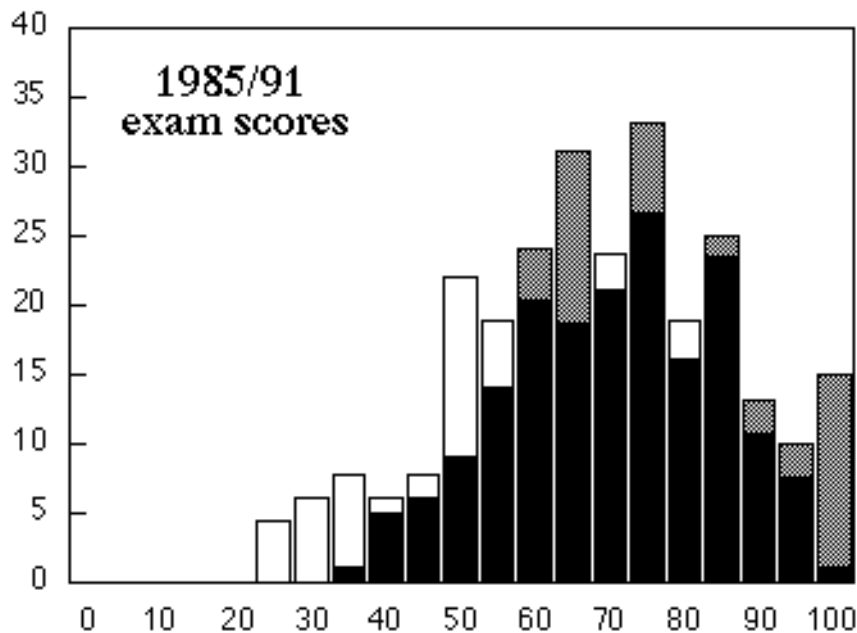

Is it any good...?

- ① Results
- ② Student reactions

STUDENT REACTIONS



Acknowledgments

Deborah Alpert (Harvard)
Michael Aziz (Harvard)
William Paul (Harvard)
Robert Westervelt (Harvard)
Bob Flaherty (Apple Computer)
David Hestenes (ASU)
Andrew McKinney (Harvard)

<http://galileo.harvard.edu>

