

Less is more: Extreme optics with zero refractive index



@eric_mazur

NUS

Singapore, 24 August 2016



Less is more: Extreme optics with zero refractive index

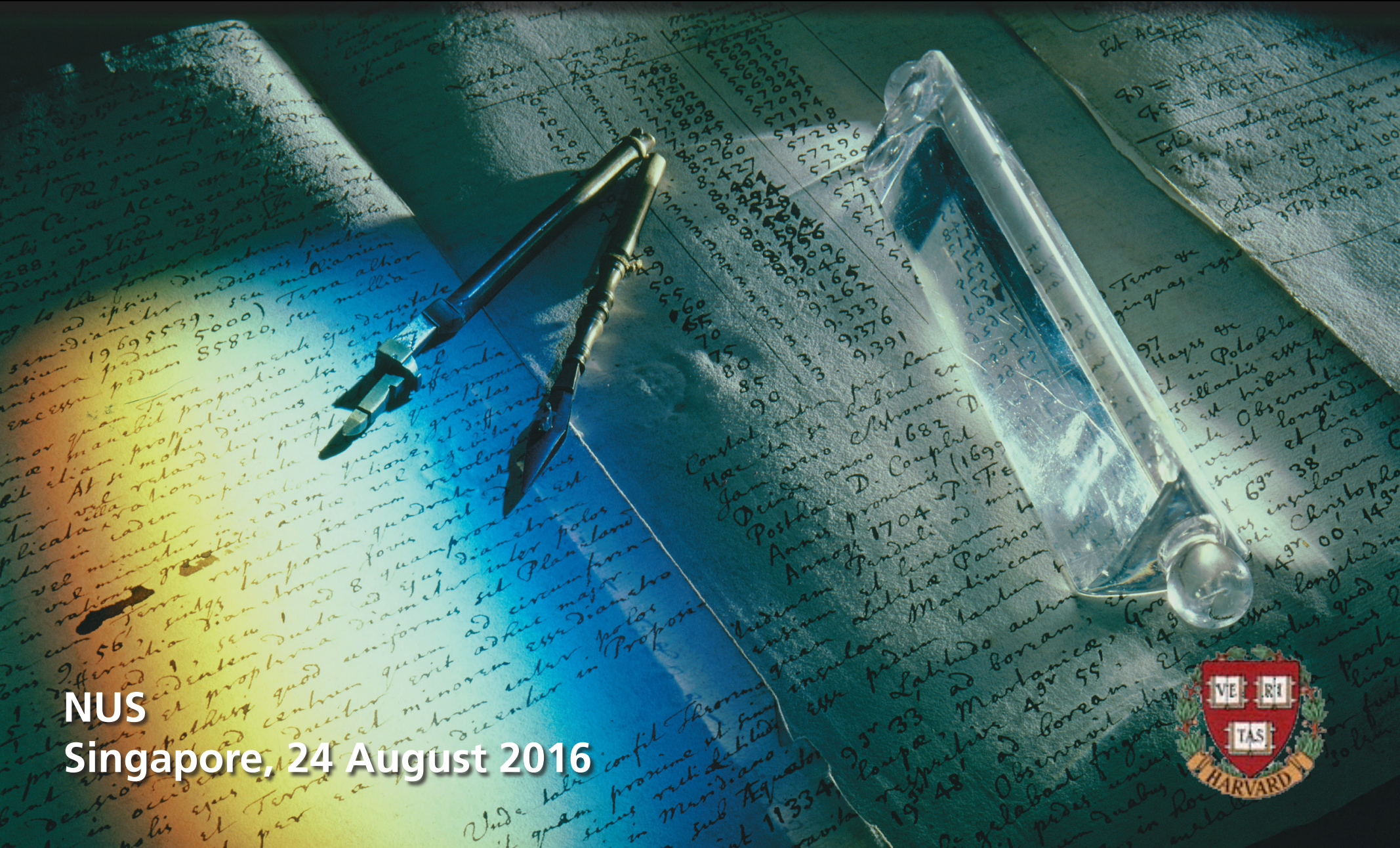

NUS
Singapore, 24 August 2016



OSA[®] | 100

Reflecting a Century of Innovation

Less is more: Extreme optics with zero refractive index

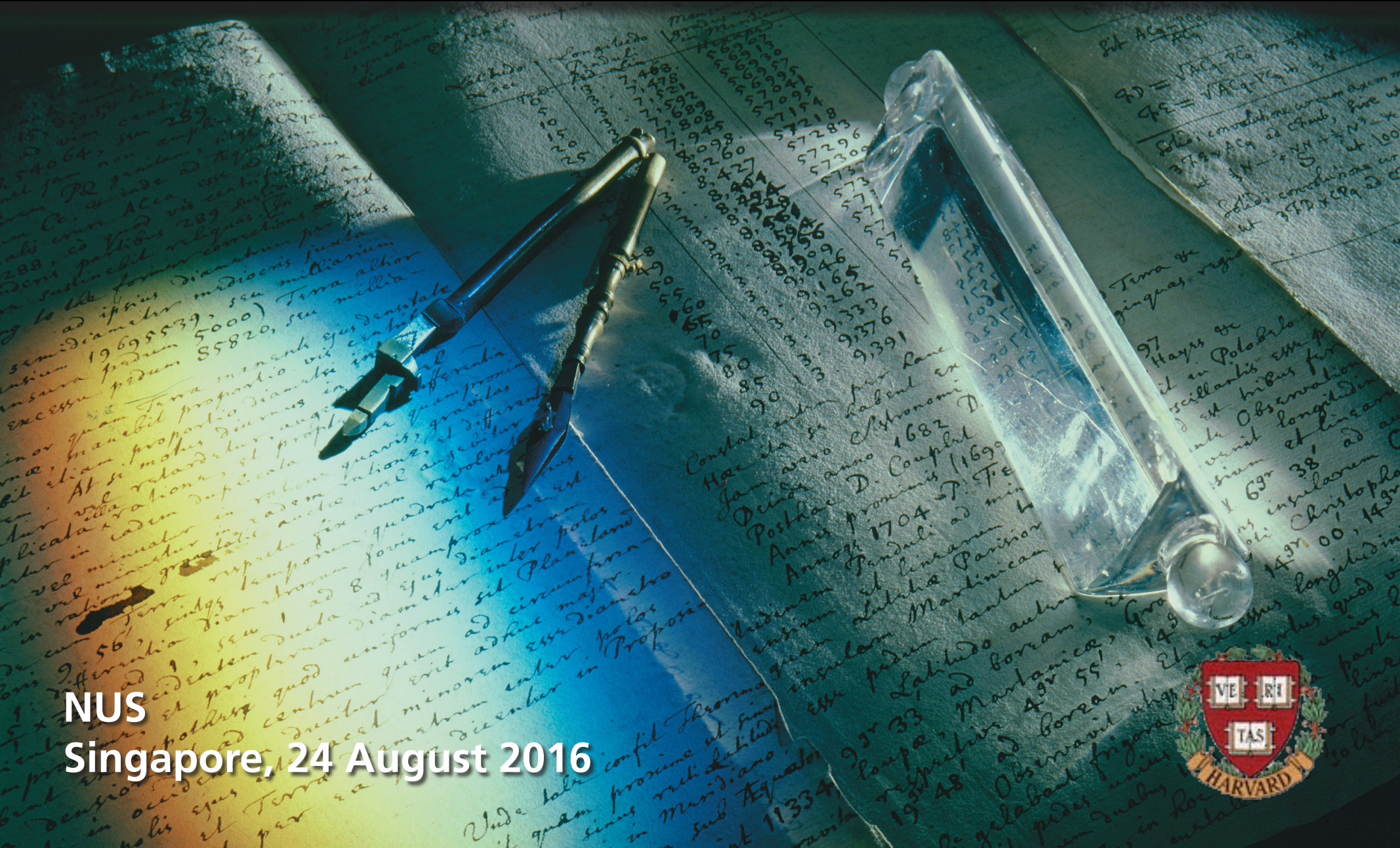

NUS
Singapore, 24 August 2016





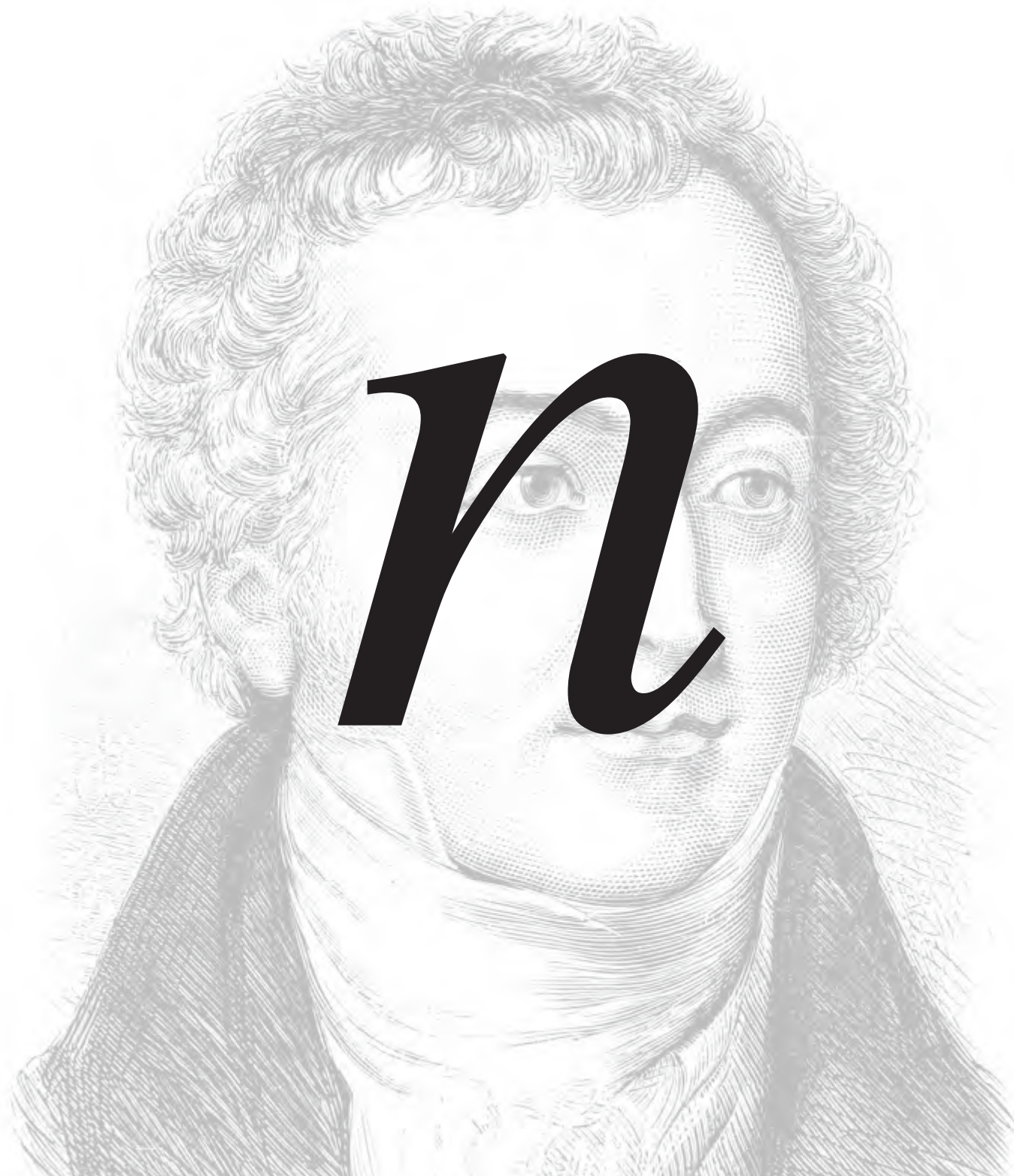

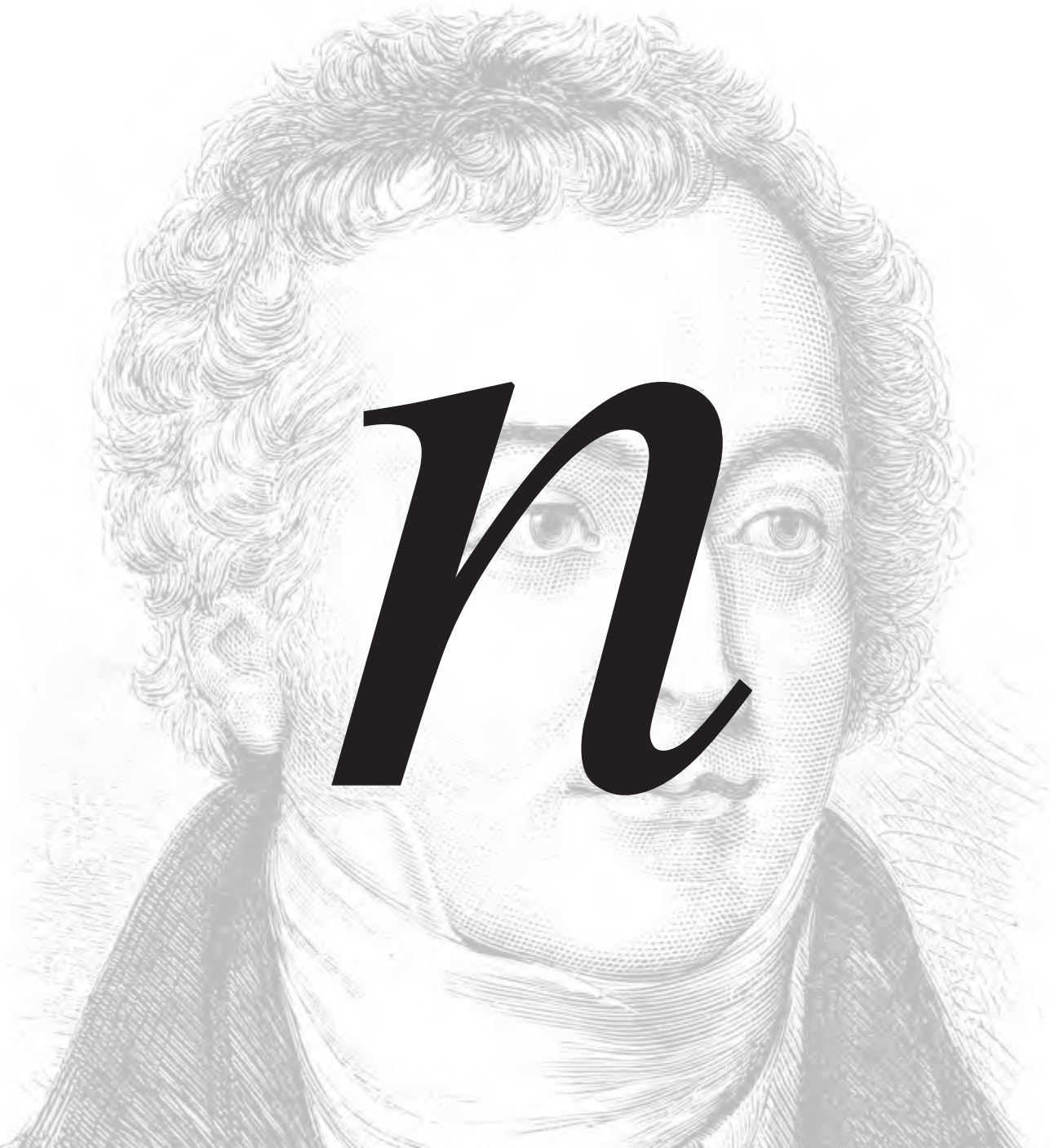

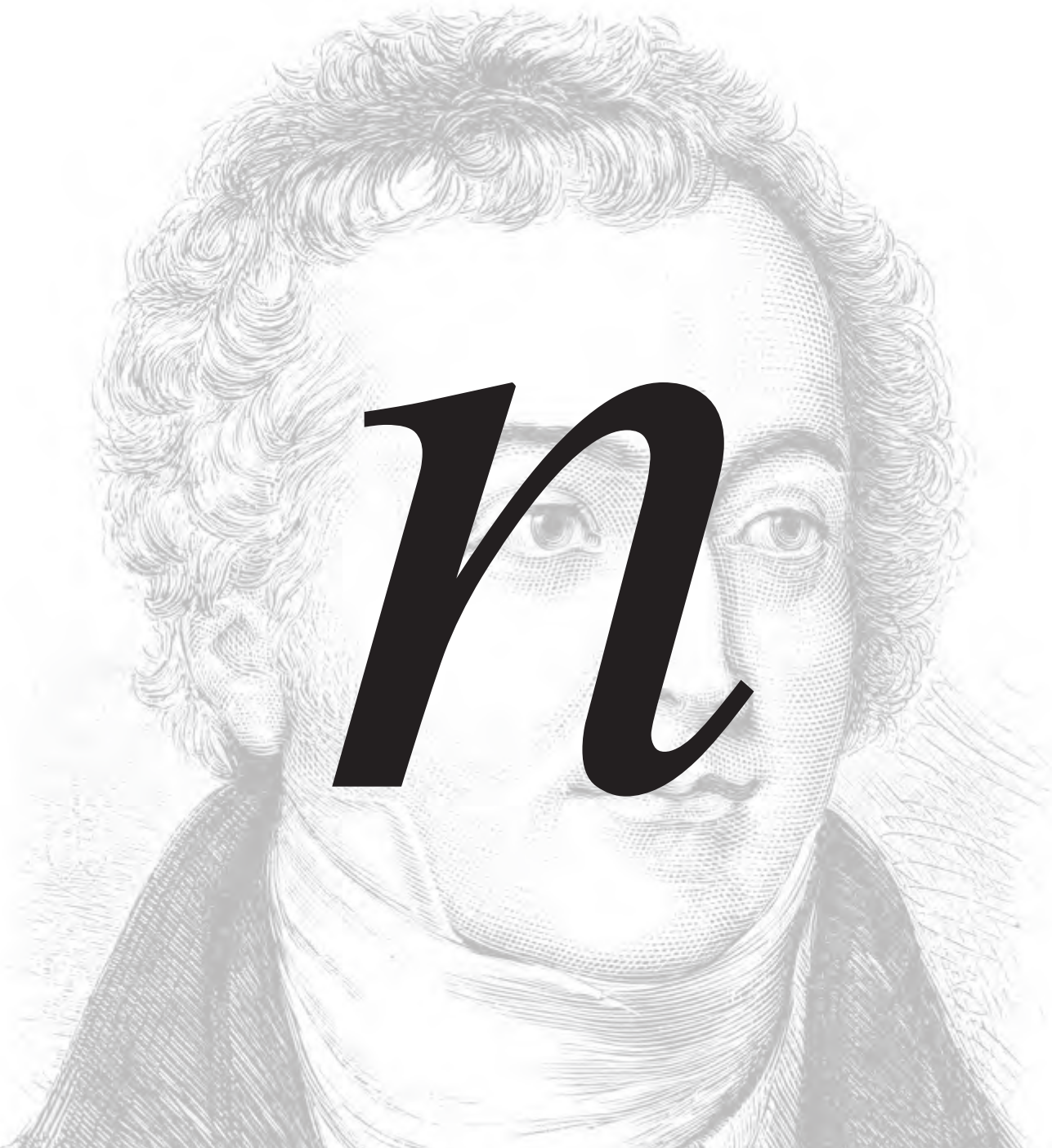

1 index

2 zero index

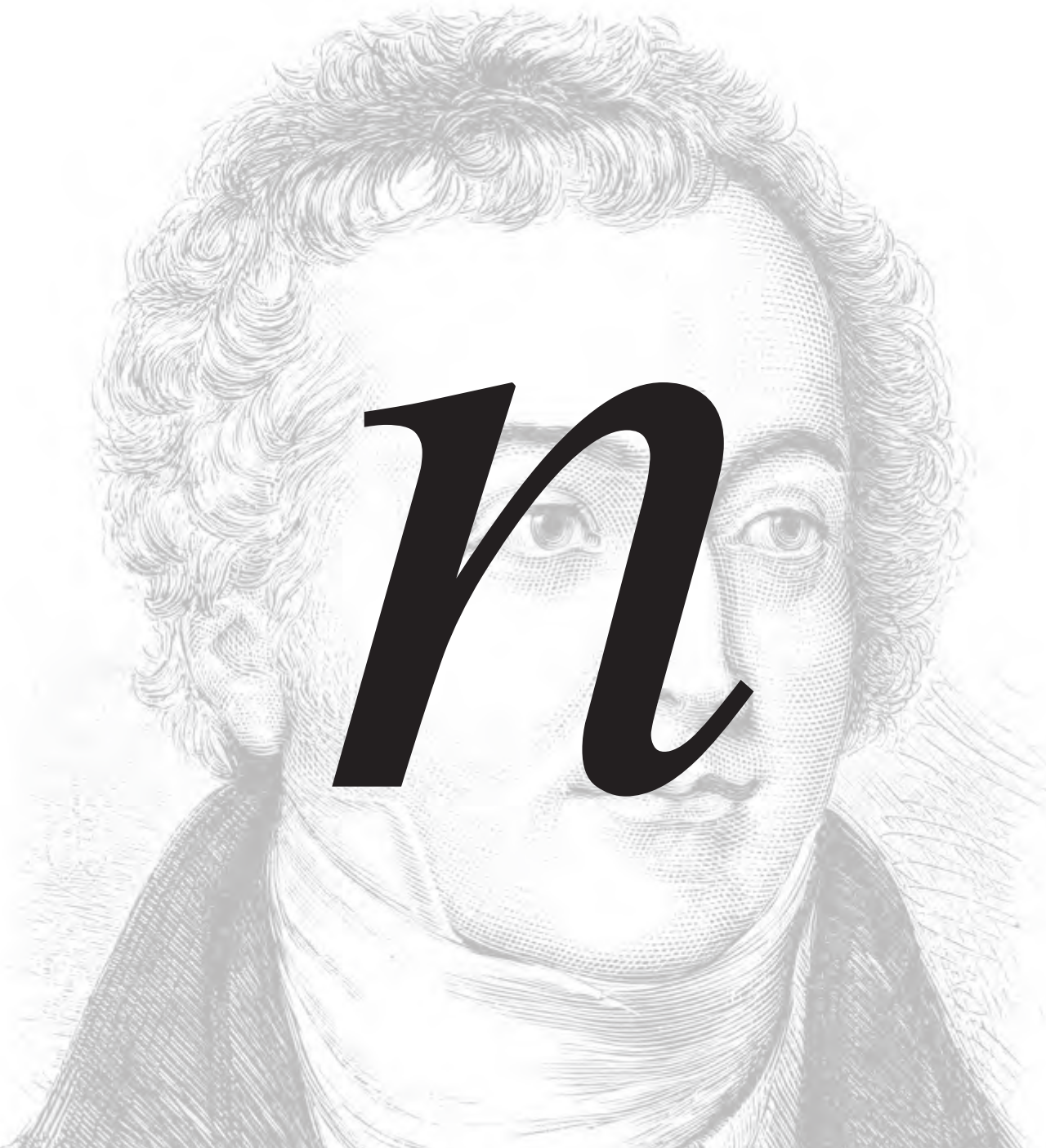

1 index

2 zero index

3 experiments

Propagation of EM wave

Propagation of EM wave

governed by wave equation

$$\nabla^2 \vec{E} - \frac{\mu\epsilon}{c^2} \frac{\partial^2 \vec{E}}{\partial t^2} = 0$$

Propagation of EM wave

governed by wave equation

$$\nabla^2 \vec{E} - \frac{\mu\epsilon}{c^2} \frac{\partial^2 \vec{E}}{\partial t^2} = 0$$

Solution:

$$\vec{E} = \vec{E}_o e^{i(kx - \omega t)}$$

Propagation of EM wave

governed by wave equation

$$\nabla^2 \vec{E} - \frac{\mu\epsilon}{c^2} \frac{\partial^2 \vec{E}}{\partial t^2} = 0$$

Solution:

$$\vec{E} = \vec{E}_0 e^{i(kx - \omega t)}$$

where

$$\frac{\omega}{k} = \frac{1}{\sqrt{\epsilon\mu}} c = \frac{1}{n} c$$

Propagation of EM wave

governed by wave equation

$$\nabla^2 \vec{E} - \frac{\mu\epsilon}{c^2} \frac{\partial^2 \vec{E}}{\partial t^2} = 0$$

Solution:

$$\vec{E} = \vec{E}_o e^{i(kx - \omega t)}$$

where

$$\frac{\omega}{k} = \frac{1}{\sqrt{\epsilon\mu}} c = \frac{1}{n} c$$

and

$$n = \sqrt{\epsilon\mu} .$$

Propagation of EM wave

governed by wave equation

$$\nabla^2 \vec{E} - \frac{\mu\epsilon}{c^2} \frac{\partial^2 \vec{E}}{\partial t^2} = 0$$

Solution:

$$\vec{E} = \vec{E}_0 e^{i(kx - \omega t)}$$

where

$$\frac{\omega}{k} = \frac{1}{\sqrt{\epsilon\mu}} c = \frac{1}{n} c$$

and

$$n = \sqrt{\epsilon\mu} .$$

In dispersive media $n = n(\omega)$.

Index of refraction

$$n = \sqrt{\epsilon\mu}$$

Index of refraction

$$n = \sqrt{\epsilon\mu}$$

So $n(\omega)$ determined by response of material to external fields

Index of refraction

$$n = \sqrt{\epsilon\mu}$$

So $n(\omega)$ determined by response of material to external fields

Index of refraction

$$n = \sqrt{\epsilon\mu}$$

So $n(\omega)$ determined by response of material to external fields

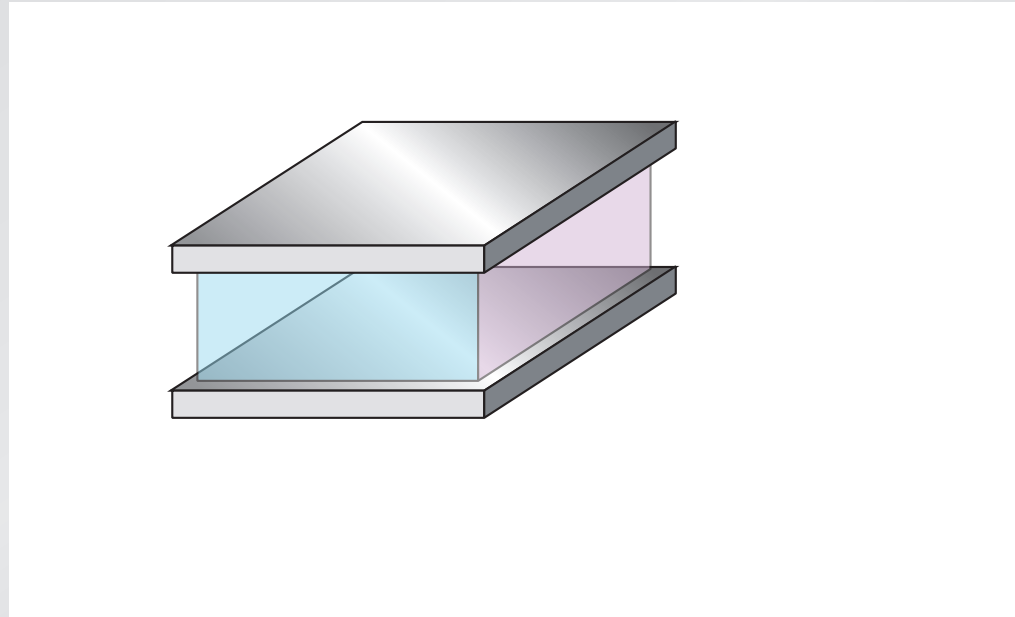

Index of refraction

$$n = \sqrt{\epsilon\mu}$$

So $n(\omega)$ determined by response of material to external fields

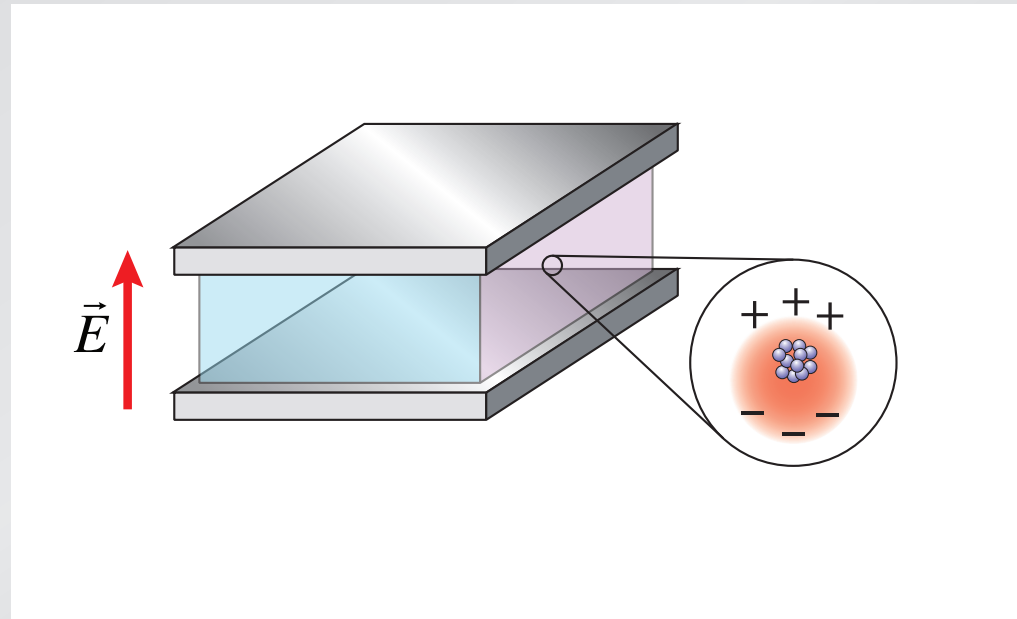

$\epsilon(\omega)$ measure of attenuation of electric field

Index of refraction

$$n = \sqrt{\epsilon\mu}$$

So $n(\omega)$ determined by response of material to external fields

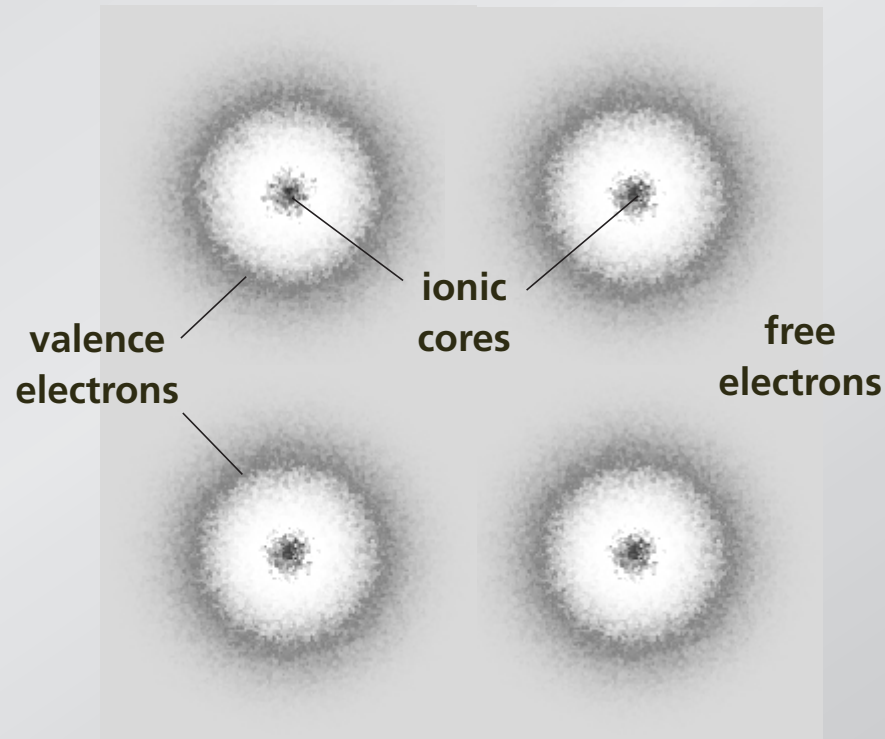

Dielectric constant

Lorentz oscillator

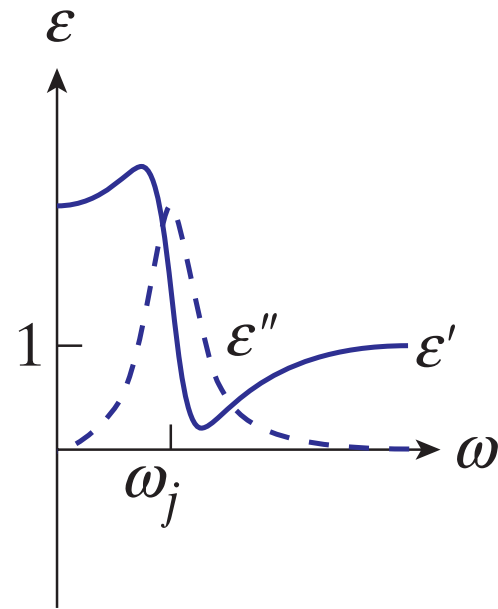

Dielectric constant

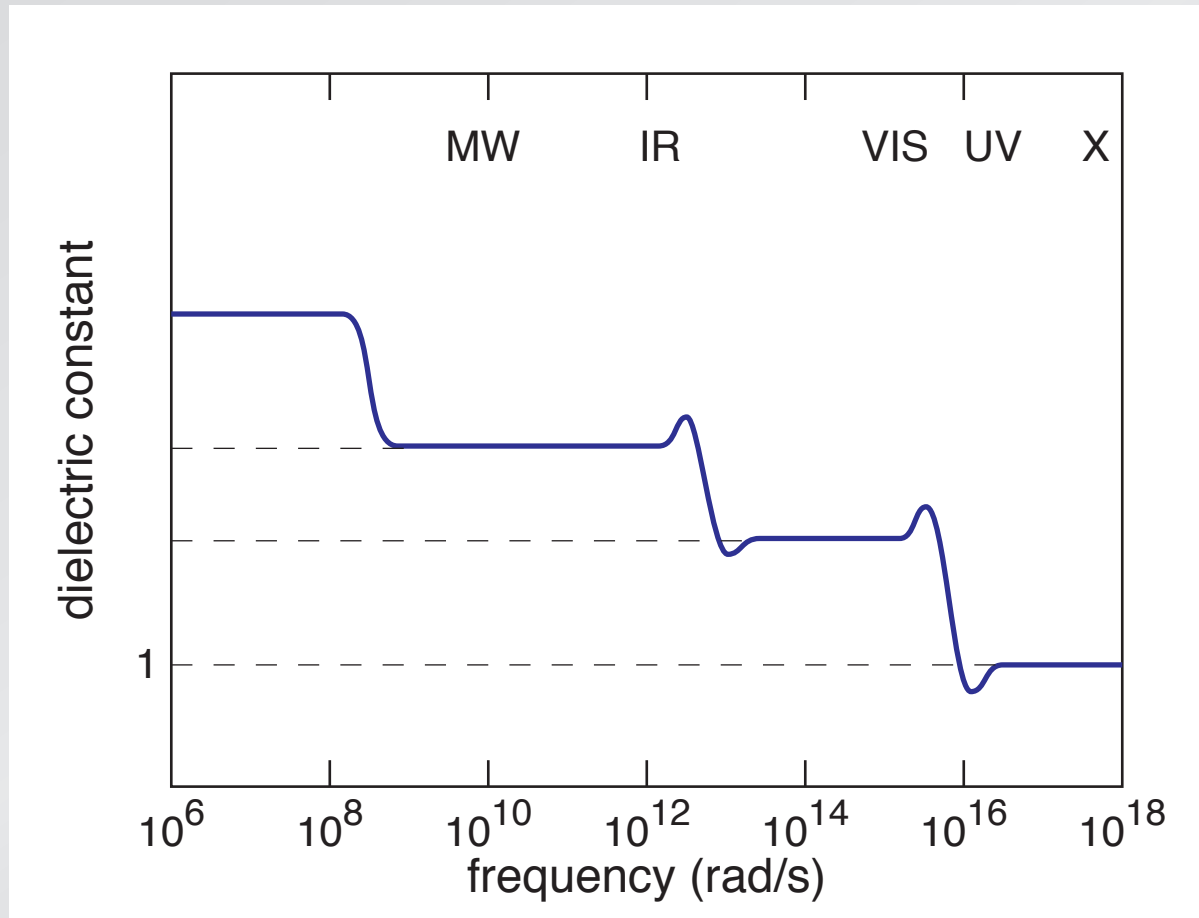

Dielectric constant

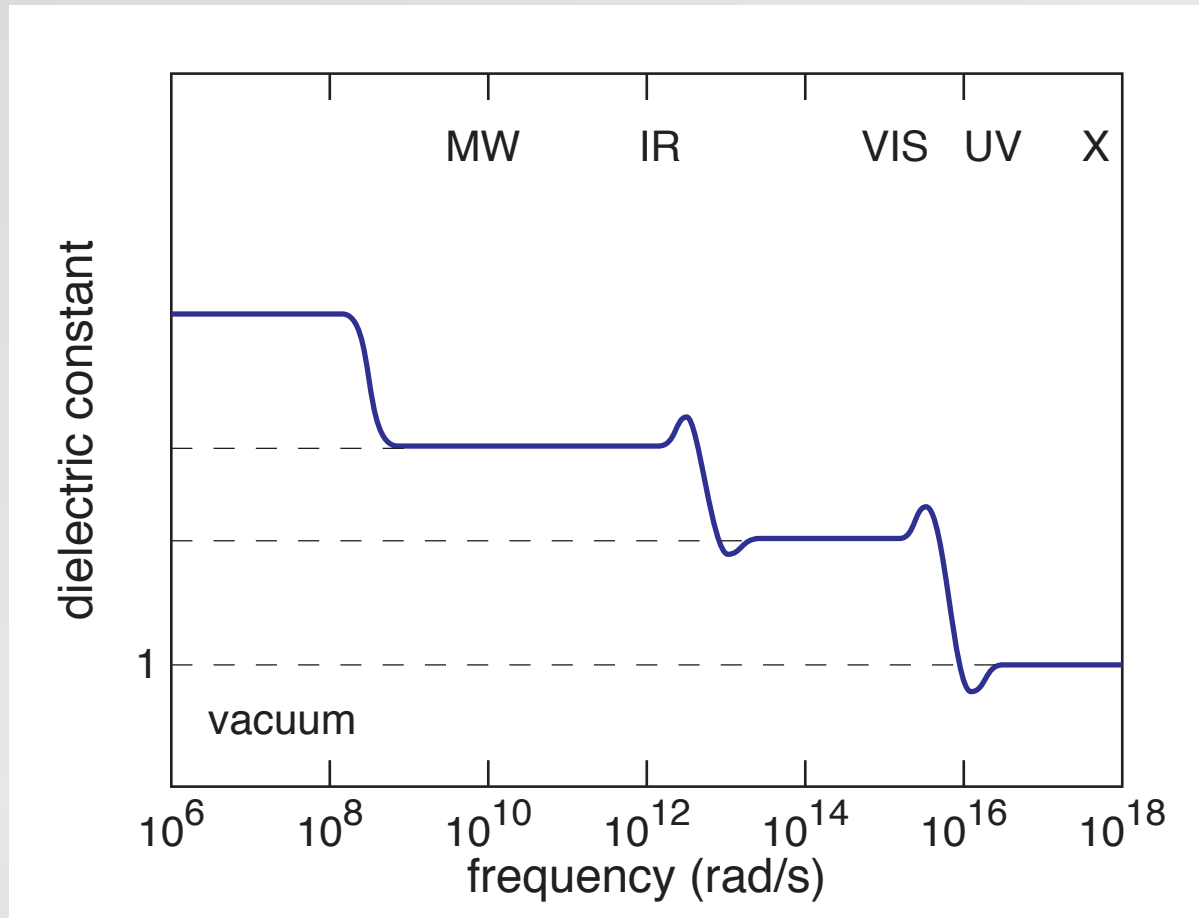

Dielectric constant

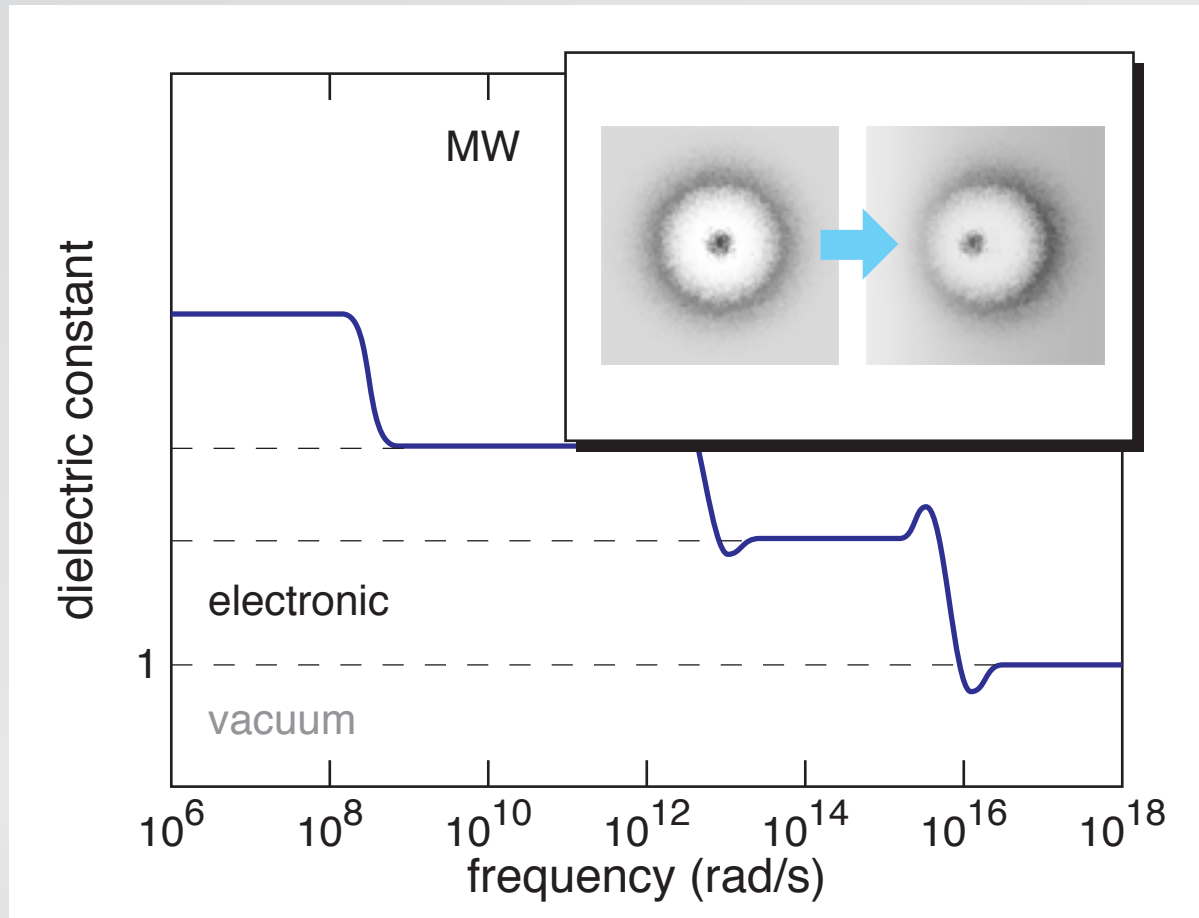

Dielectric constant

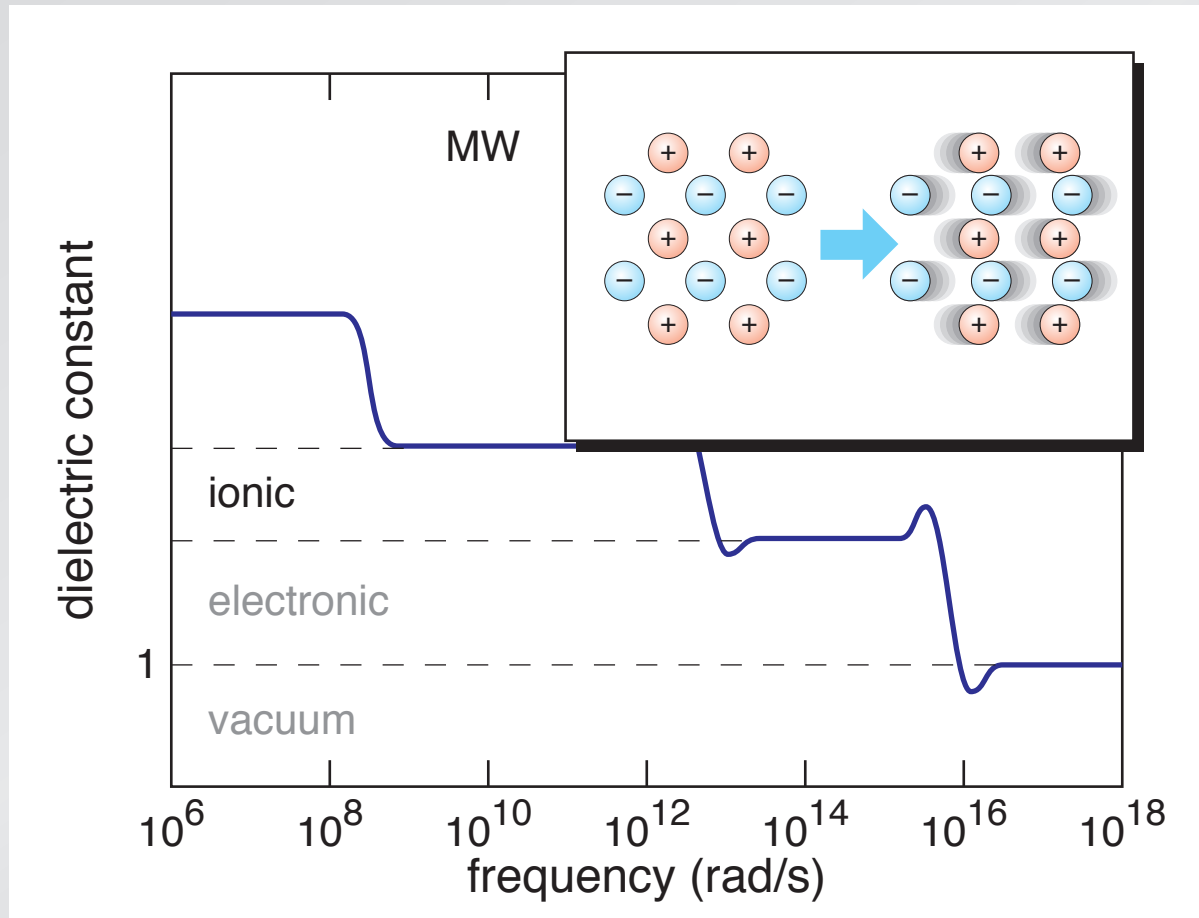

Dielectric constant

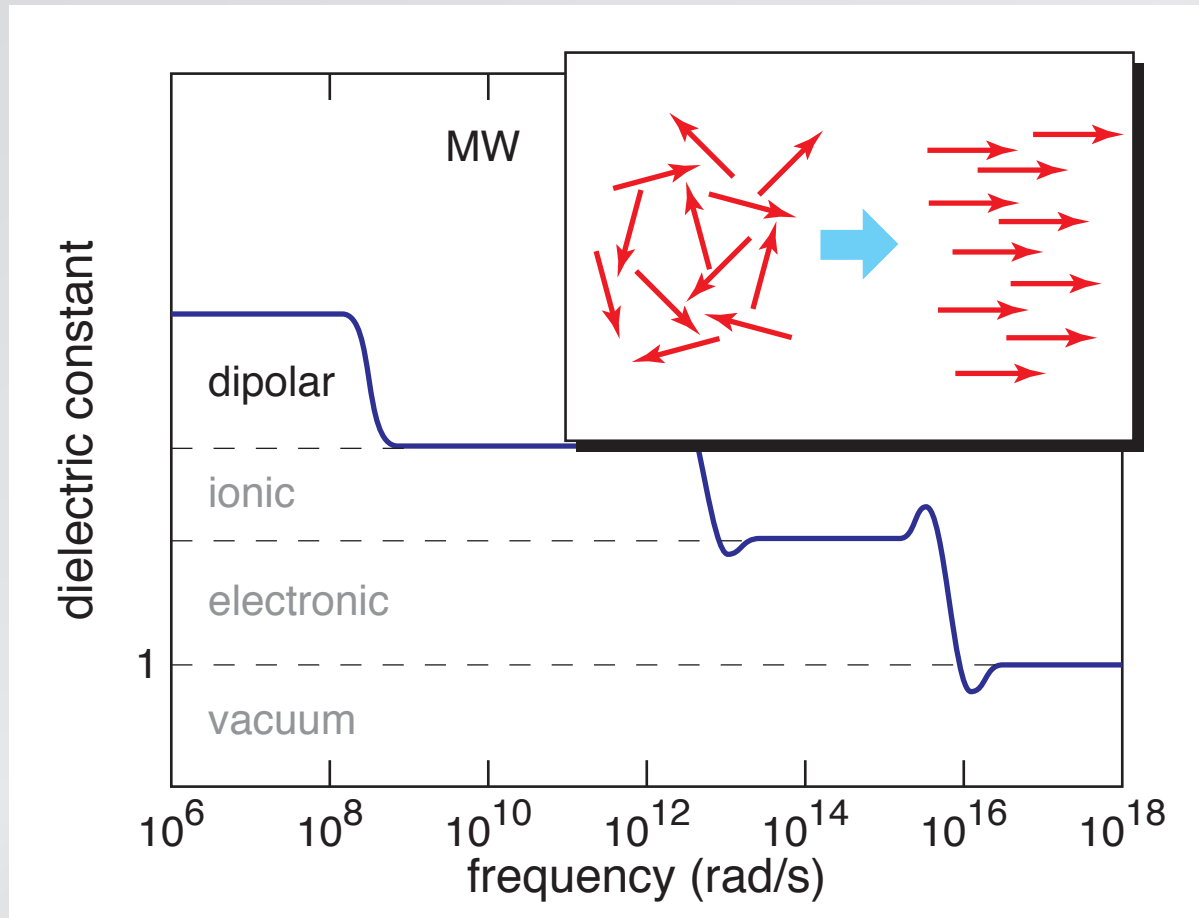

Dielectric constant

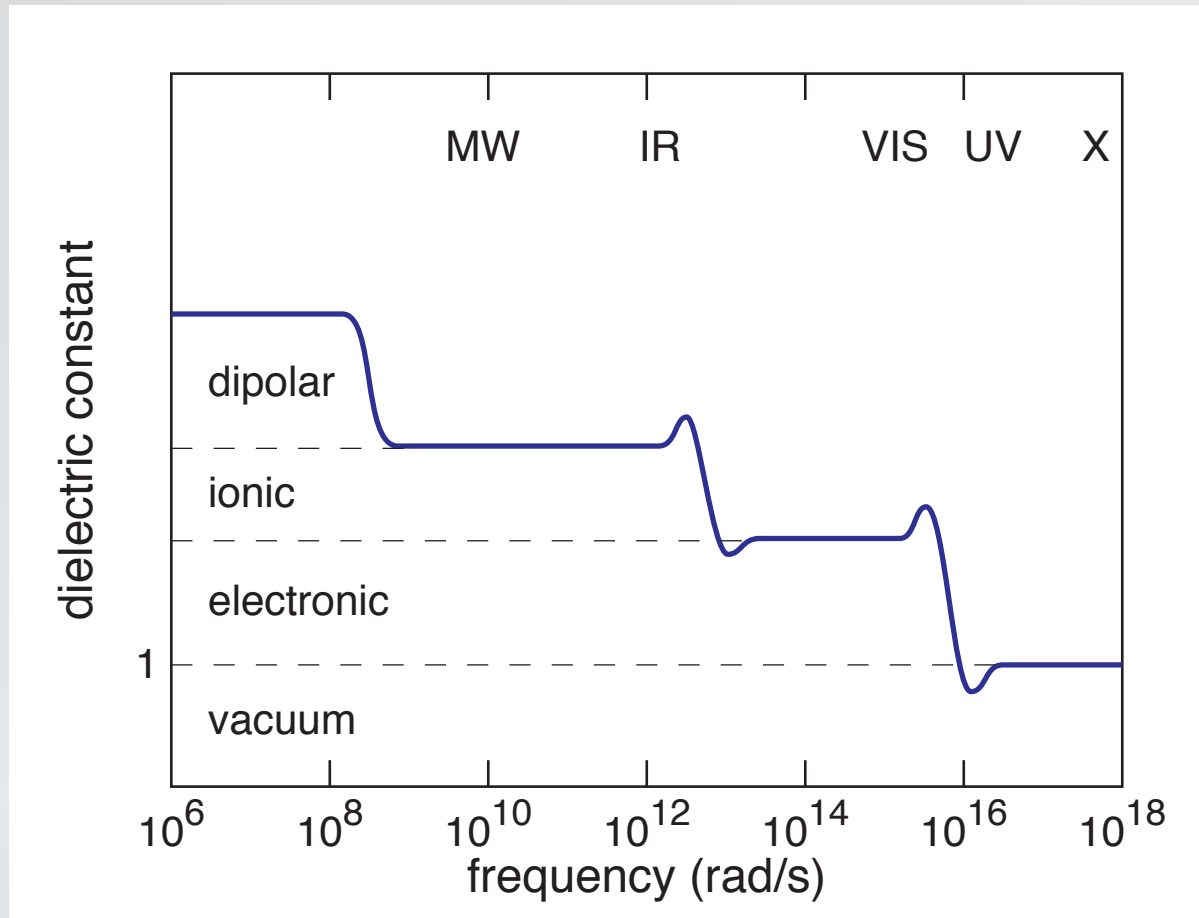

Lorentz and Drude models

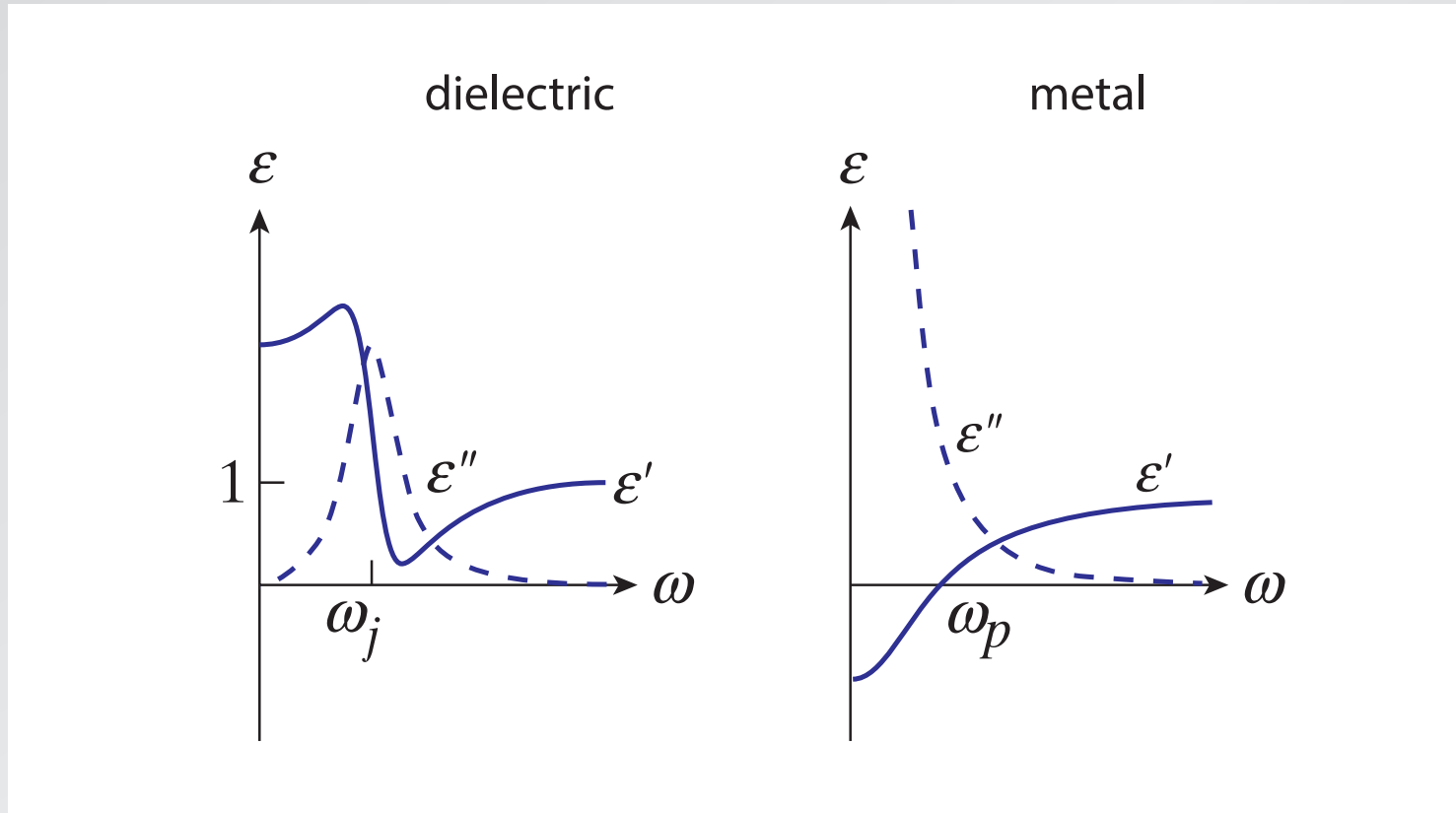

Lorentz and Drude models

for a strong (dielectric) resonance ϵ can become negative

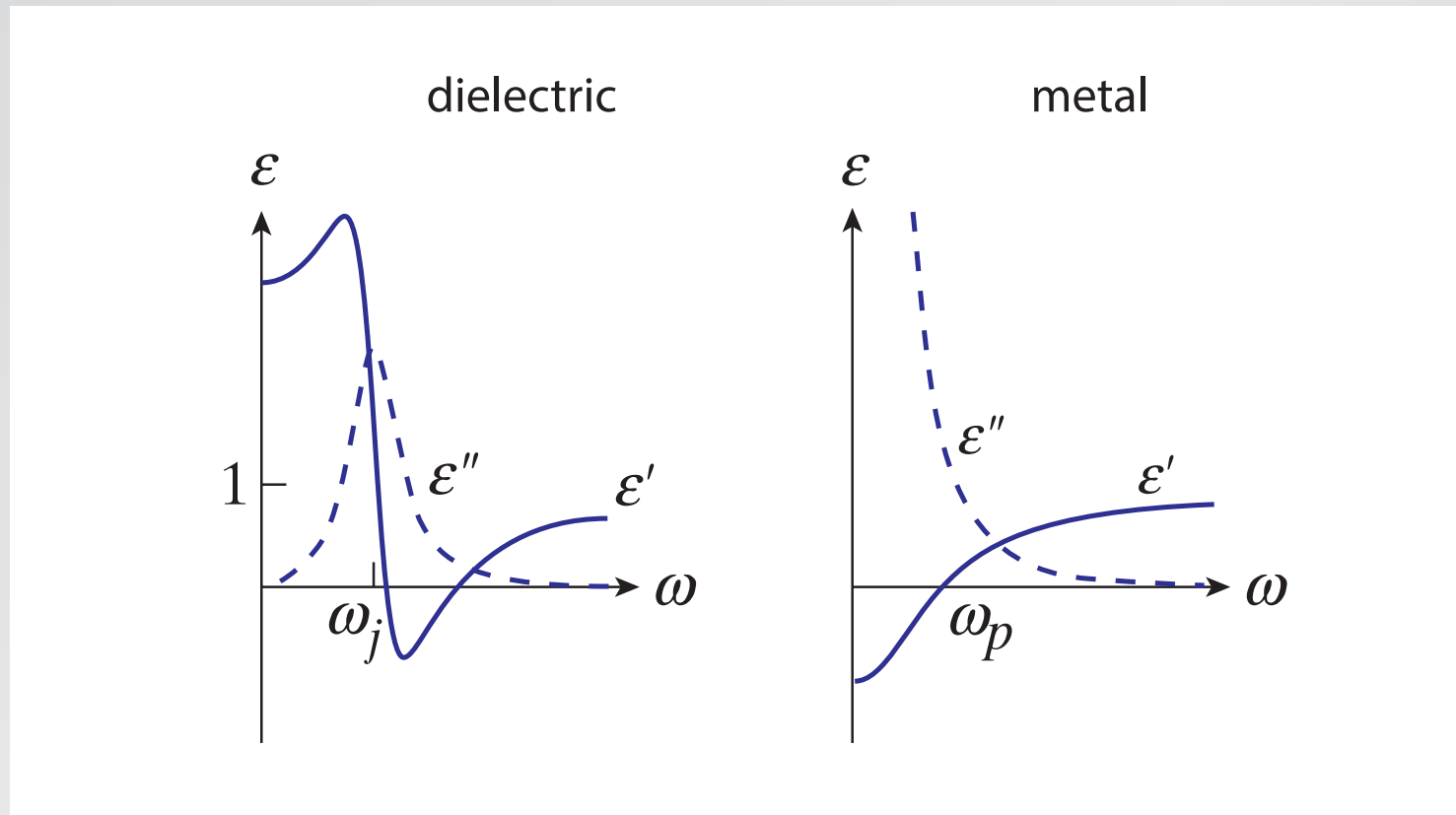

Lorentz and Drude models

valence electrons in dielectric then behave like a plasma

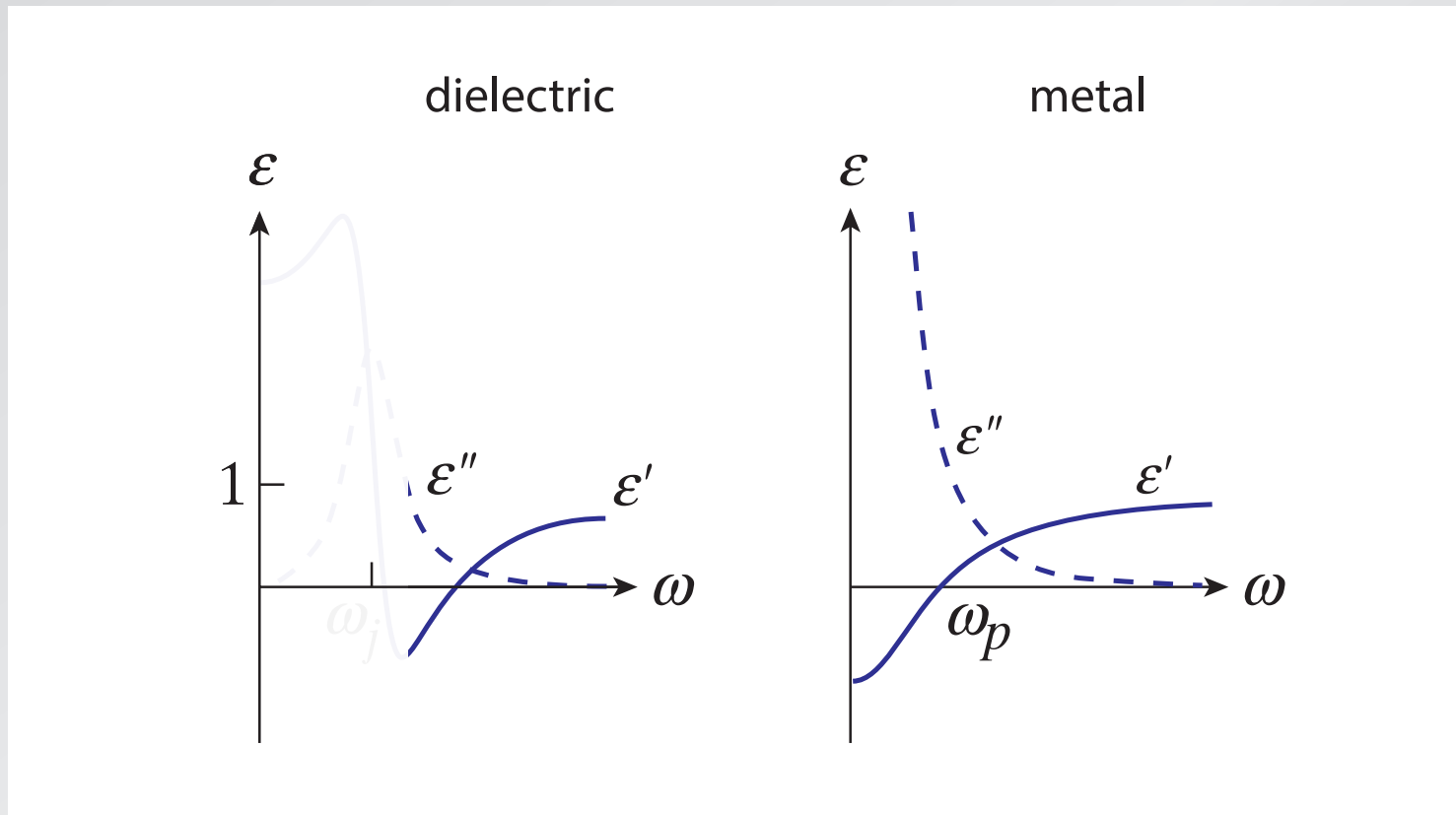

Lorentz and Drude models

with plasma frequency above the resonance

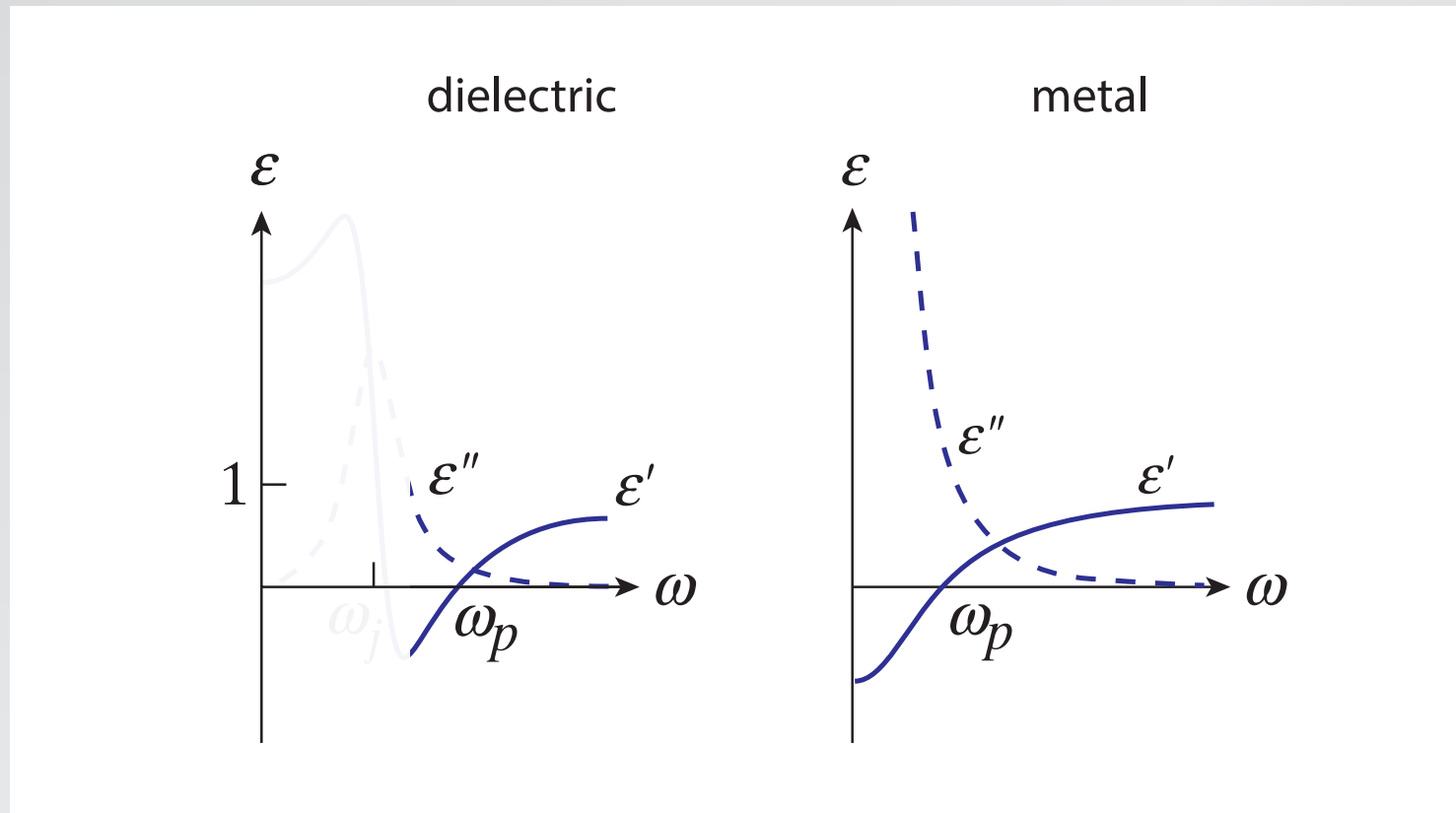

Lorentz and Drude models

(and far below the UV region)

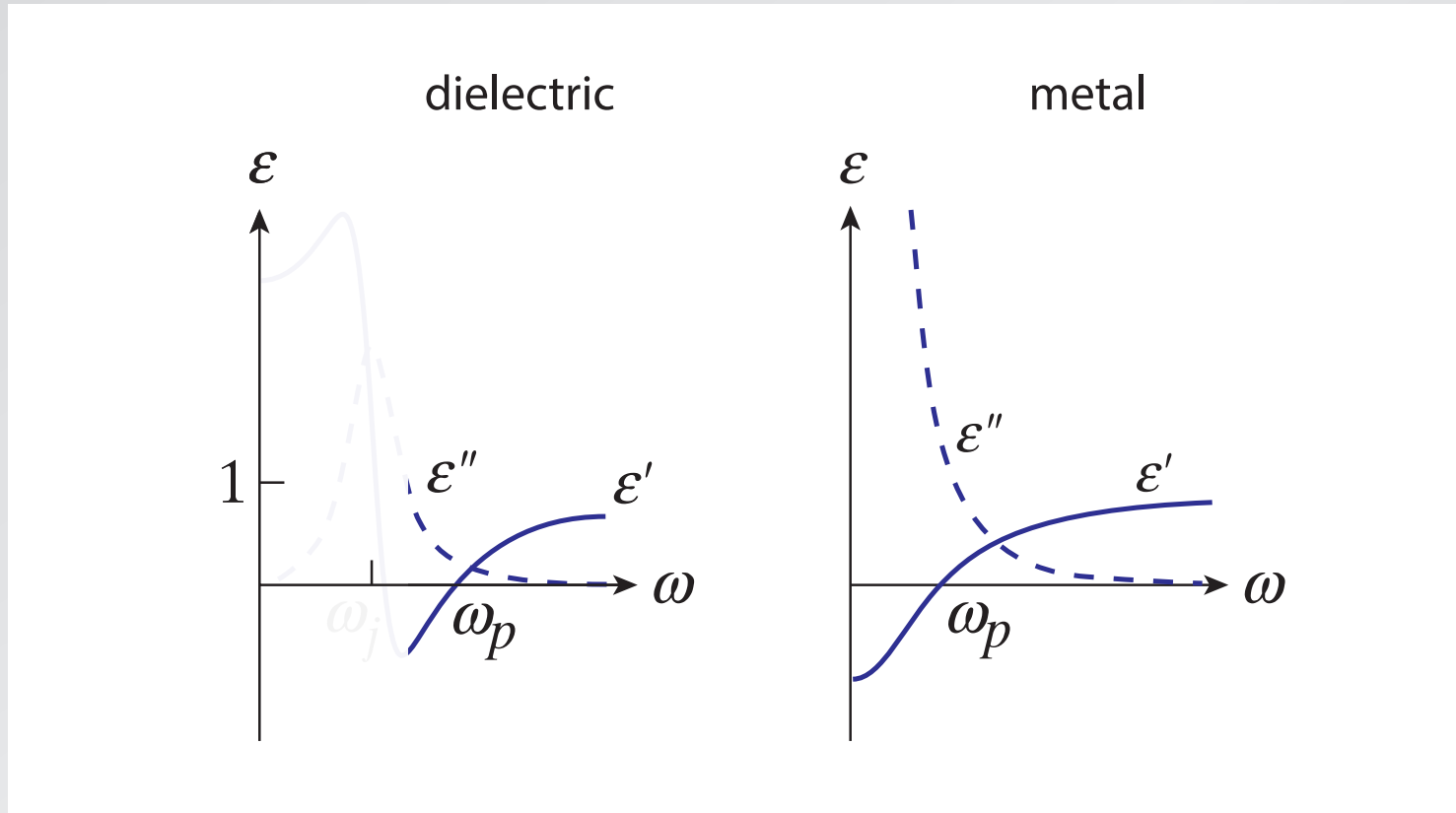

Index also determined by magnetic response

$$n = \sqrt{\epsilon \mu}$$

Index also determined by magnetic response

$$n = \sqrt{\epsilon \mu}$$

and magnetic response shows similar resonances

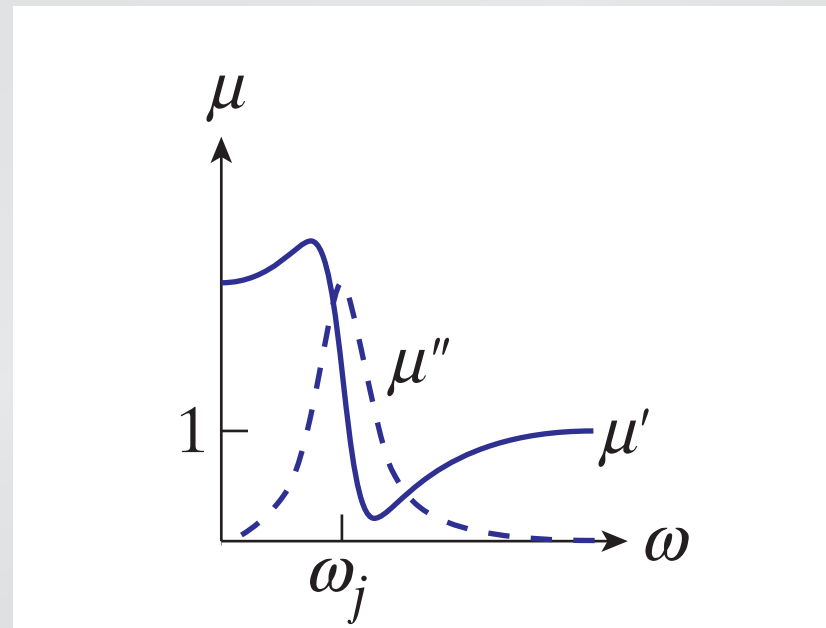

Magnetic response

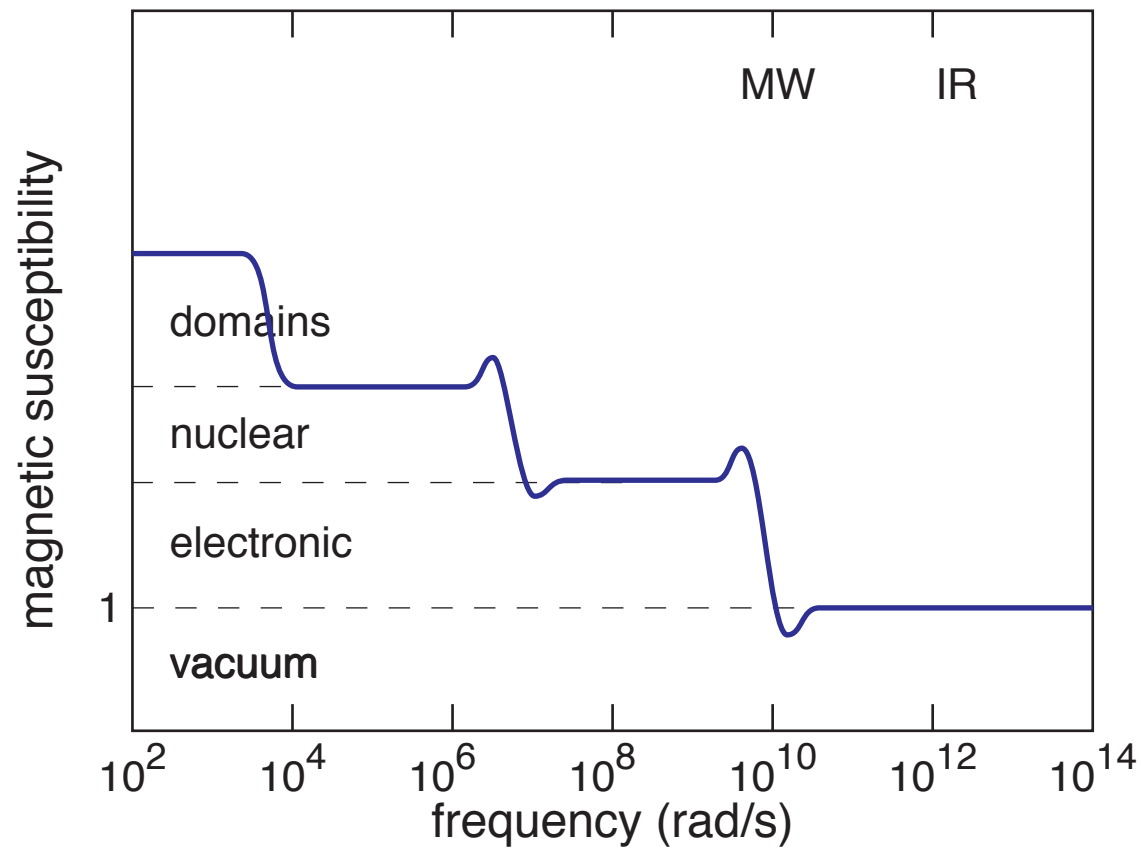

Magnetic response

but magnetic resonances occur below optical frequencies

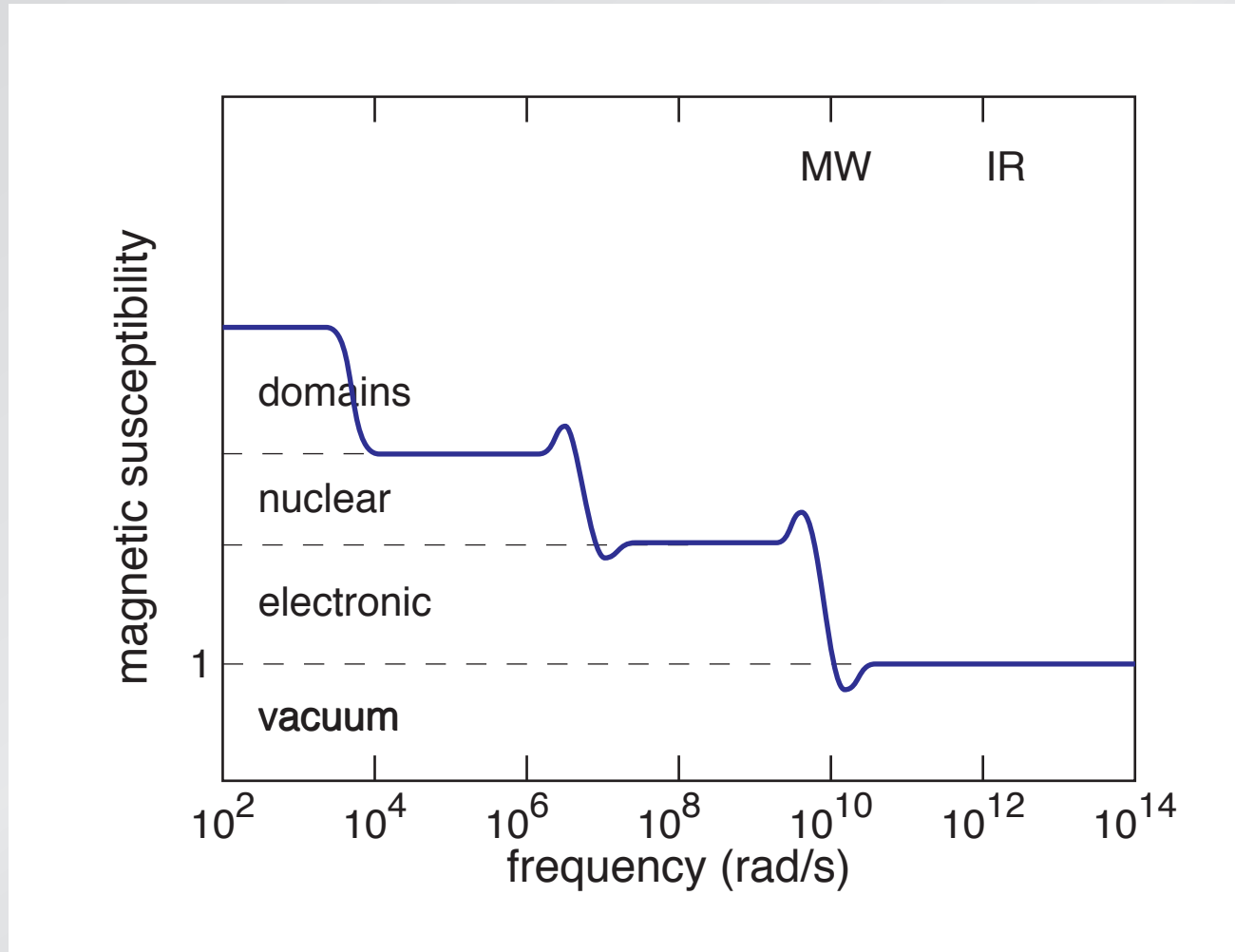

Magnetic response

so, in optical regime, $\mu \approx 1$

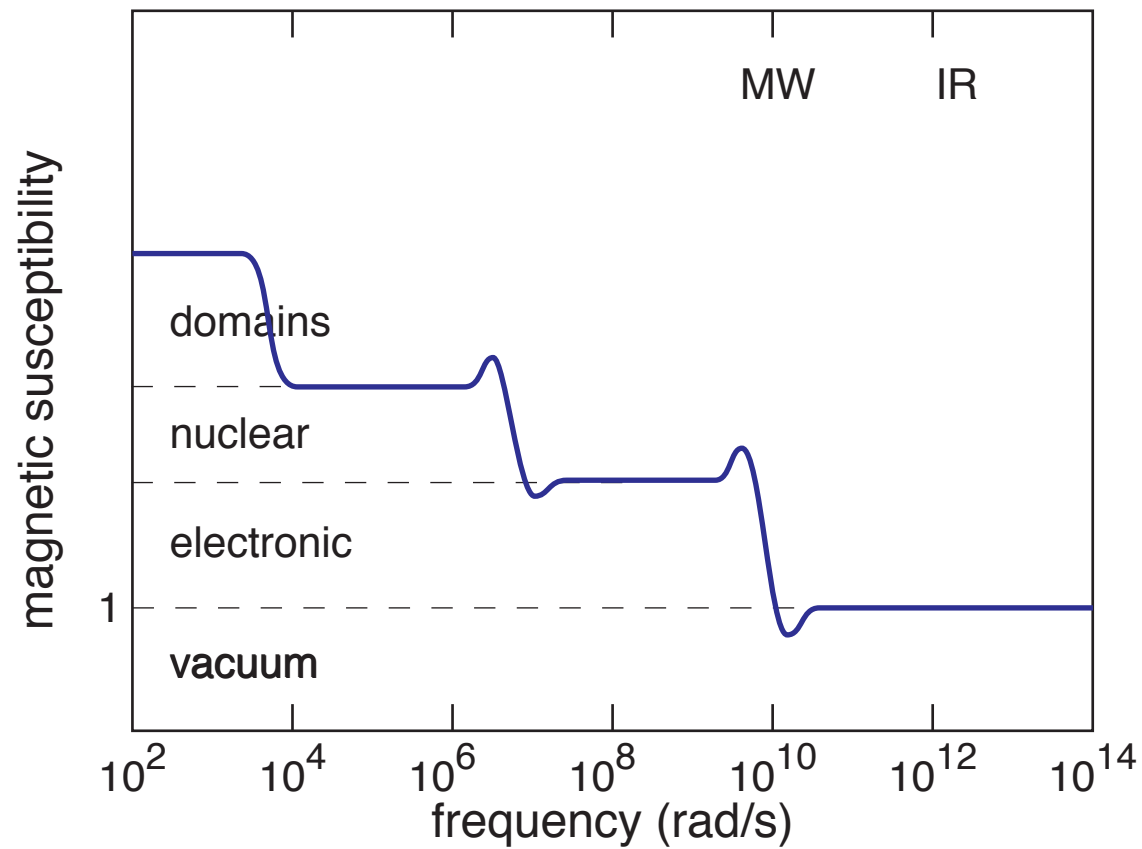

Index of refraction

$$n = \sqrt{\epsilon\mu}$$

Both ϵ and μ are complex and their real parts can be negative.

Index of refraction

$$n = \sqrt{\epsilon\mu}$$

Both ϵ and μ are complex and their real parts can be negative.

What happens when $\text{Re}\epsilon$ and/or $\text{Re}\mu$ is negative?

Write complex quantities as

$$\varepsilon = |\varepsilon| e^{i\theta} \quad \mu = |\mu| e^{i\phi}$$

Write complex quantities as

$$\varepsilon = |\varepsilon| e^{i\theta} \quad \mu = |\mu| e^{i\phi}$$

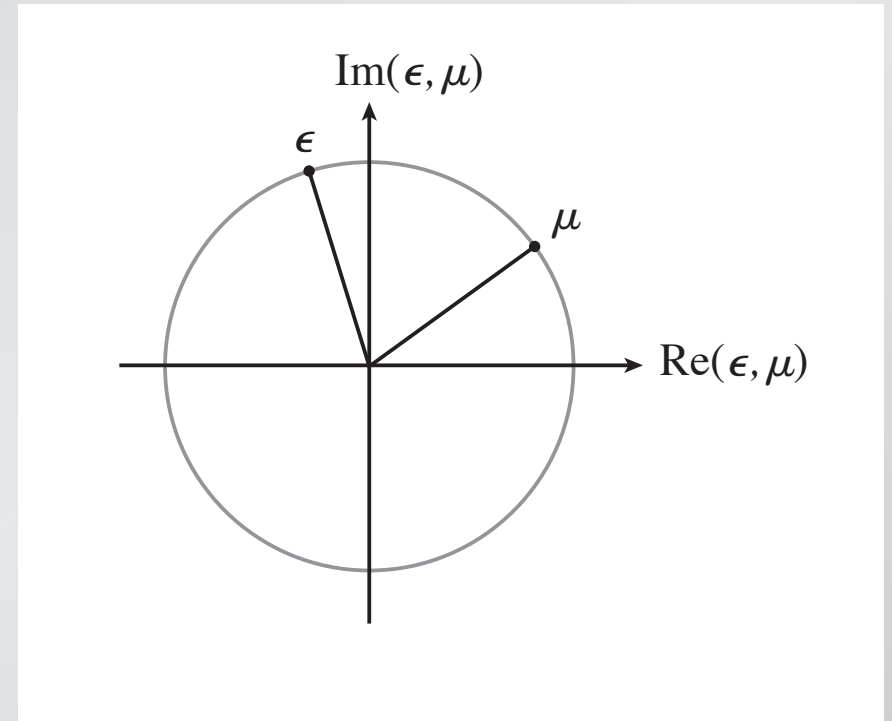

Write complex quantities as

$$\varepsilon = |\varepsilon| e^{i\theta} \quad \mu = |\mu| e^{i\phi}$$

Index

$$n = \sqrt{|\varepsilon||\mu|} e^{i\frac{\theta+\phi}{2}}$$

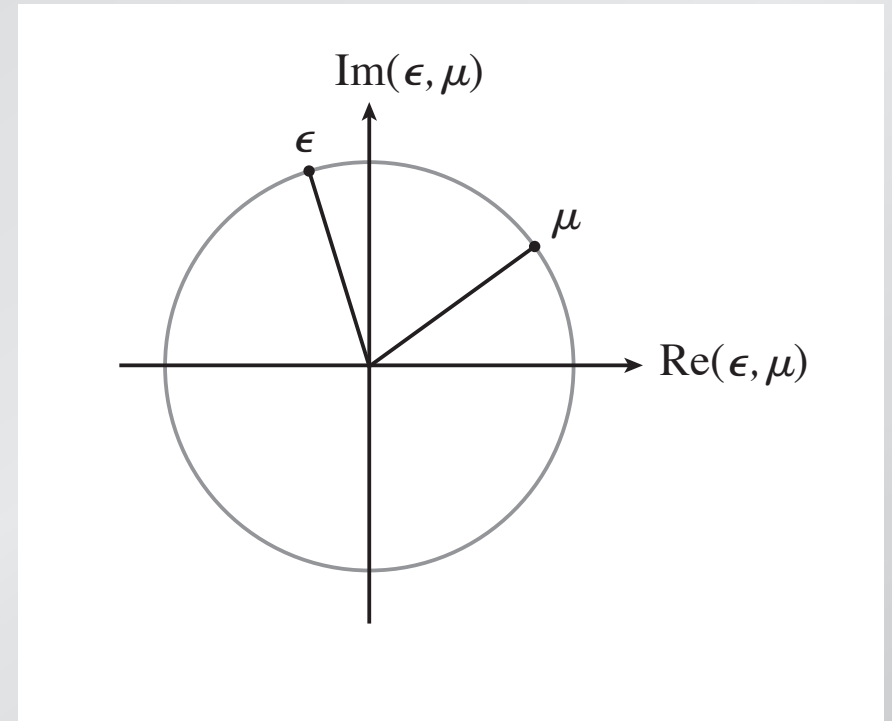

Write complex quantities as

$$\varepsilon = |\varepsilon| e^{i\theta} \quad \mu = |\mu| e^{i\phi}$$

Index

$$n = \sqrt{|\varepsilon||\mu|} e^{i\frac{\theta+\phi}{2}}$$

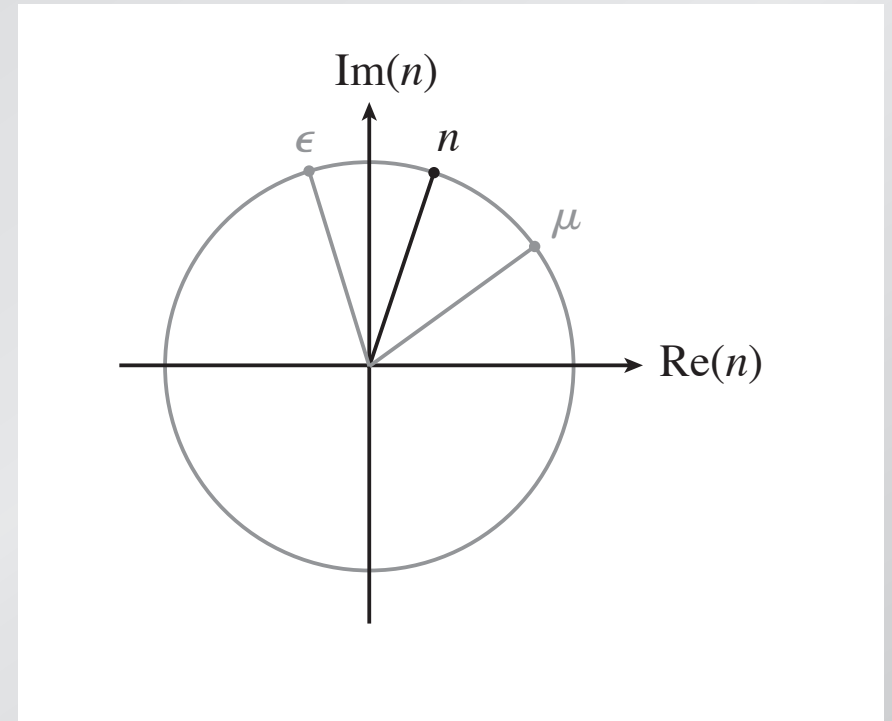

Write complex quantities as

$$\varepsilon = |\varepsilon| e^{i\theta} \quad \mu = |\mu| e^{i\phi}$$

Index

$$n = \sqrt{|\varepsilon||\mu|} e^{i\frac{\theta+\phi}{2}}$$

Q: Is this only possible value?

1. yes
2. no, there's one more
3. there are many more
4. it depends

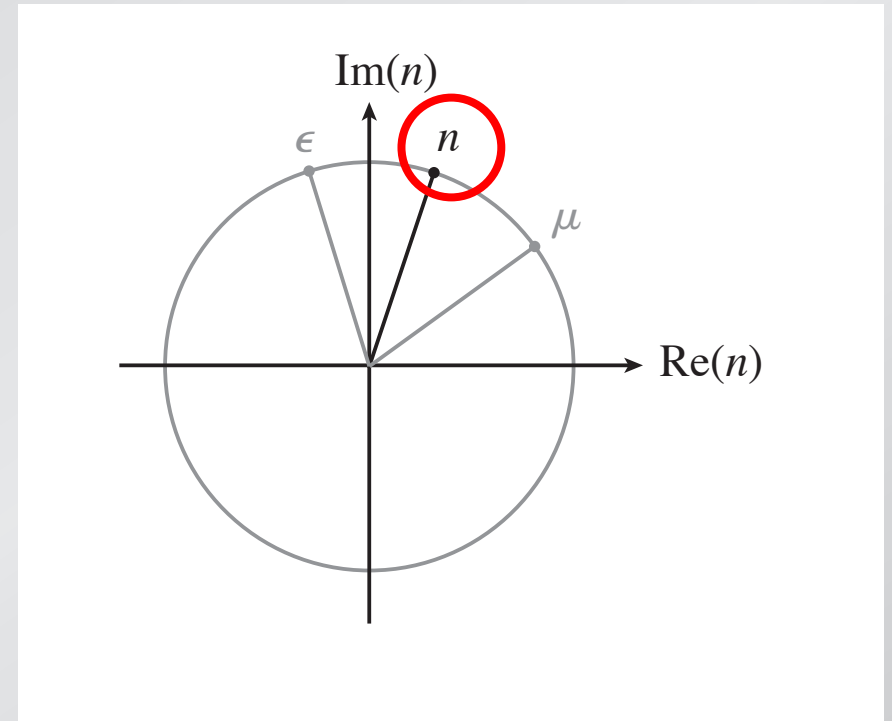

There *is* another root...

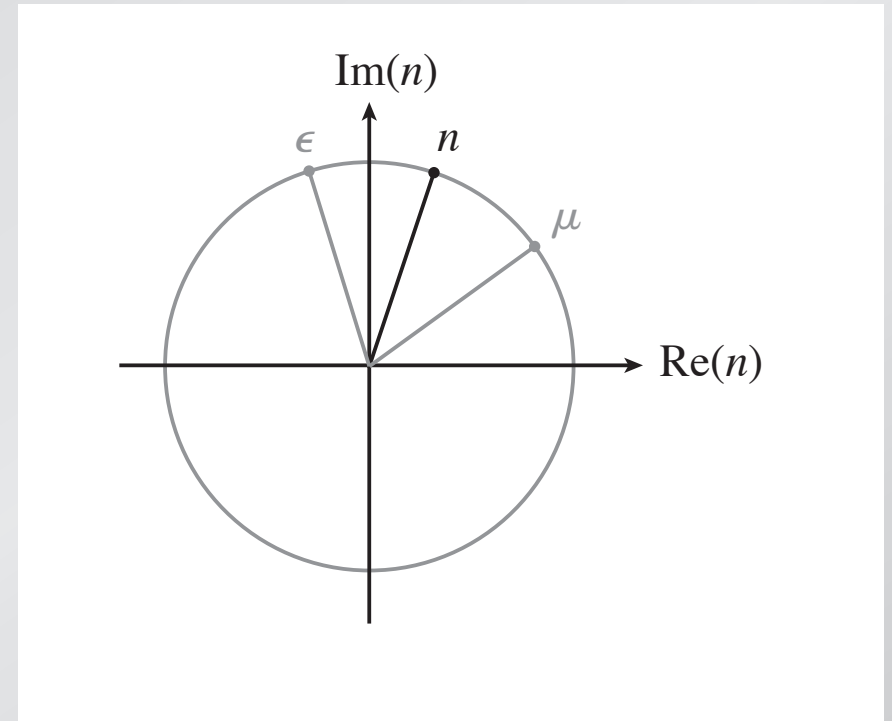

There *is* another root...

Can add 2π to exponent

$$e^{+i(\theta+\phi)} = e^{+i[\theta+\phi+2\pi]}$$

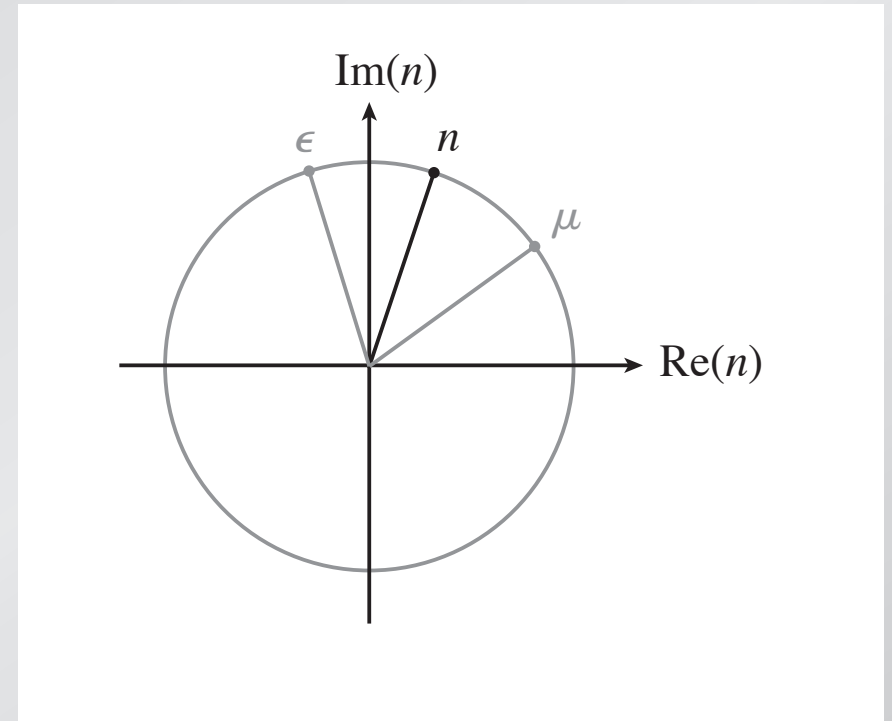

There *is* another root...

Can add 2π to exponent

$$e^{+i(\theta+\phi)} = e^{+i[\theta+\phi+2\pi]}$$

and so

$$n = \sqrt{|\varepsilon||\mu|} e^{i\left[\frac{\theta+\phi}{2}+\pi\right]}$$

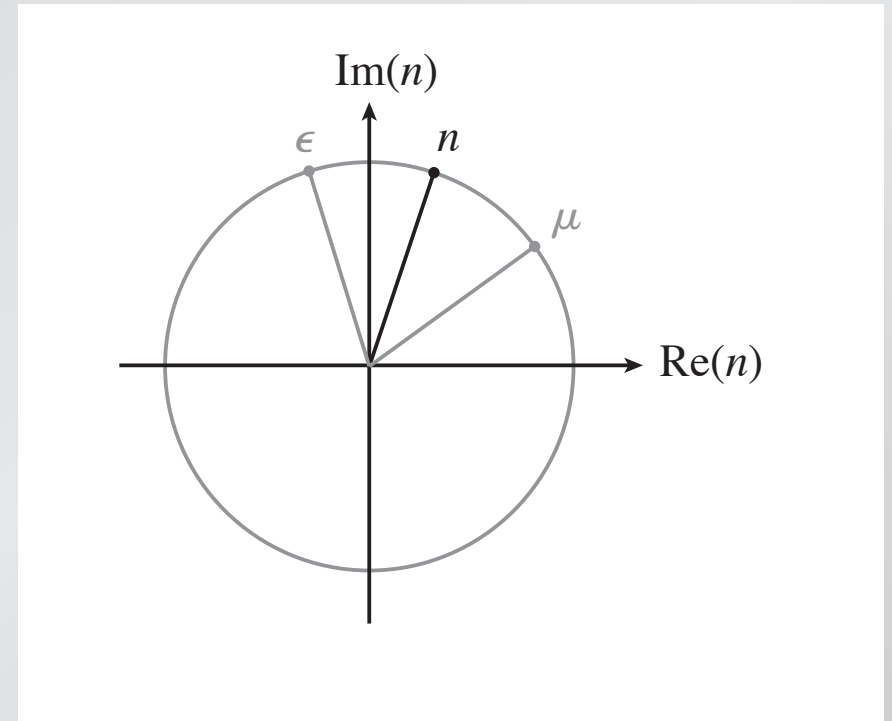

There *is* another root...

Can add 2π to exponent

$$e^{+i(\theta+\phi)} = e^{+i[\theta+\phi+2\pi]}$$

and so

$$n = \sqrt{|\varepsilon||\mu|} e^{i\left[\frac{\theta+\phi}{2}+\pi\right]}$$

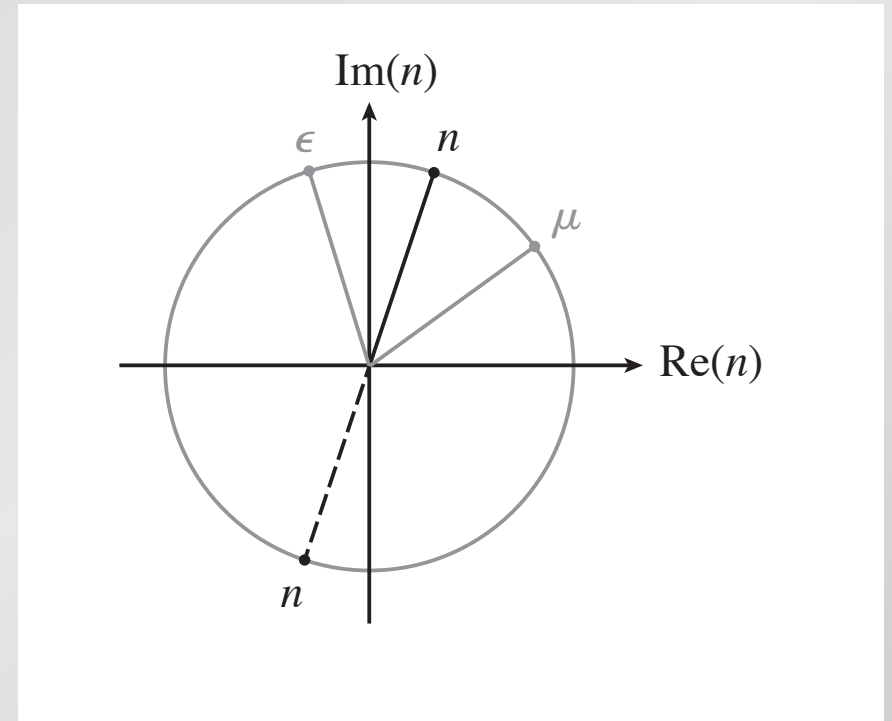

There *is* another root...

Can add 2π to exponent

$$e^{+i(\theta+\phi)} = e^{+i[\theta+\phi+2\pi]}$$

and so

$$n = \sqrt{|\epsilon||\mu|} e^{i\left[\frac{\theta+\phi}{2}+\pi\right]}$$

but...

$$k = \frac{2\pi n}{\lambda_o} = \frac{2\pi(n' + in'')}{\lambda_o} = k' + ik''$$

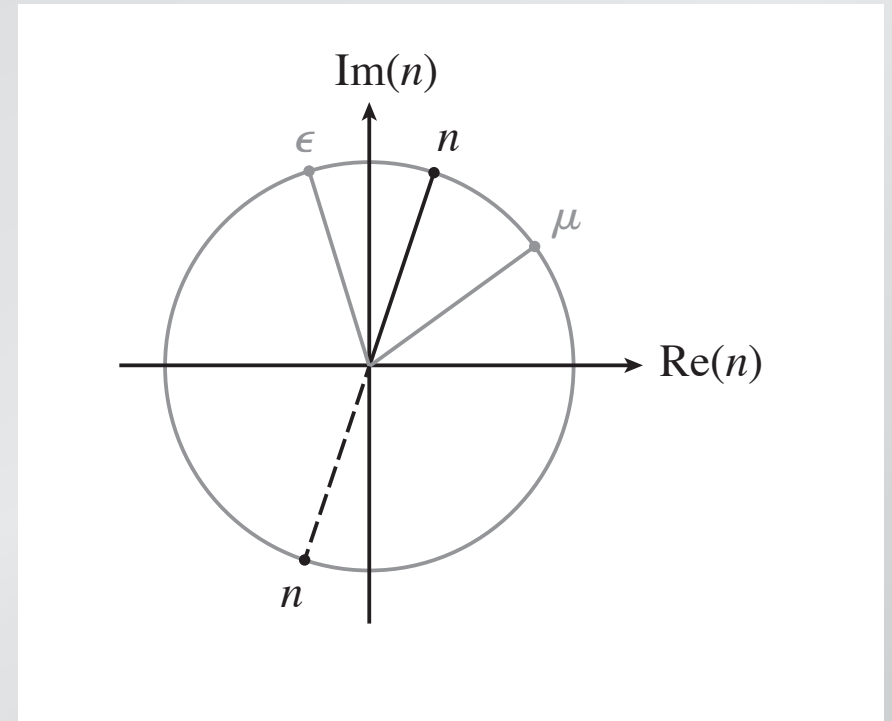

There *is* another root...

Can add 2π to exponent

$$e^{+i(\theta+\phi)} = e^{+i[\theta+\phi+2\pi]}$$

and so

$$n = \sqrt{|\epsilon||\mu|} e^{i\left[\frac{\theta+\phi}{2}+\pi\right]}$$

but...

$$k = \frac{2\pi n}{\lambda_o} = \frac{2\pi(n' + in'')}{\lambda_o} = k' + ik''$$

and

$$E = E_o e^{i(kx-\omega t)} = E_o e^{-k''x} e^{i(k'x-\omega t)}$$

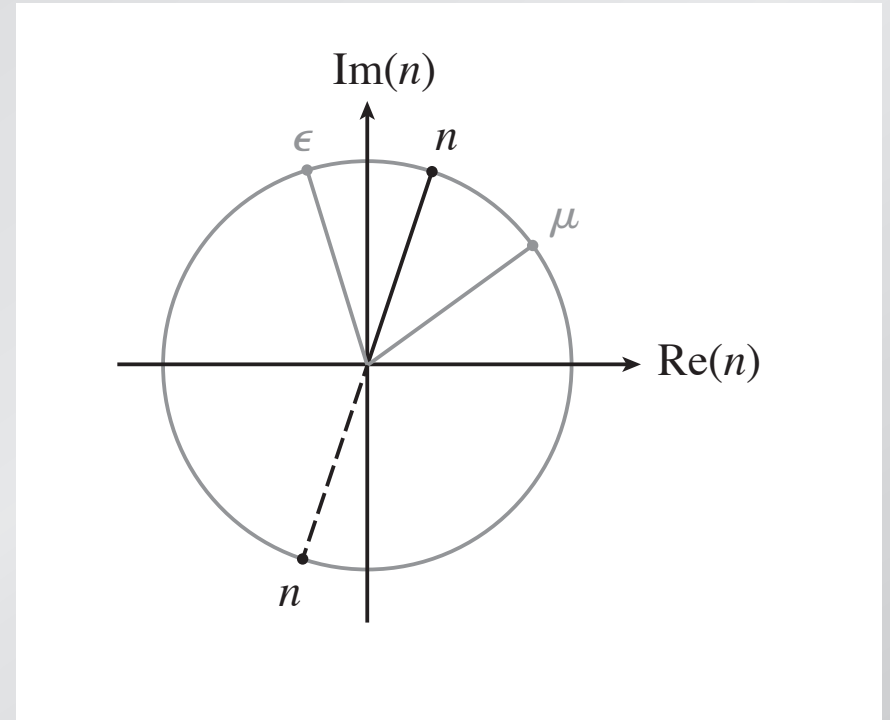

There *is* another root...

Can add 2π to exponent

$$e^{+i(\theta+\phi)} = e^{+i[\theta+\phi+2\pi]}$$

and so

$$n = \sqrt{|\epsilon||\mu|} e^{i\left[\frac{\theta+\phi}{2}+\pi\right]}$$

but...

$$k = \frac{2\pi n}{\lambda_o} = \frac{2\pi(n' + in'')}{\lambda_o} = k' + ik''$$

and

$$E = E_o e^{i(kx-\omega t)} = E_o e^{-k''x} e^{i(k'x-\omega t)}$$

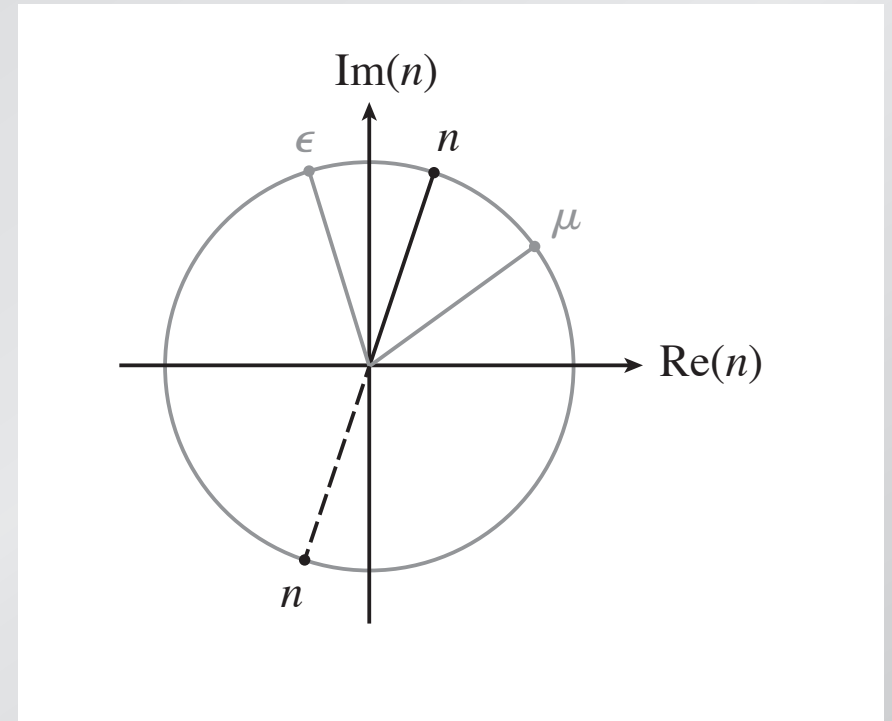

There *is* another root...

Can add 2π to exponent

$$e^{+i(\theta+\phi)} = e^{+i[\theta+\phi+2\pi]}$$

and so

$$n = \sqrt{|\epsilon||\mu|} e^{i\left[\frac{\theta+\phi}{2}+\pi\right]}$$

but...

$$k = \frac{2\pi n}{\lambda_o} = \frac{2\pi(n' + in'')}{\lambda_o} = k' + ik''$$

and

$$E = E_o e^{i(kx-\omega t)} = E_o e^{-k''x} e^{i(k'x-\omega t)}$$

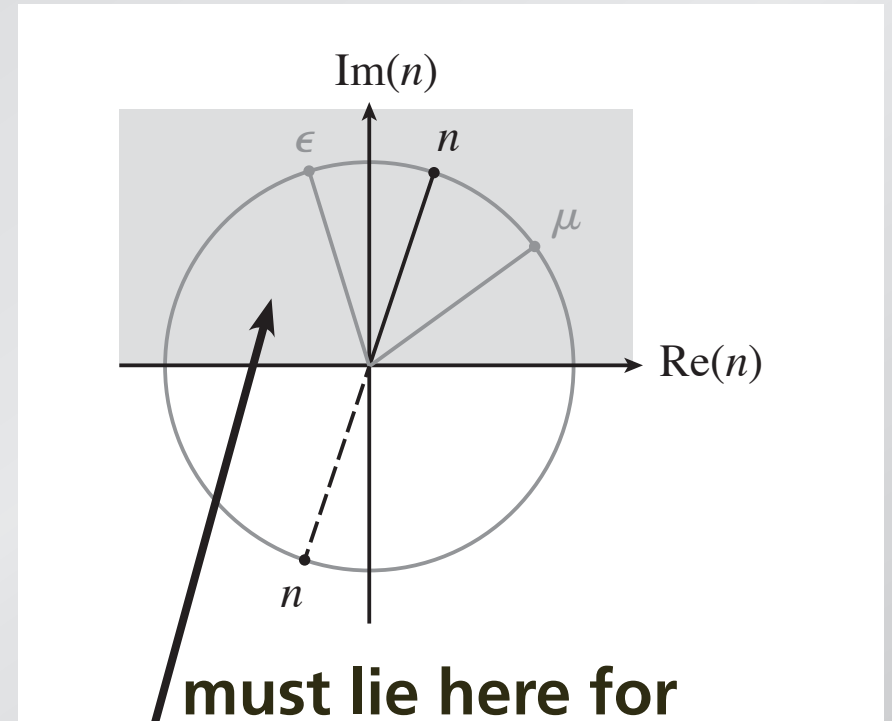

must lie here for
passive material

There *is* another root...

Can add 2π to exponent

$$e^{+i(\theta+\phi)} = e^{+i[\theta+\phi+2\pi]}$$

and so

$$n = \sqrt{|\epsilon||\mu|} e^{i\left[\frac{\theta+\phi}{2}+\pi\right]}$$

but...

$$k = \frac{2\pi n}{\lambda_o} = \frac{2\pi(n' + in'')}{\lambda_o} = k' + ik''$$

and

$$E = E_o e^{i(kx-\omega t)} = E_o e^{-k''x} e^{i(k'x-\omega t)}$$

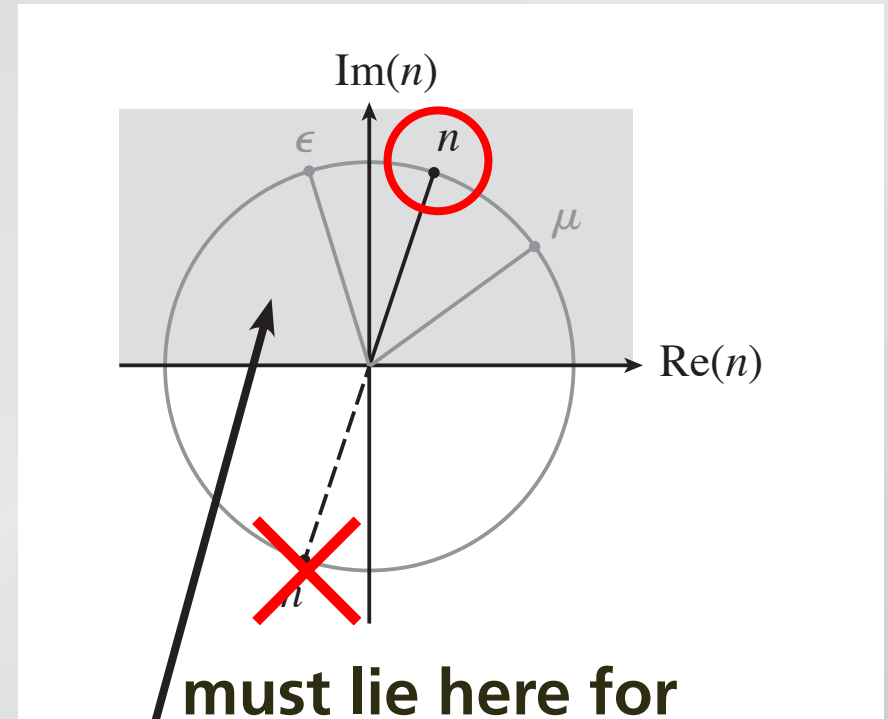

must lie here for
passive material

Q: Is this the only possible value?

1. yes ✓

2. no, there's one more

3. there are many more

4. it depends

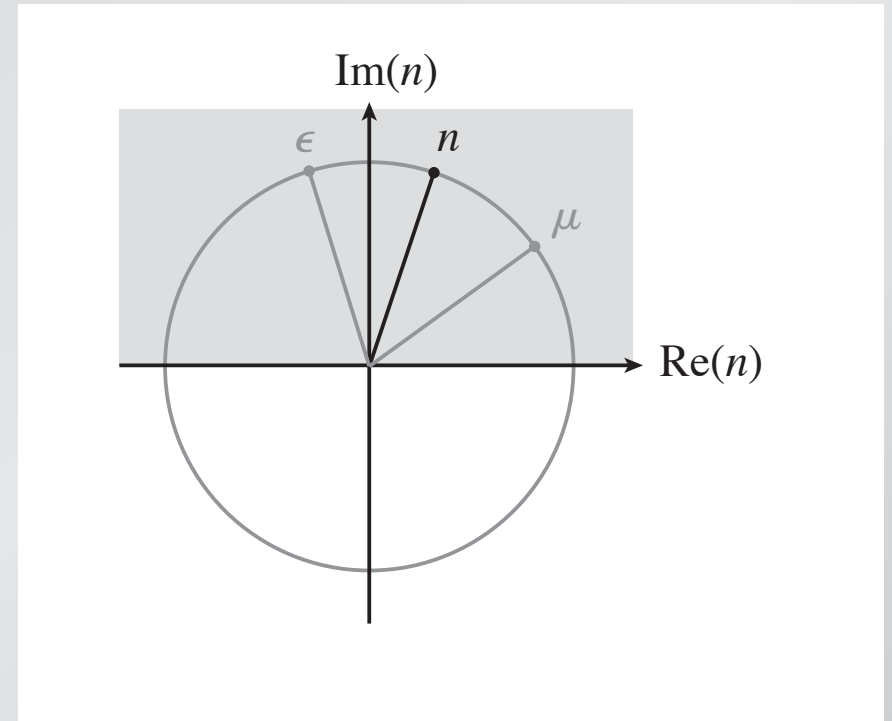

Q: Is this the only possible value?

1. yes ✓

2. no, there's one more ✓

3. there are many more

4. it depends

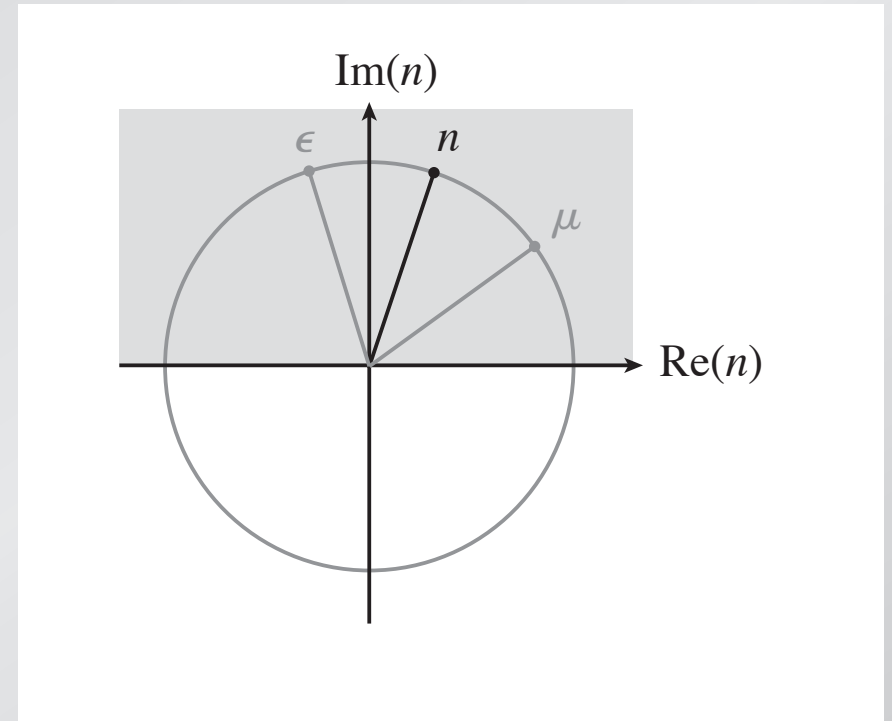

Q: Is this the only possible value?

1. yes ✓
2. no, there's one more ✓
3. there are many more
4. it depends ✓

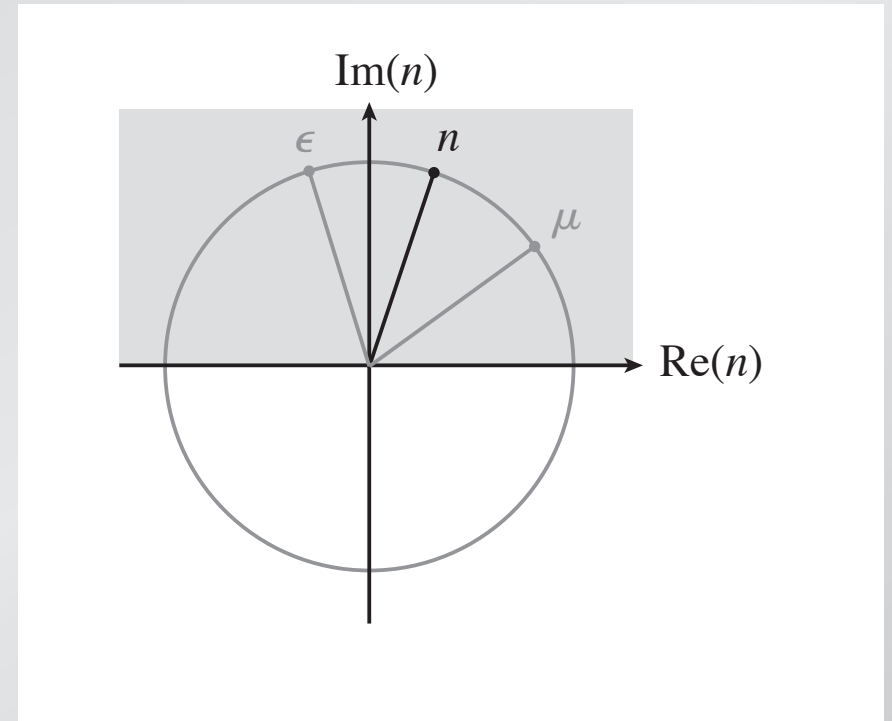

Q: Is this the only possible value?

1. yes ✓
2. no, there's one more ✓
3. there are many more ✓
4. it depends ✓

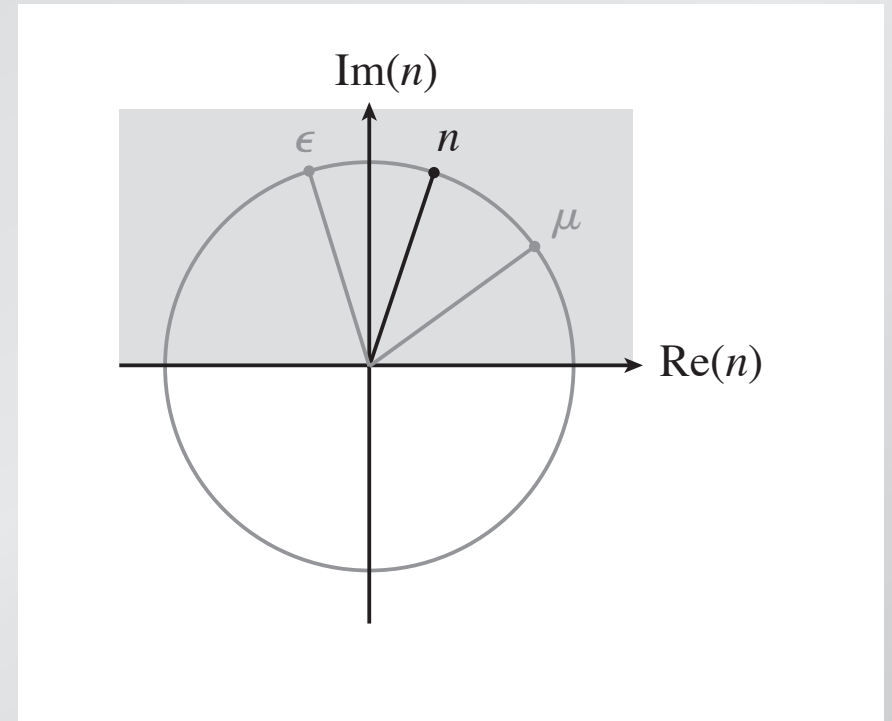

To find n (passive materials):

1. Draw line that bisects ϵ and μ
2. Choose upper branch

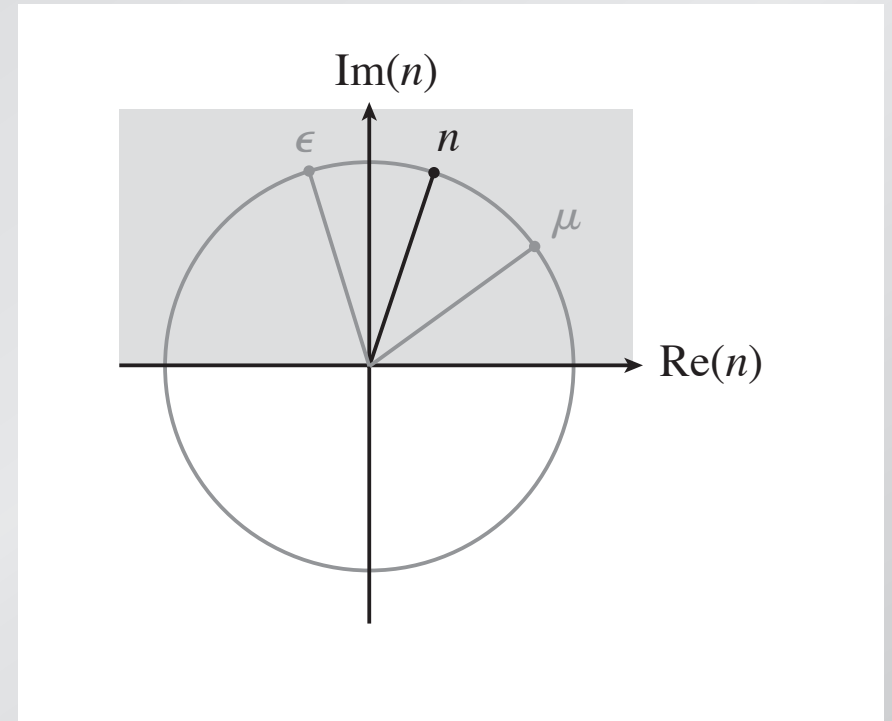

What happens when $\text{Re}\epsilon$ and/or $\text{Re}\mu$ is negative?

For certain values of ϵ and μ
we can get a *negative* $\text{Re}(n)$!

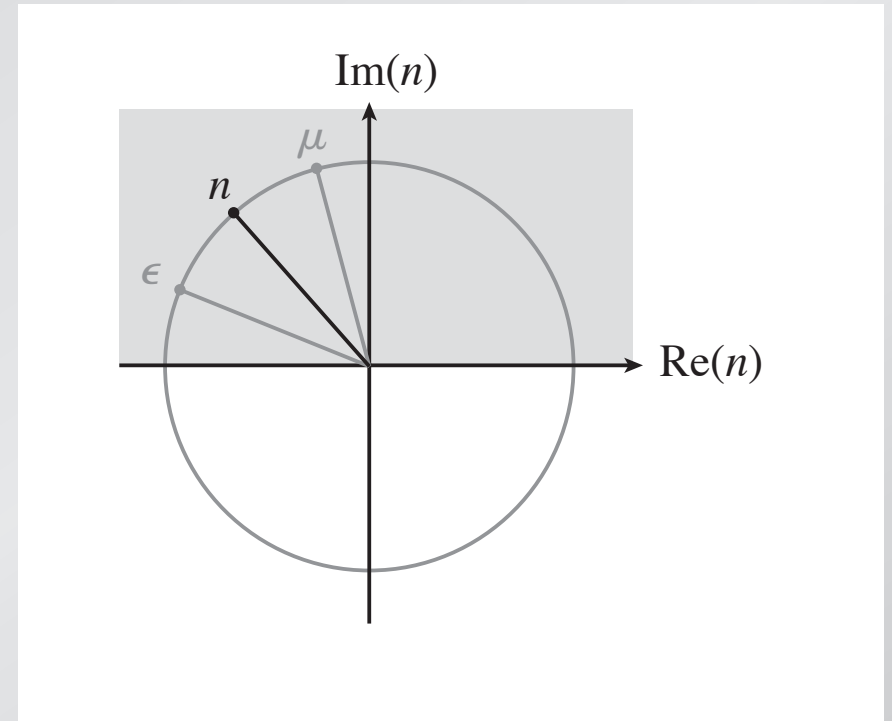

Q: Must both $\text{Re}\epsilon < 0$ and $\text{Re}\mu < 0$

to get a negative $\text{Re}(n)$?

1. yes

2. no

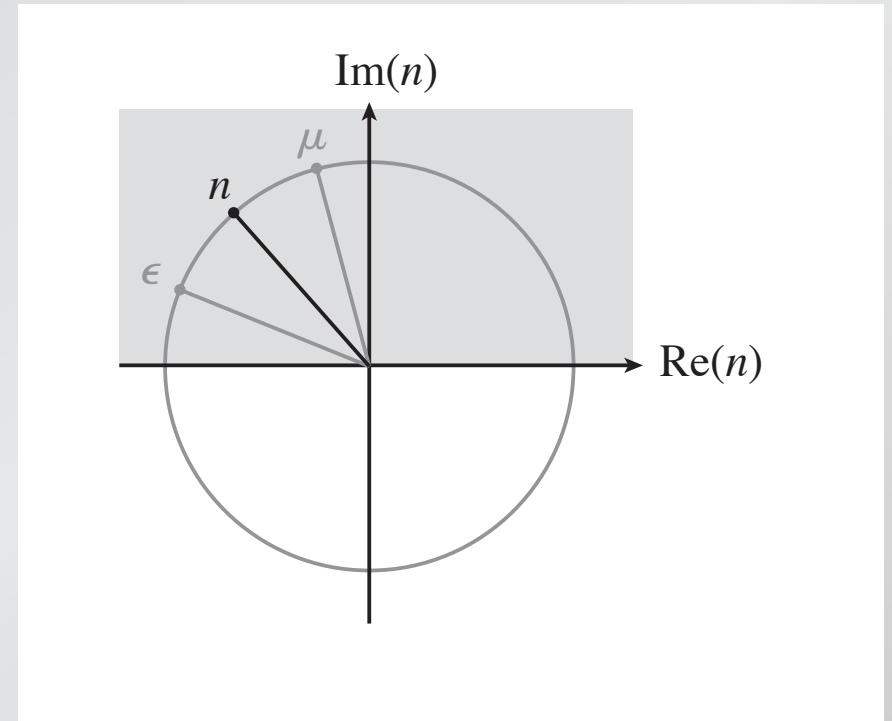

Q: Must both $\text{Re}\epsilon < 0$ and $\text{Re}\mu < 0$

to get a negative $\text{Re}(n)$?

1. yes

2. no ✓

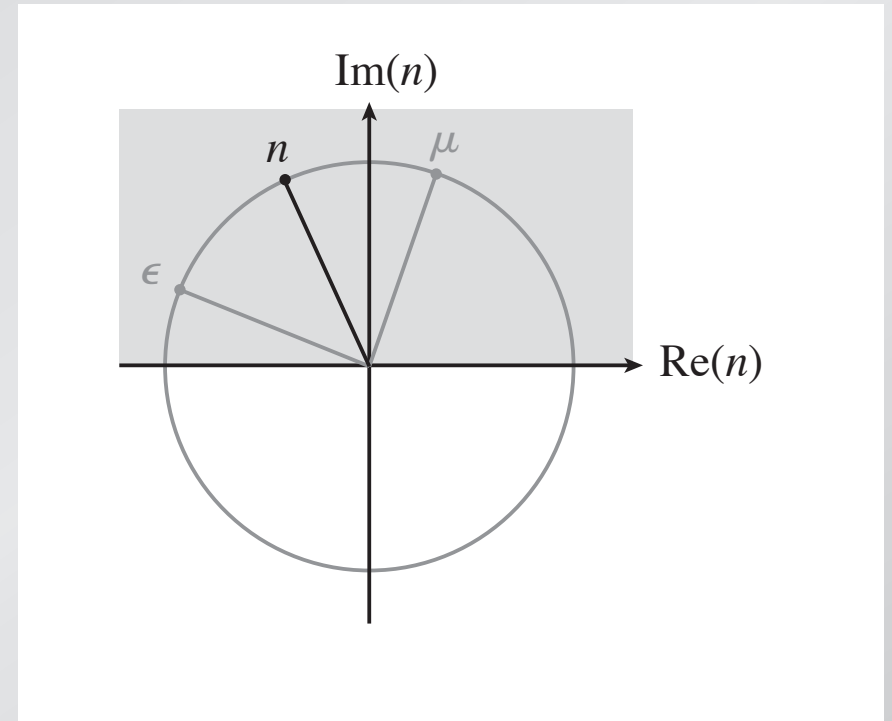

However, need magnetic response
to achieve $\text{Re}(n) \leq 0$!

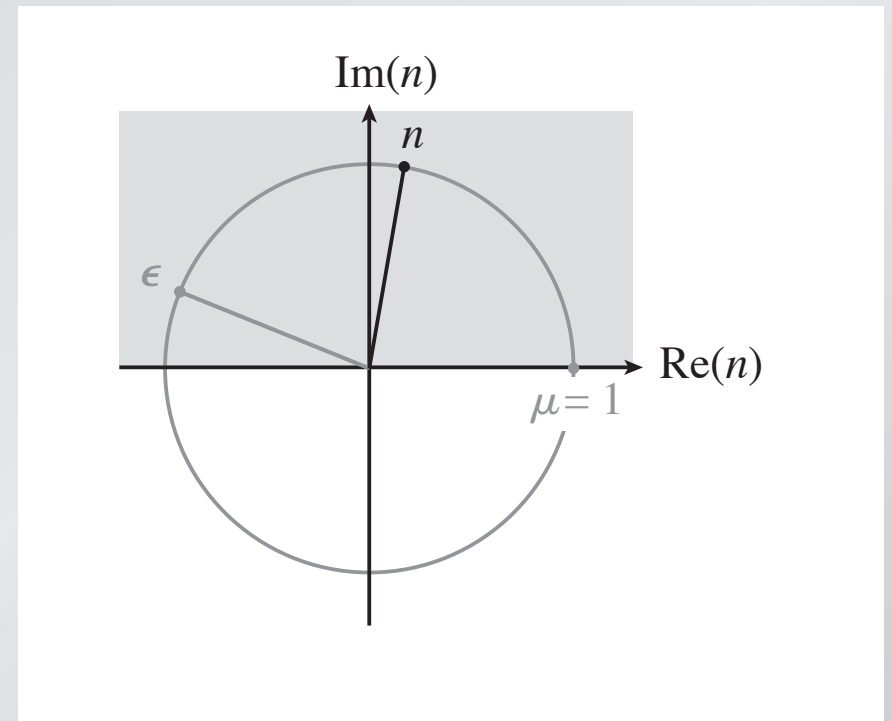

What happens when $\operatorname{Re}(n) < 0$?

What happens when $\text{Re}(n) < 0$?

Remember

$$k = \frac{2\pi n}{\lambda_o} = \frac{2\pi(n' + in'')}{\lambda_o} = k' + ik''$$

$$E = E_o e^{i(kx - \omega t)} = E_o e^{-k''x} e^{i(k'x - \omega t)}$$

What happens when $\text{Re}(n) < 0$?

Remember

$$k = \frac{2\pi n}{\lambda_o} = \frac{2\pi(n' + in'')}{\lambda_o} = k' + ik''$$

$$E = E_o e^{i(kx - \omega t)} = E_o e^{-k''x} e^{i(k'x - \omega t)}$$

When $\text{Re}(n) < 0$, $k' < 0$, and so phase velocity reversed!

What happens when $\text{Re}(n) < 0$?

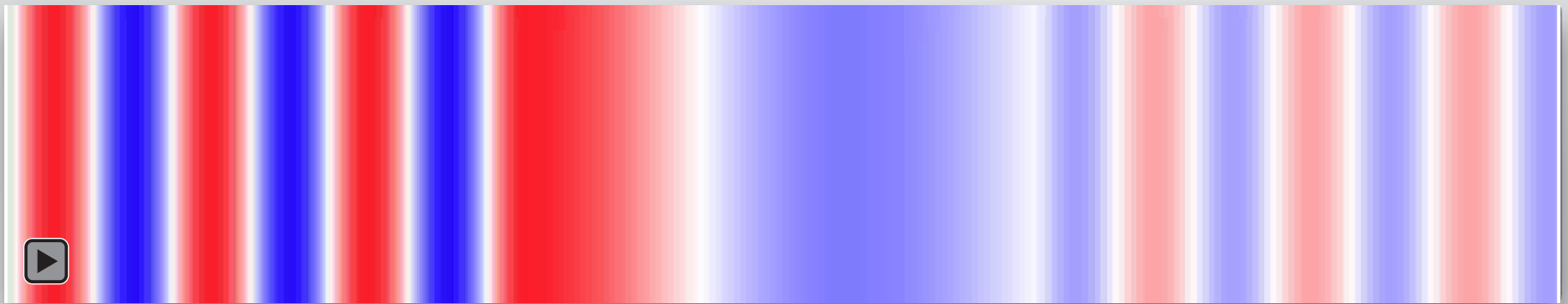

When $\text{Re}(n) < 0$, $k' < 0$, and so phase velocity reversed!

What happens when $\text{Re}(n) < 0$?

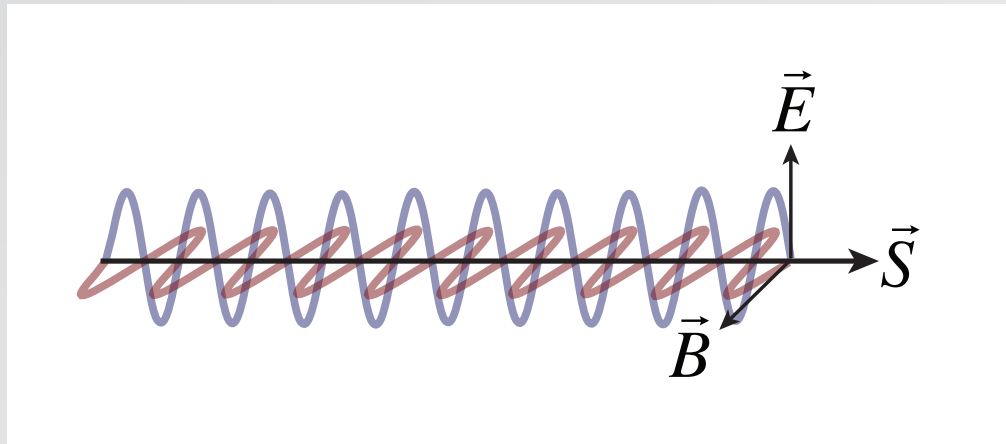

When $\text{Re}(n) < 0$, $k' < 0$, and so phase velocity reversed!

What happens when $\text{Re}(n) < 0$?

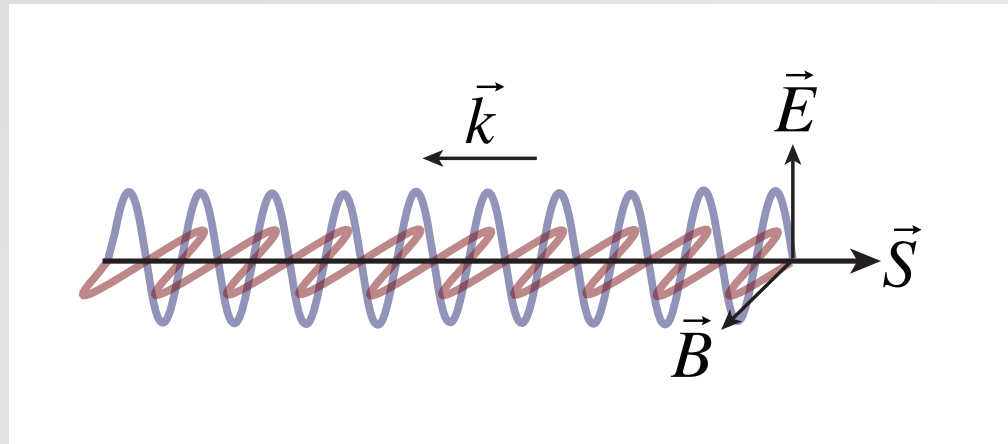

When $\text{Re}(n) < 0$, $k' < 0$, and so phase velocity reversed!

What about causality?



What about causality?

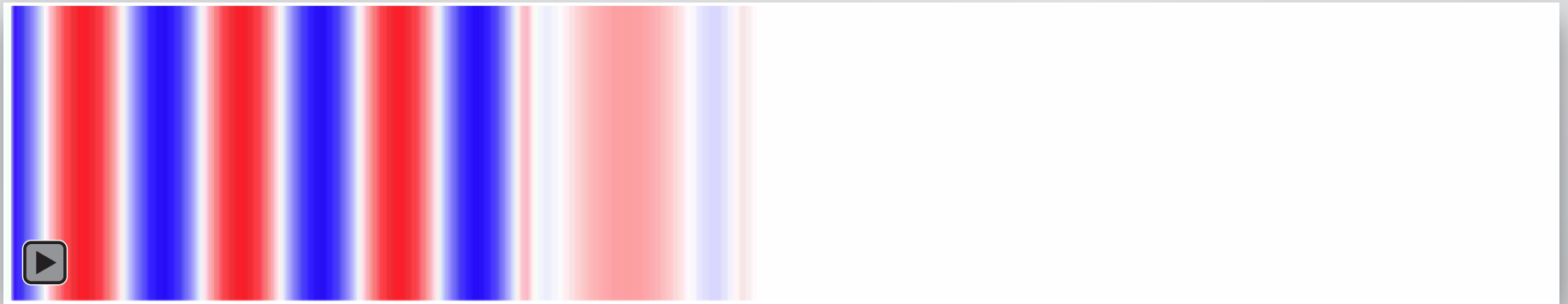

What about causality?

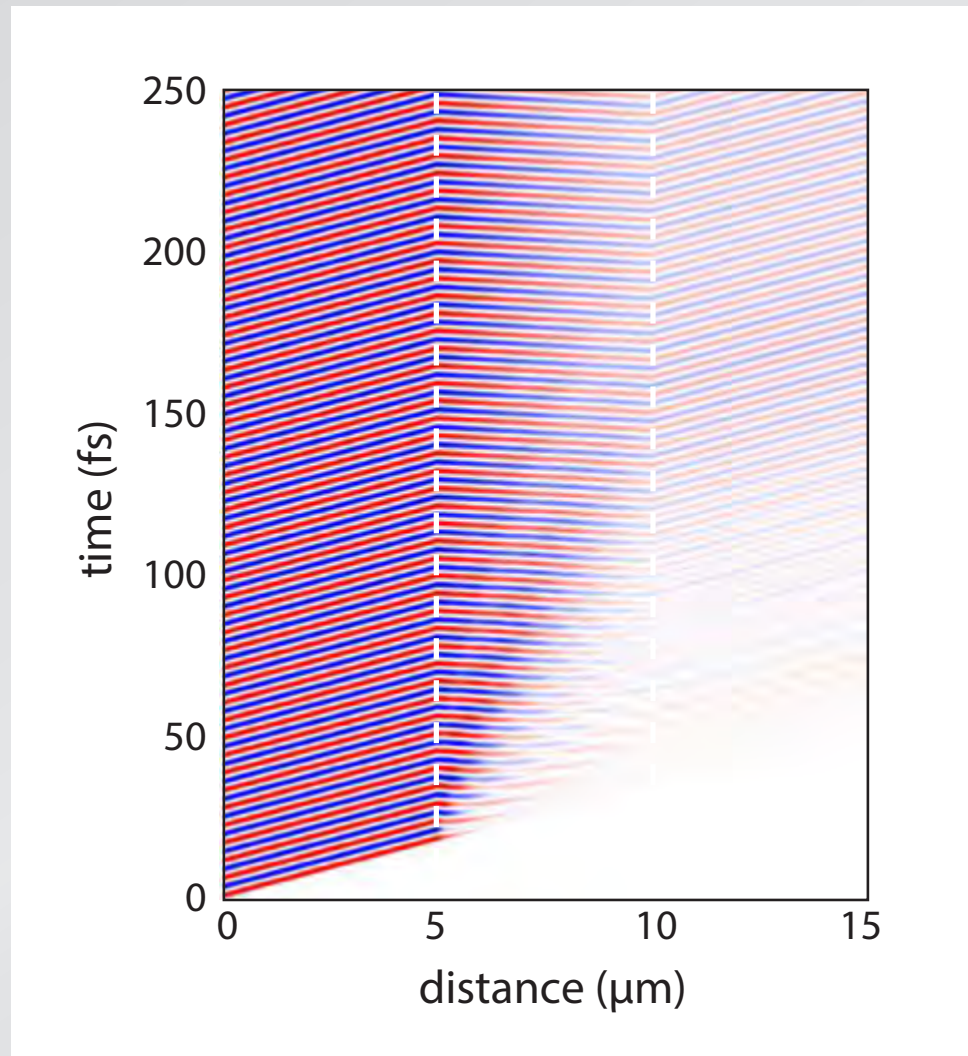

What about causality?

speed of light c

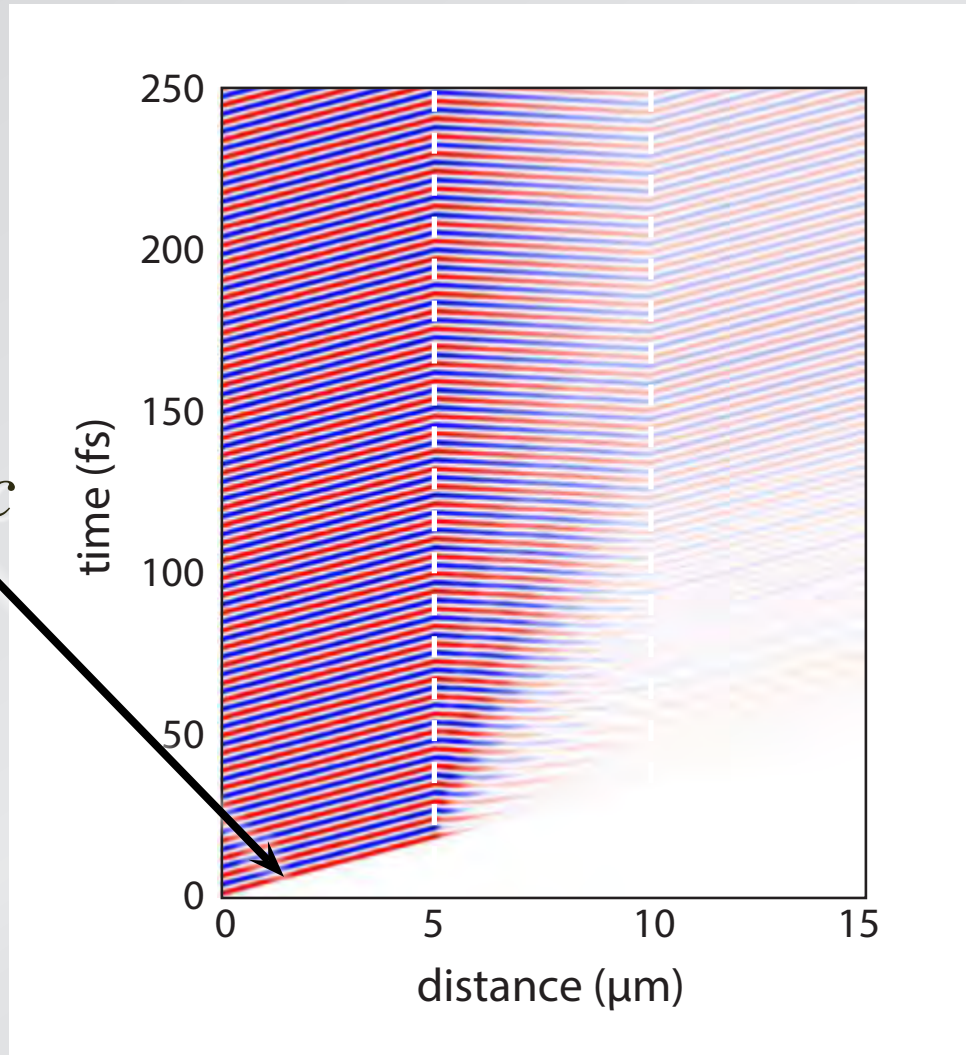
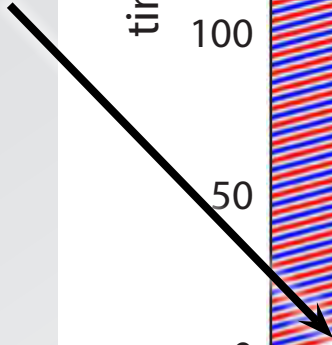

What about causality?

speed of light c

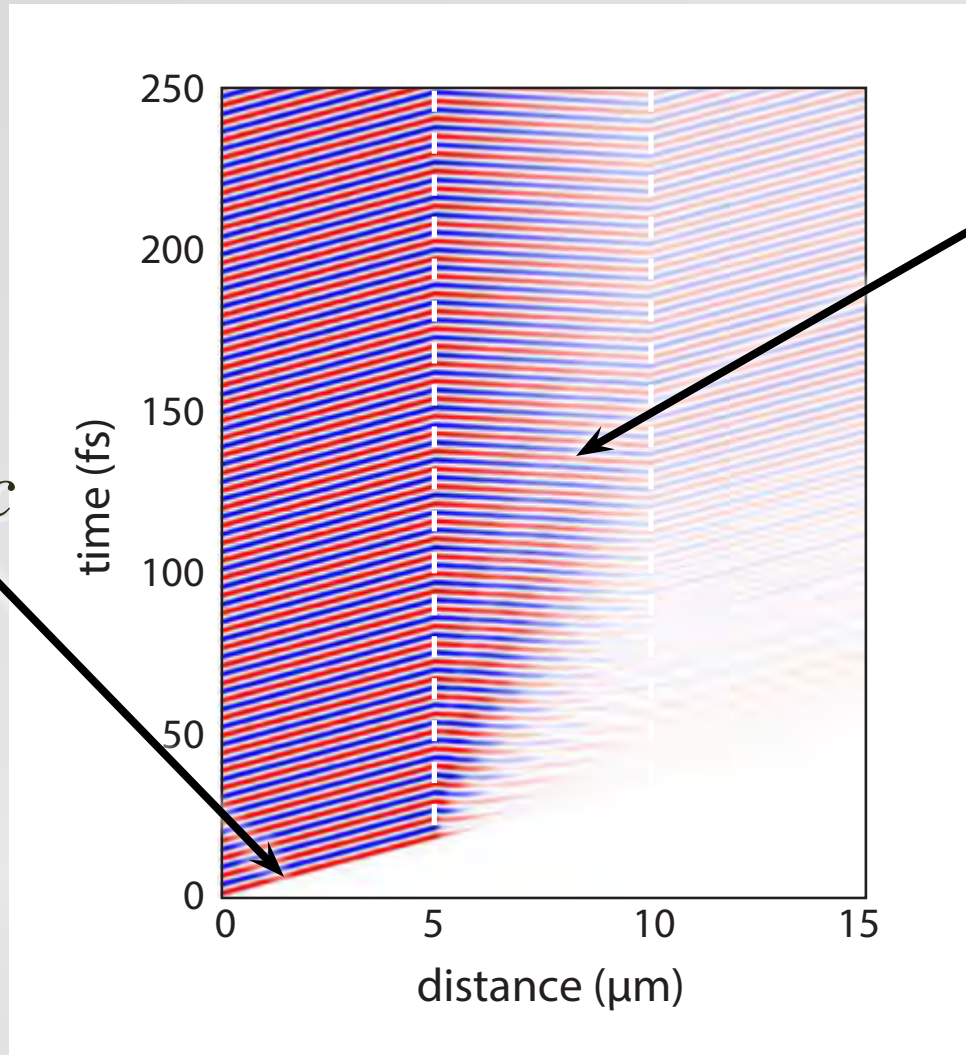

reverse phase propagation

What about causality?

group velocity

$$v_g < c$$

speed of light c

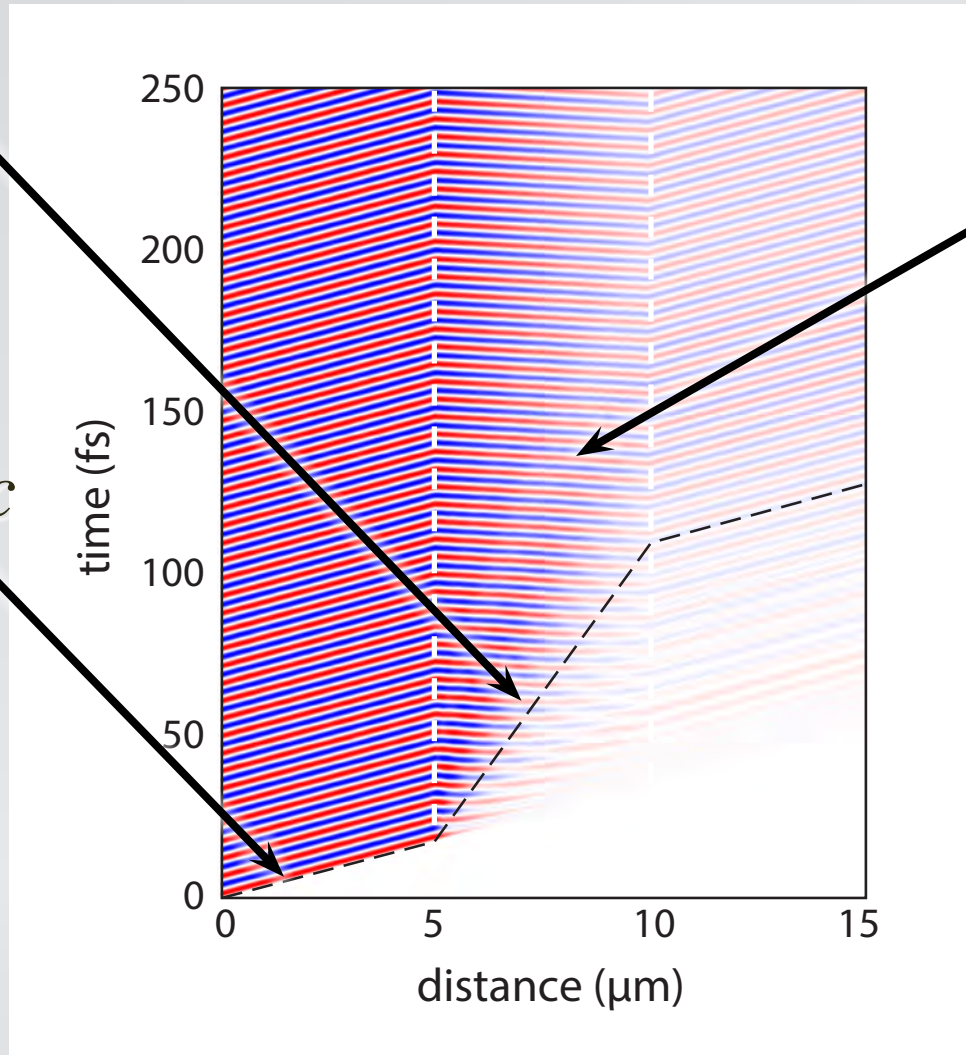

reverse phase propagation

What about causality?

group velocity

$$v_g < c$$

speed of light c

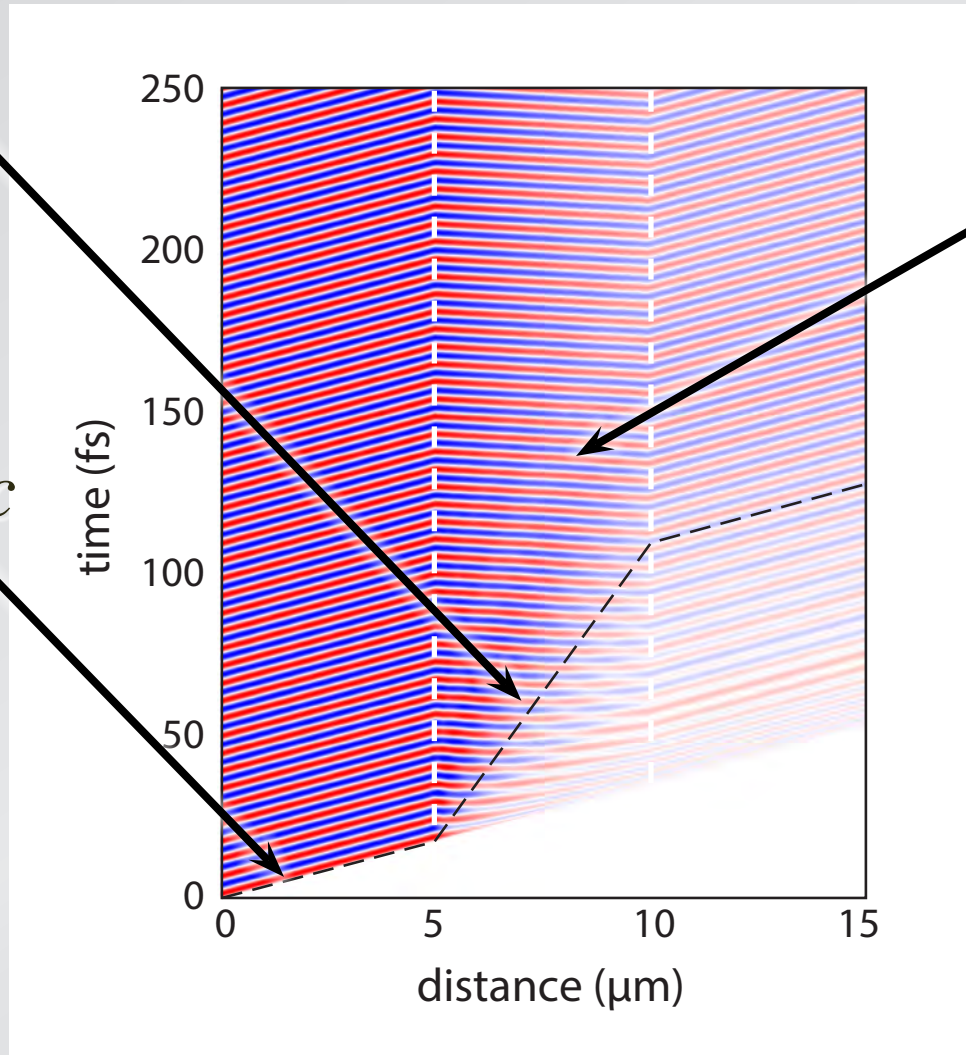

reverse phase propagation

What about causality?

group velocity

$$v_g < c$$

speed of light c

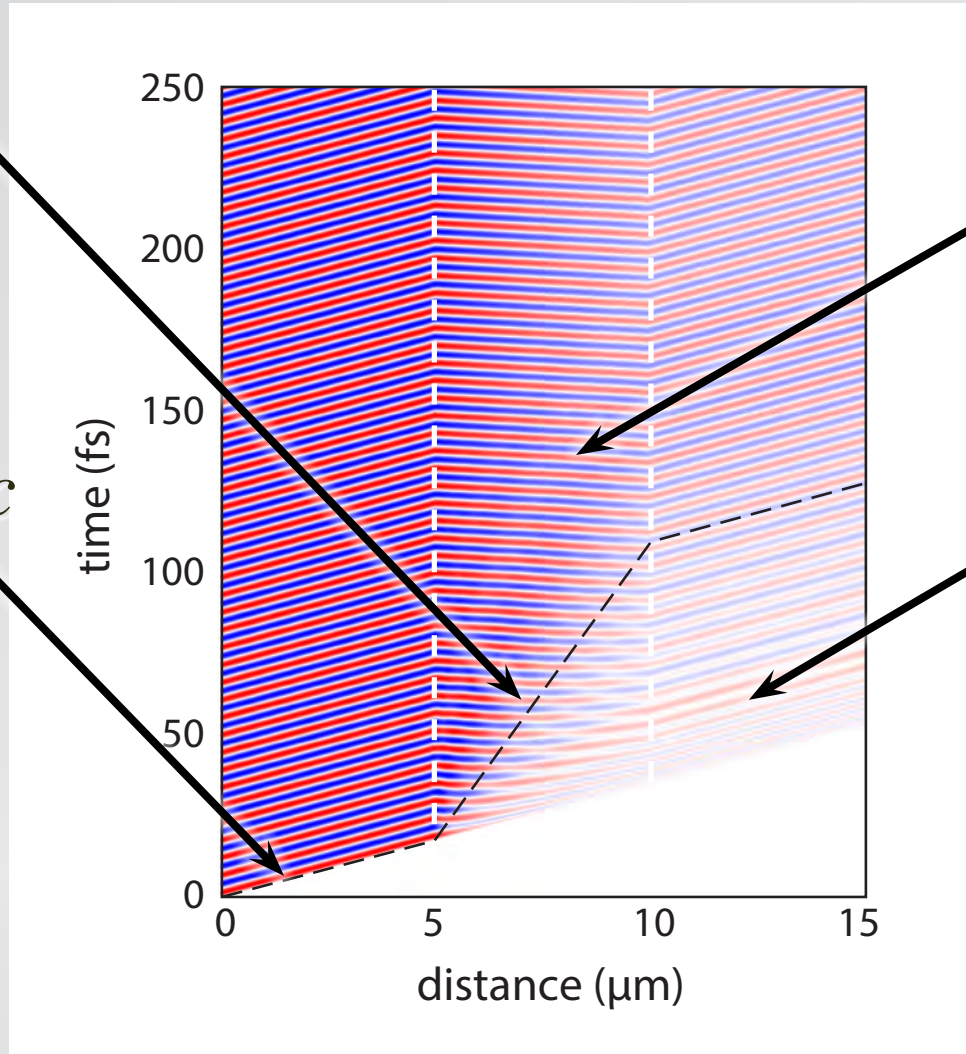

reverse phase propagation

high-frequency precursors

What about causality?

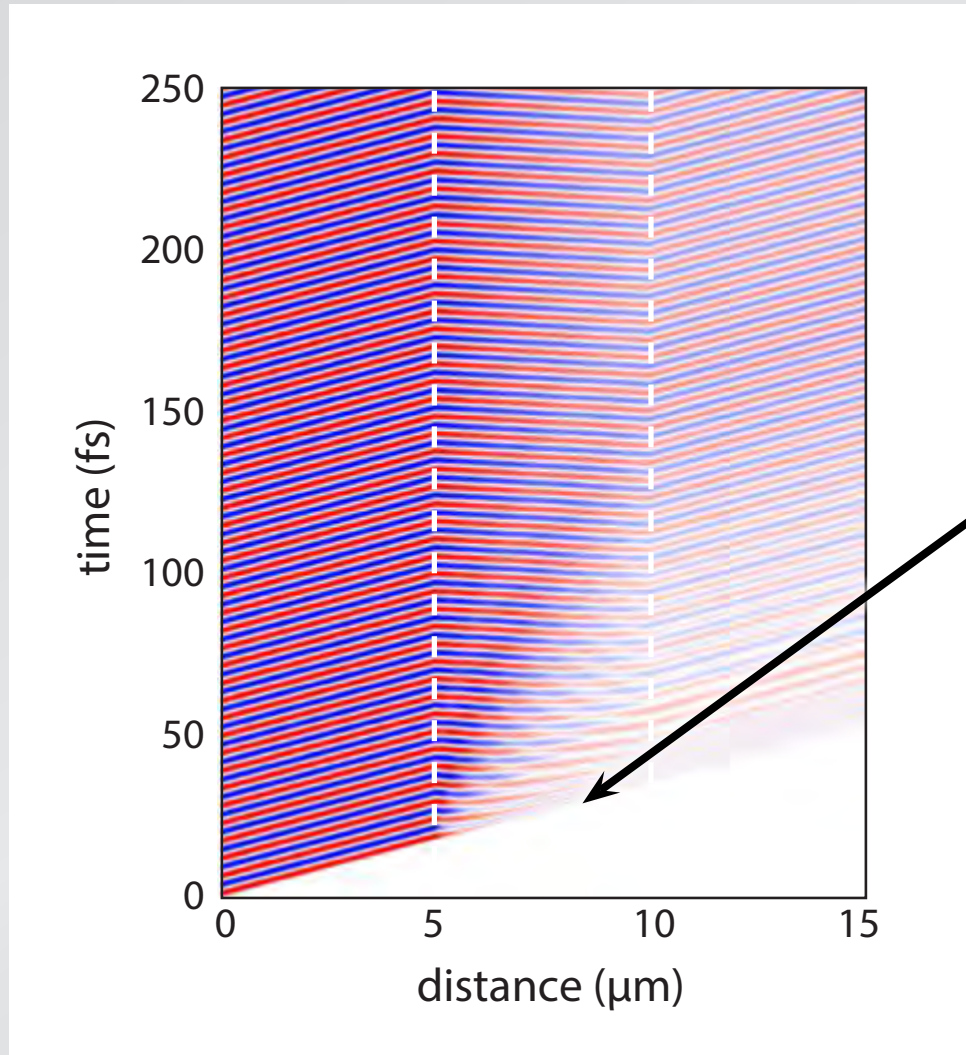

signal *always*
travels at speed c !

What about causality?

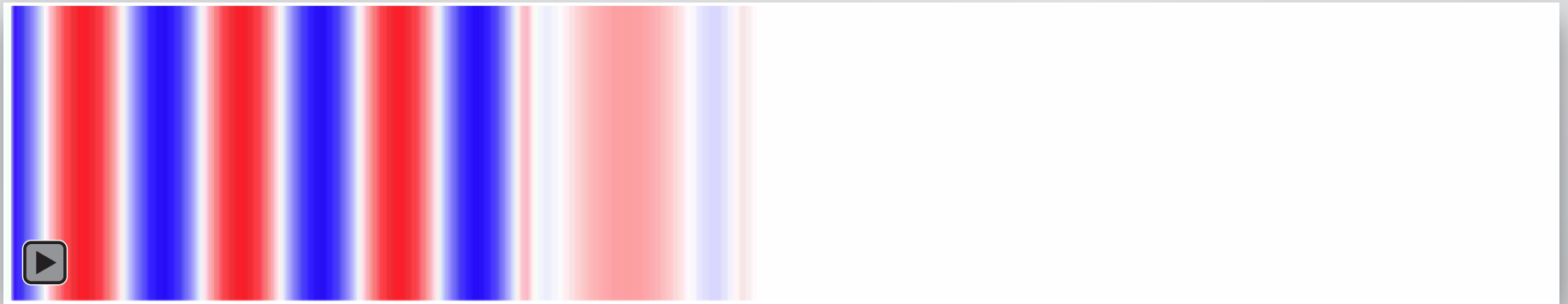

classification of (non-lossy) materials

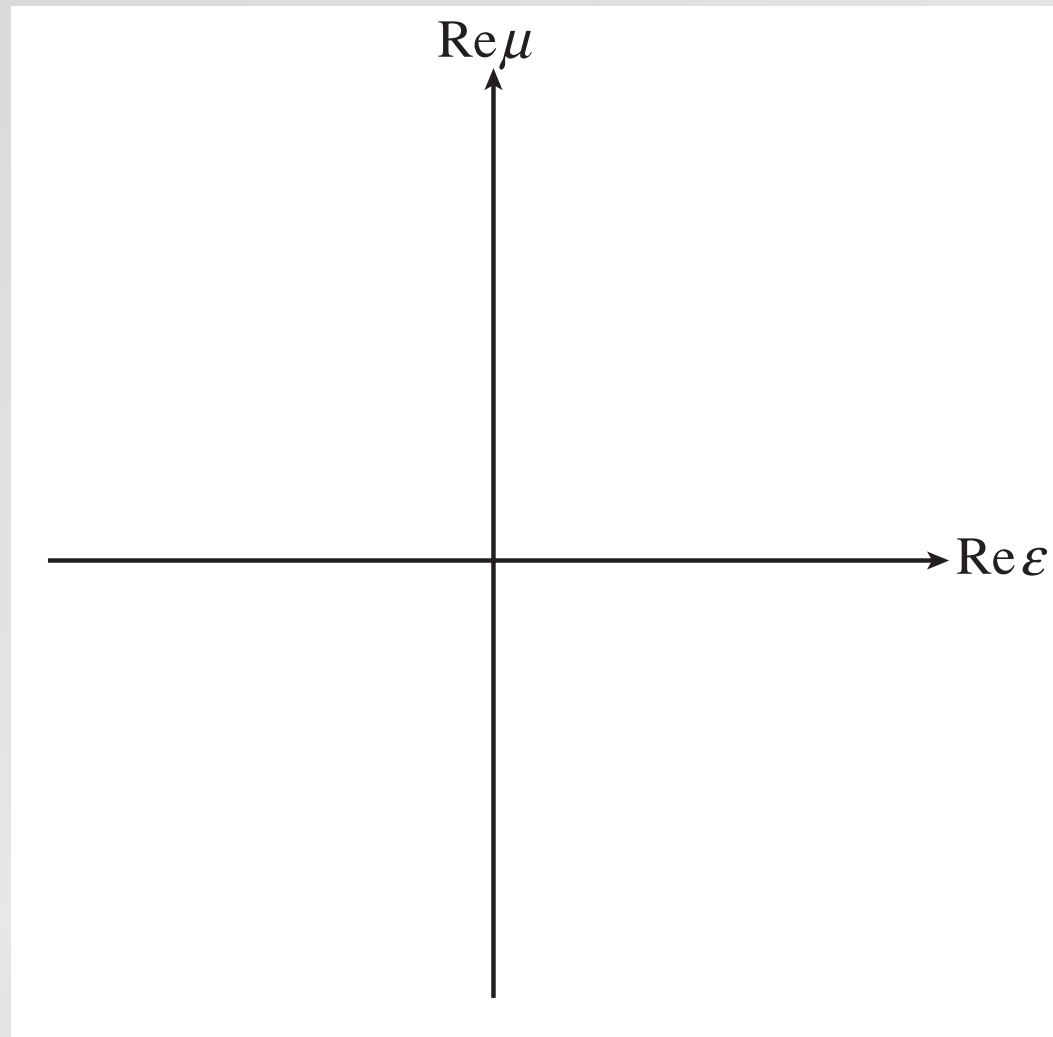

classification of (non-lossy) materials

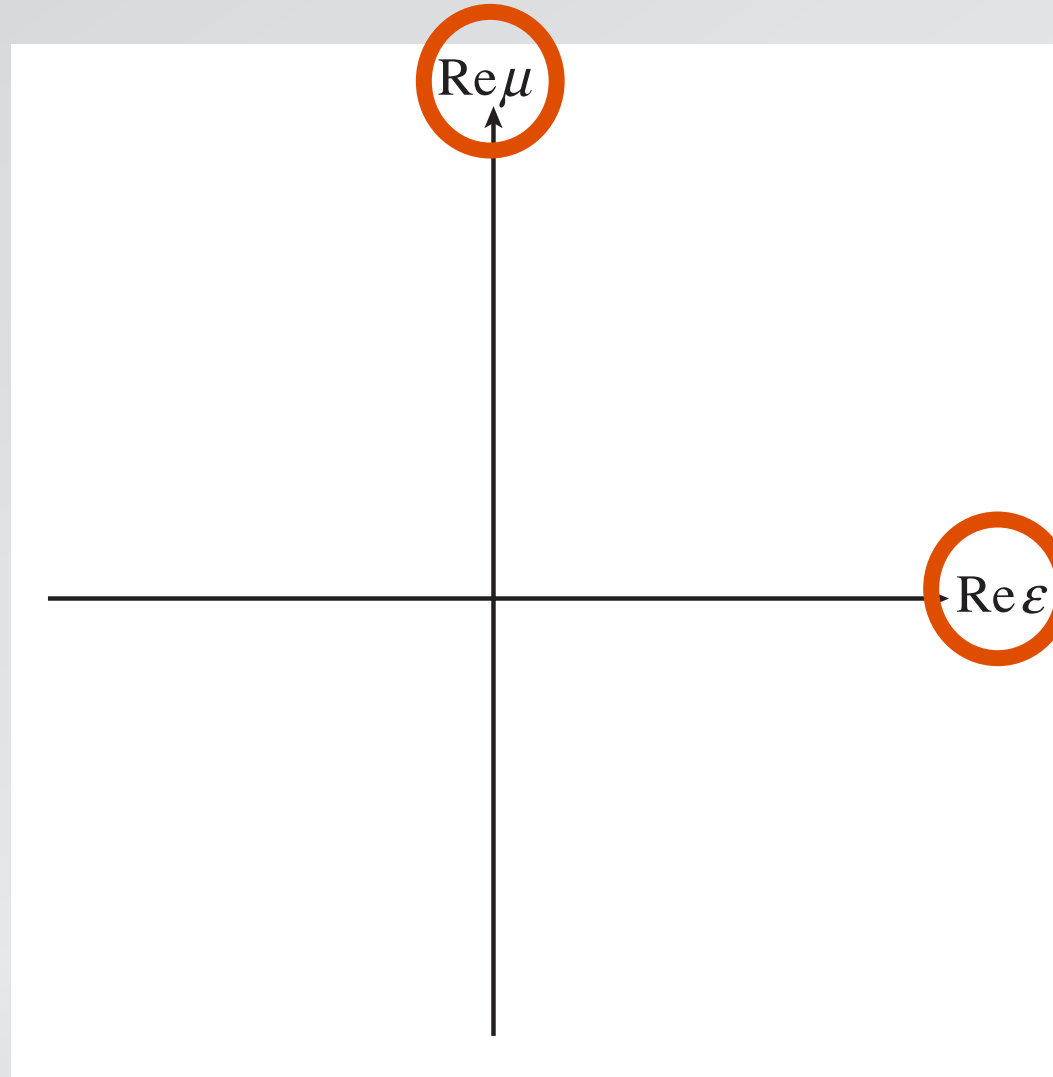

classification of (non-lossy) materials

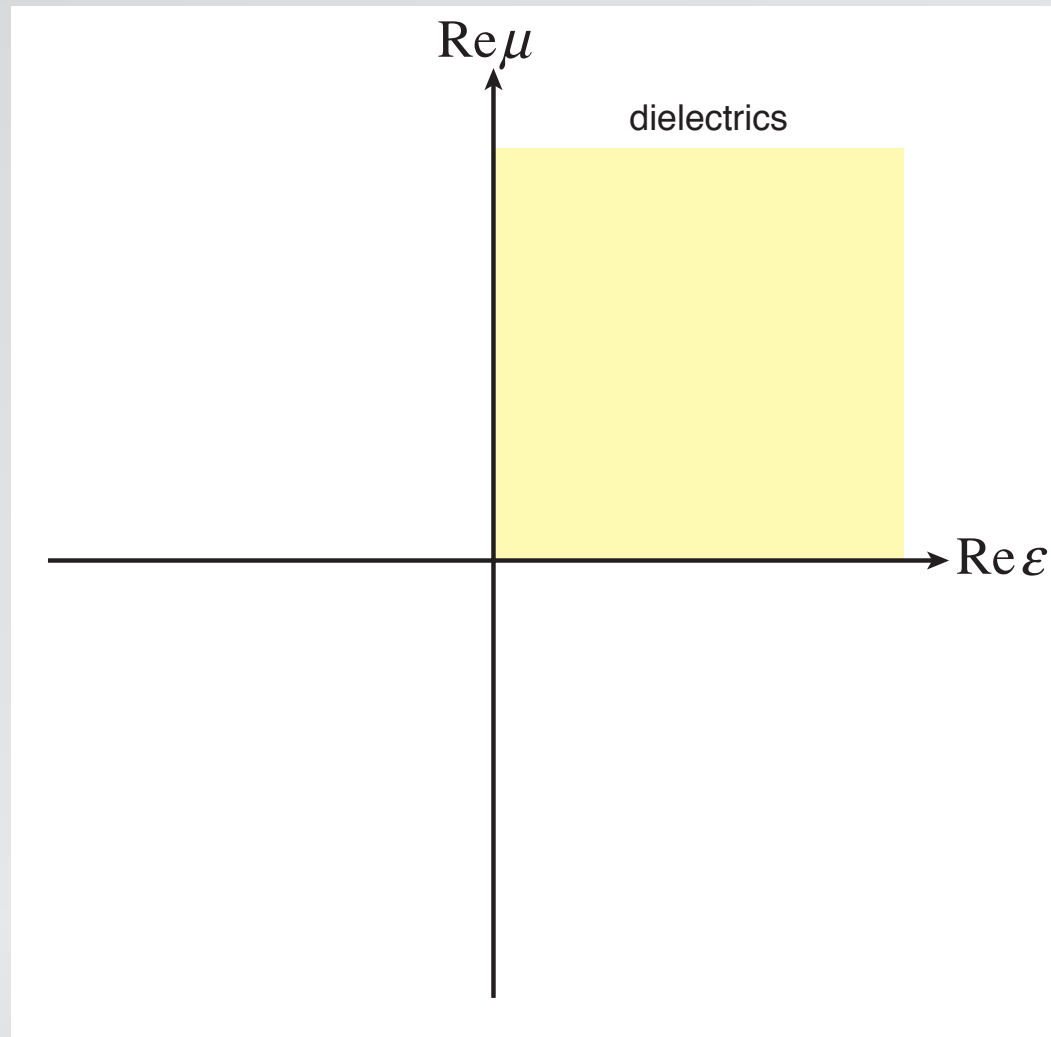

classification of (non-lossy) materials

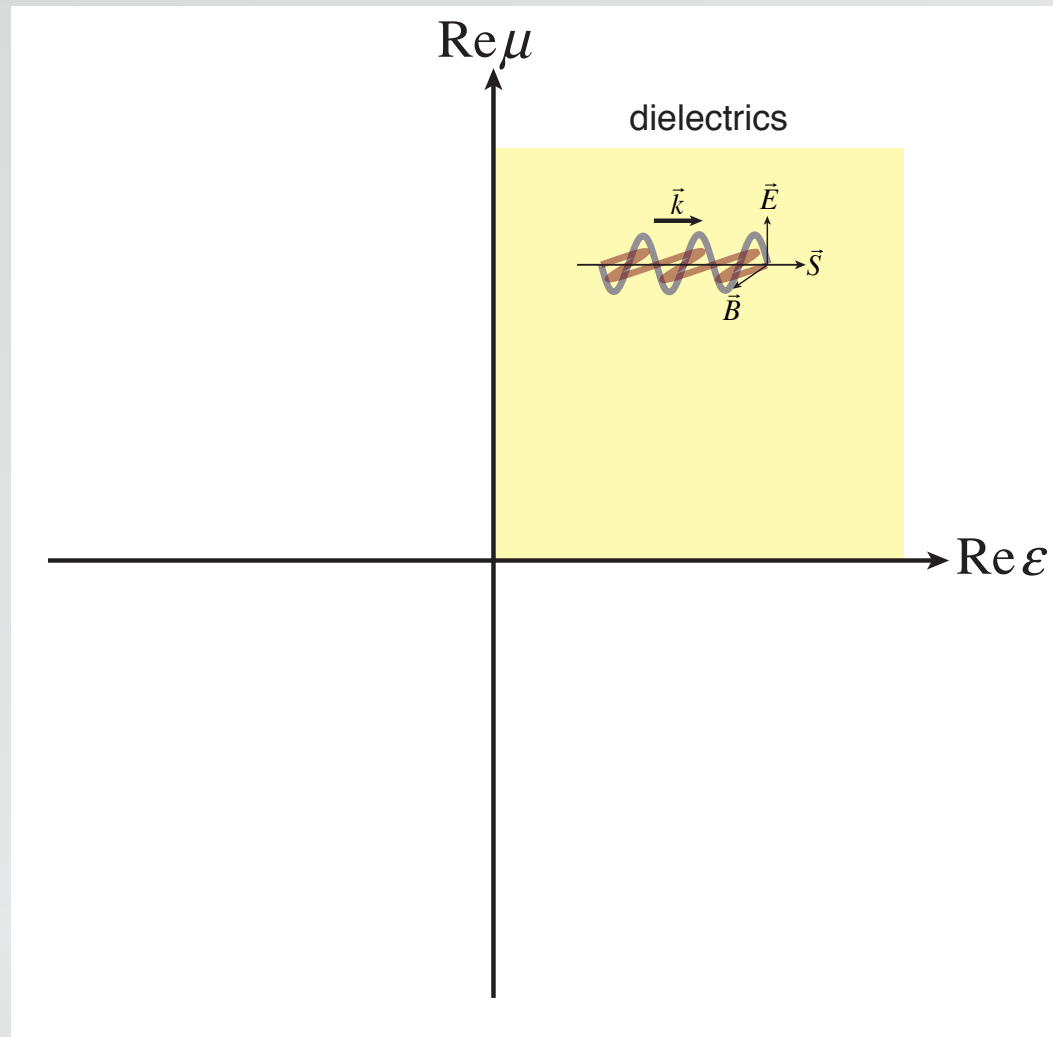

classification of (non-lossy) materials

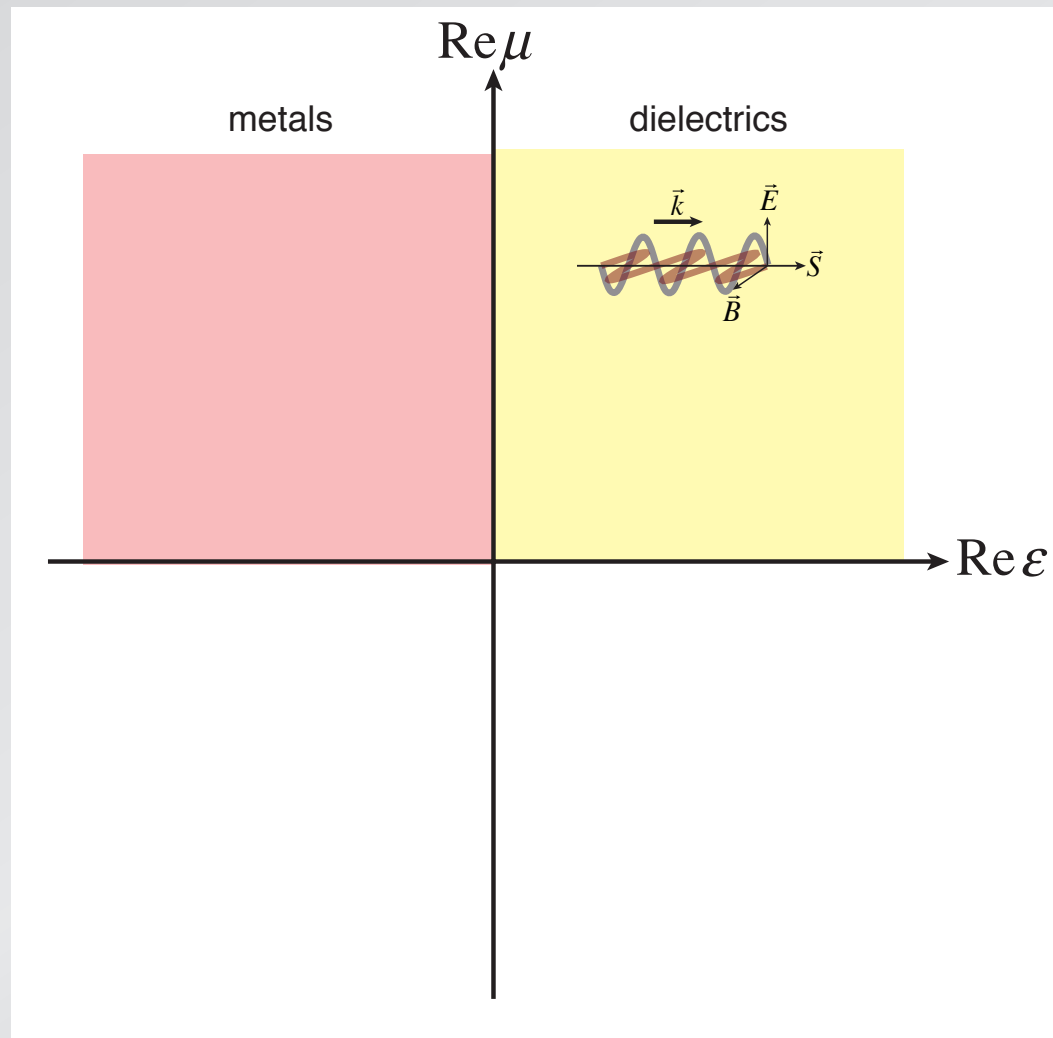

classification of (non-lossy) materials

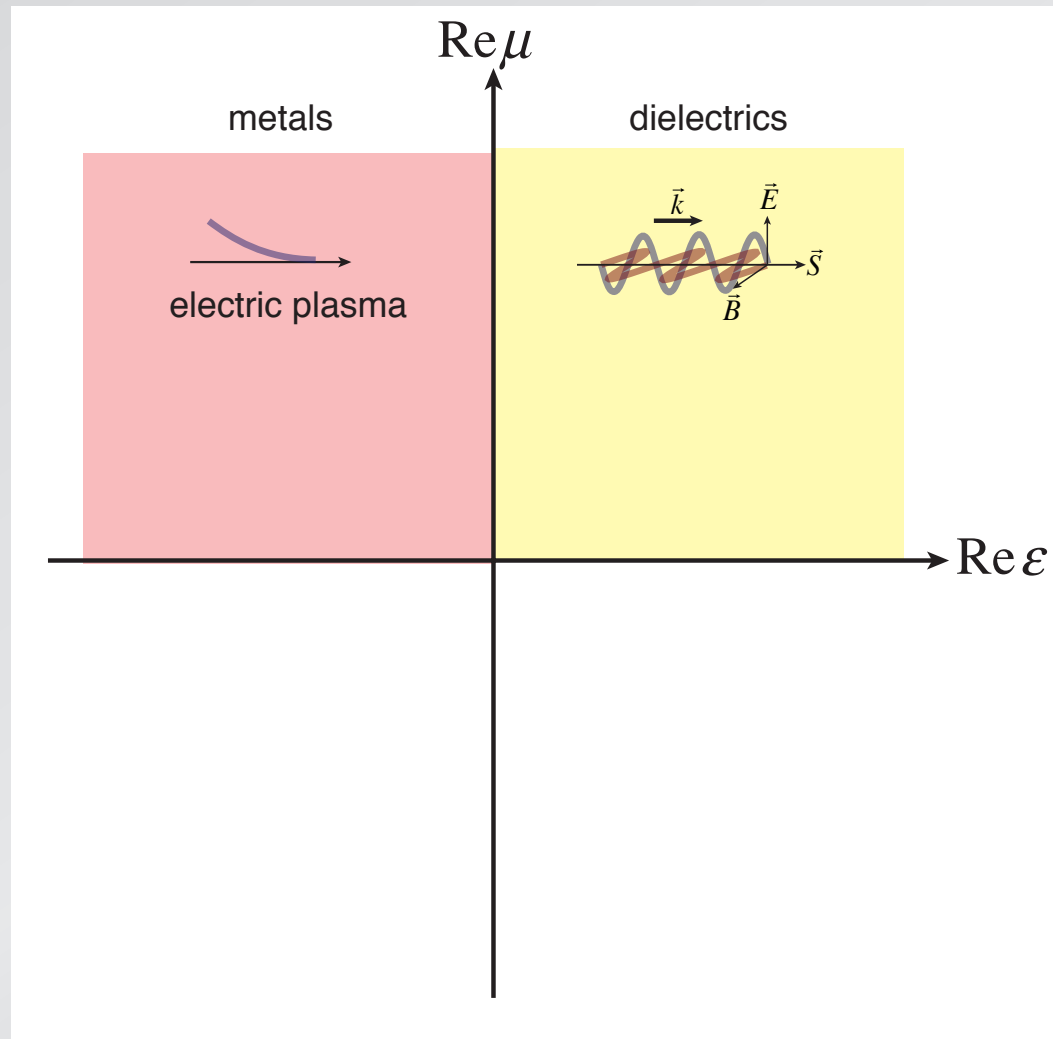

classification of (non-lossy) materials

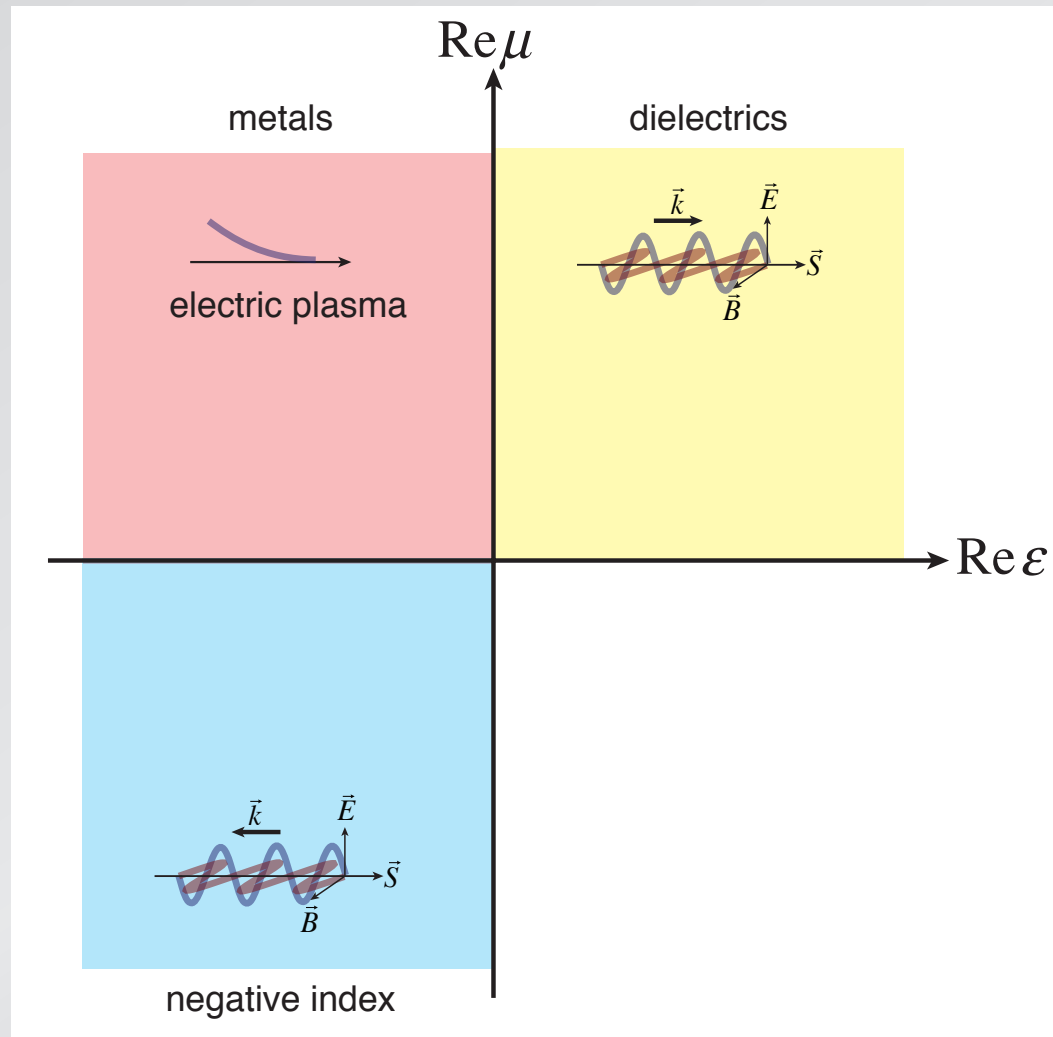

classification of (non-lossy) materials

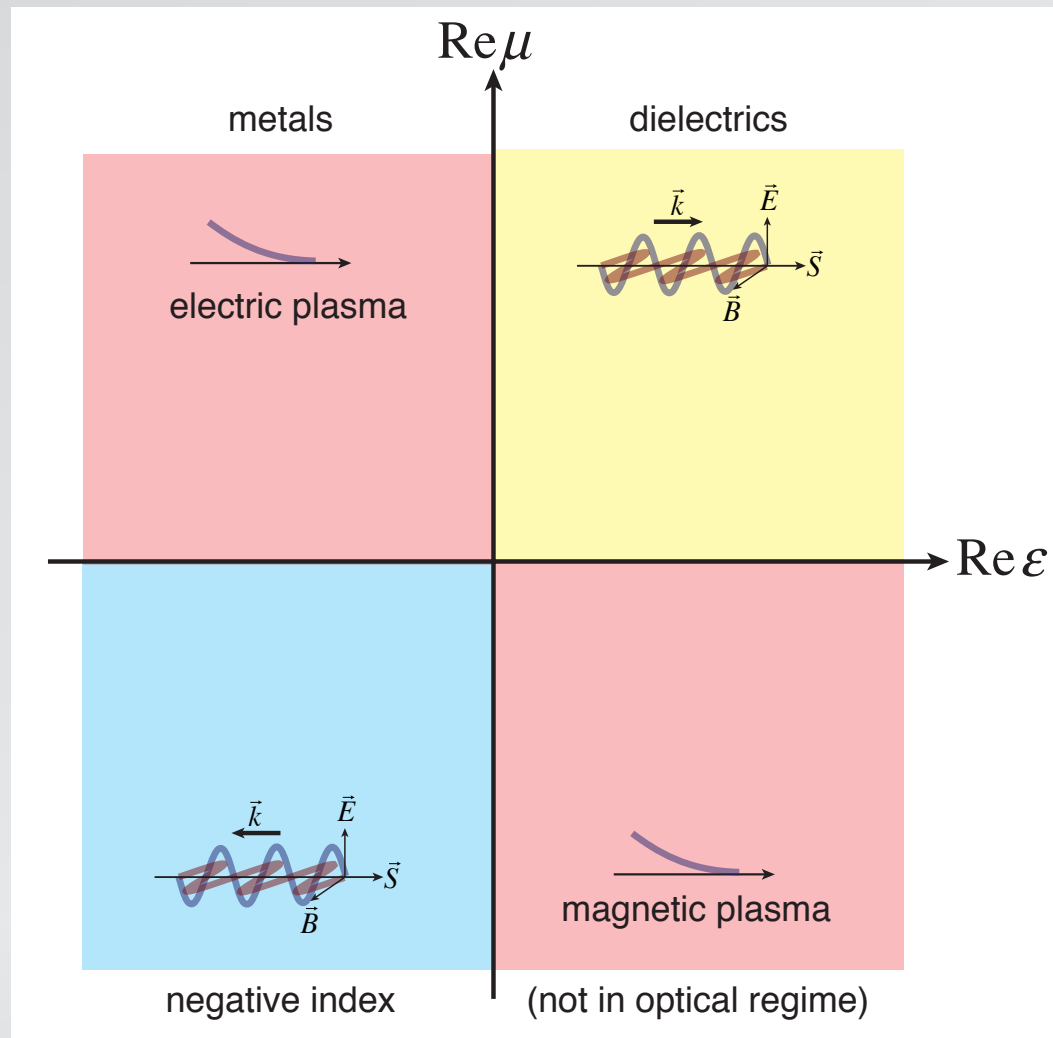

classification of (non-lossy) materials

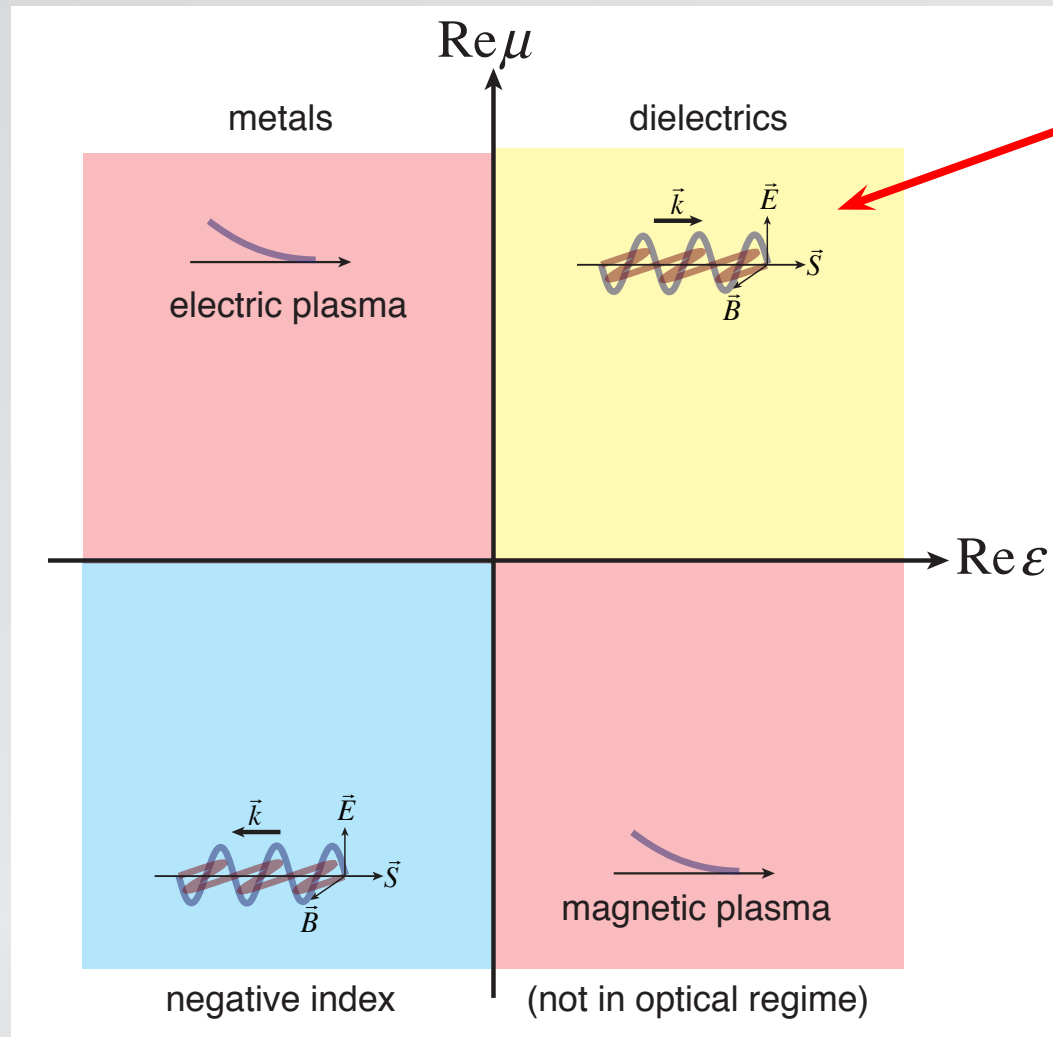

limited by diffraction

classification of (non-lossy) materials

no propagation

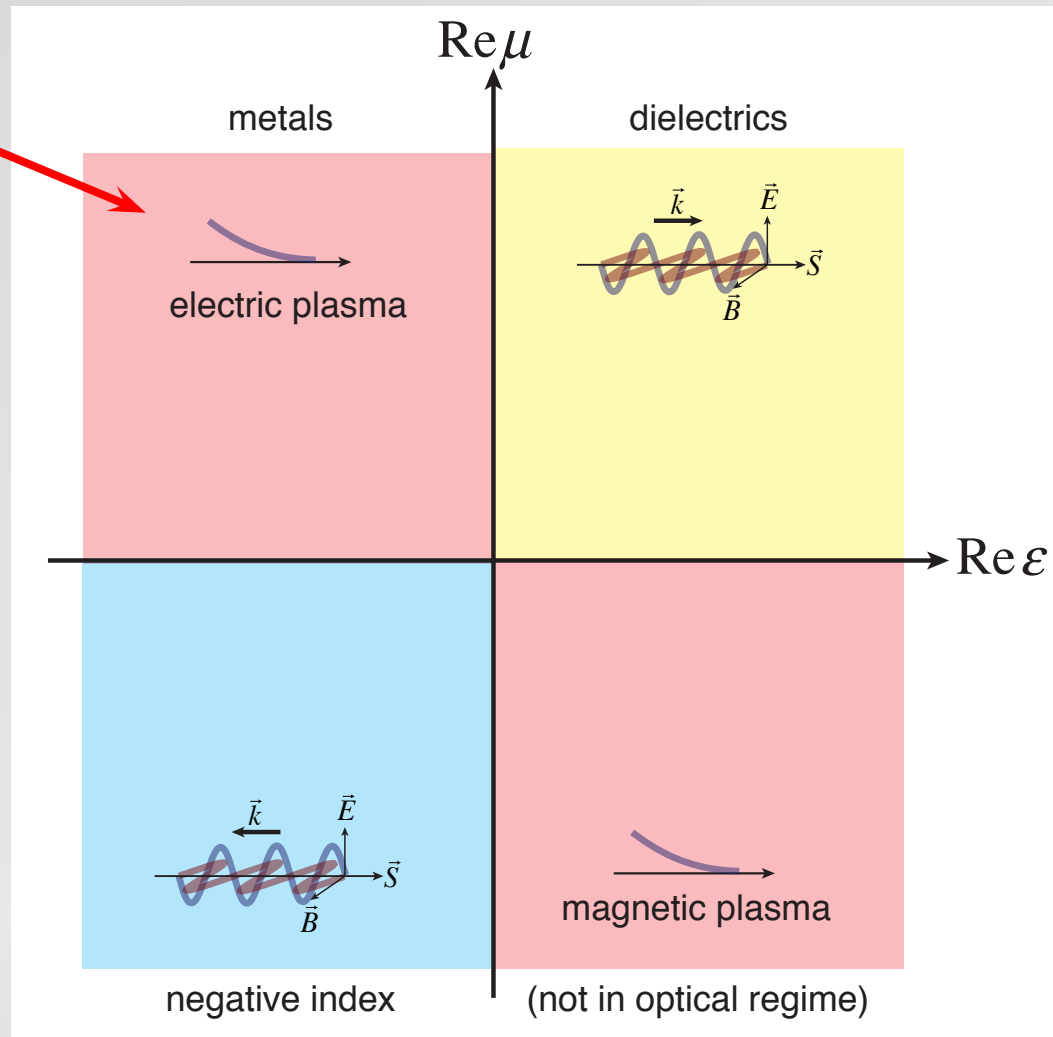

classification of (non-lossy) materials

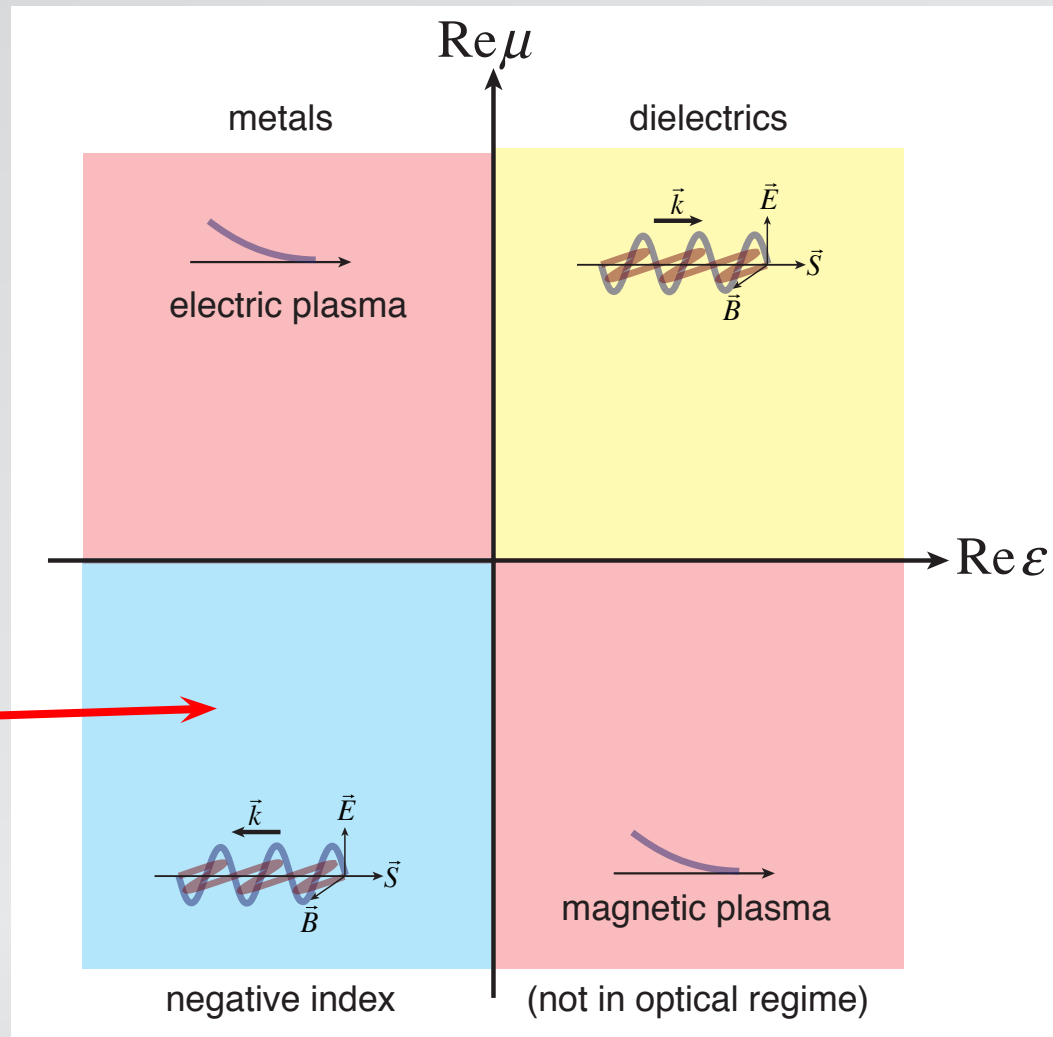

superlensing
but...



common materials very limited

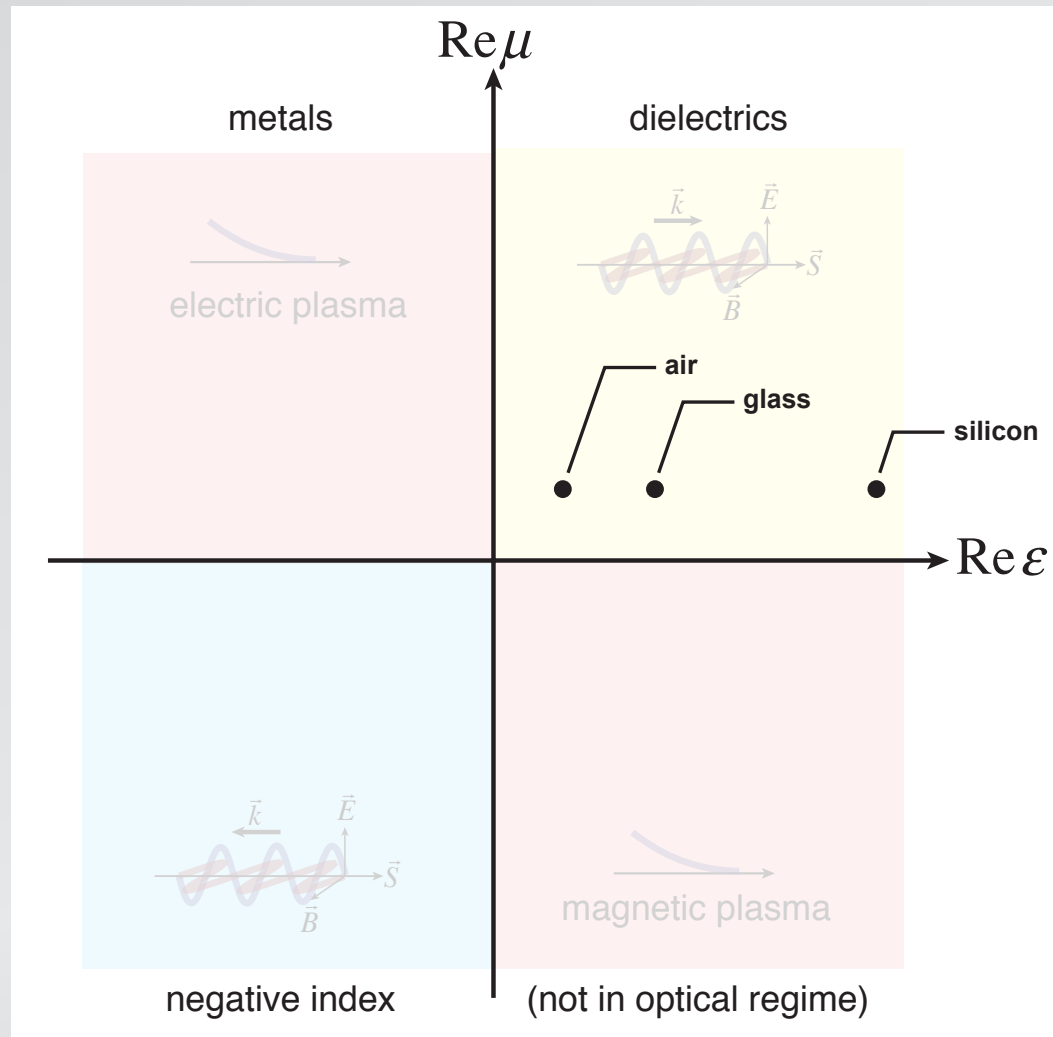

common materials very limited

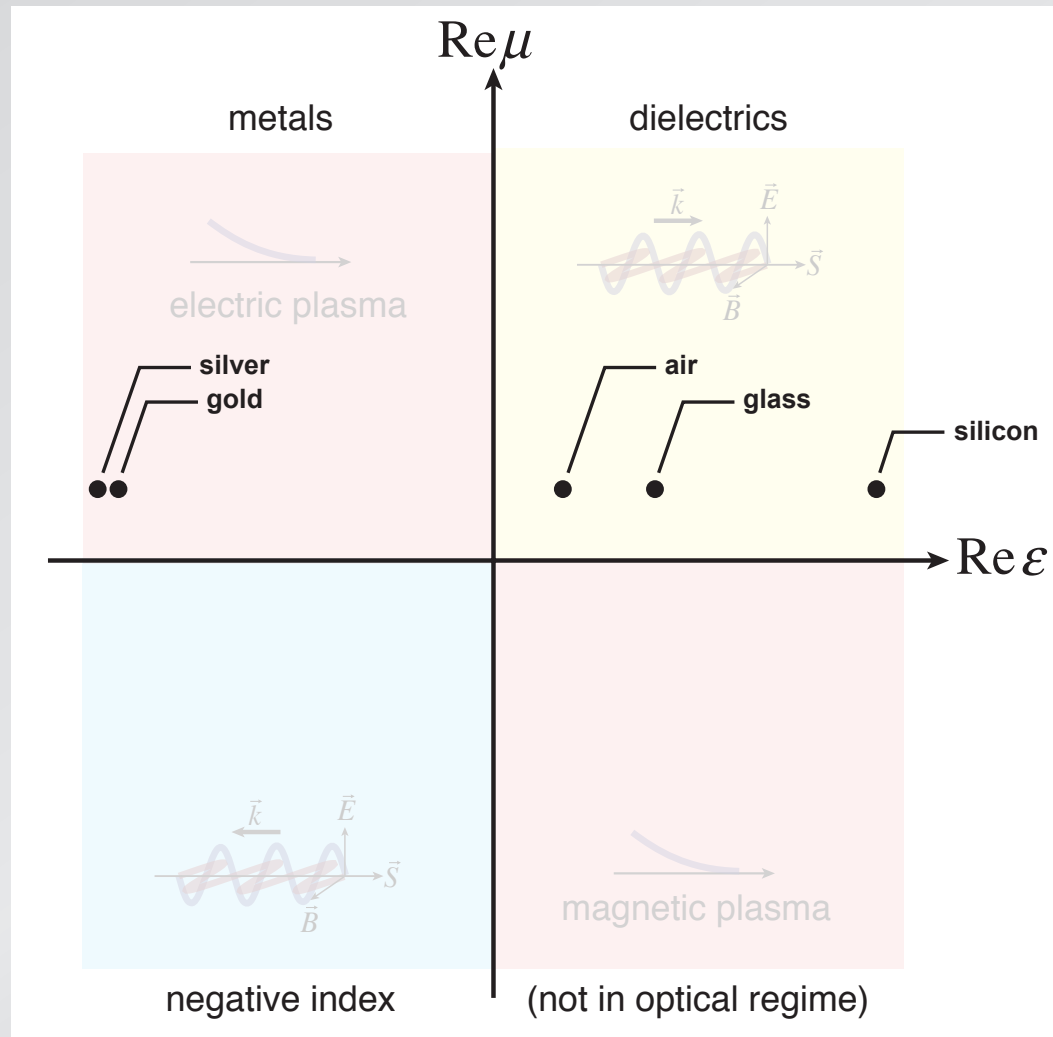

common materials very limited

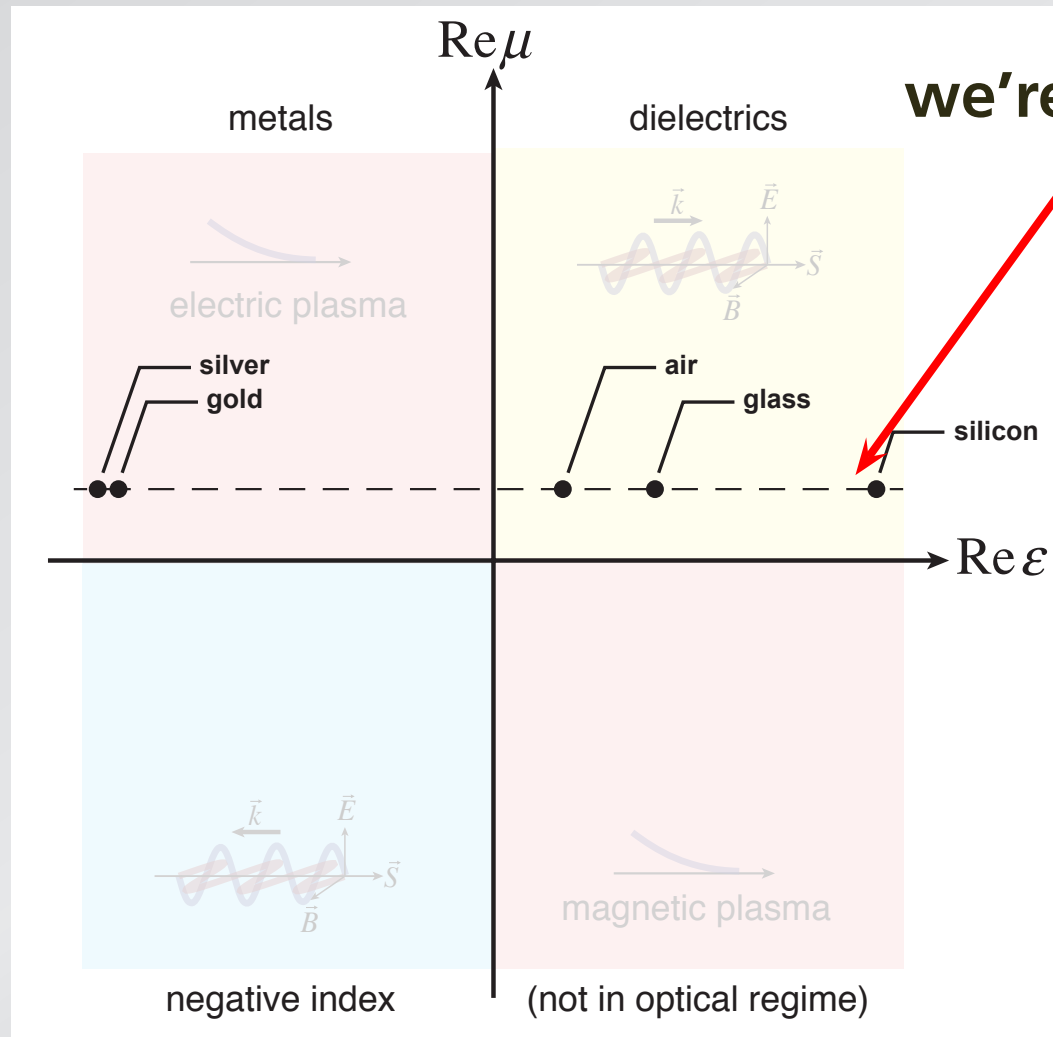

What happens on the axes?

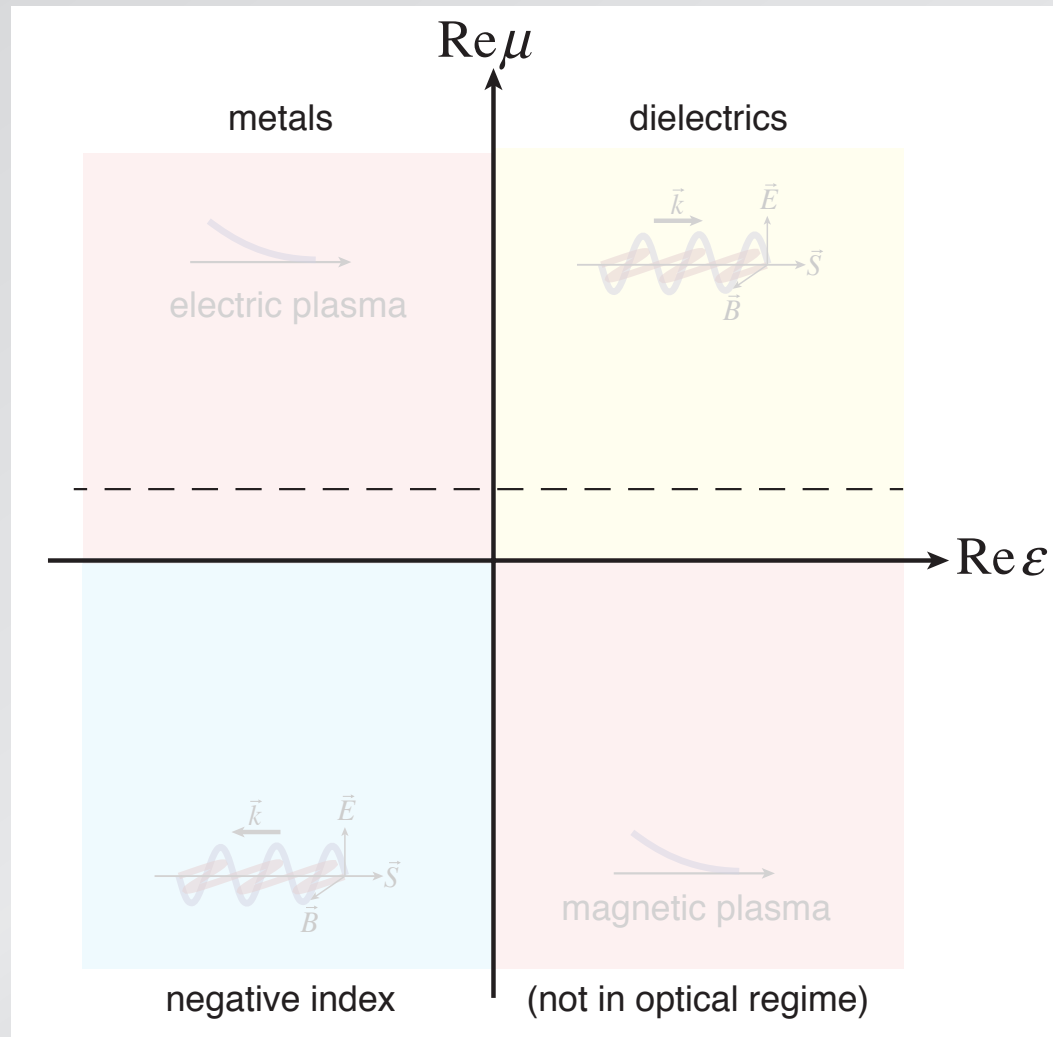

what if we let $\varepsilon = 0$?

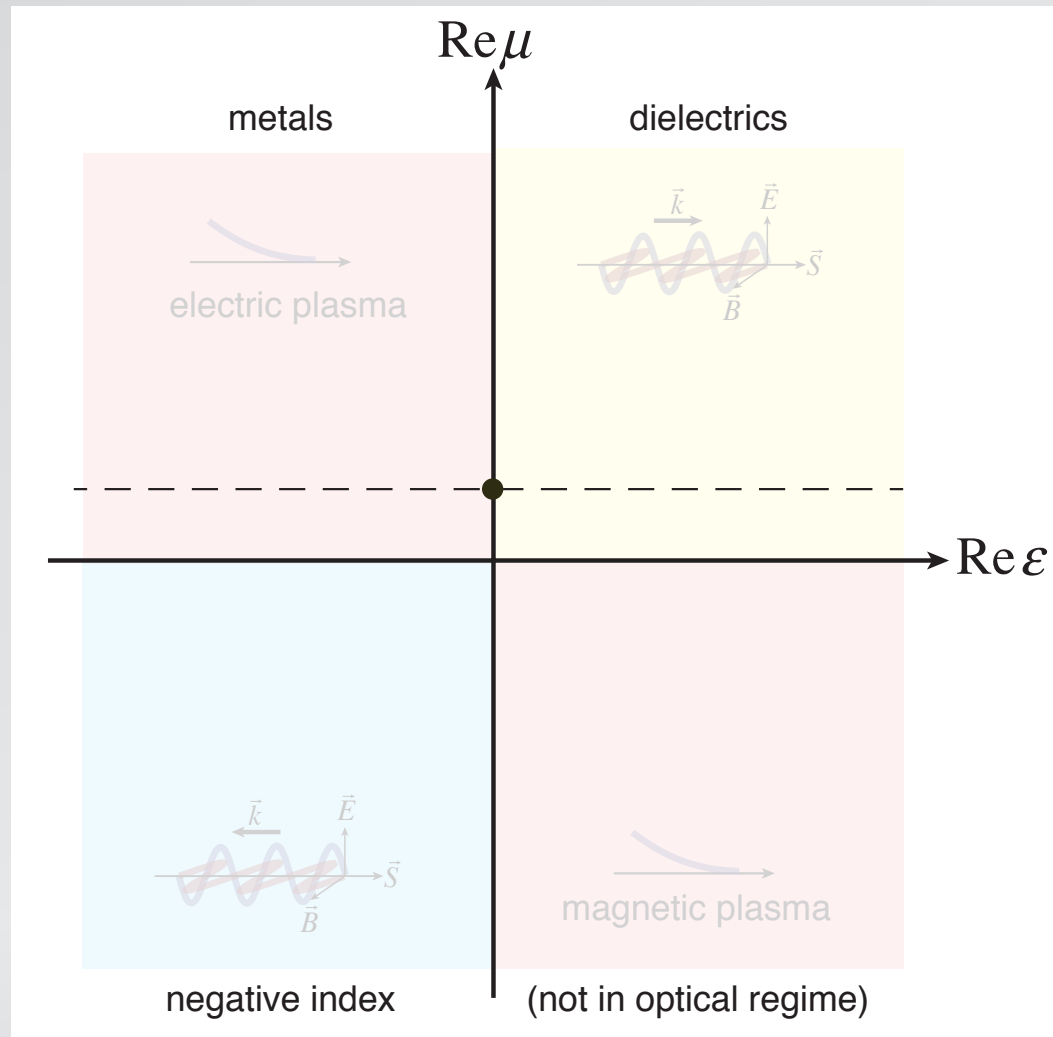

what if we let $\varepsilon = 0$?

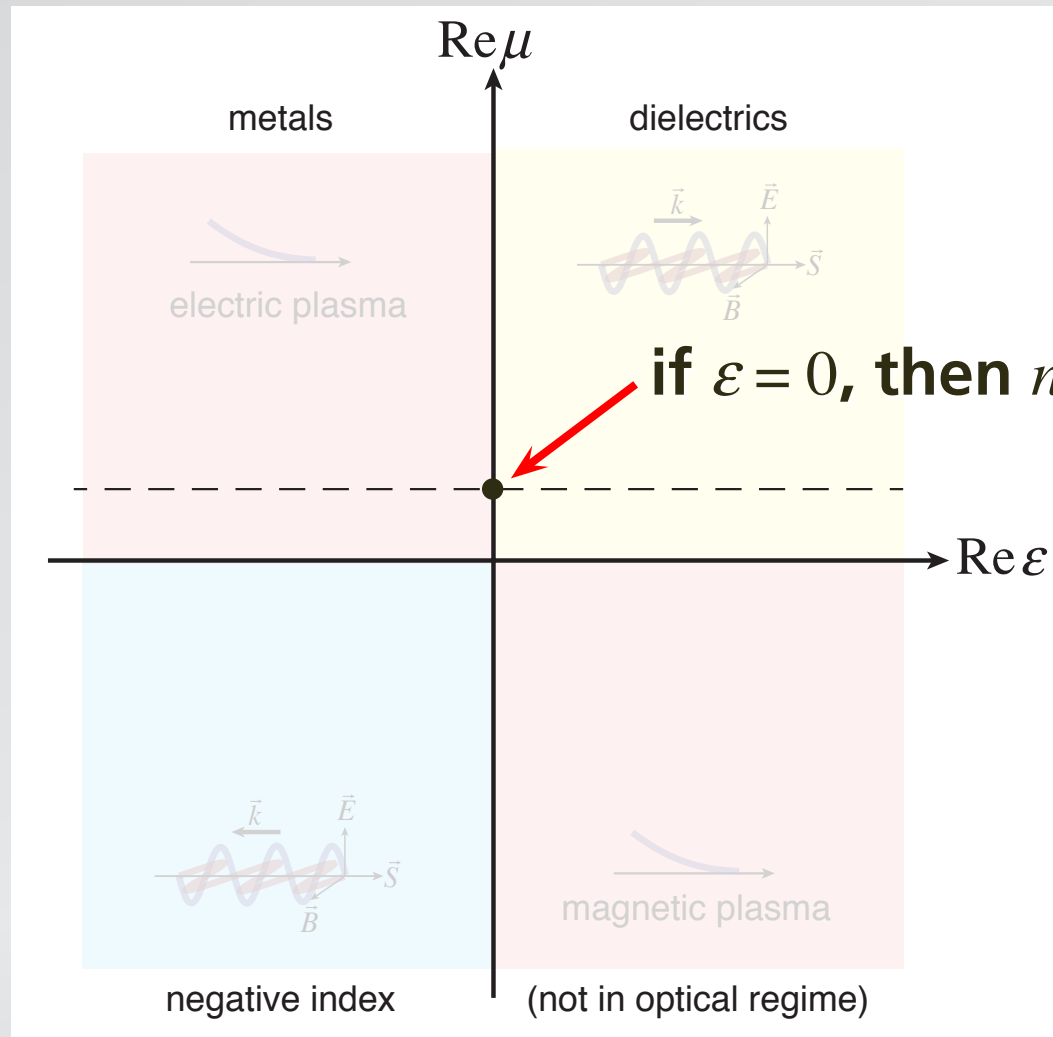

Q: If $n = 0$, which of the following is true?

- 1. the frequency goes to zero.**
- 2. the phase velocity becomes infinite.**
- 3. both of the above.**
- 4. neither of the above.**

wave equation

$$\nabla^2 \vec{E} - \frac{\mu\epsilon}{c^2} \frac{\partial^2 \vec{E}}{\partial t^2} = 0$$

solution

$$\vec{E} = \vec{E}_0 e^{i(kx - \omega t)}$$

where

$$\frac{\omega}{k} = \frac{1}{\sqrt{\epsilon\mu}} c = \frac{1}{n} c$$

wave equation

$$\nabla^2 \vec{E} - \frac{\mu \epsilon}{c^2} \frac{\partial^2 \vec{E}}{\partial t^2} = 0$$

solution

$$\vec{E} = \vec{E}_0 e^{i(kx - \omega t)}$$

where

$$\frac{\omega}{k} = \frac{1}{\sqrt{\epsilon \mu}} c = \frac{1}{n} c$$

wave equation

$$\nabla^2 \vec{E} - \frac{\mu \epsilon}{c^2} \frac{\partial^2 \vec{E}}{\partial t^2} = 0$$

solution

$$\vec{E} = \vec{E}_0 e^{i(kx - \omega t)} \longrightarrow \vec{E} = \vec{E}_0 e^{-i\omega t}$$

where

$$\frac{\omega}{k} = \frac{1}{\sqrt{\epsilon\mu}} c = \frac{1}{n} c$$

wave equation

$$\nabla^2 \vec{E} - \frac{\mu \epsilon}{c^2} \frac{\partial^2 \vec{E}}{\partial t^2} = 0$$

solution

$$\vec{E} = \vec{E}_0 e^{i(kx - \omega t)} \longrightarrow \vec{E} = \vec{E}_0 e^{-i\omega t}$$

where

$$\frac{\omega}{k} = \frac{1}{\sqrt{\epsilon\mu}} c = \frac{1}{n} c \longrightarrow \infty$$

1 index

2 zero index

Q: If $n = 0$, which of the following is true?

1. the frequency goes to zero.
- 2. the phase velocity becomes infinite. ✓**
3. both of the above.
4. neither of the above.

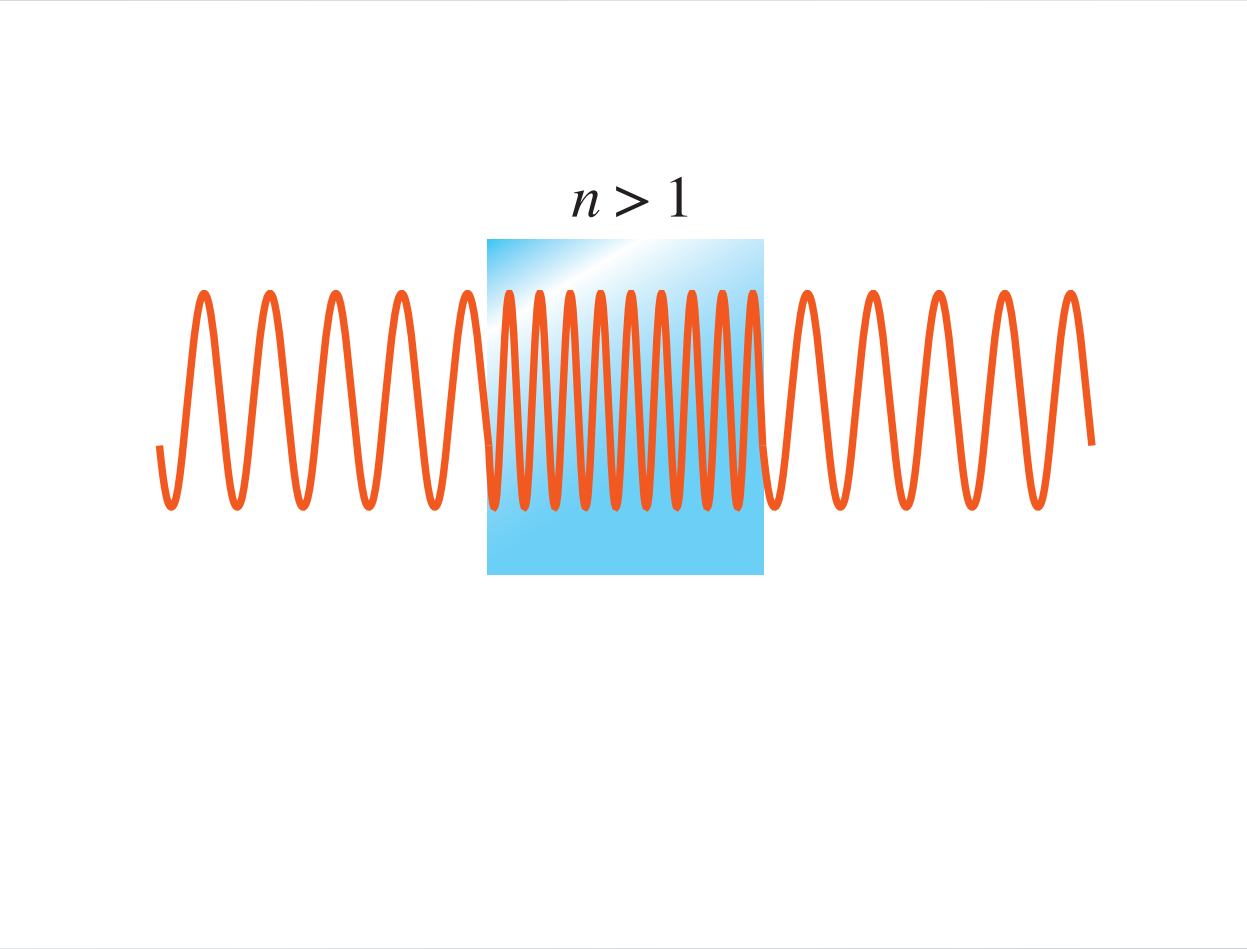

1 index

2 zero index

$$0 < n < 1$$

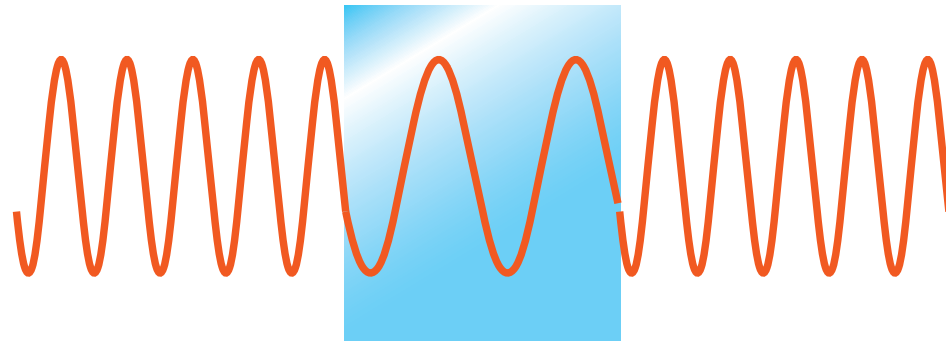

1 index

2 zero index

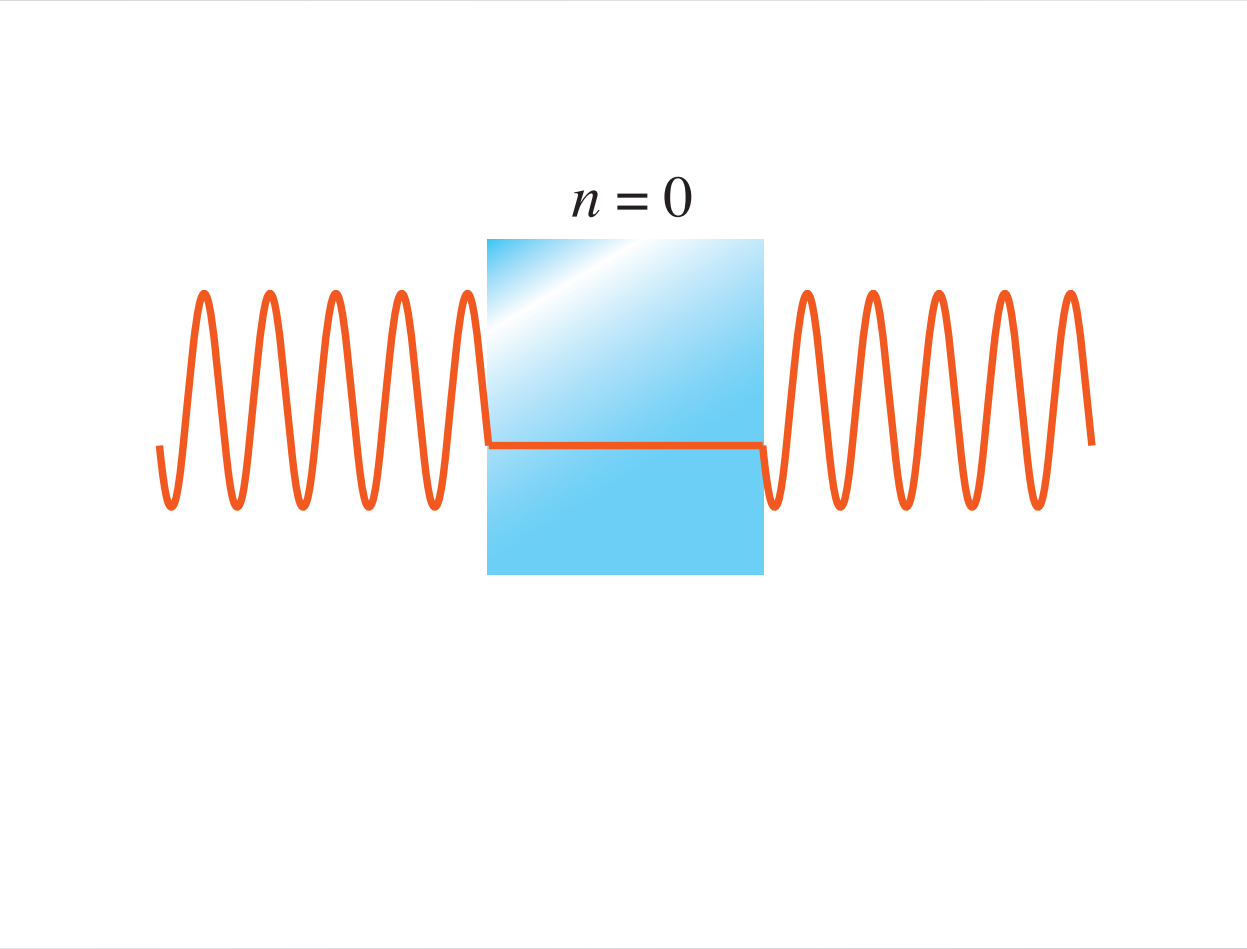

1 index

2 zero index

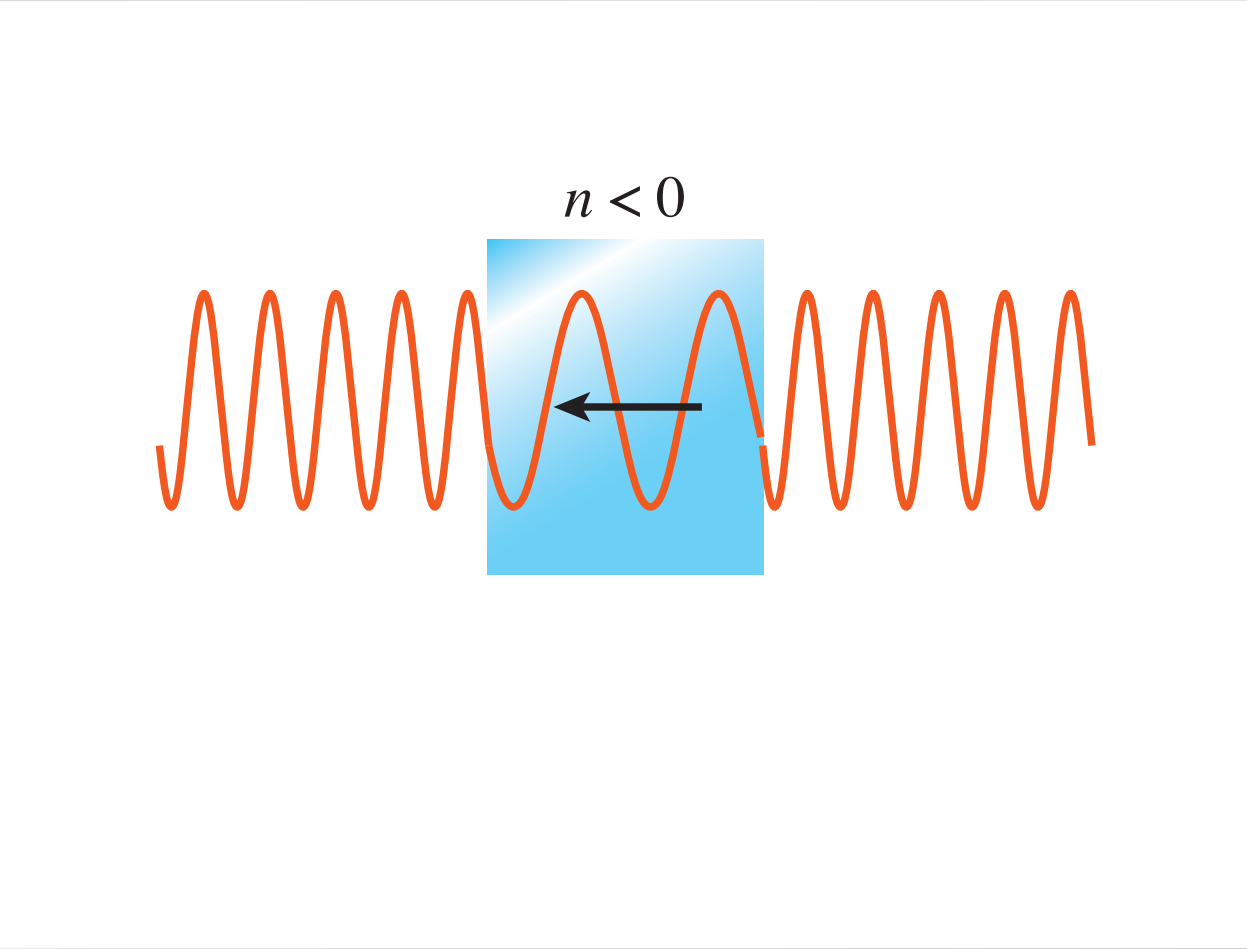

1 index

2 zero index



1 index

2 zero index

What can we do with uniform phase?

1 index

2 zero index

$$n = 0$$

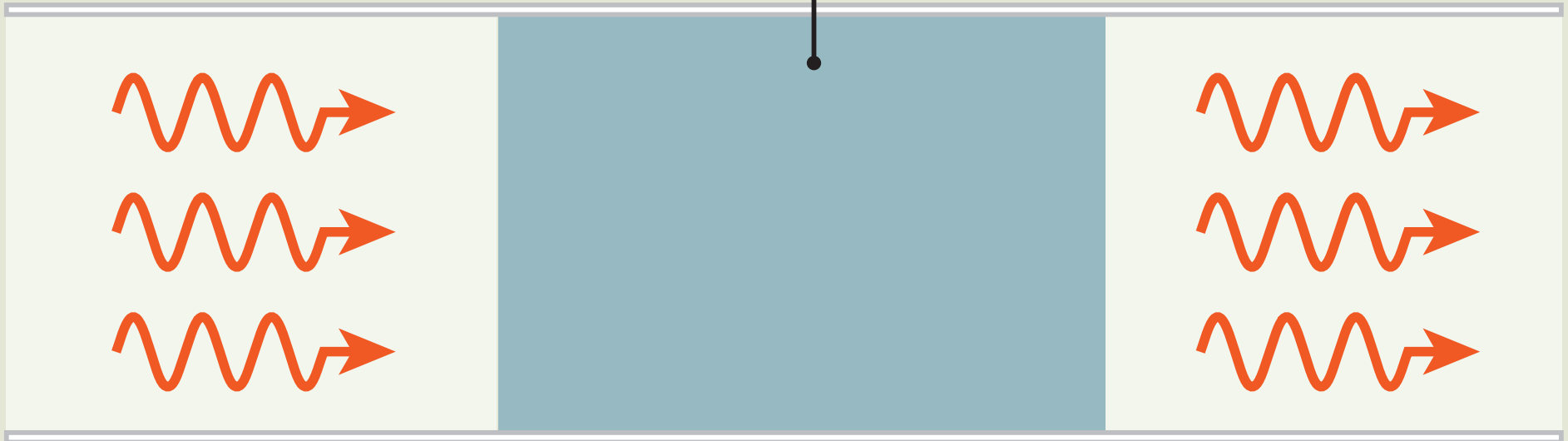

1 index

2 zero index

$$n = 0$$

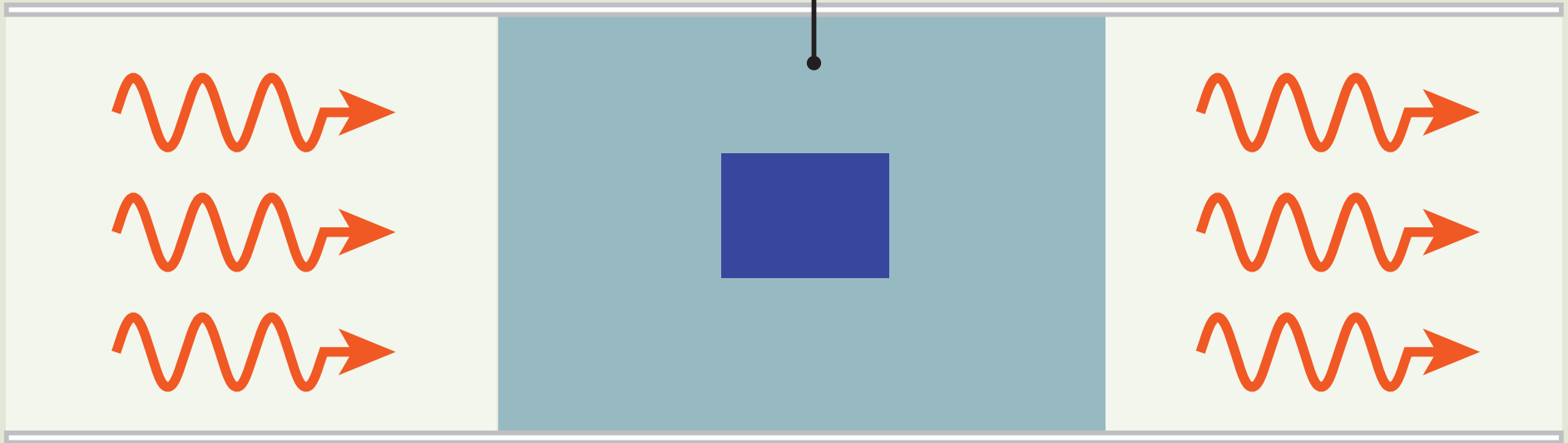

1 index

2 zero index

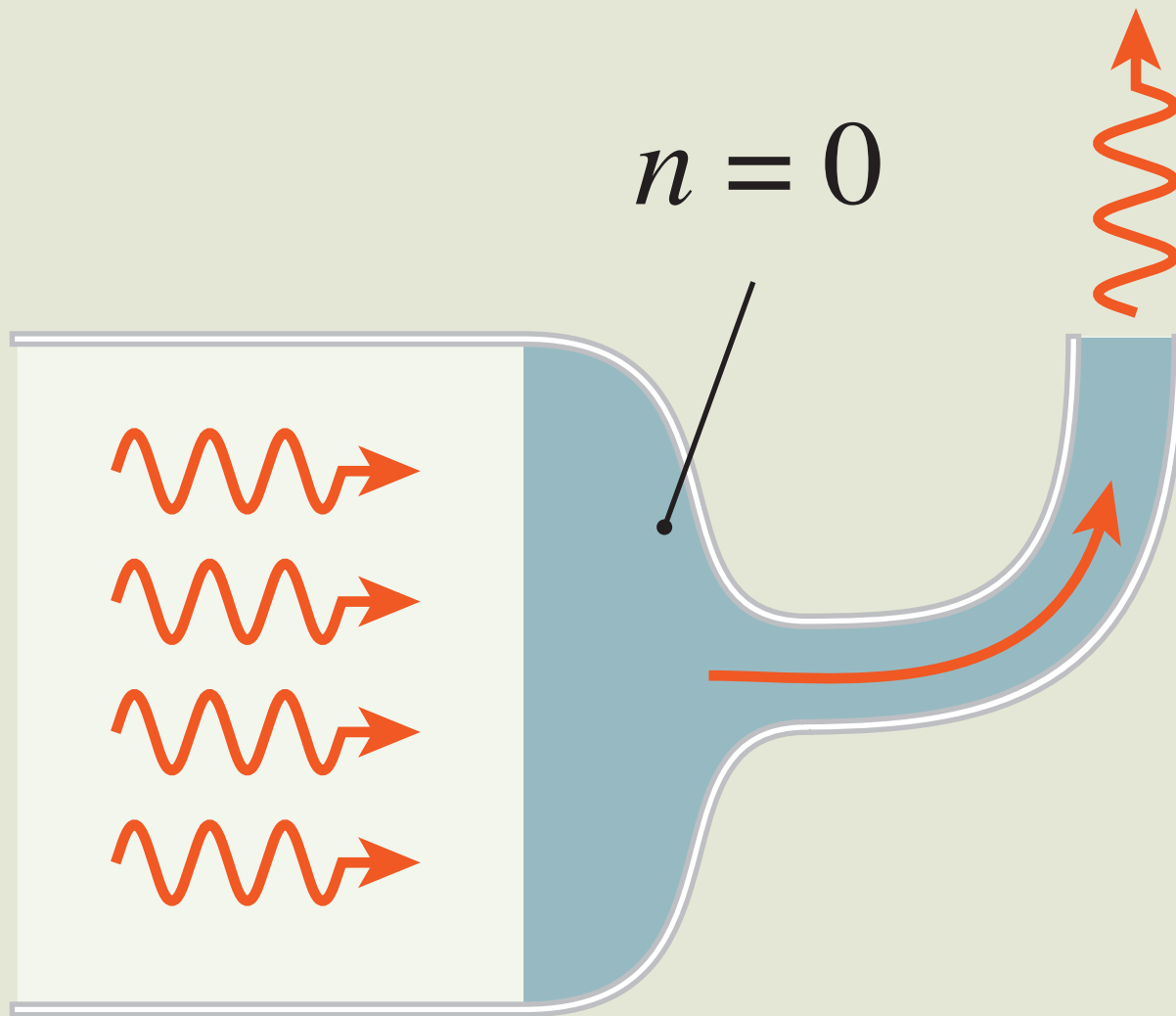

1 index

2 zero index

“tunneling with infinite decay length”

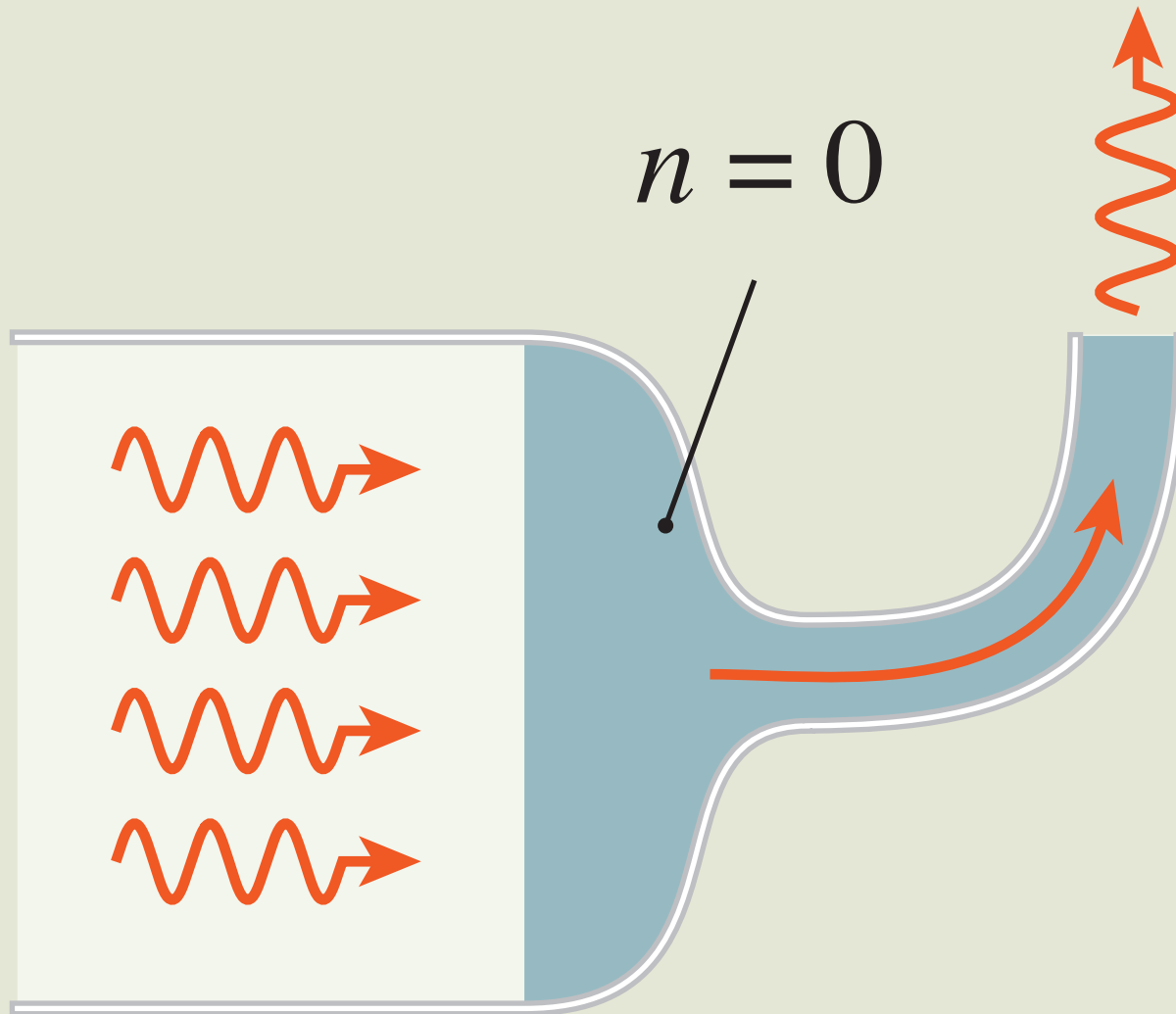

1 index

2 zero index

how?

$$n = \sqrt{\varepsilon\mu}$$

how?

$$n = \sqrt{\epsilon\mu}$$

but ϵ and μ also determine reflectivity

$$R = \frac{Z - 1}{Z + 1}$$

how?

$$n = \sqrt{\epsilon\mu}$$

but ϵ and μ also determine reflectivity

$$R = \frac{Z - 1}{Z + 1}$$

where

$$Z = \sqrt{\frac{\mu}{\epsilon}}$$

how?

$$\varepsilon \rightarrow 0$$

$$n = \sqrt{\varepsilon\mu} \rightarrow 0$$

but ε and μ also determine reflectivity

$$R = \frac{Z - 1}{Z + 1}$$

where

$$Z = \sqrt{\frac{\mu}{\varepsilon}}$$

how?

$$\varepsilon \rightarrow 0$$

$$n = \sqrt{\varepsilon\mu} \rightarrow 0$$

but ε and μ also determine reflectivity

$$R = \frac{Z - 1}{Z + 1}$$

where

$$Z = \sqrt{\frac{\mu}{\varepsilon}} \rightarrow \infty$$

how?

$$\varepsilon \rightarrow 0$$

$$n = \sqrt{\varepsilon\mu} \rightarrow 0$$

but ε and μ also determine reflectivity

$$R = \frac{Z-1}{Z+1} \rightarrow 1$$

where

$$Z = \sqrt{\frac{\mu}{\varepsilon}} \rightarrow \infty$$

how?

$$\mu \rightarrow 0$$

$$n = \sqrt{\epsilon\mu} \rightarrow 0$$

but ϵ and μ also determine reflectivity

$$R = \frac{Z - 1}{Z + 1}$$

where

$$Z = \sqrt{\frac{\mu}{\epsilon}}$$

how?

$$\mu \rightarrow 0$$

$$n = \sqrt{\epsilon\mu} \rightarrow 0$$

but ϵ and μ also determine reflectivity

$$R = \frac{Z - 1}{Z + 1}$$

where

$$Z = \sqrt{\frac{\mu}{\epsilon}} \rightarrow 0$$

how?

$$\mu \rightarrow 0$$

$$n = \sqrt{\epsilon\mu} \rightarrow 0$$

but ϵ and μ also determine reflectivity

$$R = \frac{Z-1}{Z+1} \rightarrow -1$$

where

$$Z = \sqrt{\frac{\mu}{\epsilon}} \rightarrow 0$$

how?

$$\epsilon, \mu \rightarrow 0$$

$$n = \sqrt{\epsilon\mu} \rightarrow 0$$

but ϵ and μ also determine reflectivity

$$R = \frac{Z - 1}{Z + 1}$$

where

$$Z = \sqrt{\frac{\mu}{\epsilon}} \quad \text{finite!}$$

but $\mu \neq 1$ requires a magnetic response!

1 index

2 zero index

3 experiments

Engineering a magnetic response

1 index

2 zero index

3 experiments

Engineering a magnetic response

bulk material

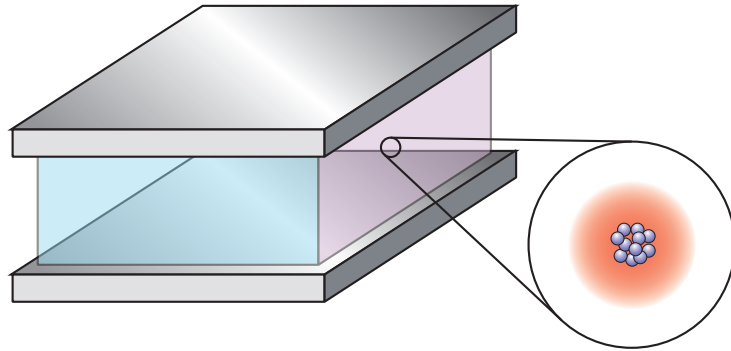

**properties derive from
constituent atoms**

1 index

2 zero index

3 experiments

Engineering a magnetic response

bulk material

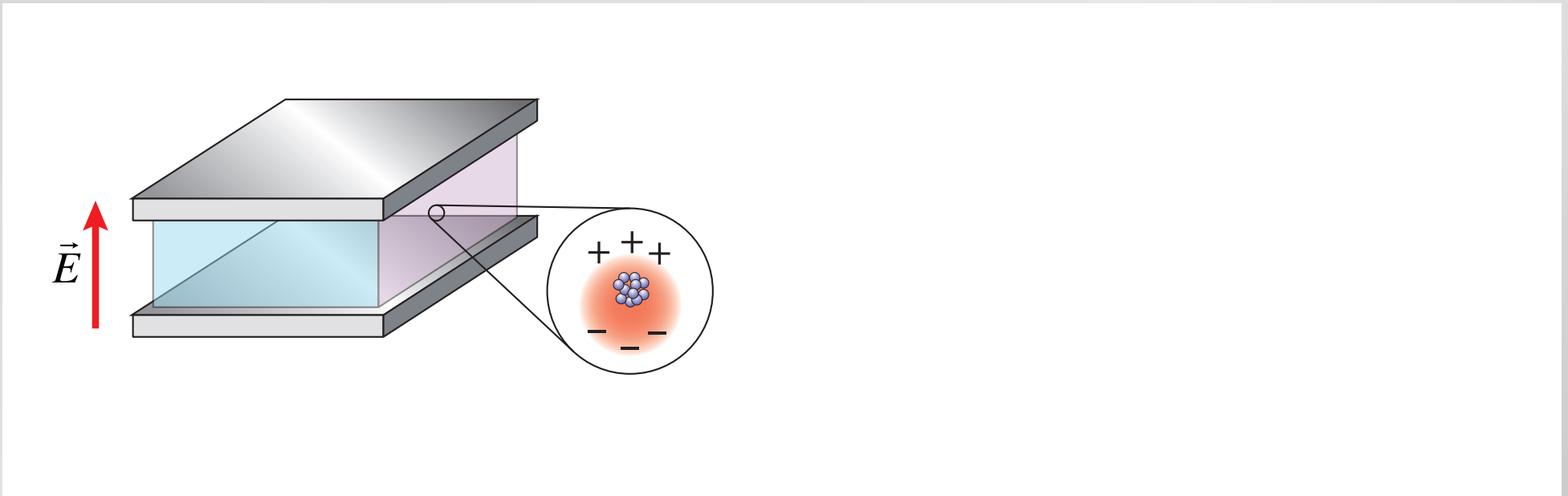

properties derive from
constituent atoms

1 index

2 zero index

3 experiments

Engineering a magnetic response

bulk material

composite material

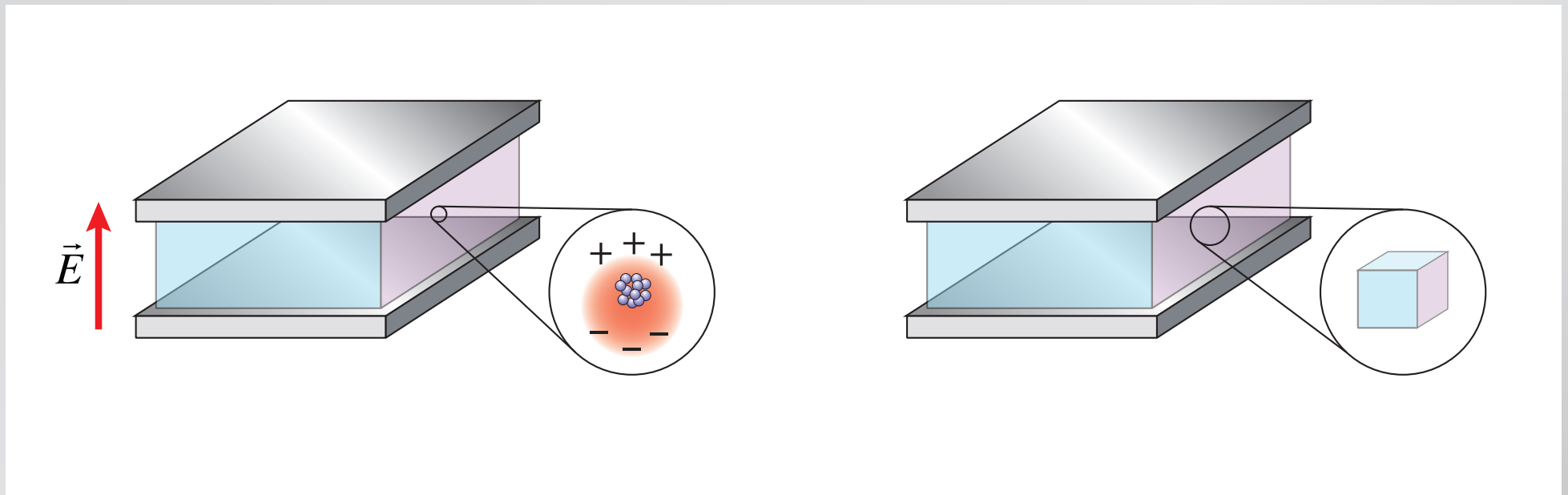

properties derive from
constituent atoms

properties derive from
constituent units

1 index

2 zero index

3 experiments

Engineering a magnetic response

bulk material

composite material

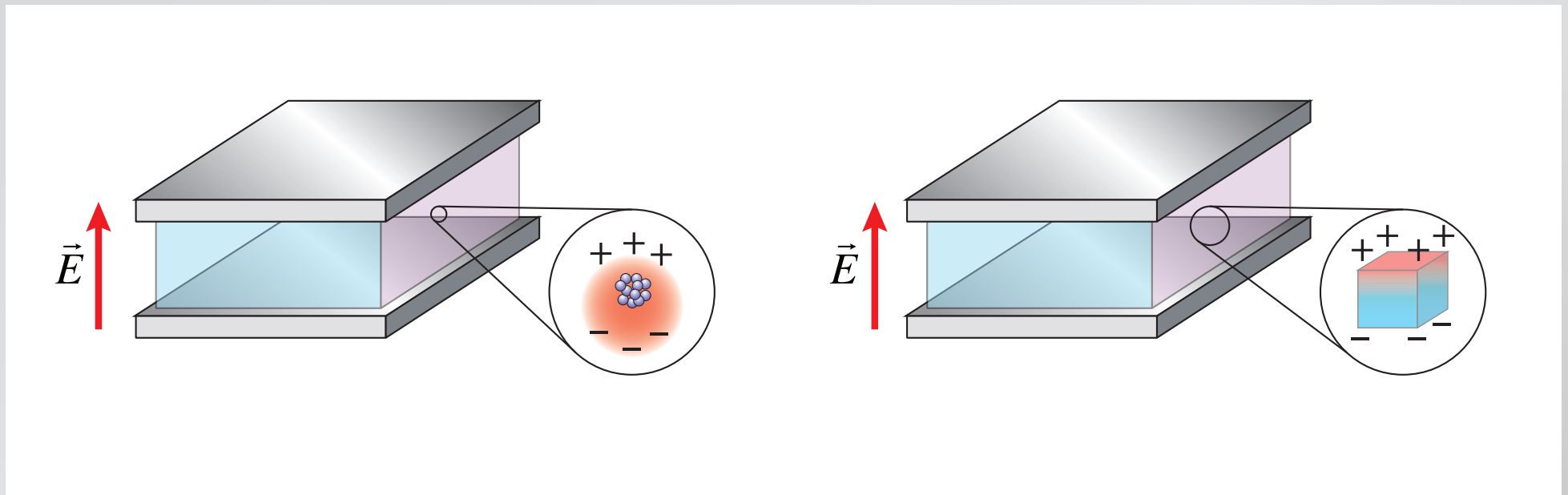

properties derive from
constituent atoms

properties derive from
constituent units

1 index

2 zero index

3 experiments

Engineering a magnetic response

use array of dielectric rods

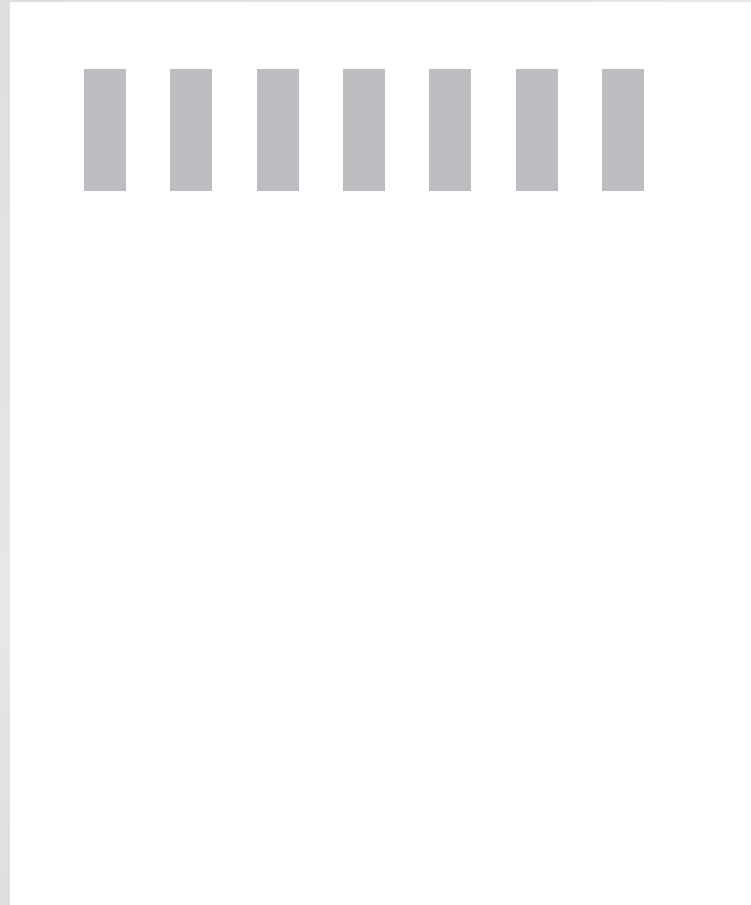

1 index

2 zero index

3 experiments

Engineering a magnetic response

incident electromagnetic wave ($\lambda_{\text{eff}} \approx a$)

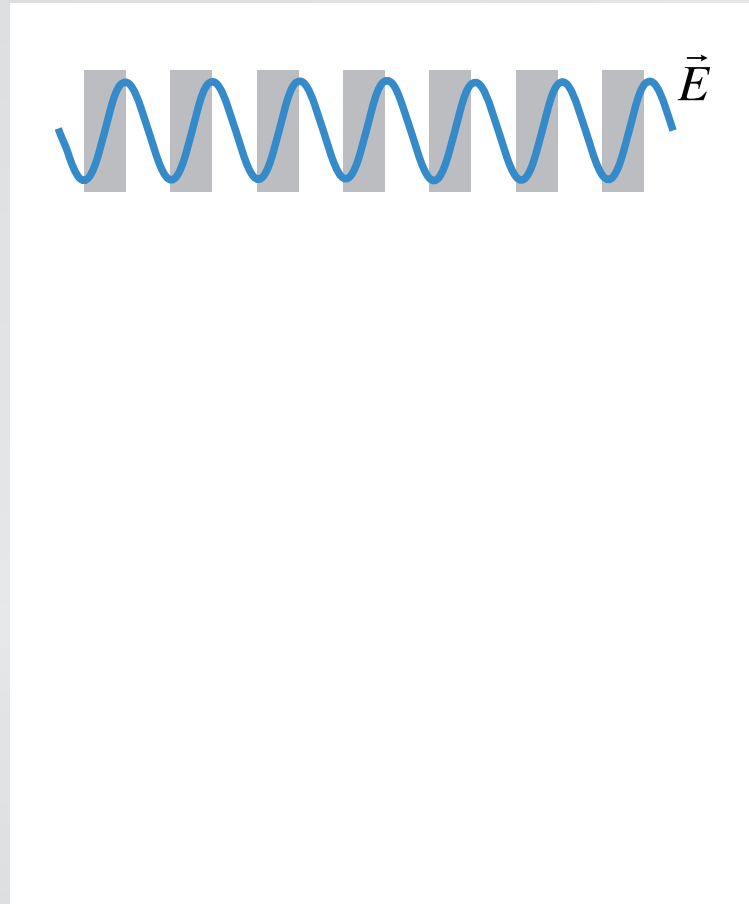

1 index

2 zero index

Engineering a magnetic response

produces an electric response...

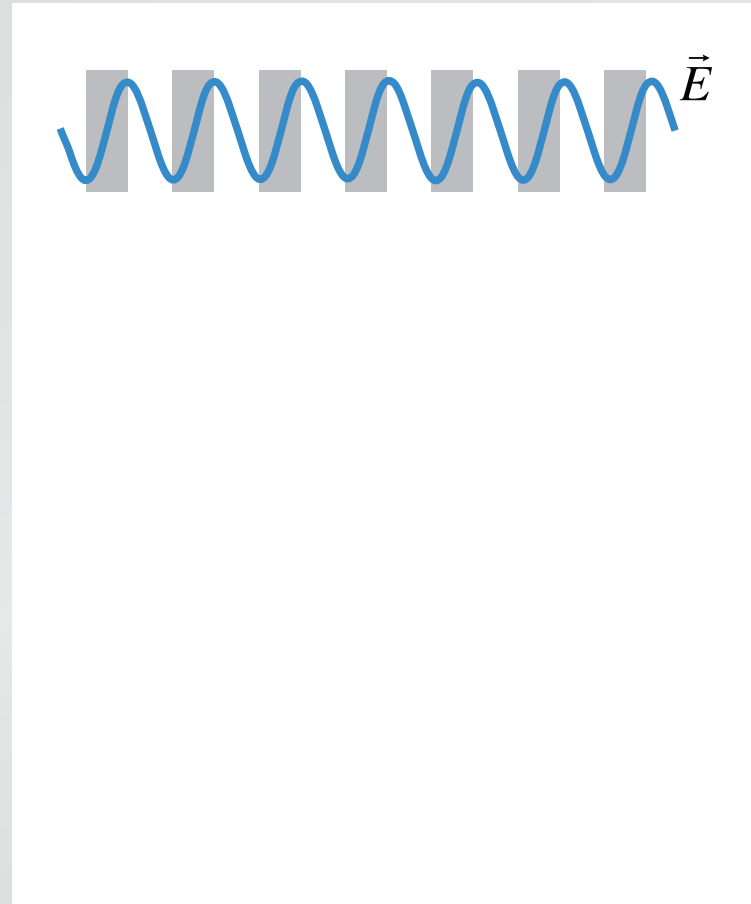

Engineering a magnetic response

... but different electric fields front and back...

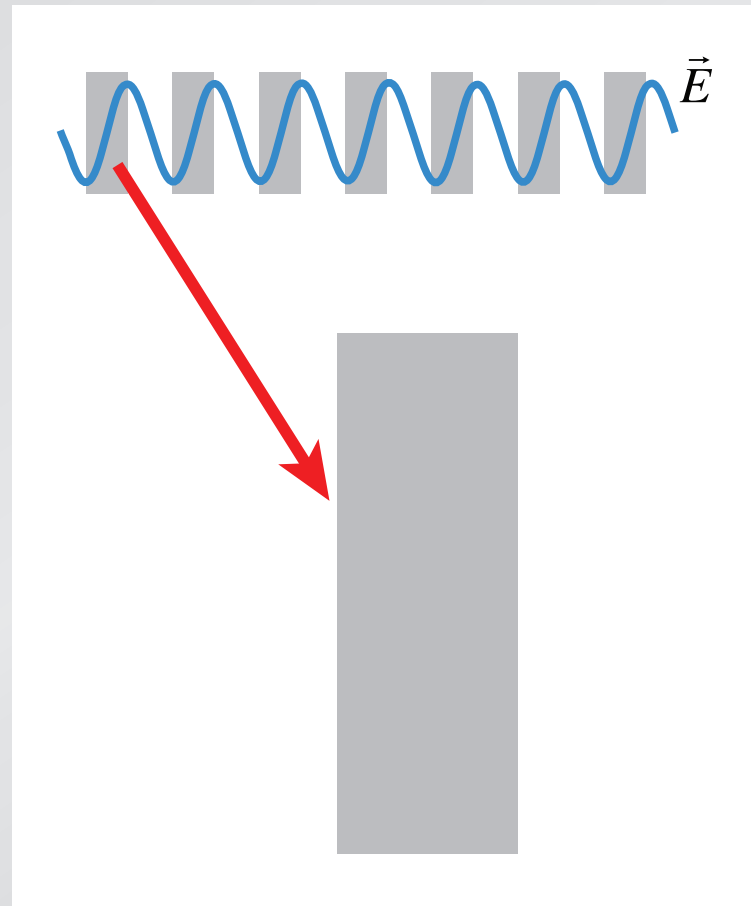

1 index

2 zero index

3 experiments

Engineering a magnetic response

...induce different polarizations on opposite sides...

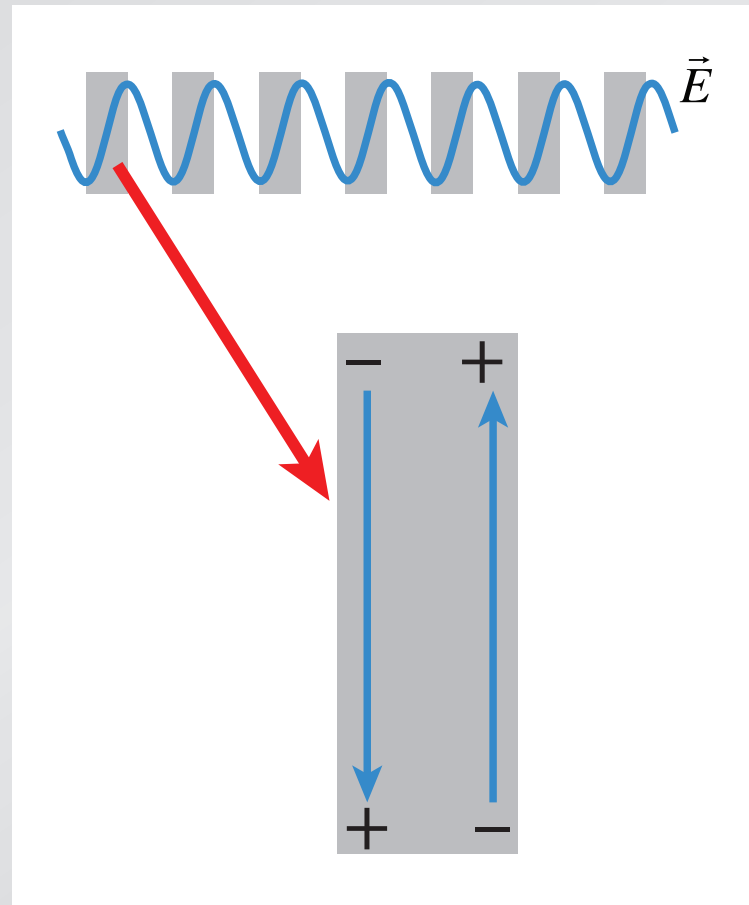

1 index

2 zero index

3 experiments

Engineering a magnetic response

...causing a current loop...

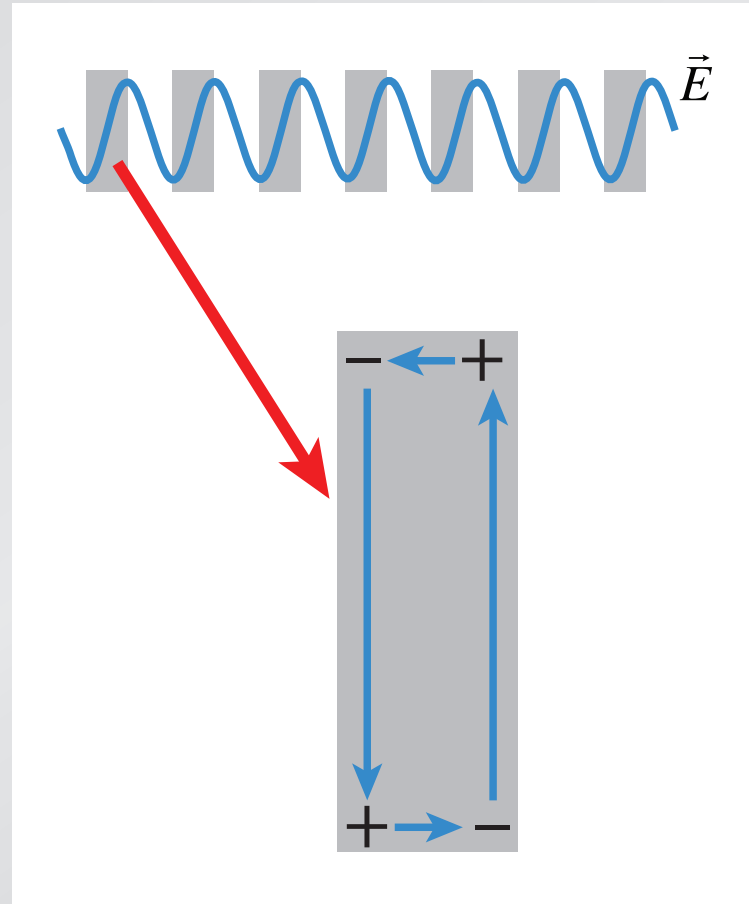

Engineering a magnetic response

...which, in turn, produces an induced magnetic field

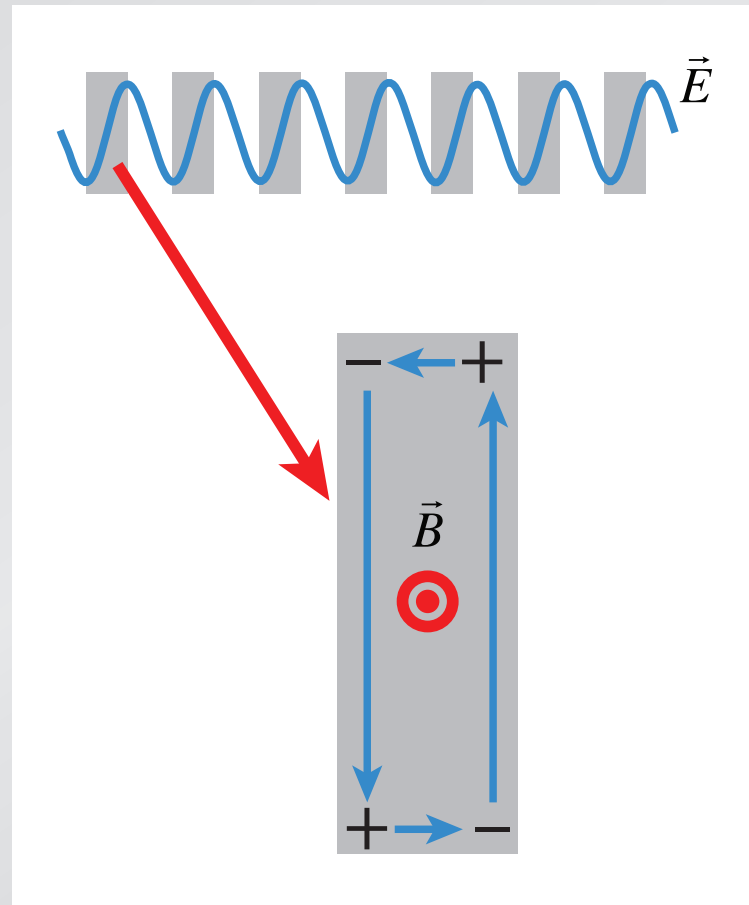

1 index

2 zero index

3 experiments

Engineering a magnetic response

adjust design so electrical and magnetic resonances coincide

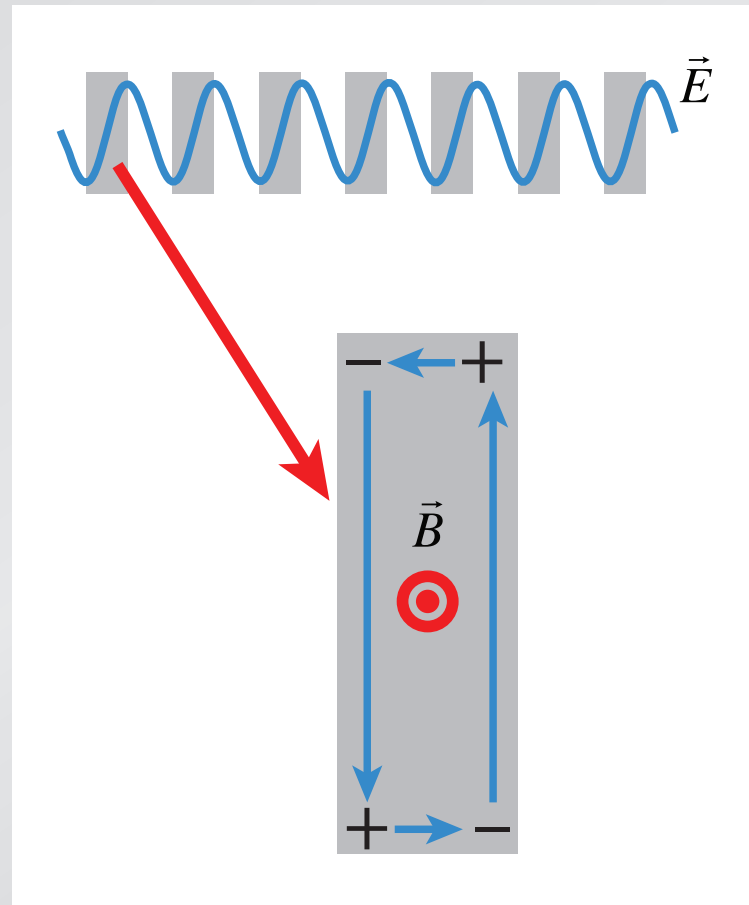

1 index

2 zero index

3 experiments

Engineering a magnetic response

adjustable parameters



1 index

2 zero index

3 experiments

Engineering a magnetic response

adjustable parameters

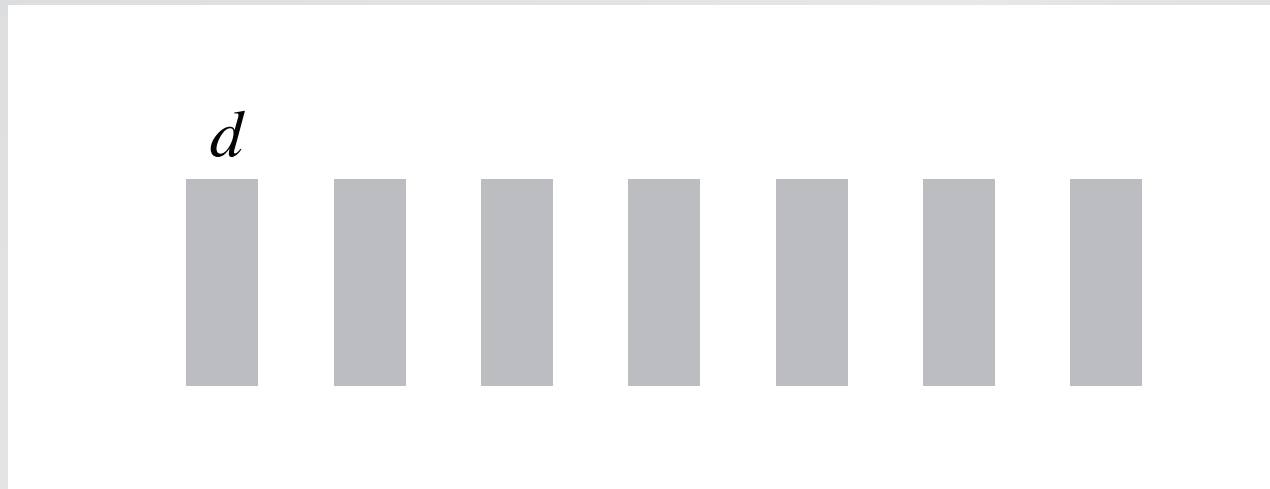

1 index

2 zero index

3 experiments

Engineering a magnetic response

adjustable parameters

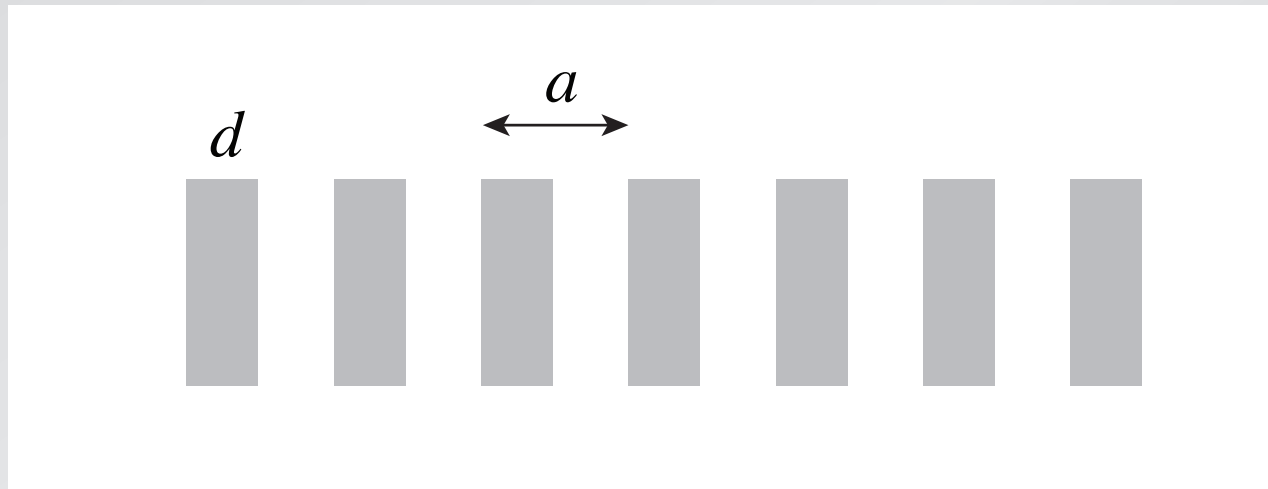

1 index

2 zero index

3 experiments

Engineering a magnetic response

adjustable parameters

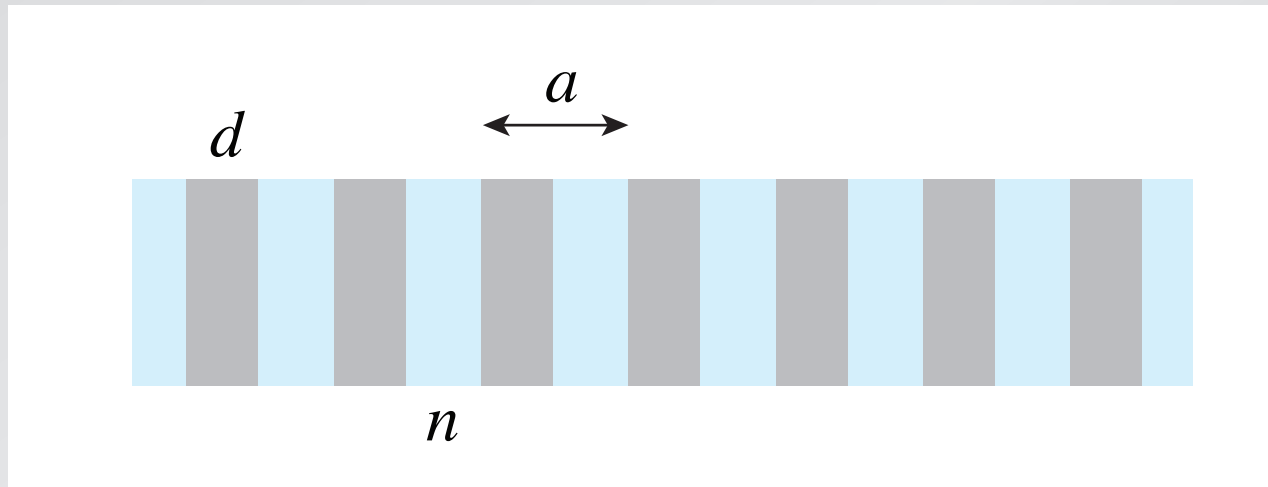

1 index

2 zero index

3 experiments

Engineering a magnetic response

adjustable parameters

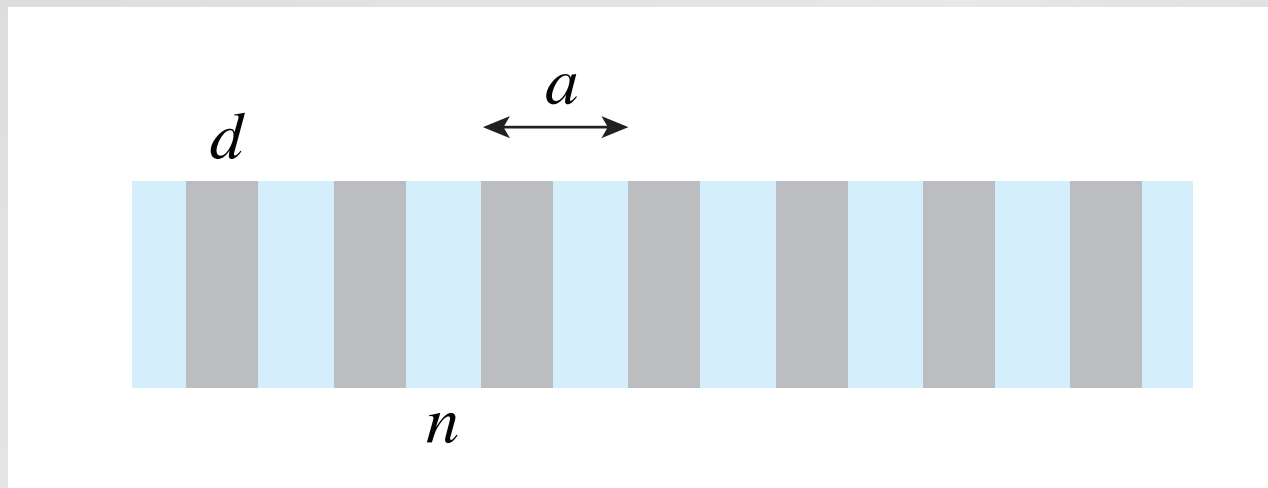

$$d = 422 \text{ nm}, \quad a = 690 \text{ nm}, \quad n = 1.57 \text{ (SU8)}$$

1 index

2 zero index

3 experiments

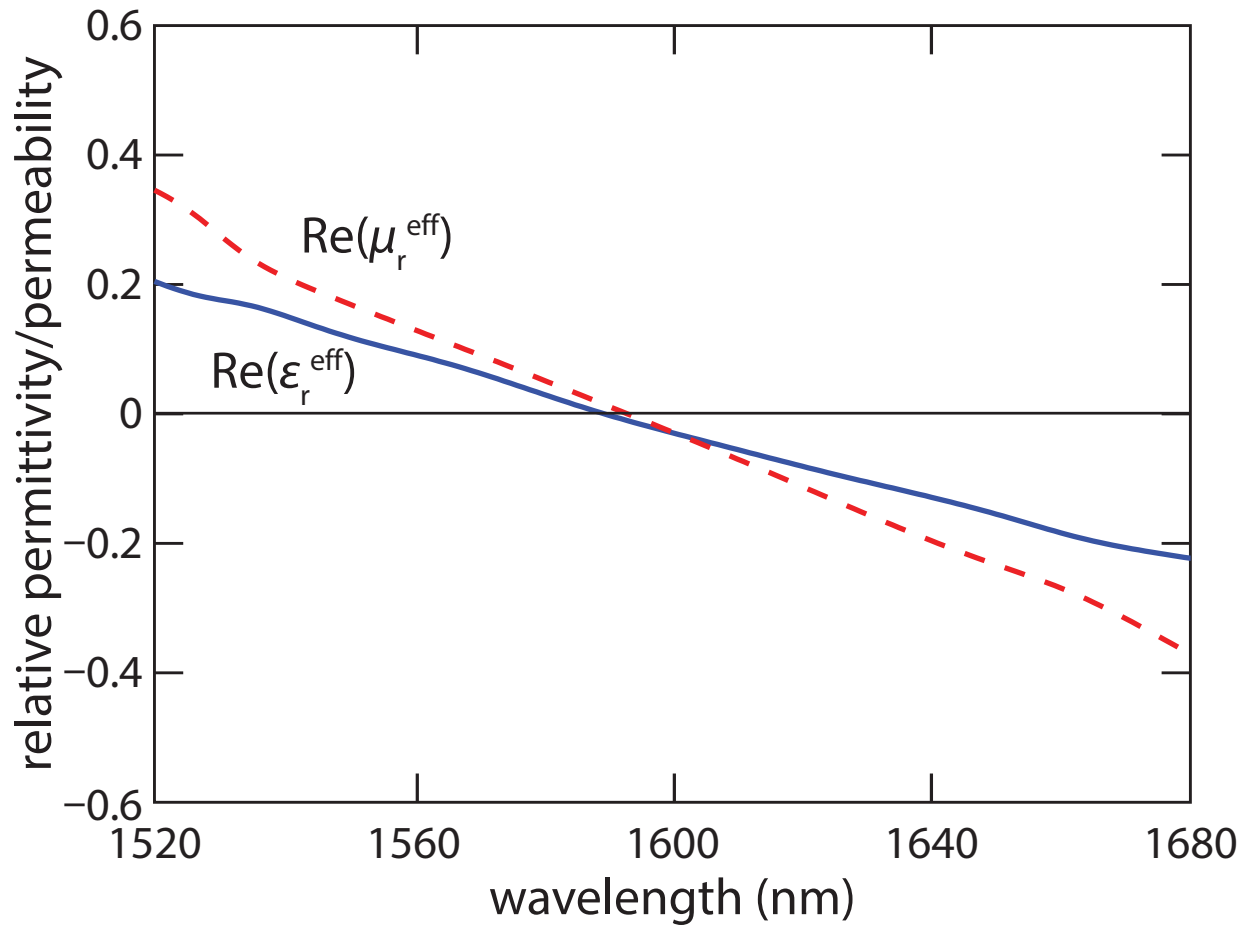

1 index

2 zero index

3 experiments

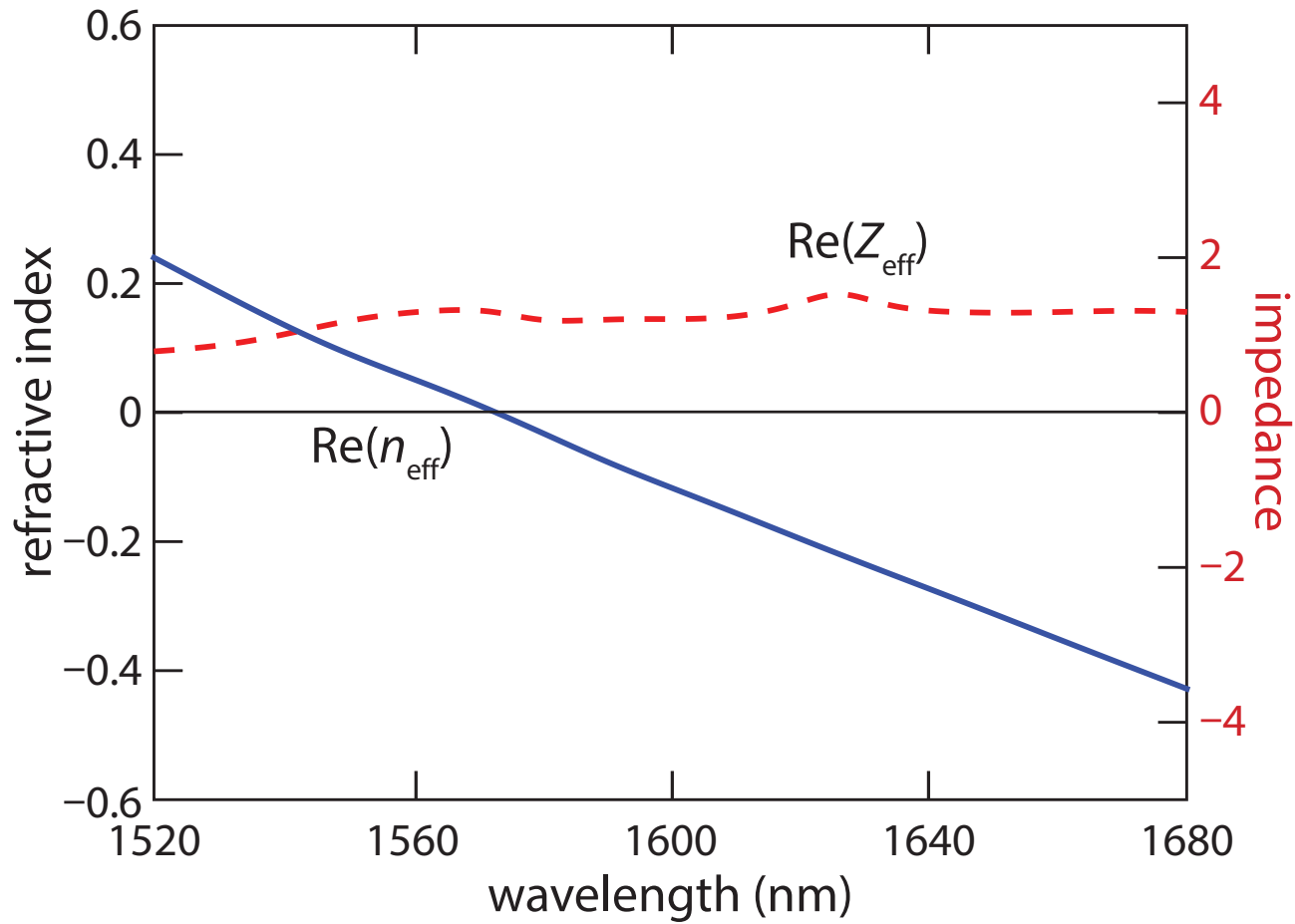

1 index

2 zero index

3 experiments

at design wavelength (1590 nm)

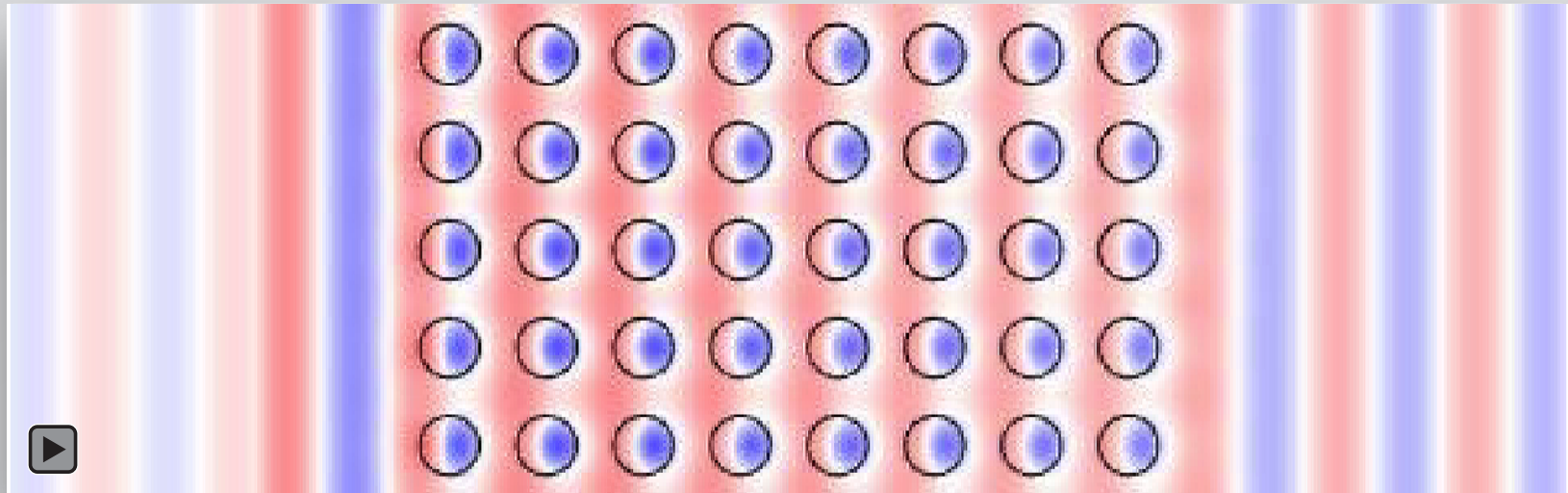

1 index

2 zero index

3 experiments

below design wavelength (1530 nm)

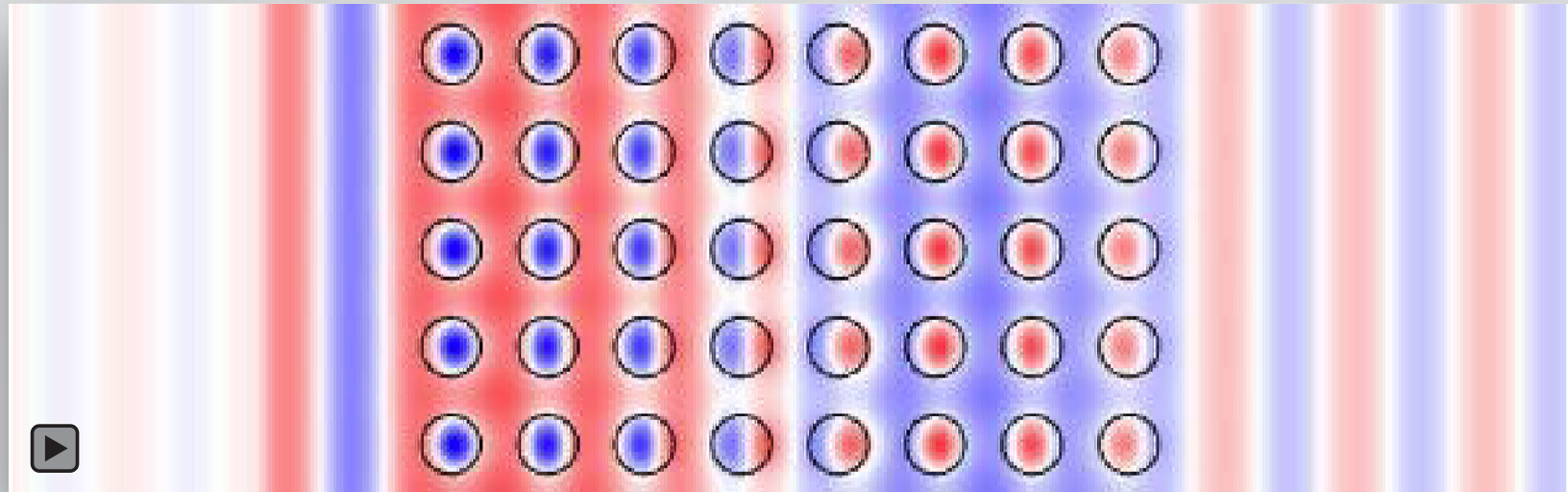

1 index

2 zero index

3 experiments

above design wavelength (1650 nm)

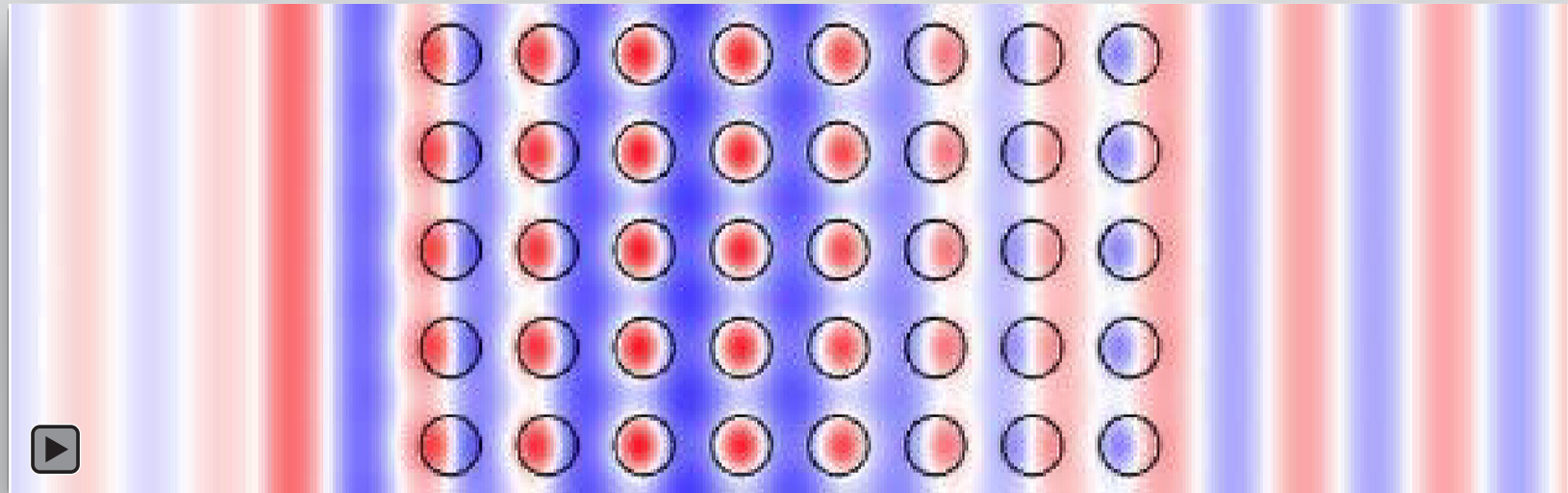

1 index

2 zero index

3 experiments

How to fabricate?

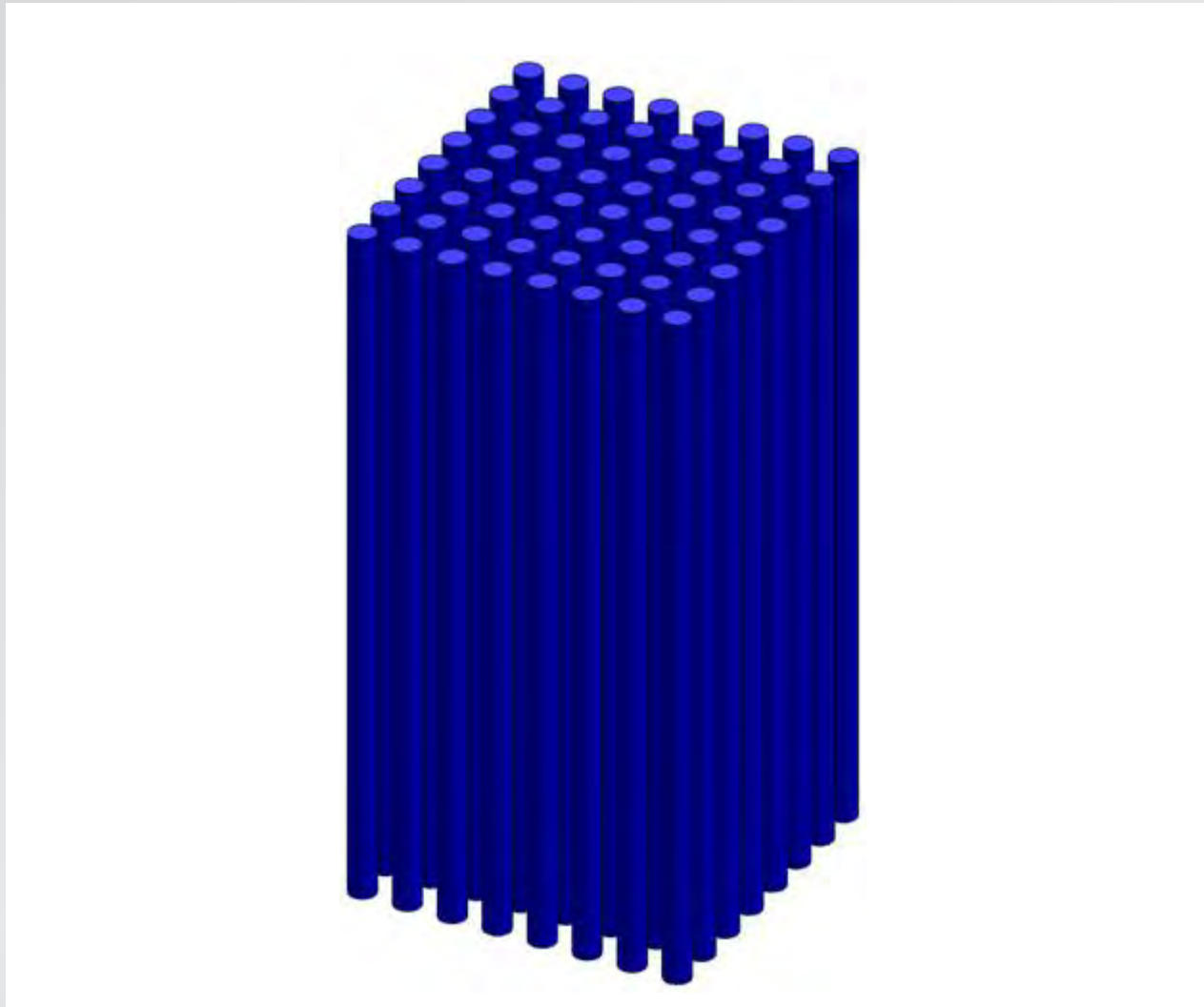

1 index

2 zero index

3 experiments

On-chip zero-index fabrication



1 index

2 zero index

3 experiments

On-chip zero-index fabrication

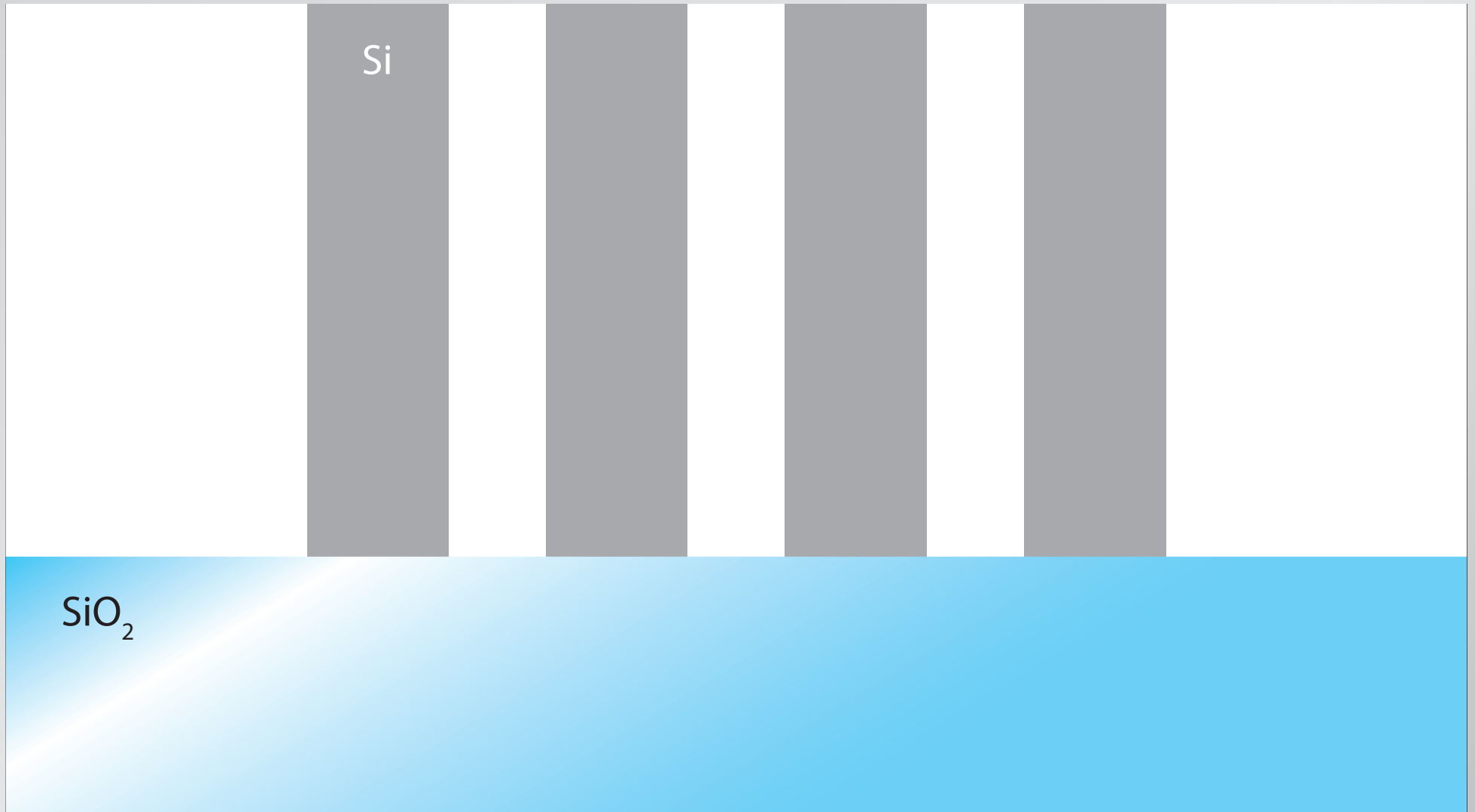

① index

② zero index

③ experiments

On-chip zero-index fabrication



1 index

2 zero index

3 experiments

On-chip zero-index fabrication

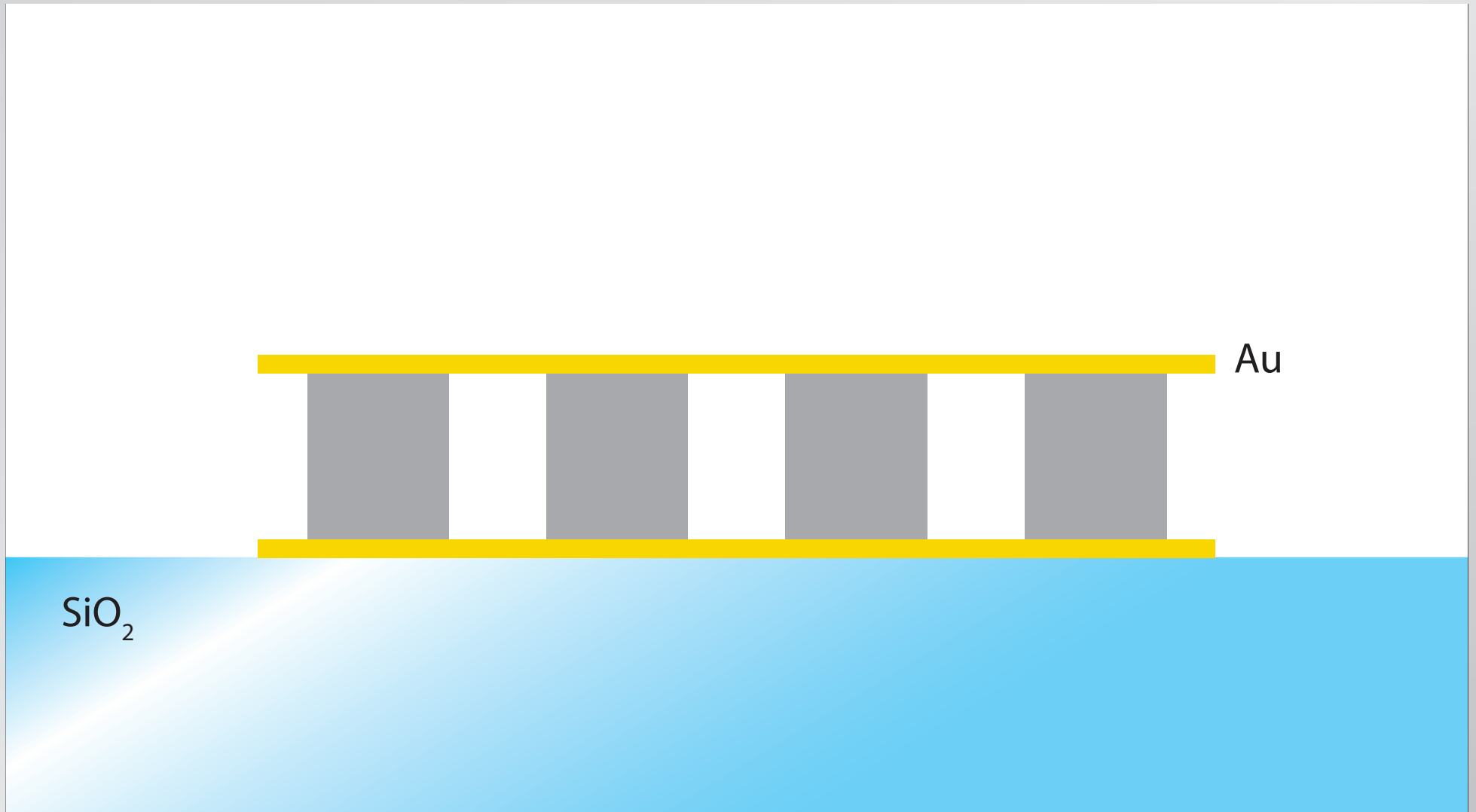

① index

② zero index

③ experiments

On-chip zero-index fabrication

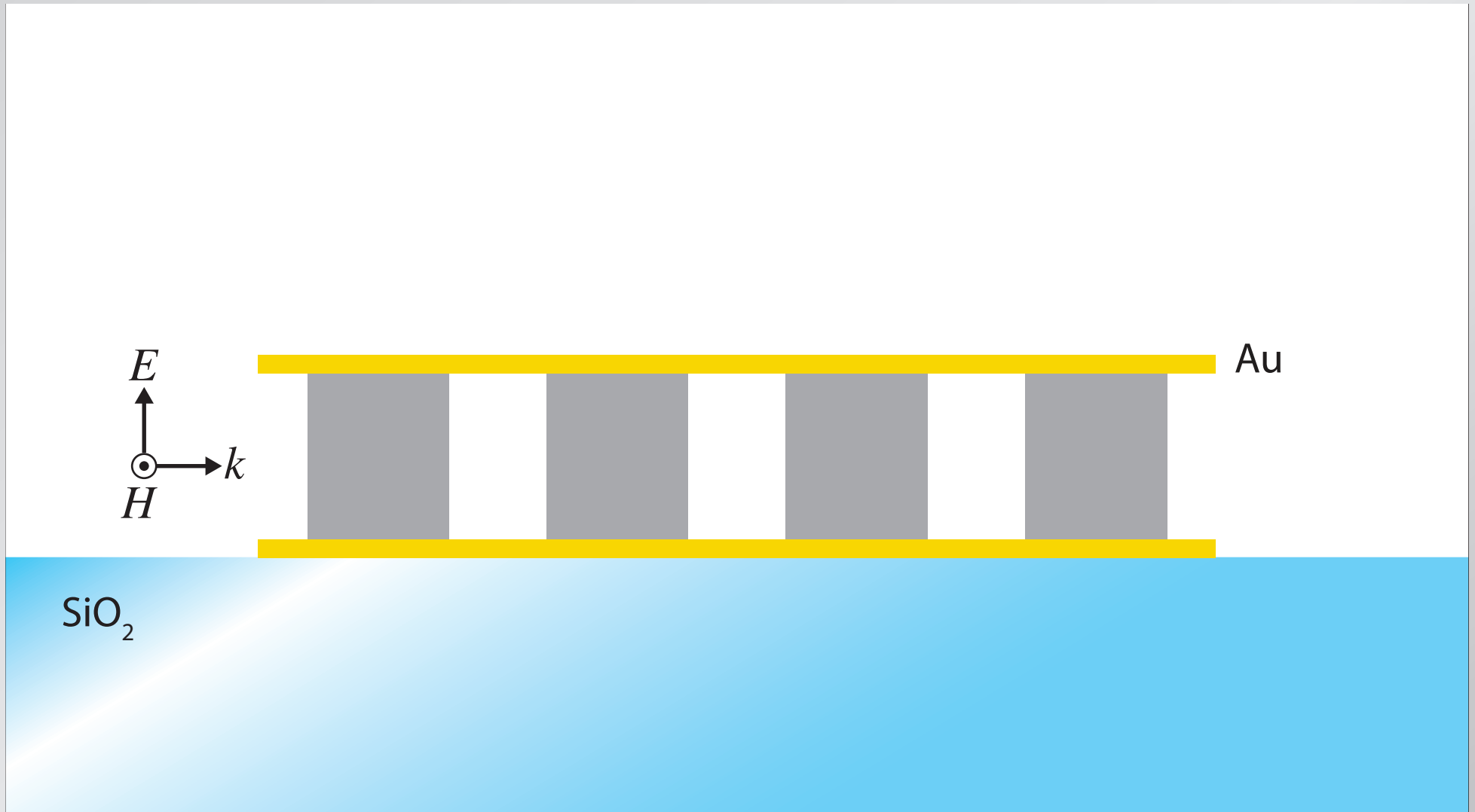

1 index

2 zero index

3 experiments

On-chip zero-index fabrication

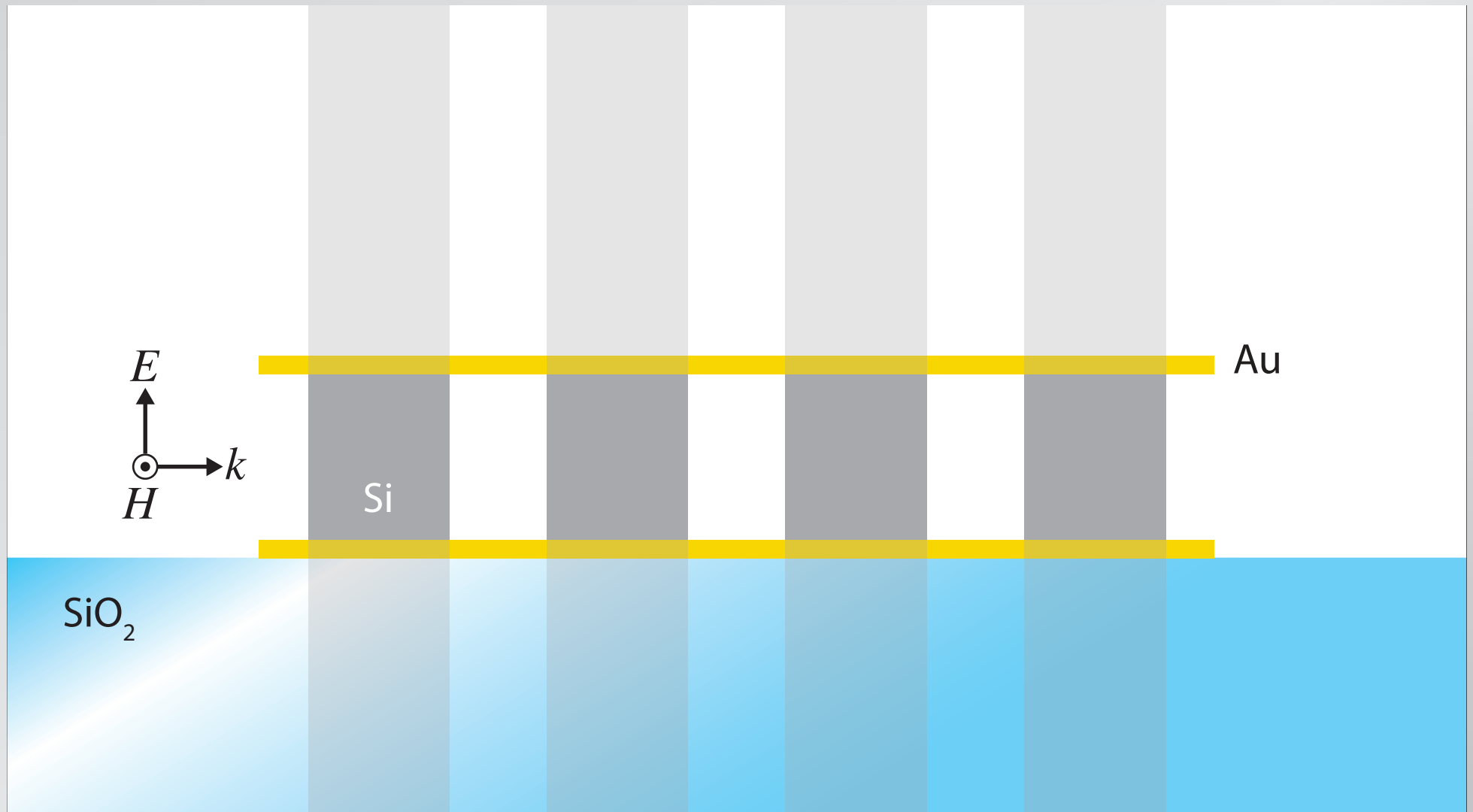

1 index

2 zero index

3 experiments

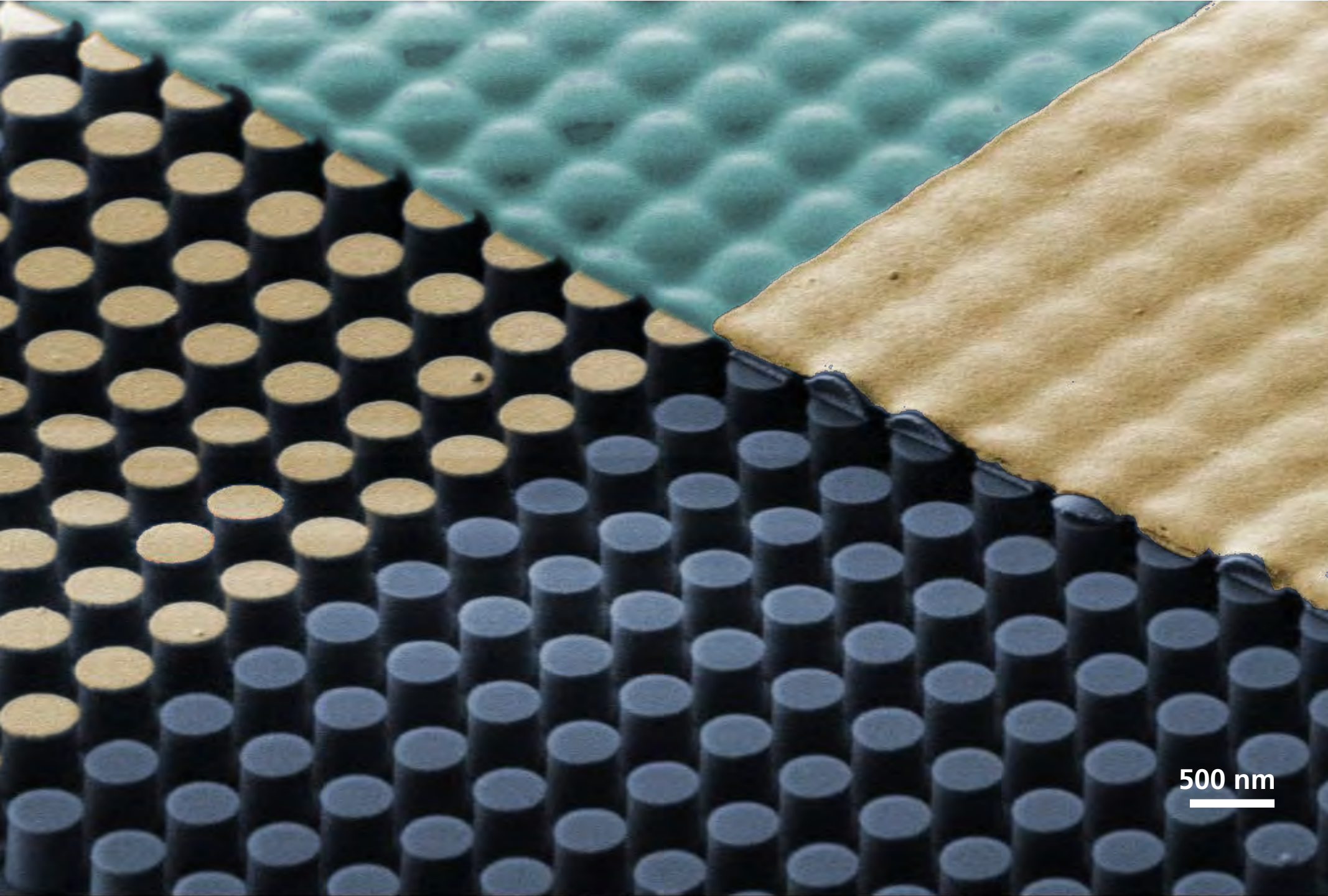

500 nm

1 index

2 zero index

3 experiments

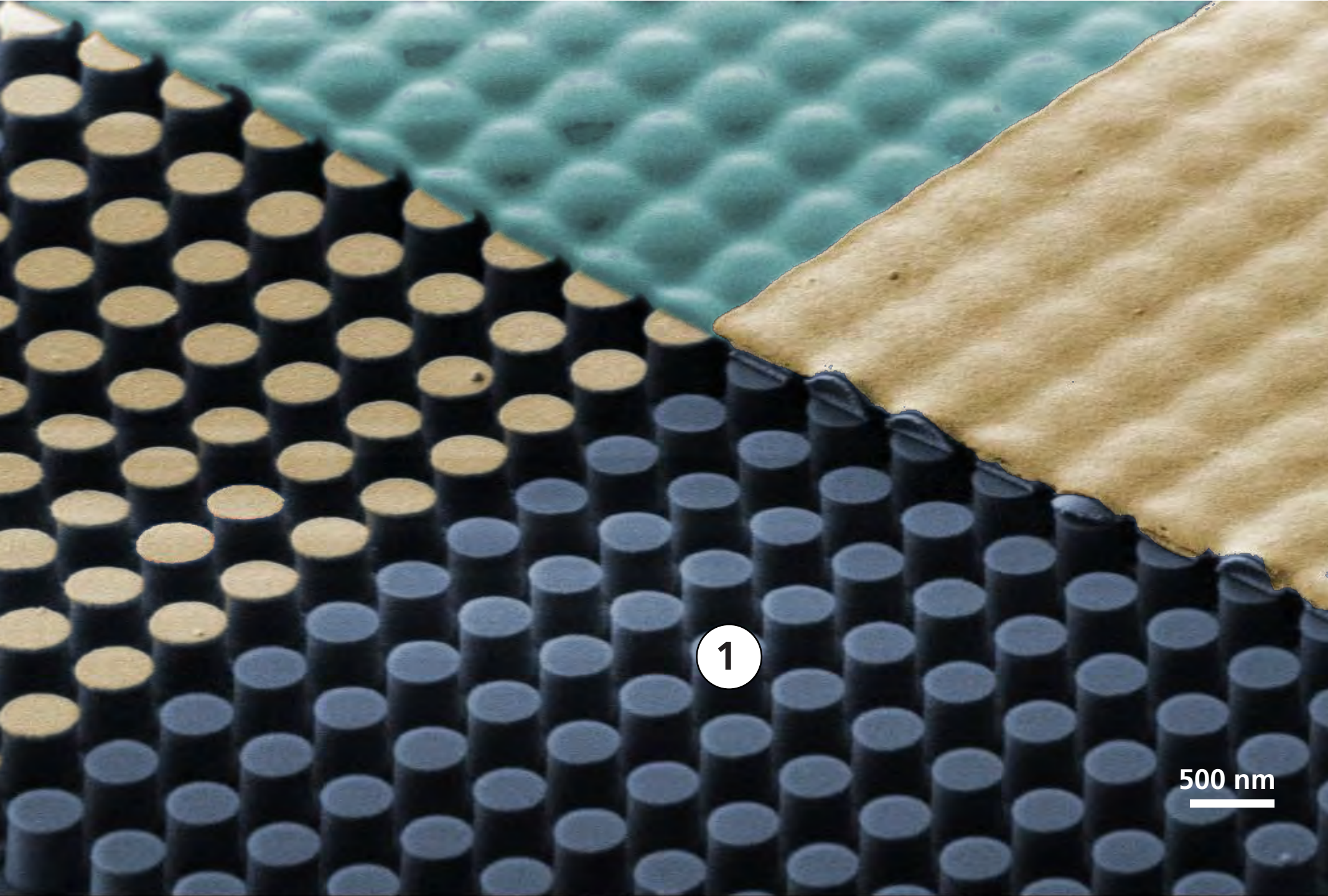

1 index

2 zero index

3 experiments

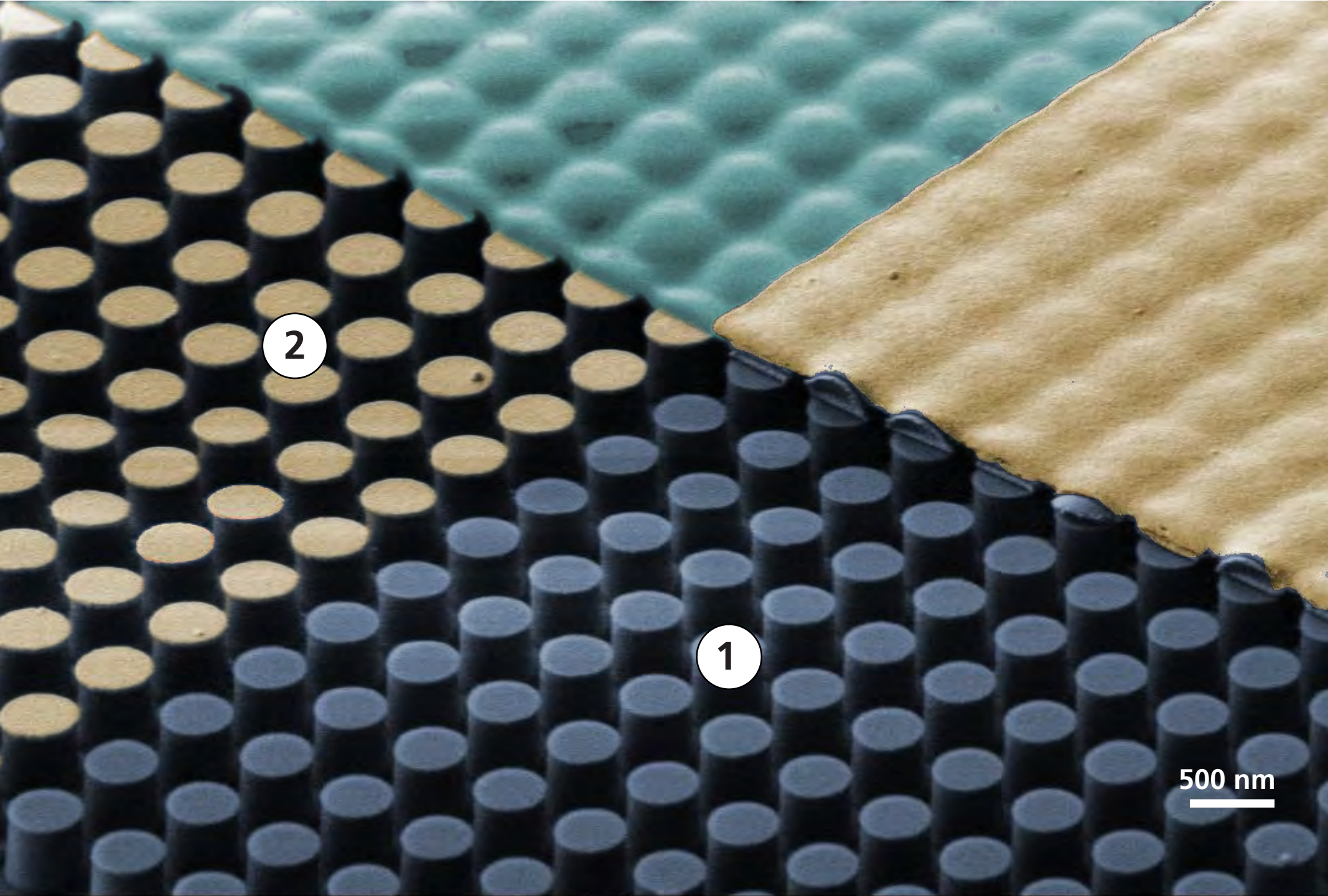

1 index

2 zero index

3 experiments

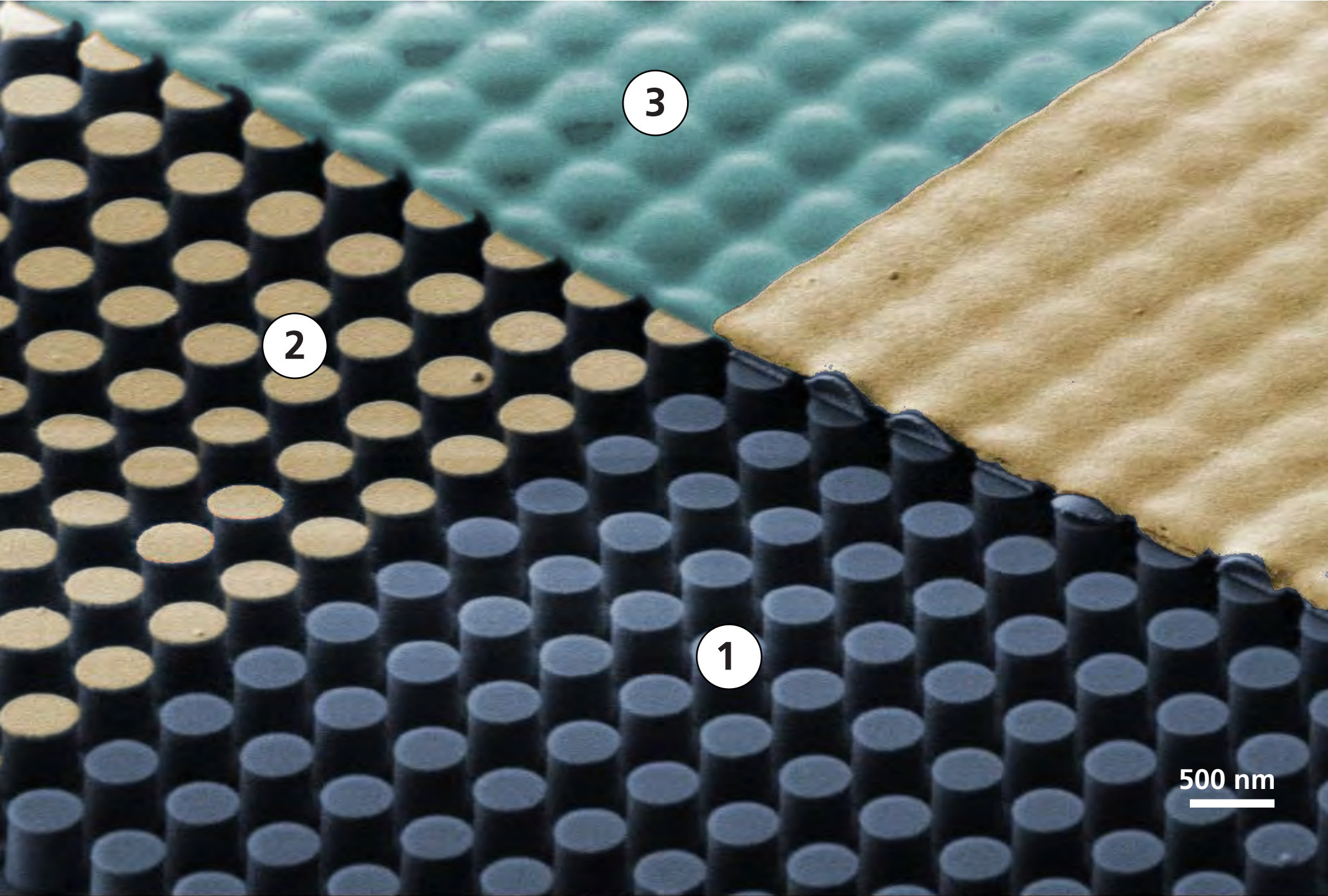

500 nm

1 index

2 zero index

3 experiments

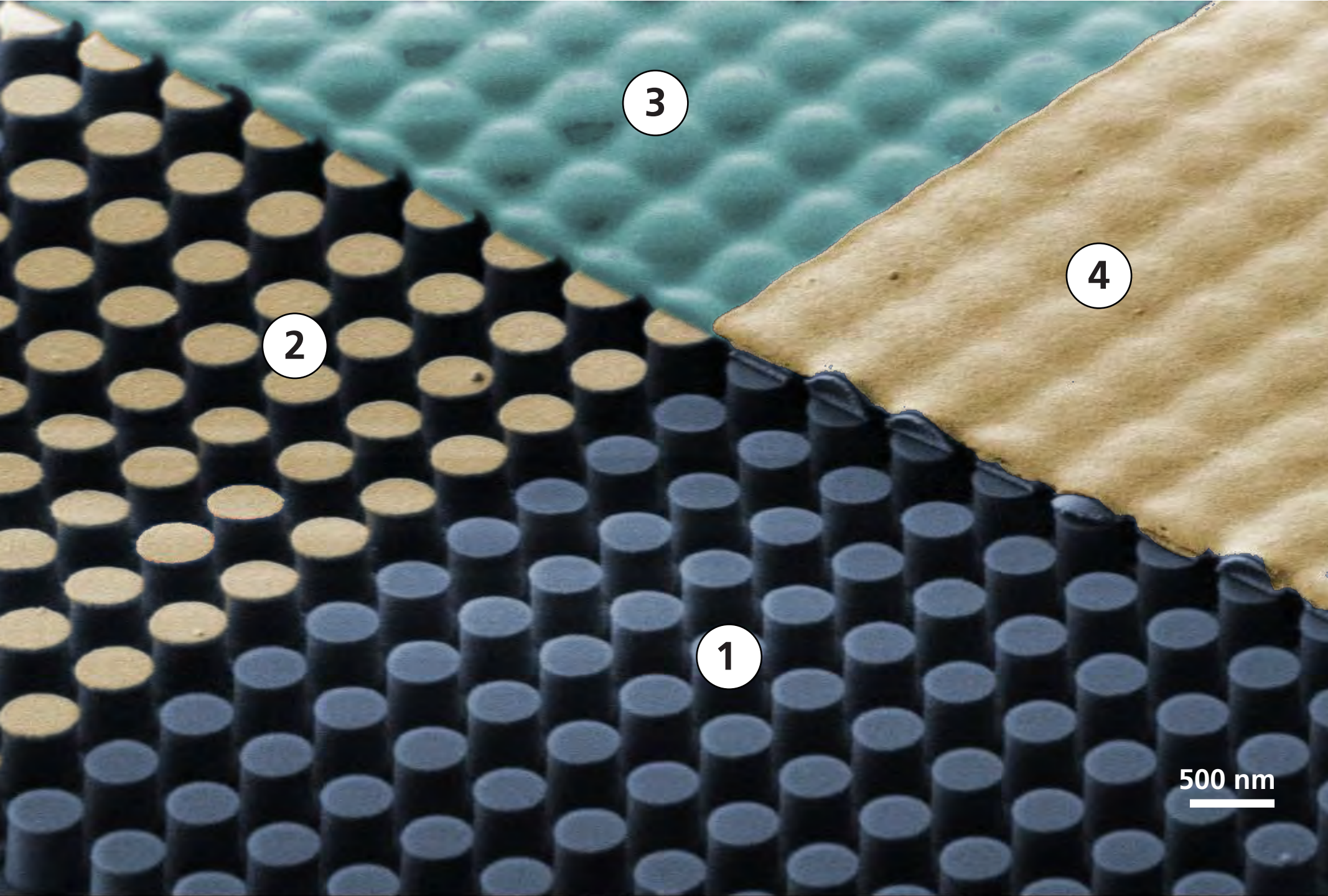

1 index

2 zero index

3 experiments

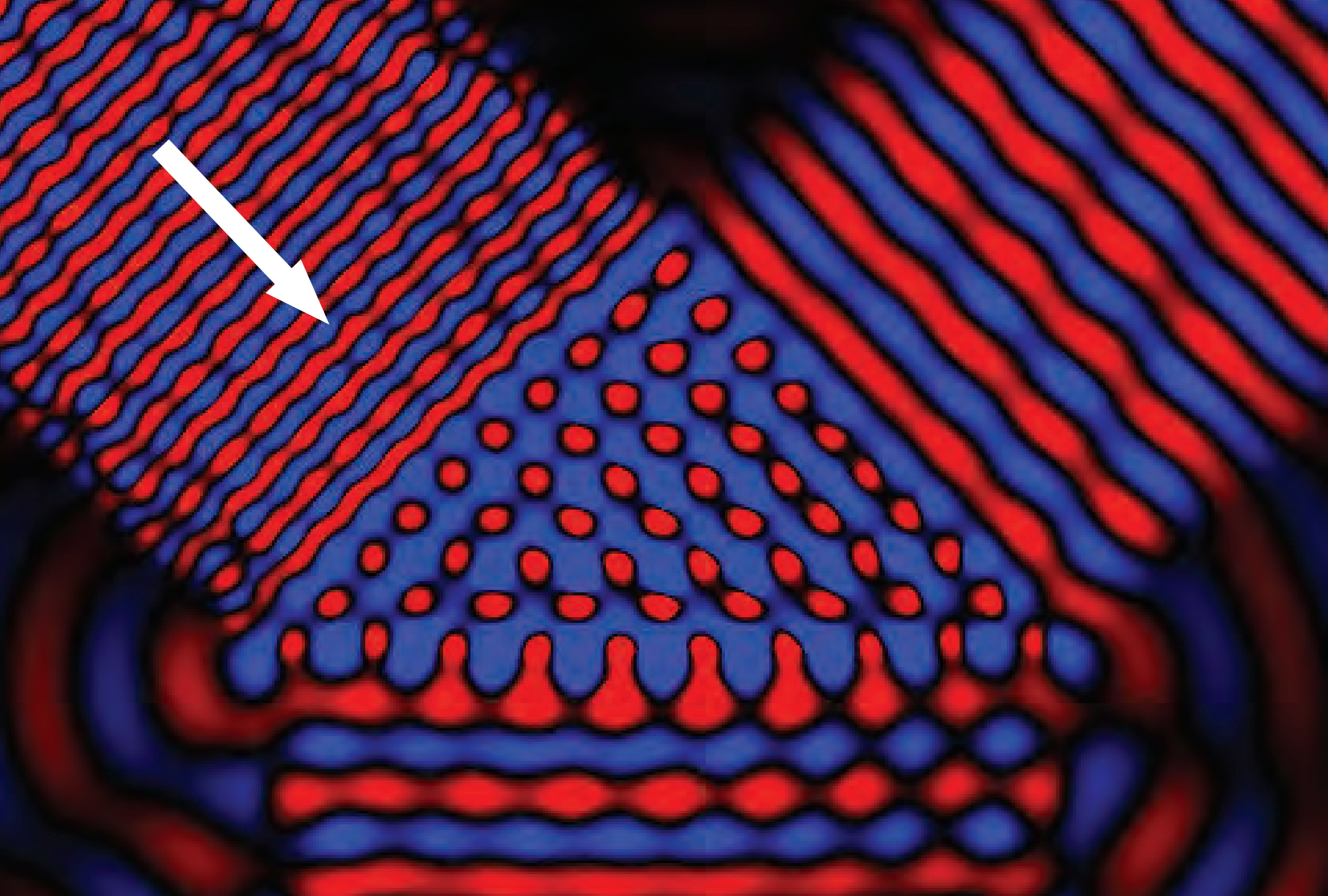

1 index

2 zero index

3 experiments

On-chip zero-index prism



1 index

2 zero index

3 experiments

On-chip zero-index prism

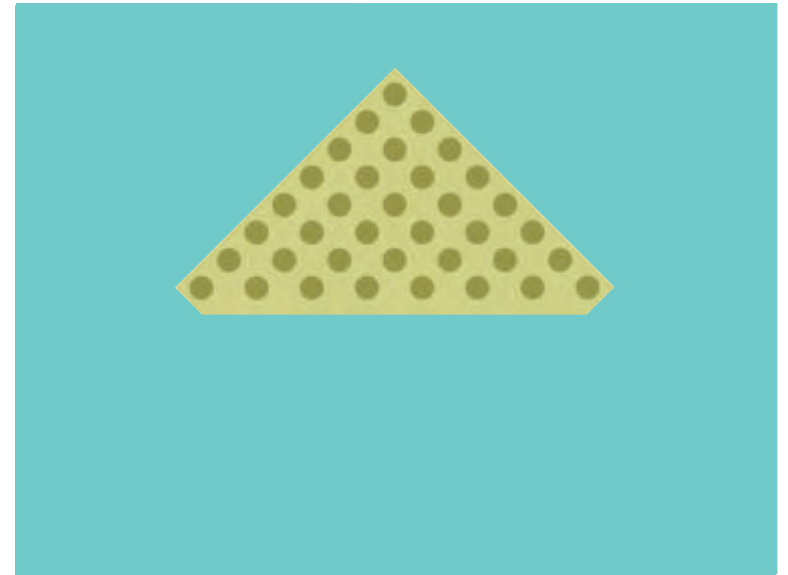

1 index

2 zero index

3 experiments

On-chip zero-index prism

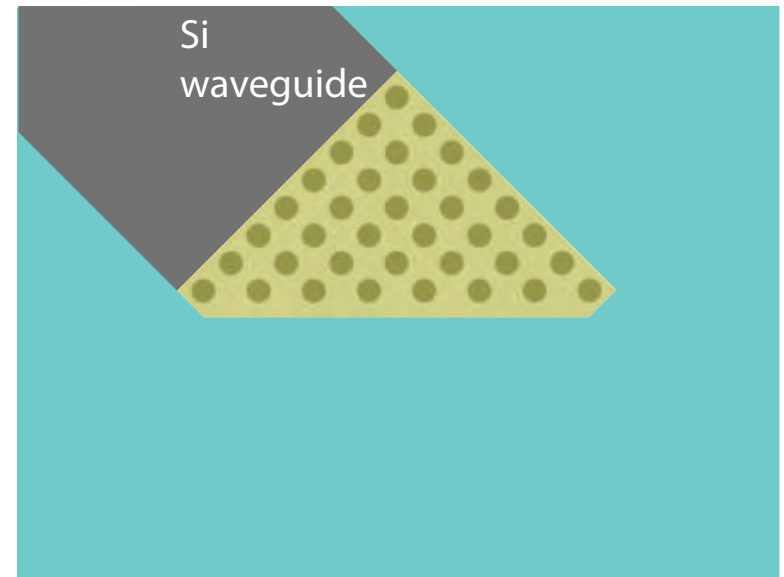

1 index

2 zero index

3 experiments

On-chip zero-index prism

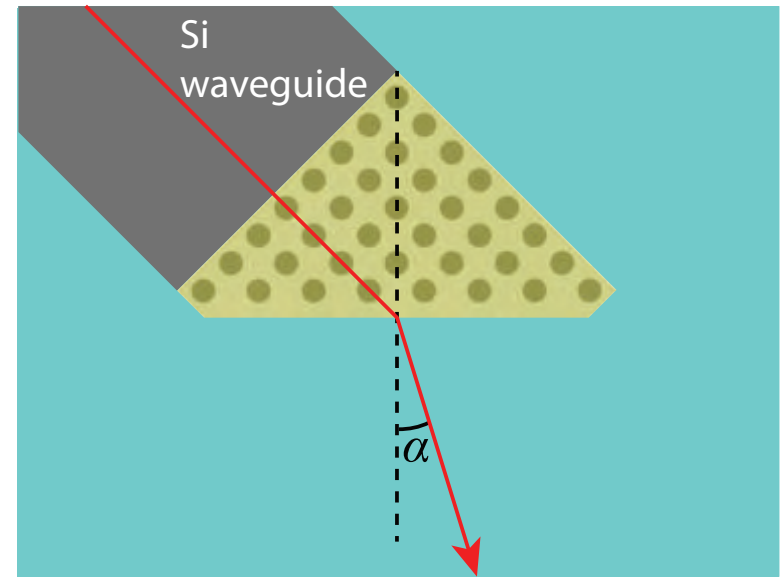

1 index

2 zero index

3 experiments

On-chip zero-index prism

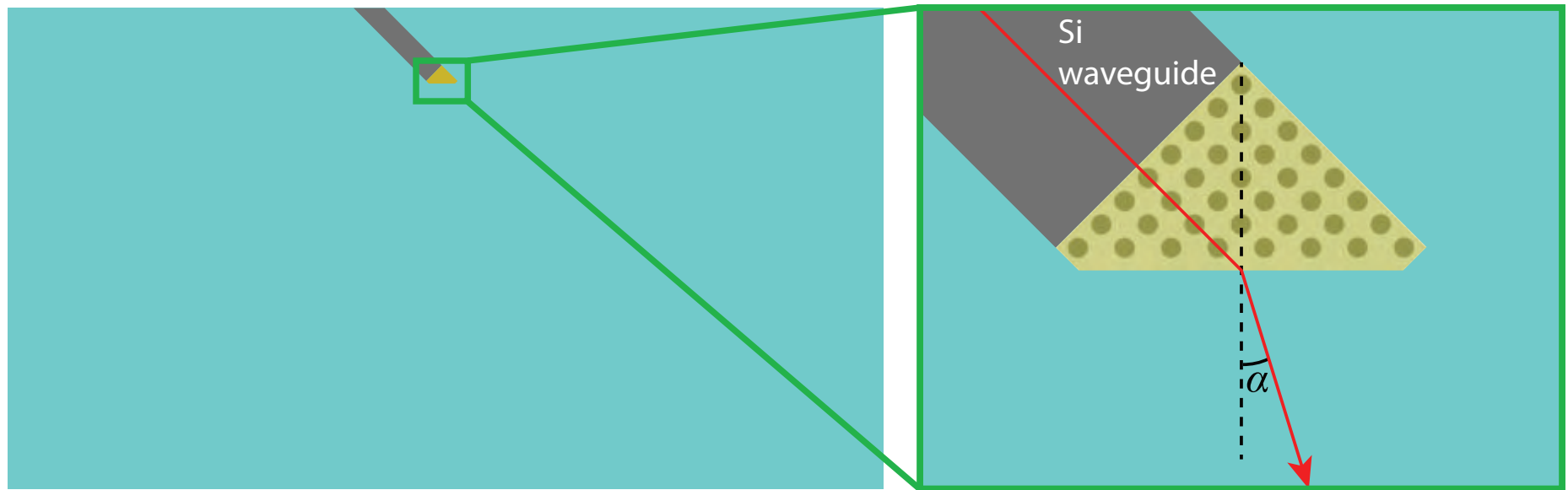

1 index

2 zero index

3 experiments

On-chip zero-index prism

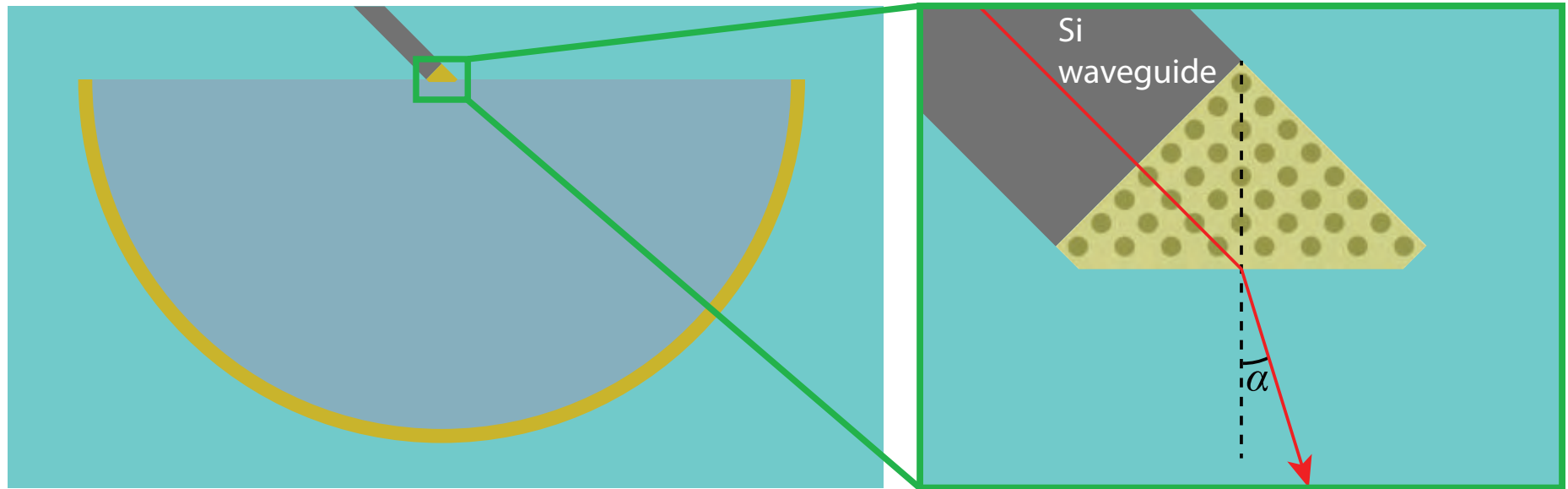

1 index

2 zero index

3 experiments

On-chip zero-index prism

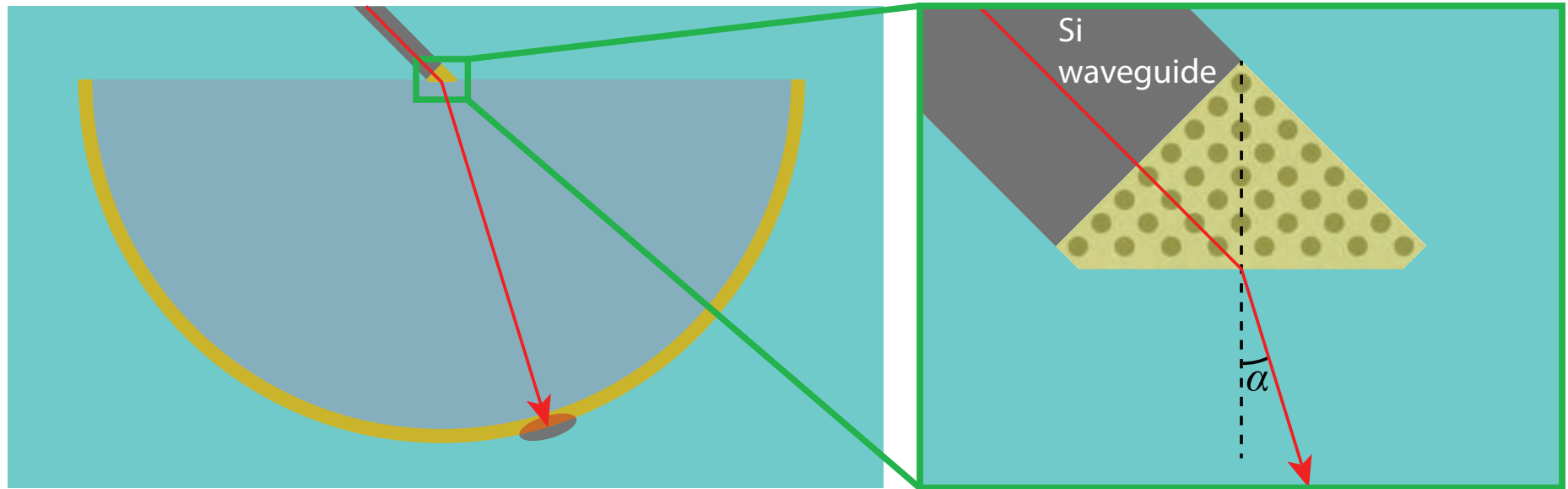

1 index

2 zero index

3 experiments

On-chip zero-index prism

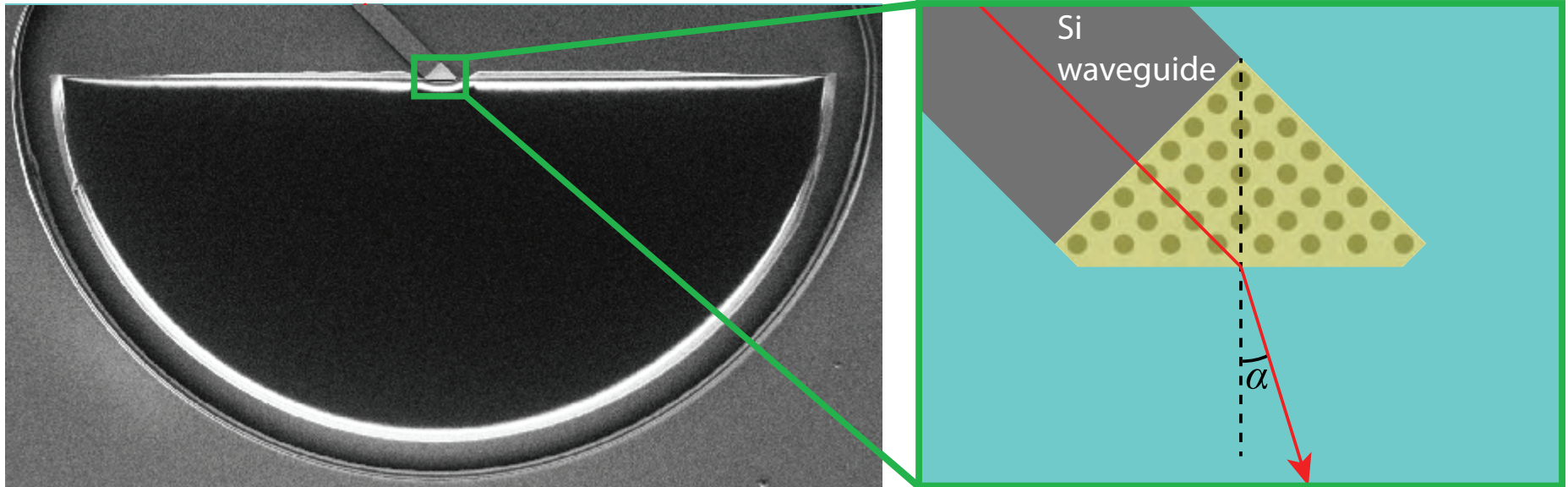

1 index

2 zero index

3 experiments

On-chip zero-index prism

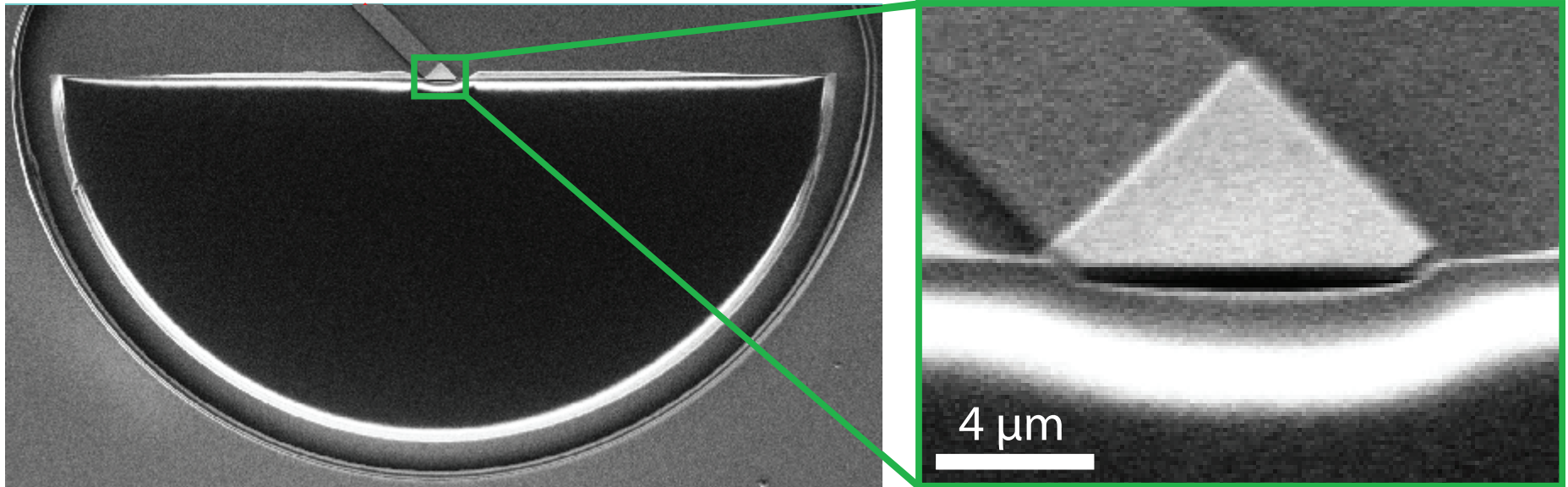

1 index

2 zero index

3 experiments

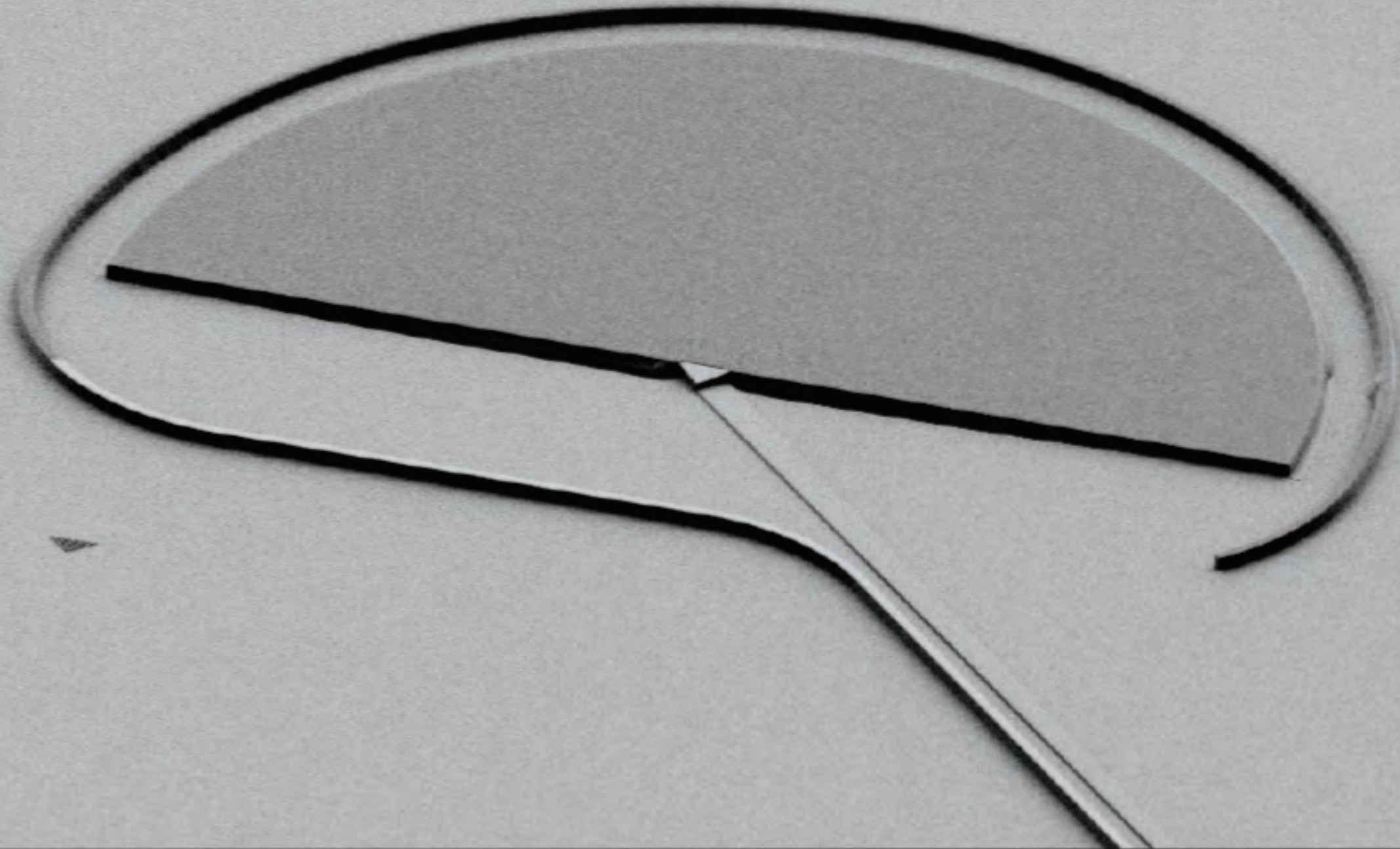

1 index

2 zero index

3 experiments

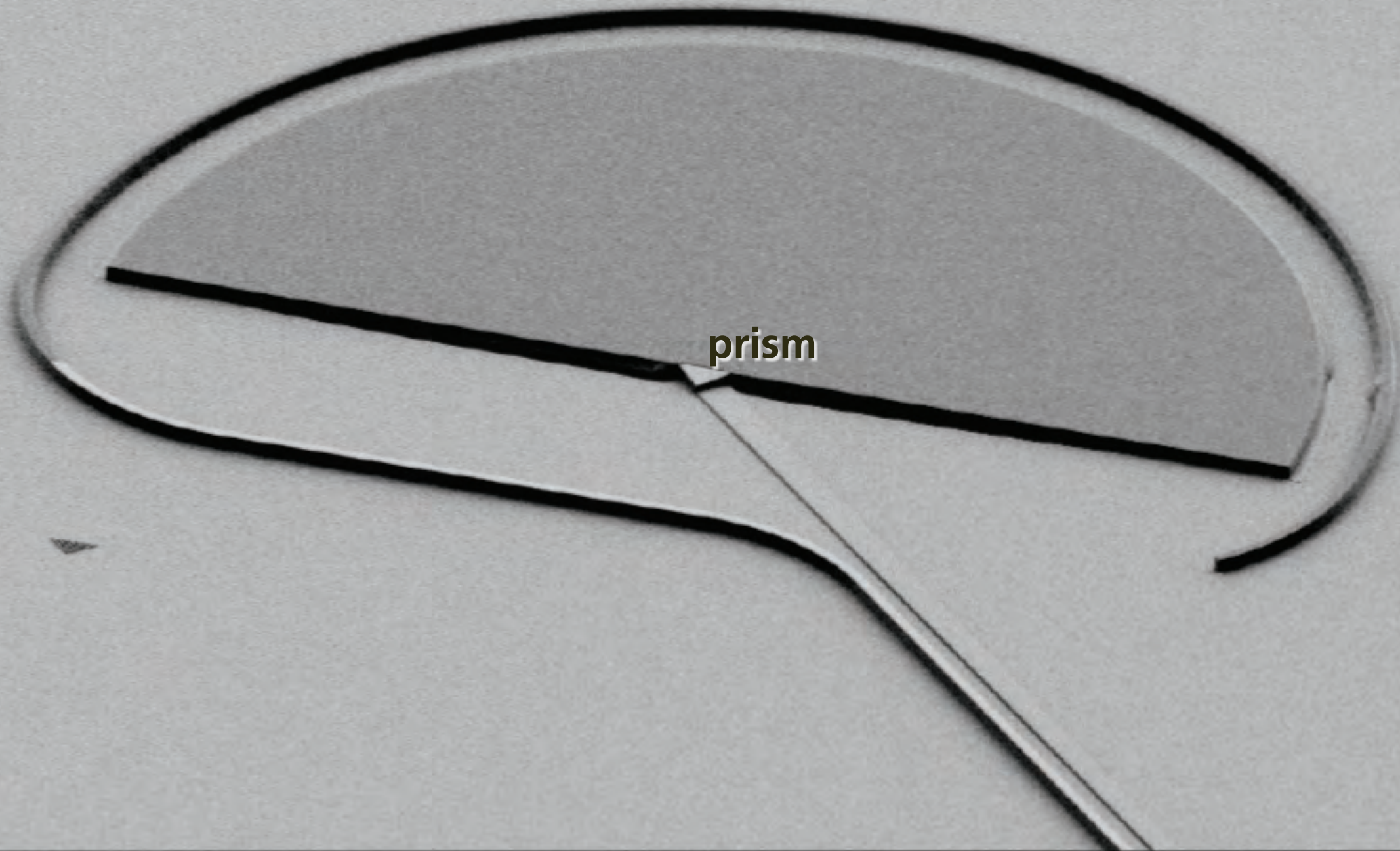

1 index

2 zero index

3 experiments

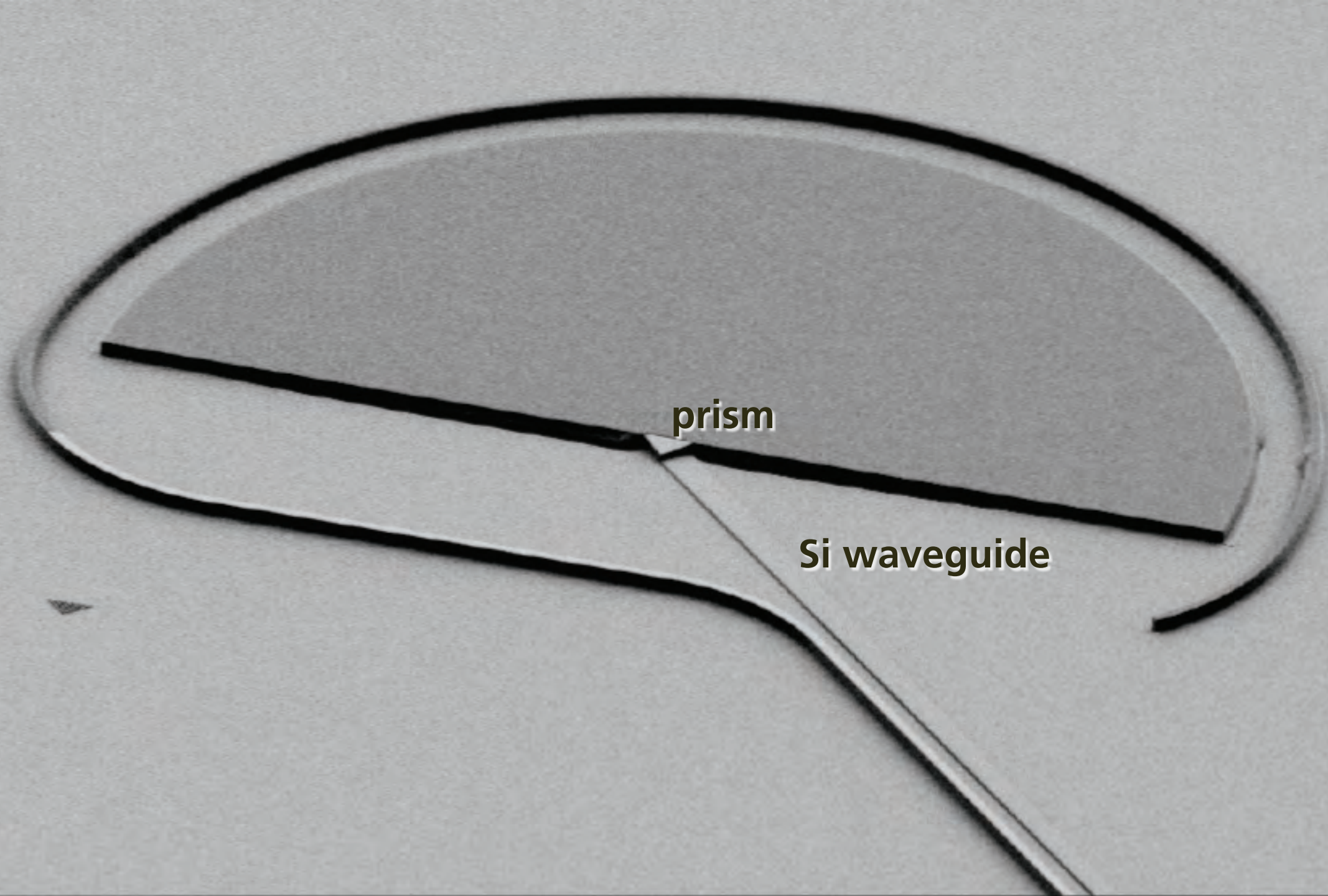

prism

Si waveguide

1 index

2 zero index

3 experiments

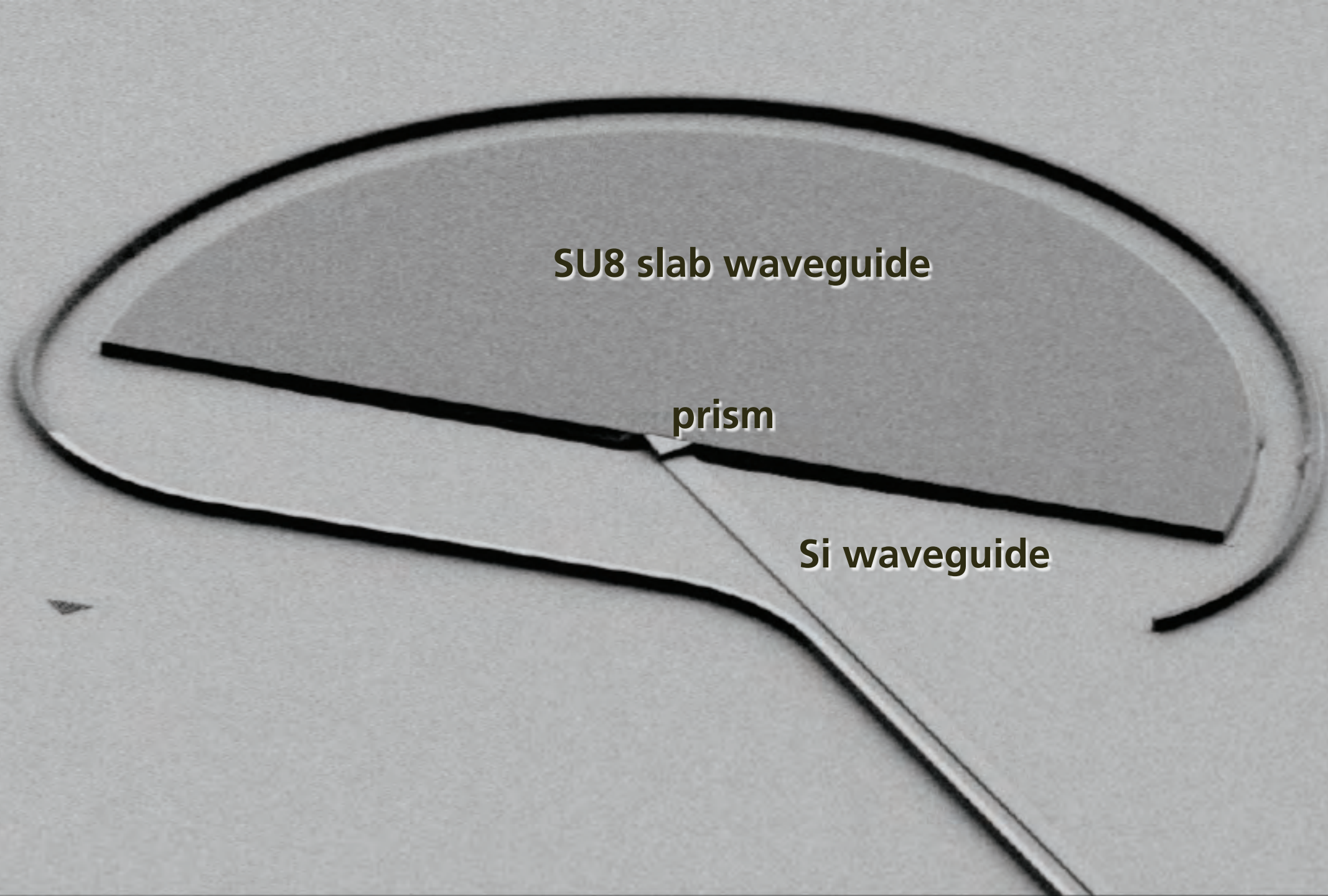

SU8 slab waveguide

prism

Si waveguide

1 index

2 zero index

3 experiments

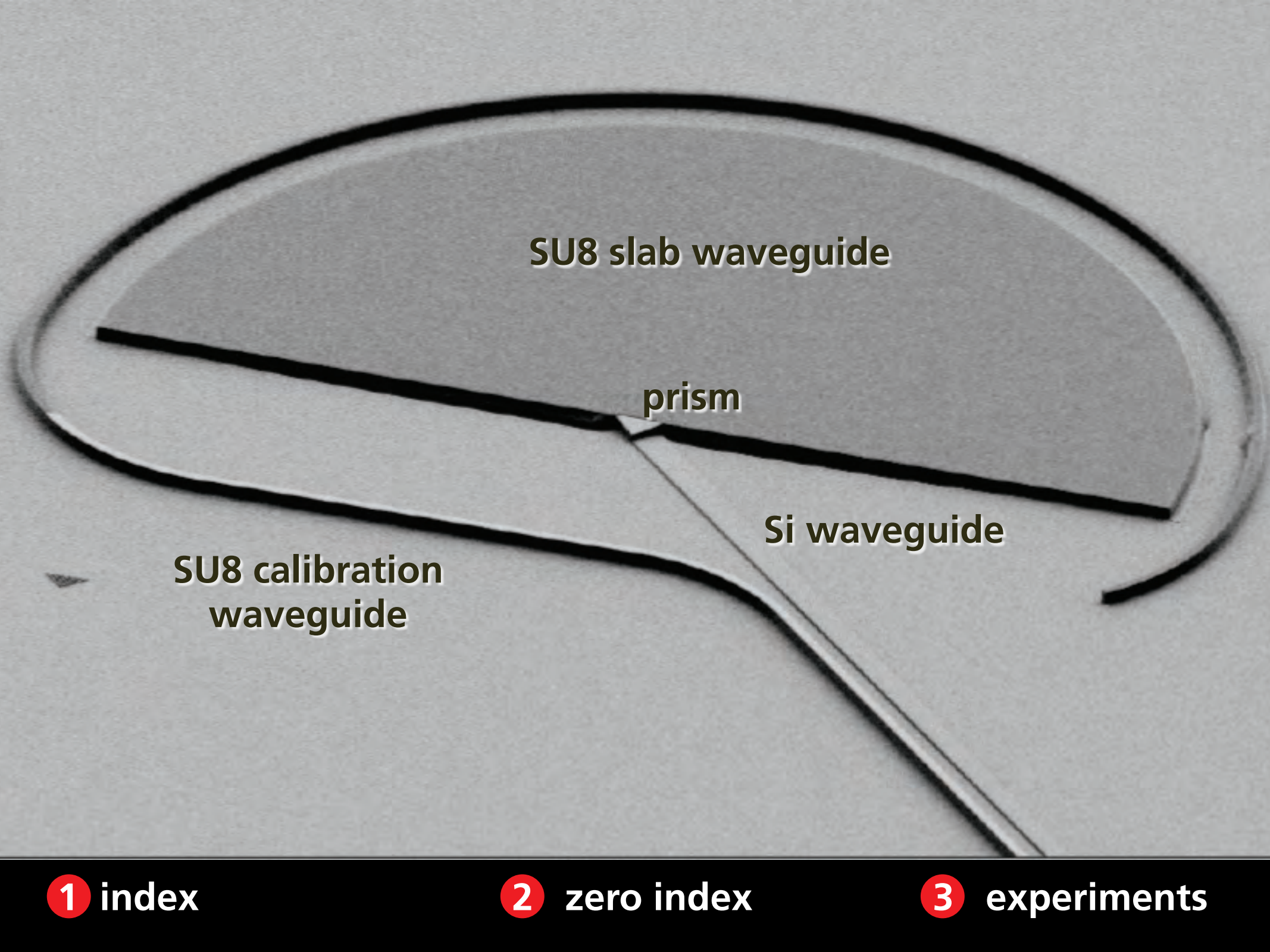

SU8 slab waveguide

prism

Si waveguide

SU8 calibration
waveguide

1 index

2 zero index

3 experiments

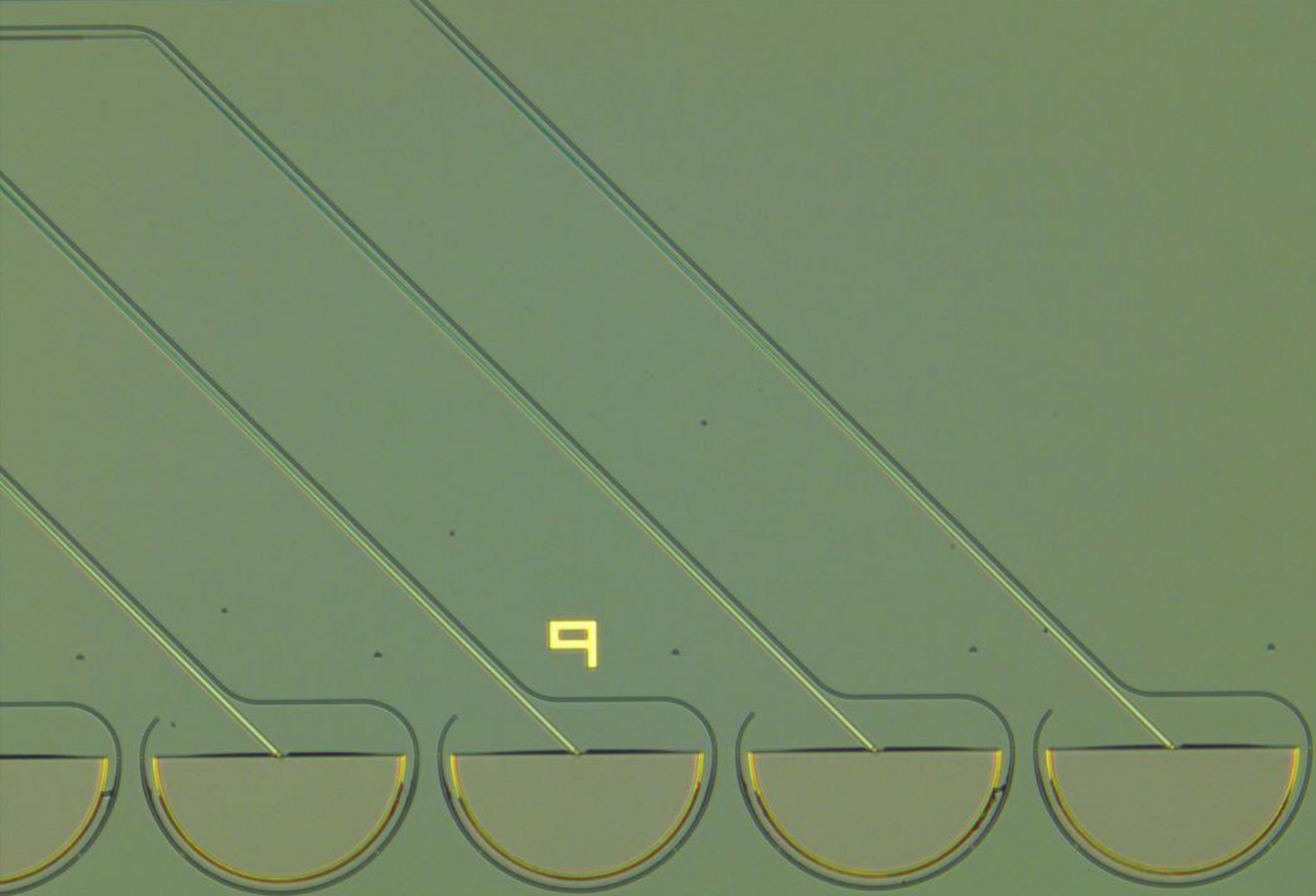

1 index

2 zero index

3 experiments

On-chip zero-index prism

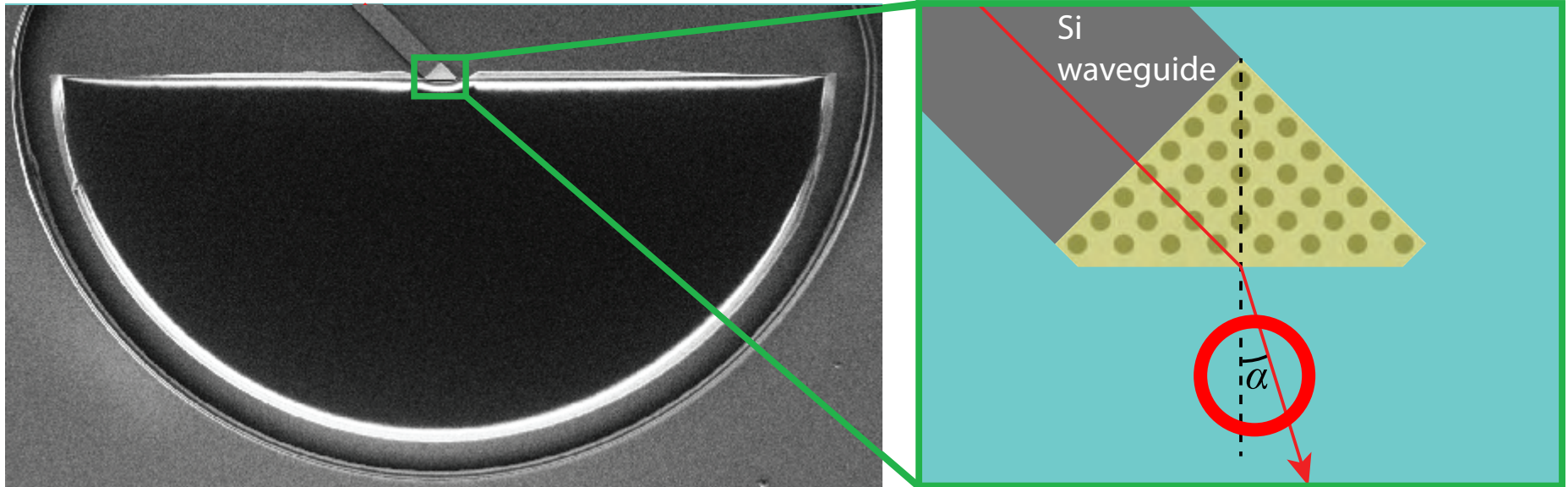

1 index

2 zero index

3 experiments

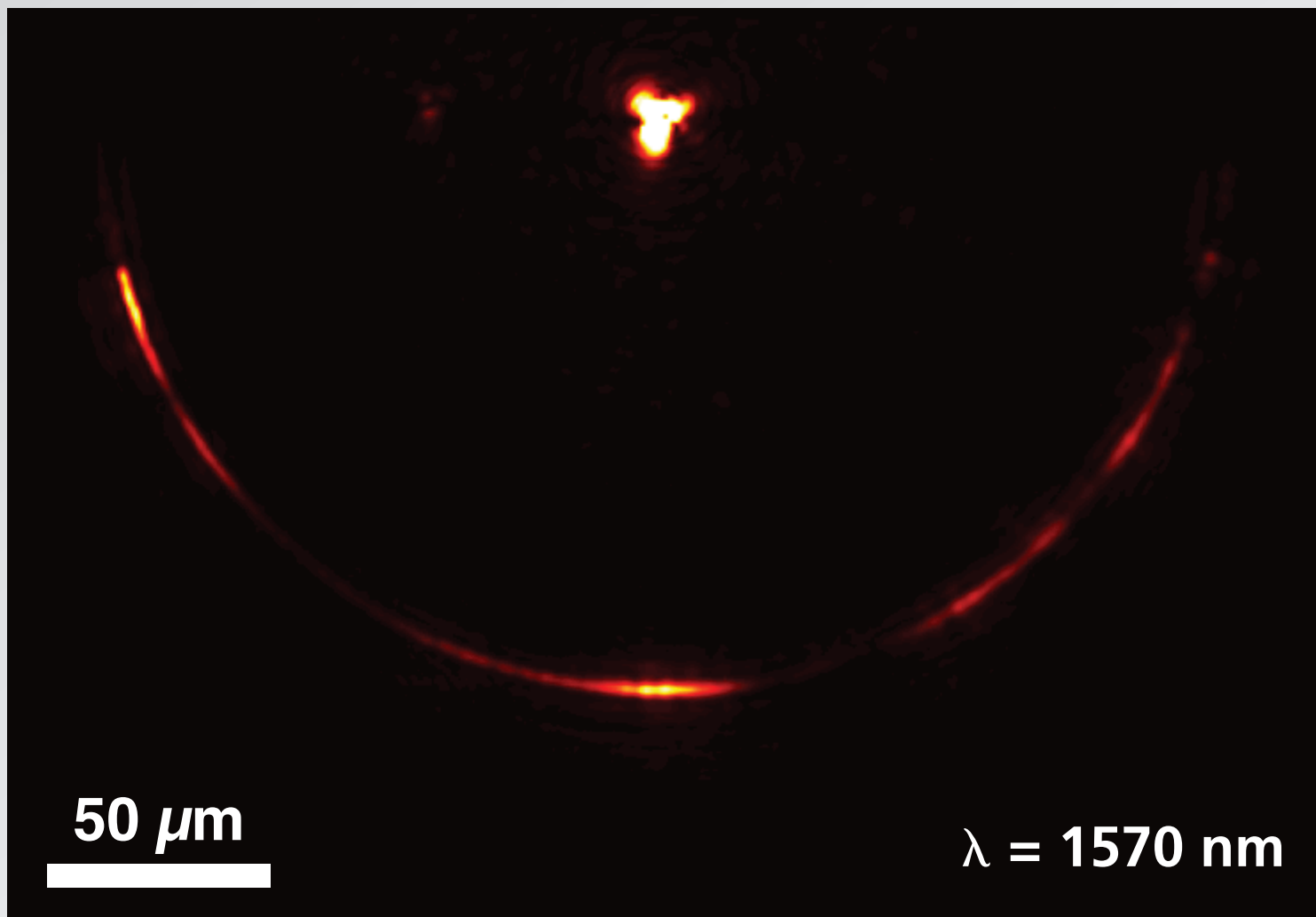

1 index

2 zero index

3 experiments

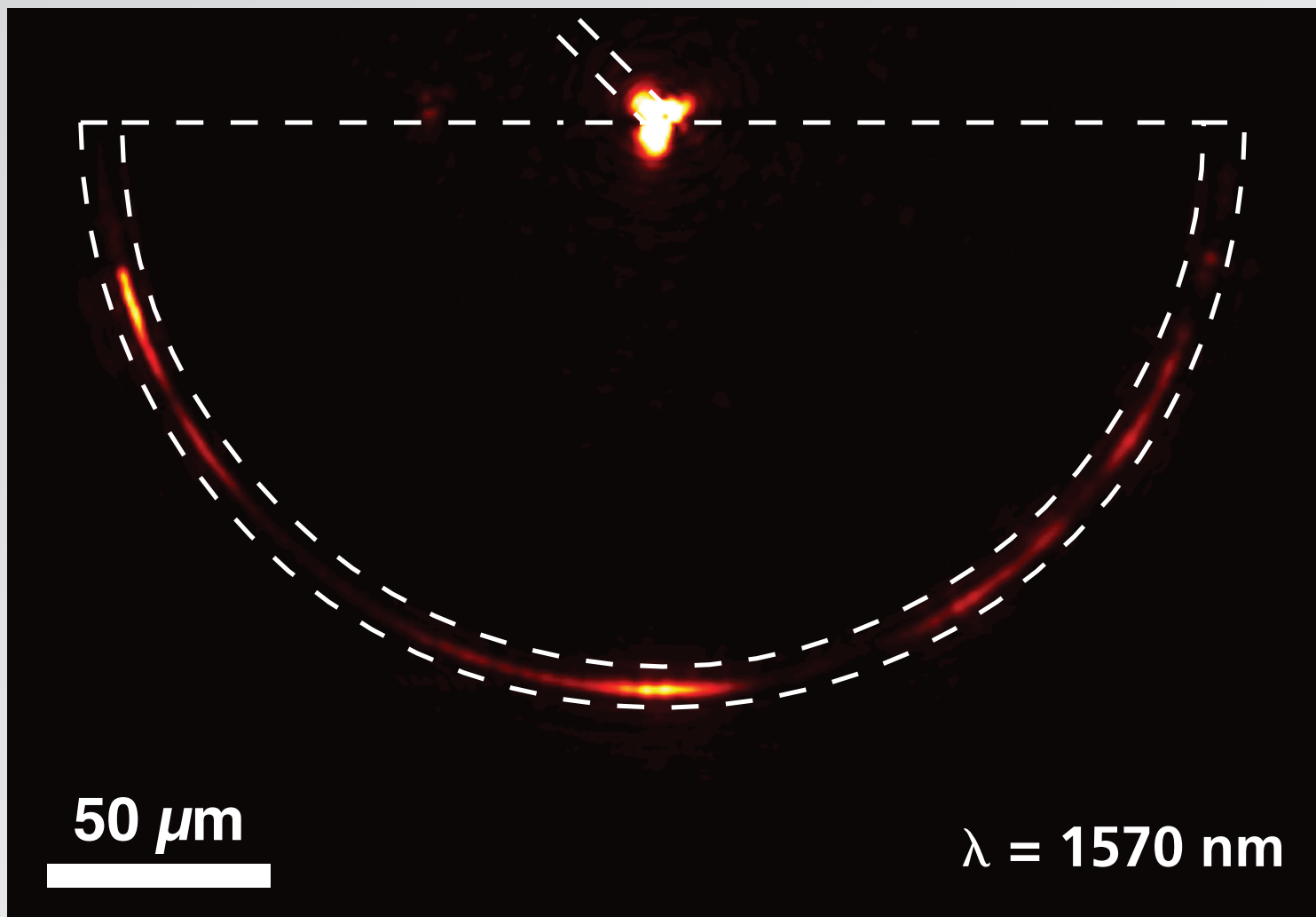

1 index

2 zero index

3 experiments

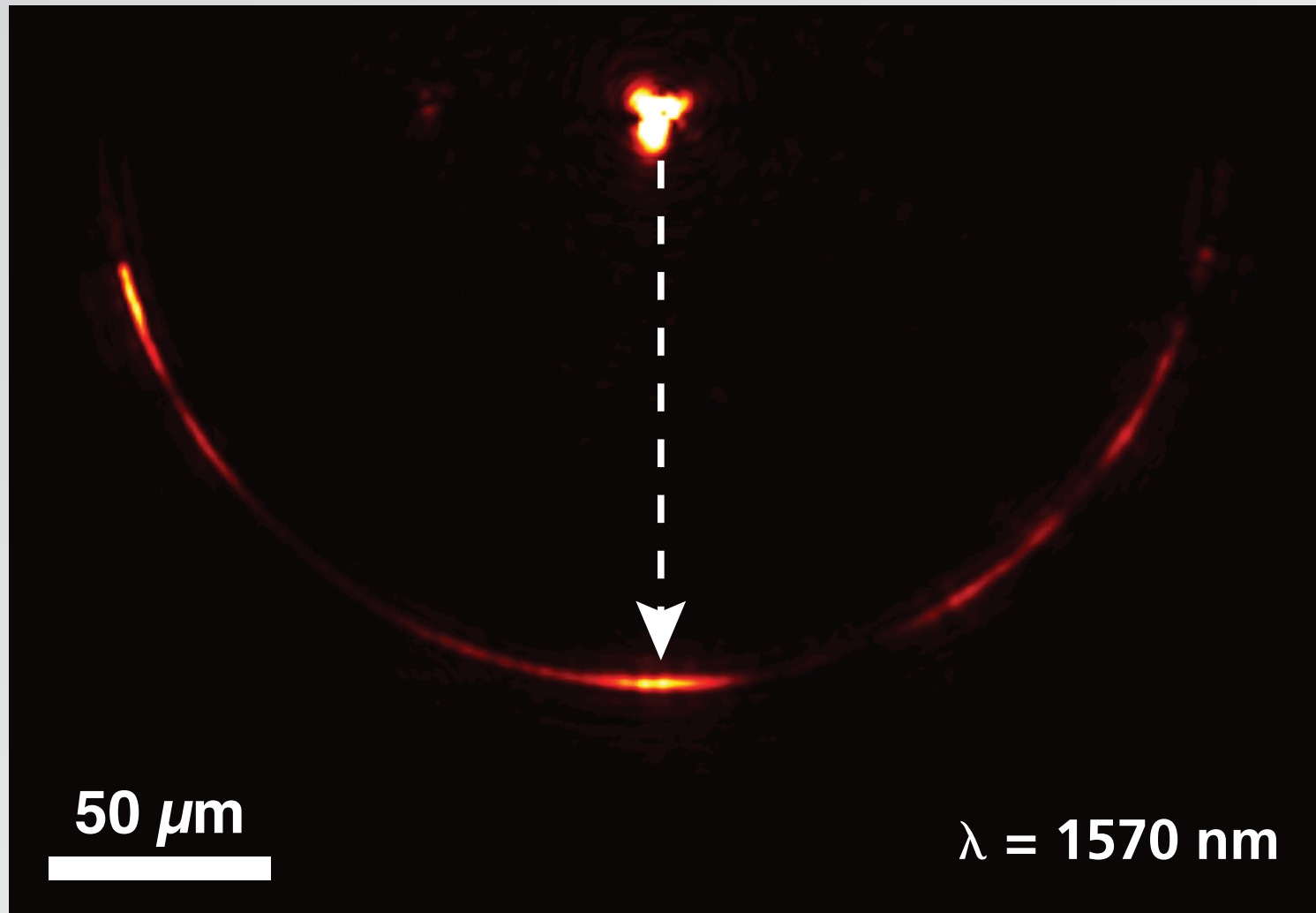

1 index

2 zero index

3 experiments

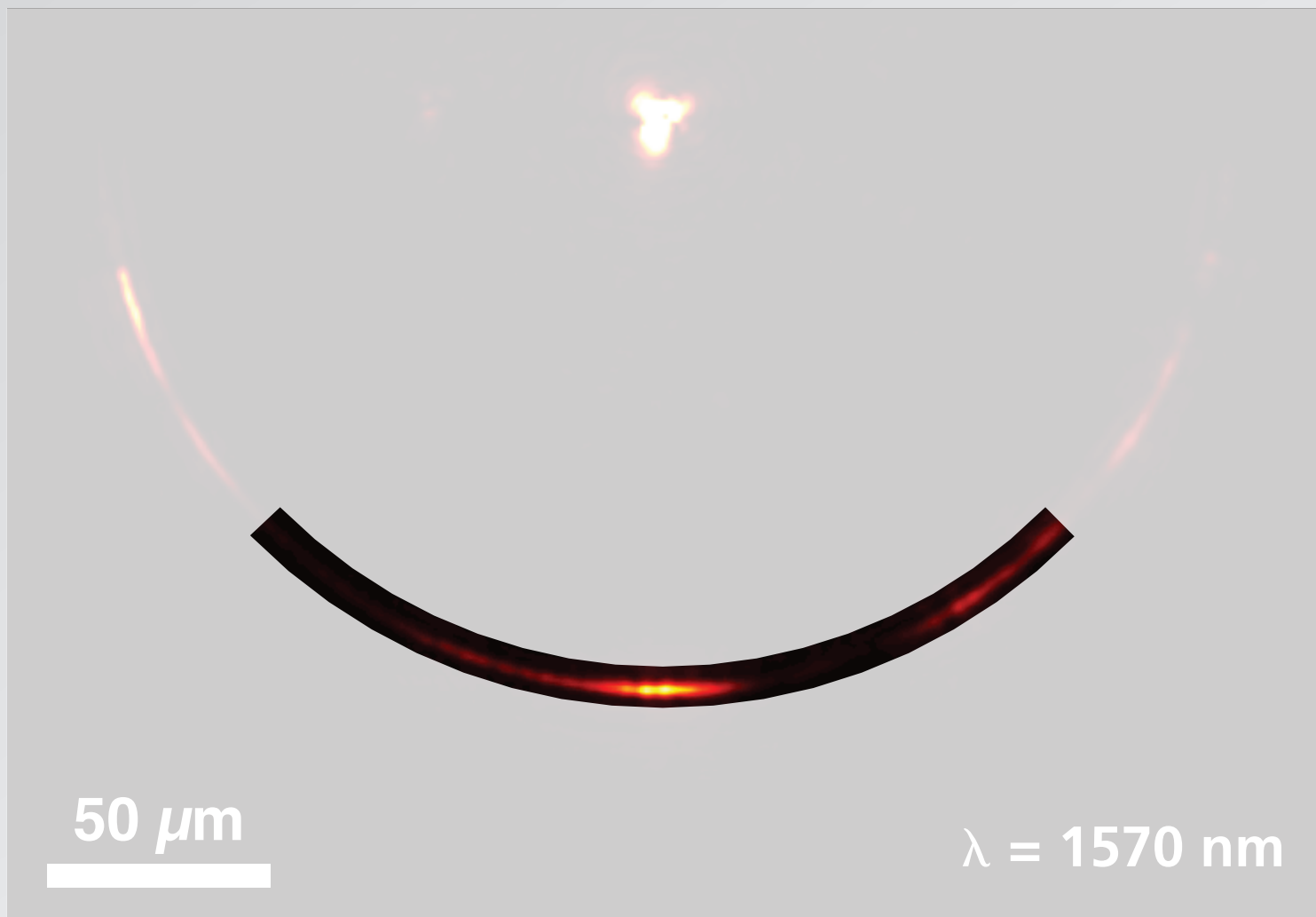

1 index

2 zero index

3 experiments

Wavelength dependence of refraction angle

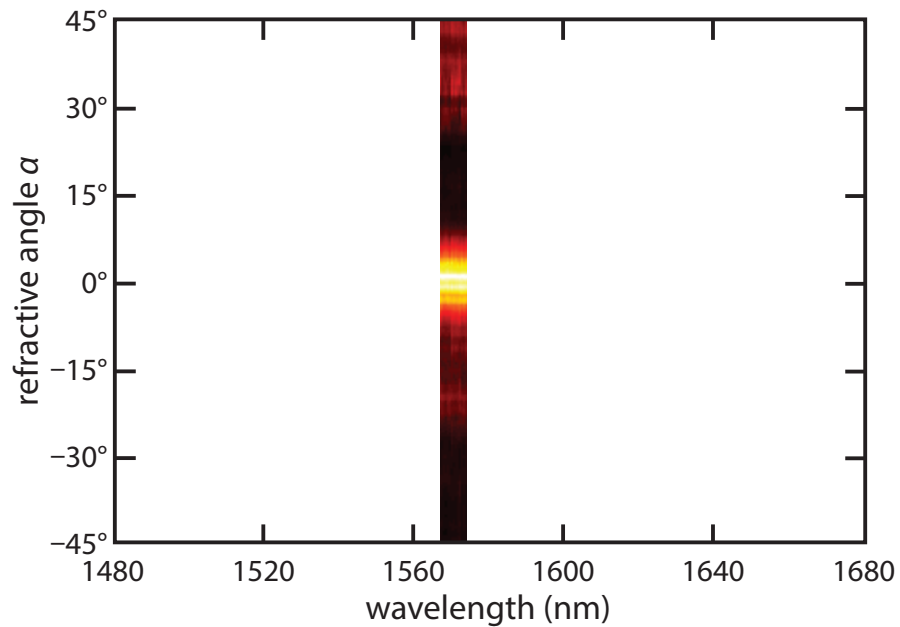

1 index

2 zero index

3 experiments

Wavelength dependence of refraction angle

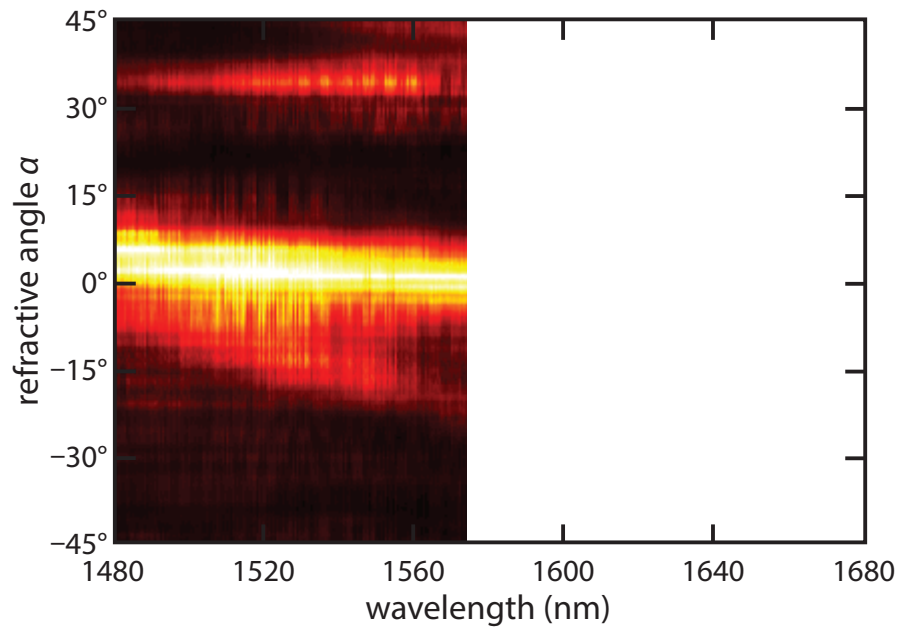

1 index

2 zero index

3 experiments

Wavelength dependence of refraction angle

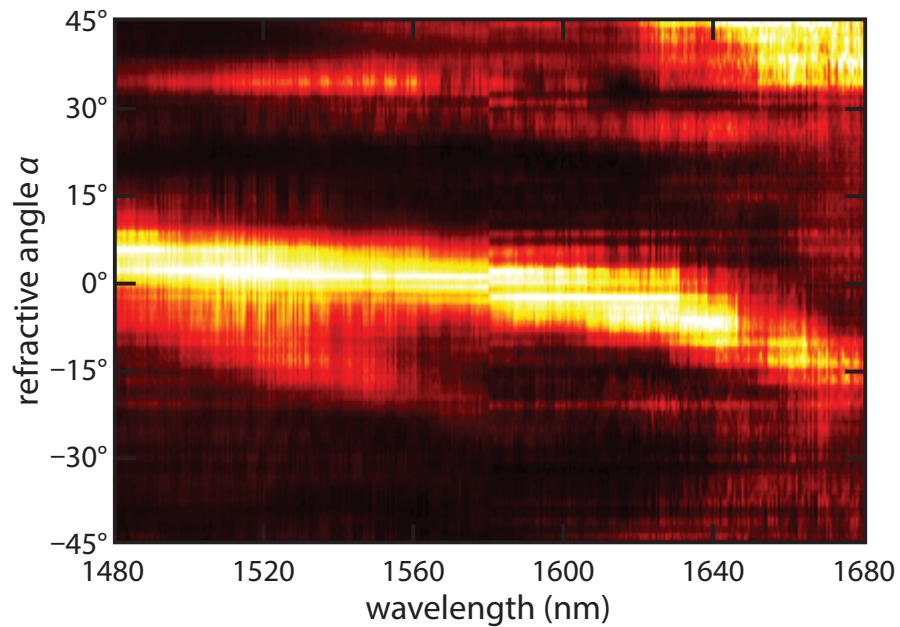

1 index

2 zero index

3 experiments

Wavelength dependence of refraction angle

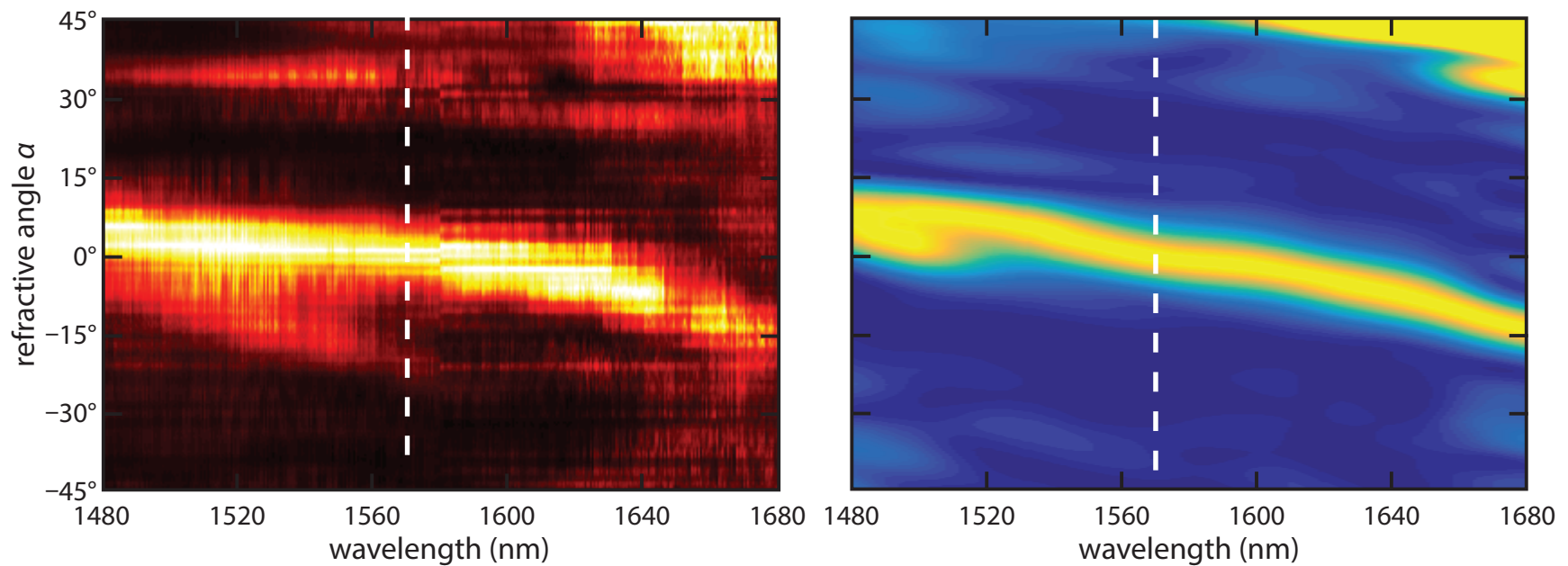

1 index

2 zero index

3 experiments

Wavelength dependence of index

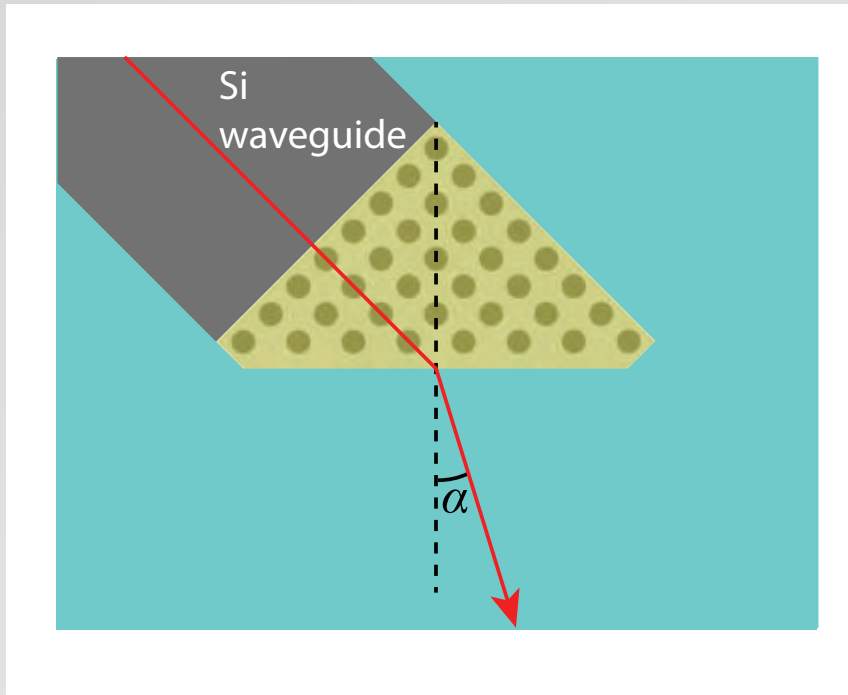

$$n_{\text{prism}} = n_{\text{slab}} \frac{\sin \alpha}{\sin 45^\circ}$$

1 index

2 zero index

3 experiments

Wavelength dependence of index

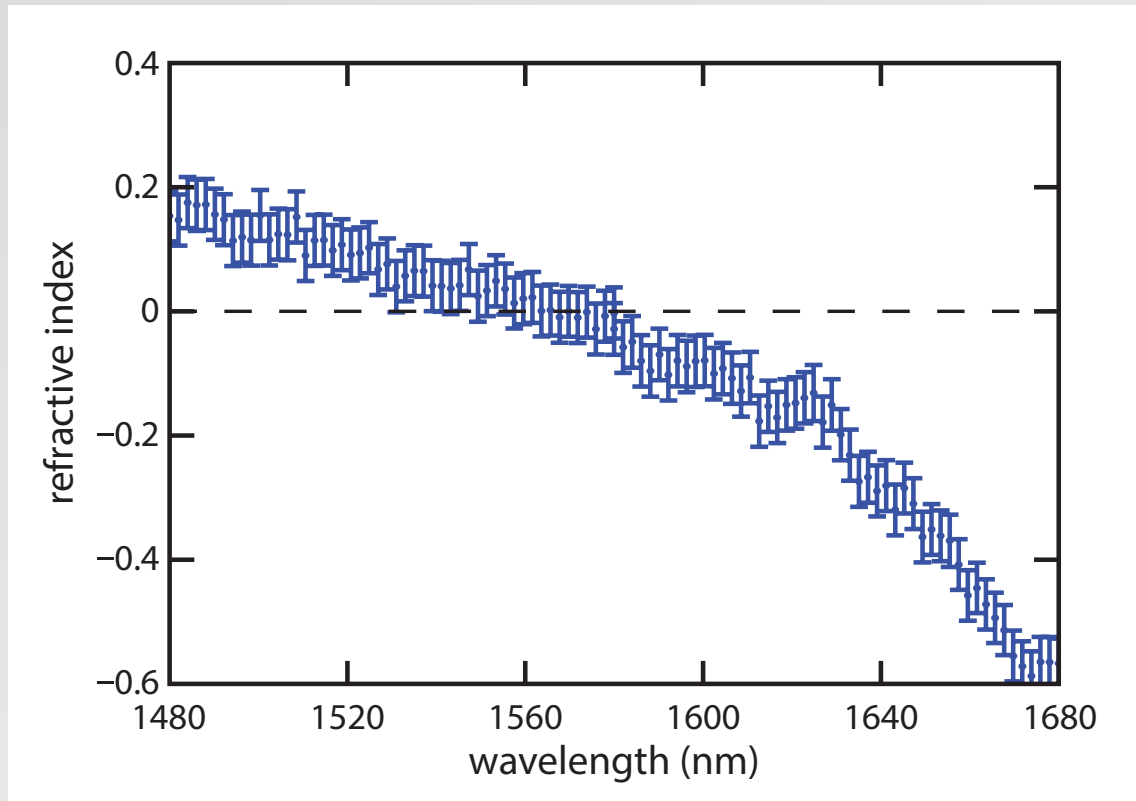

1 index

2 zero index

3 experiments

Wavelength dependence of index

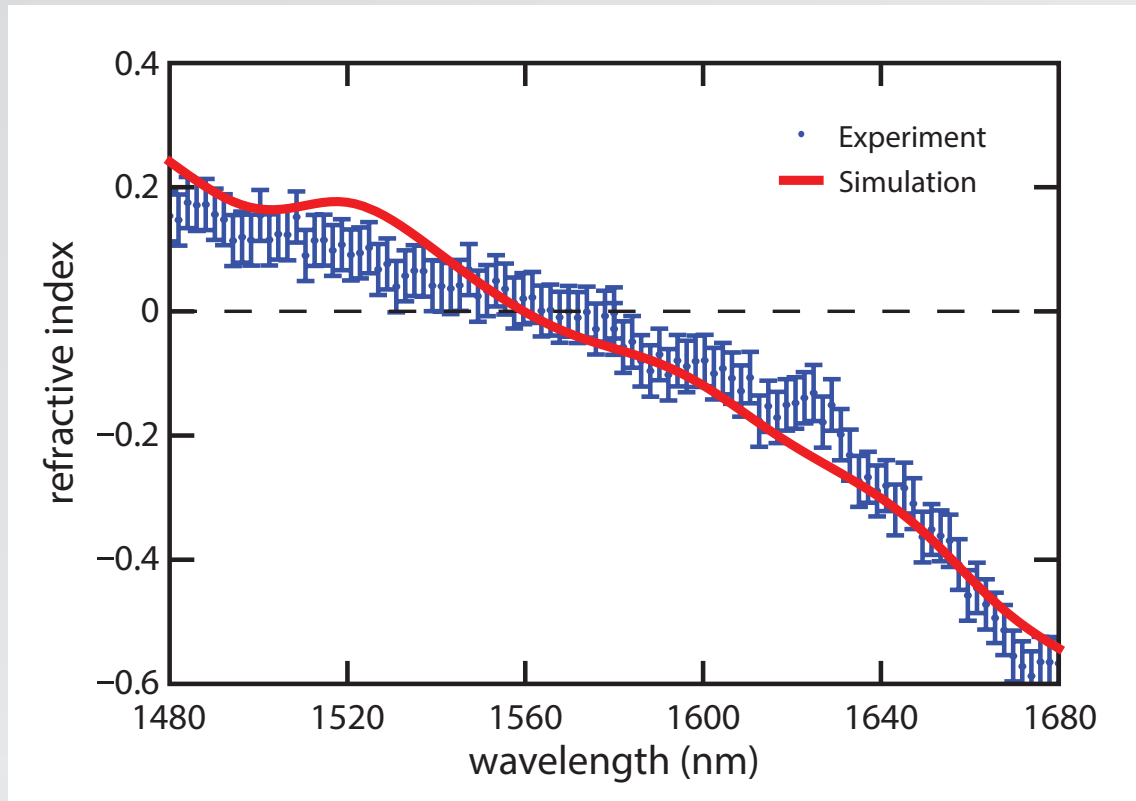

1 index

2 zero index

3 experiments

Wavelength dependence of index

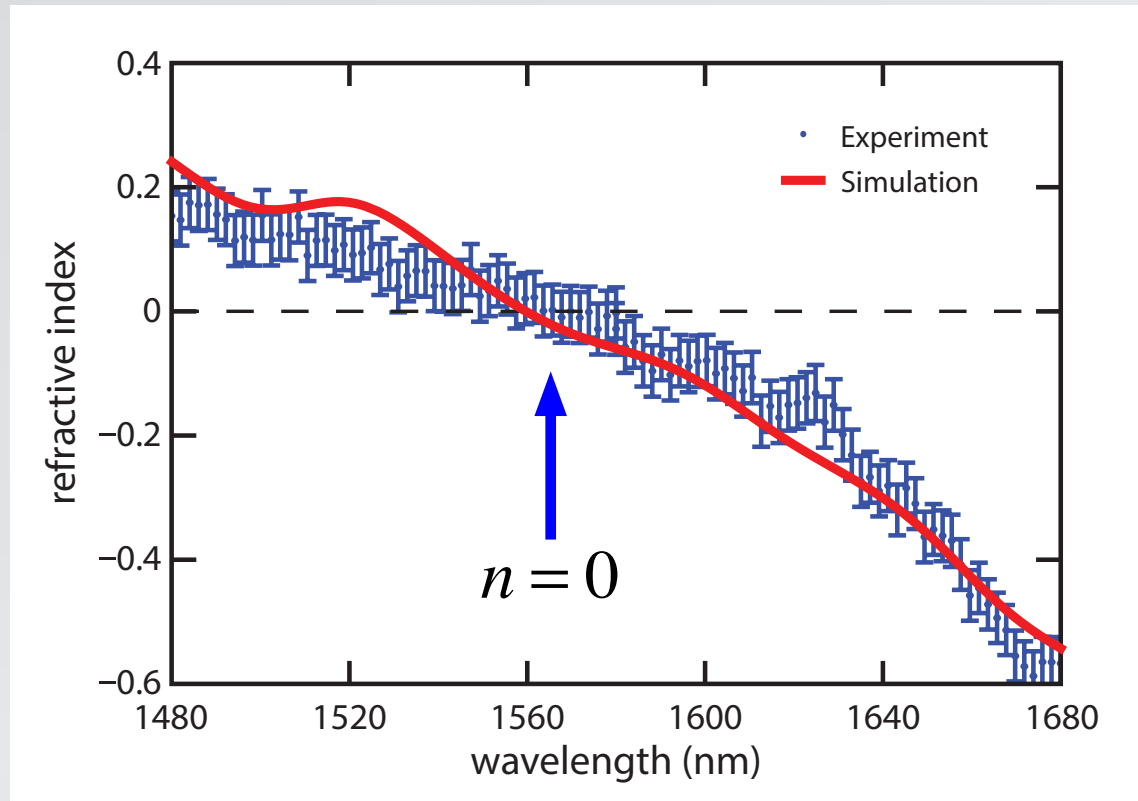

1 index

2 zero index

3 experiments

More info: download paper!

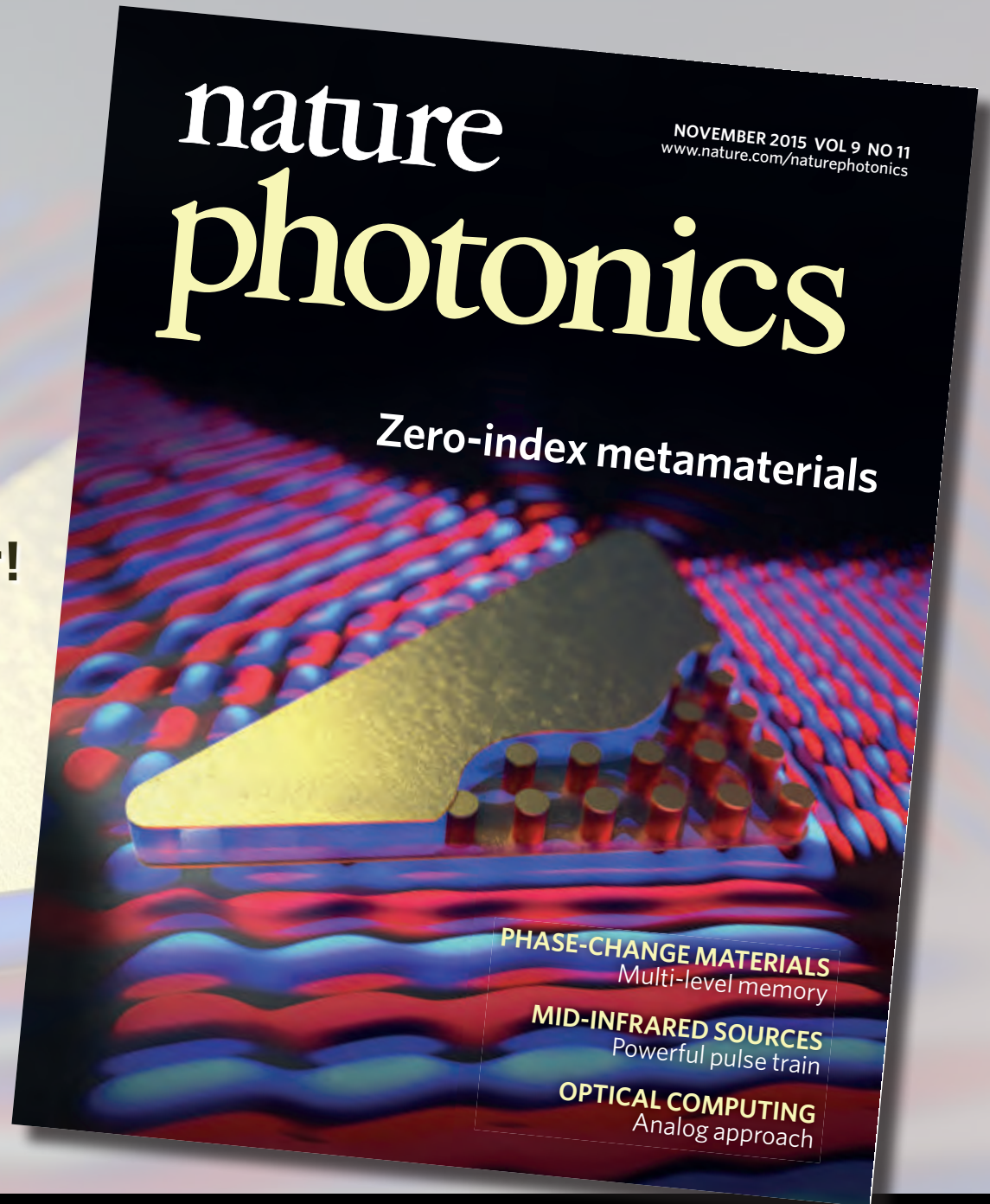

1 index

2 zero index

3 experiments

Where do we go from here?

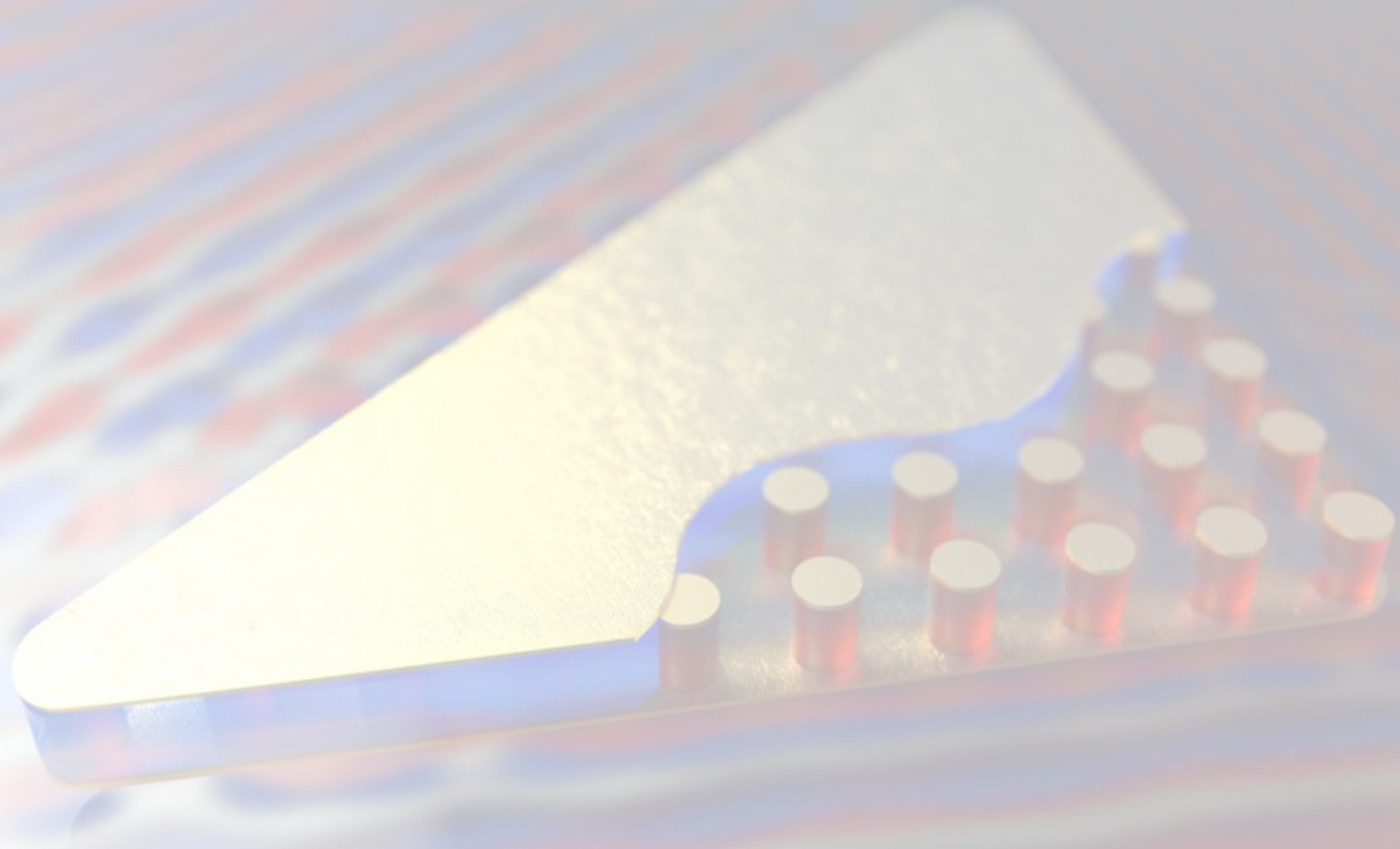

1 index

2 zero index

3 experiments

Where do we go from here?

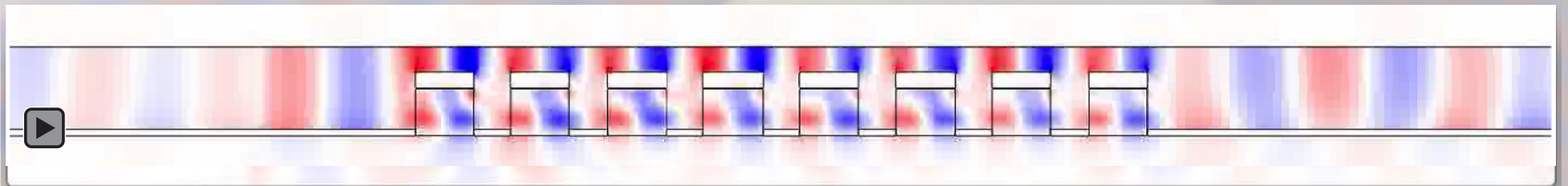

Need to eliminate losses in metal mirrors

1 index

2 zero index

3 experiments

Where do we go from here?

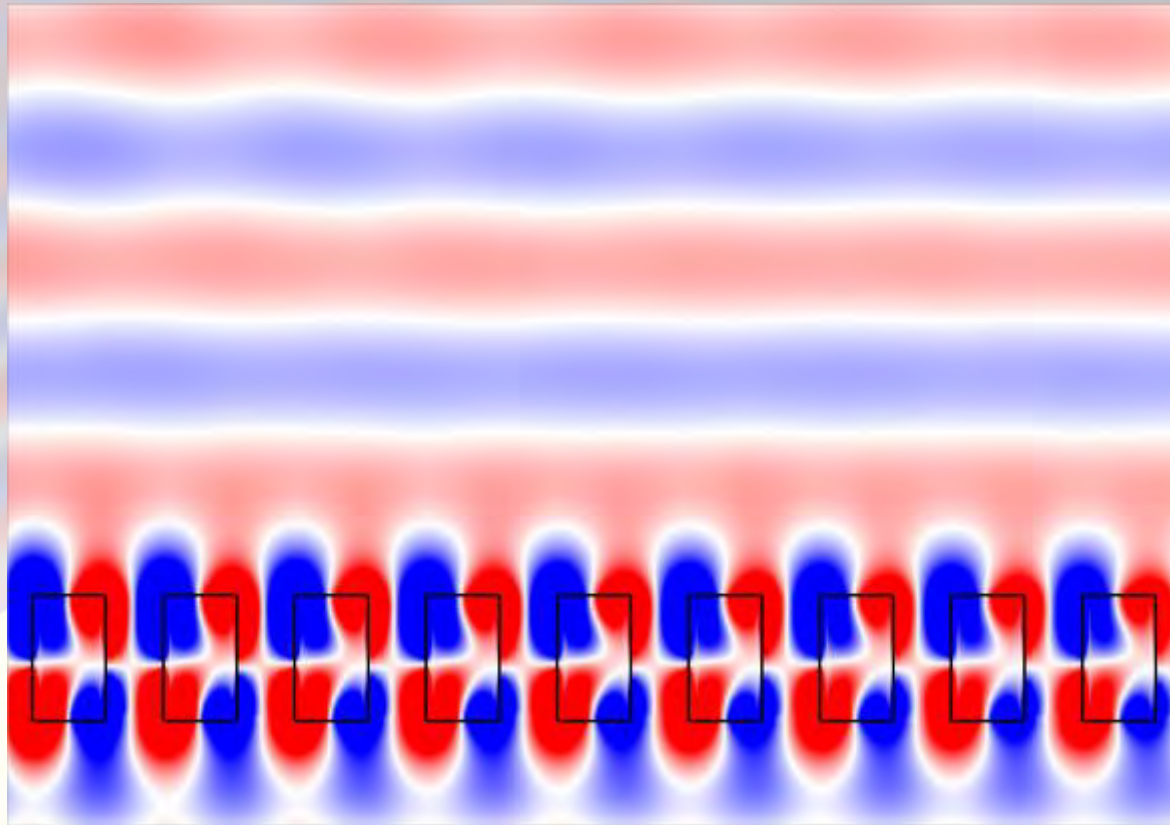

Removing mirrors causes radiative losses

1 index

2 zero index

3 experiments

Where do we go from here?

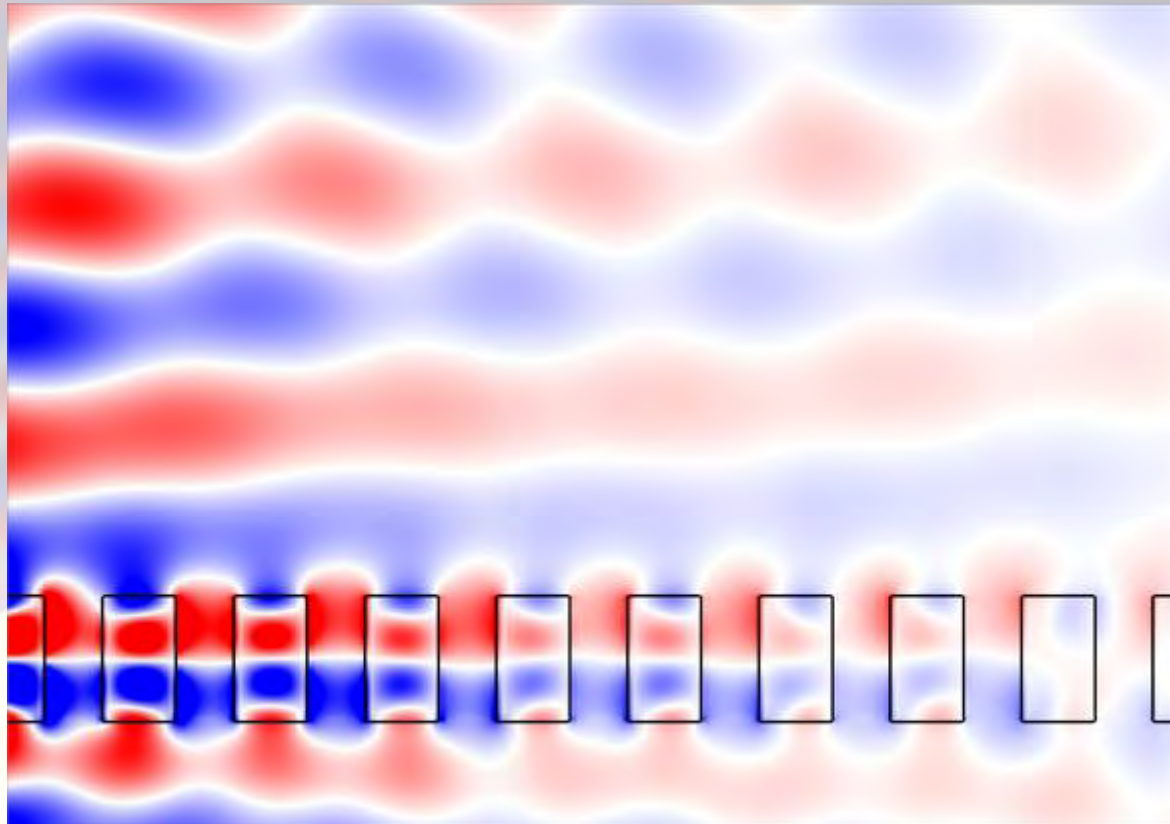

Radiative losses can be steered...

1 index

2 zero index

3 experiments

Where do we go from here?

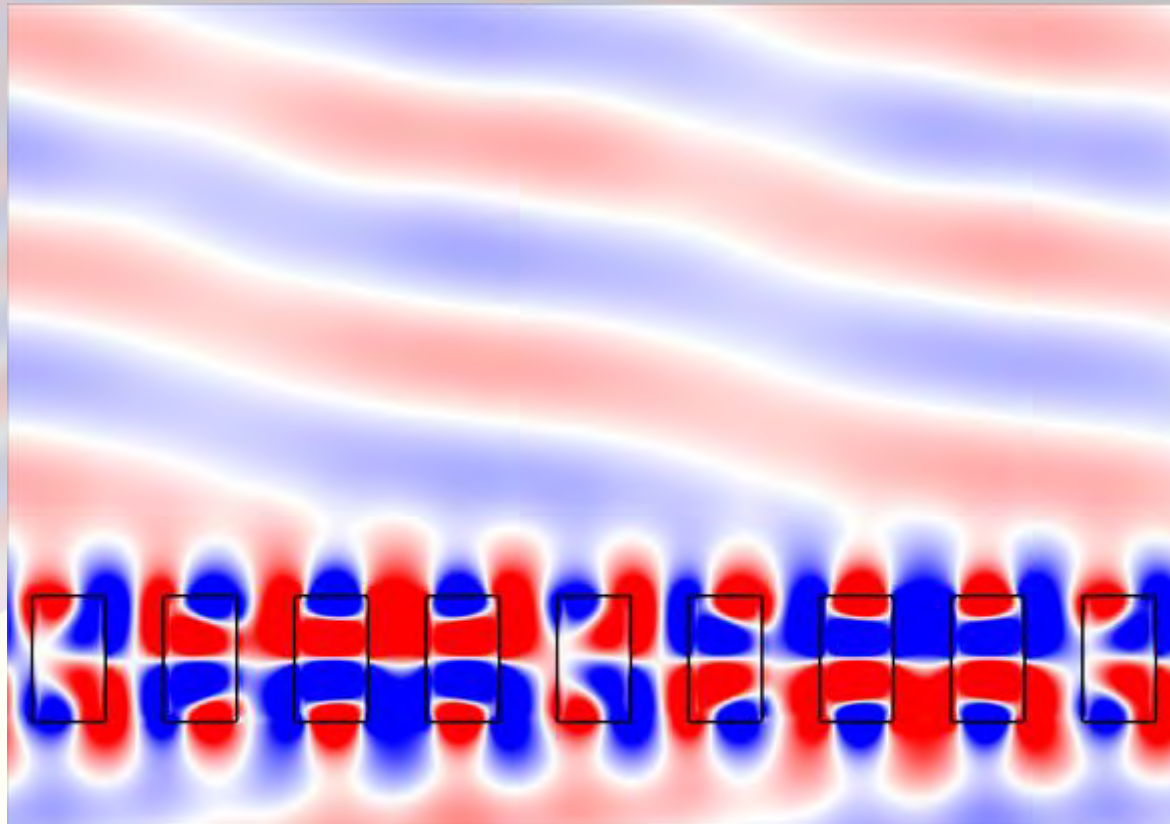

Radiative losses can be steered...

1 index

2 zero index

3 experiments

Where do we go from here?

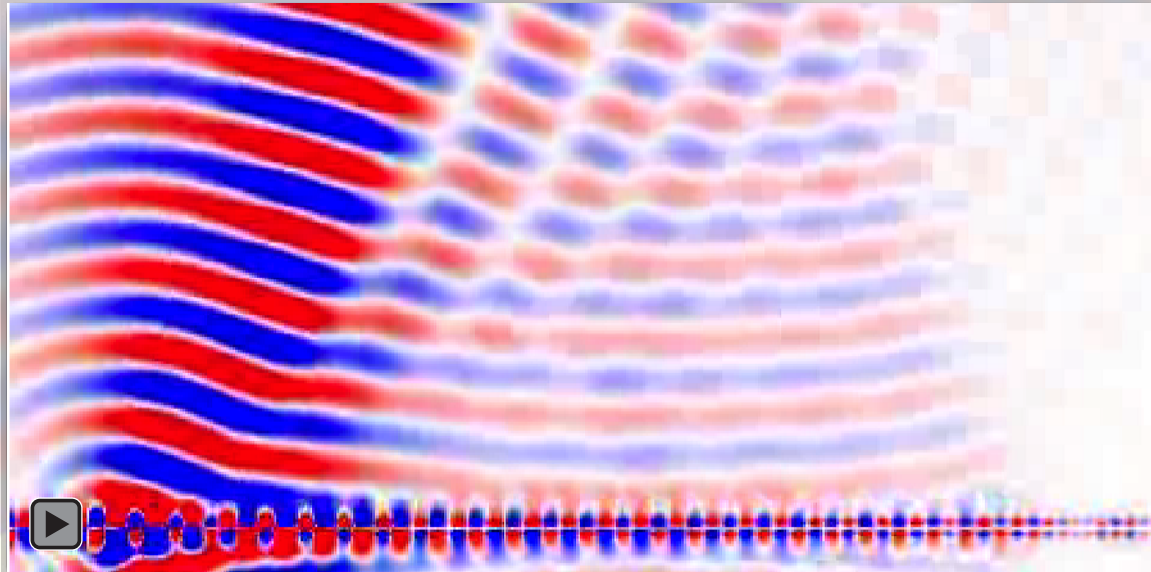

...or arranged to cause focusing...

1 index

2 zero index

3 experiments

Where do we go from here?

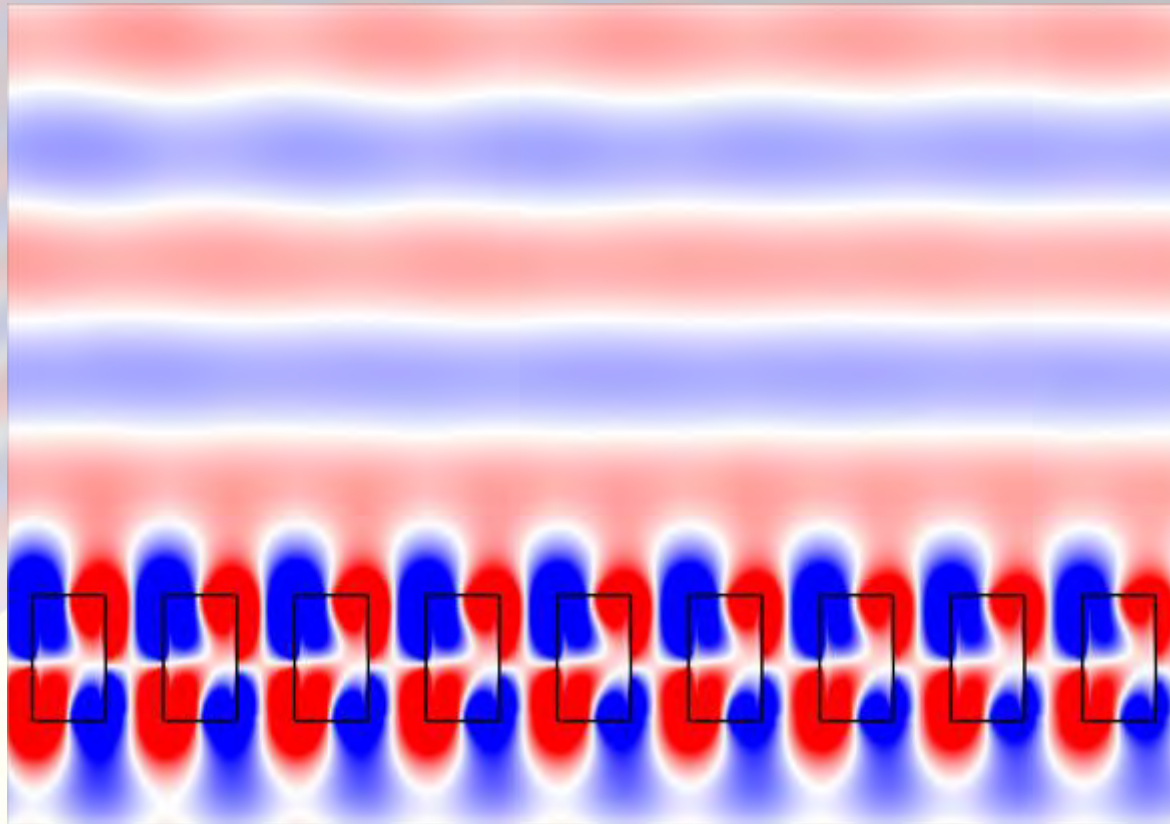

...or eliminated causing "bound in continuum" state

1 index

2 zero index

3 experiments

Where do we go from here?

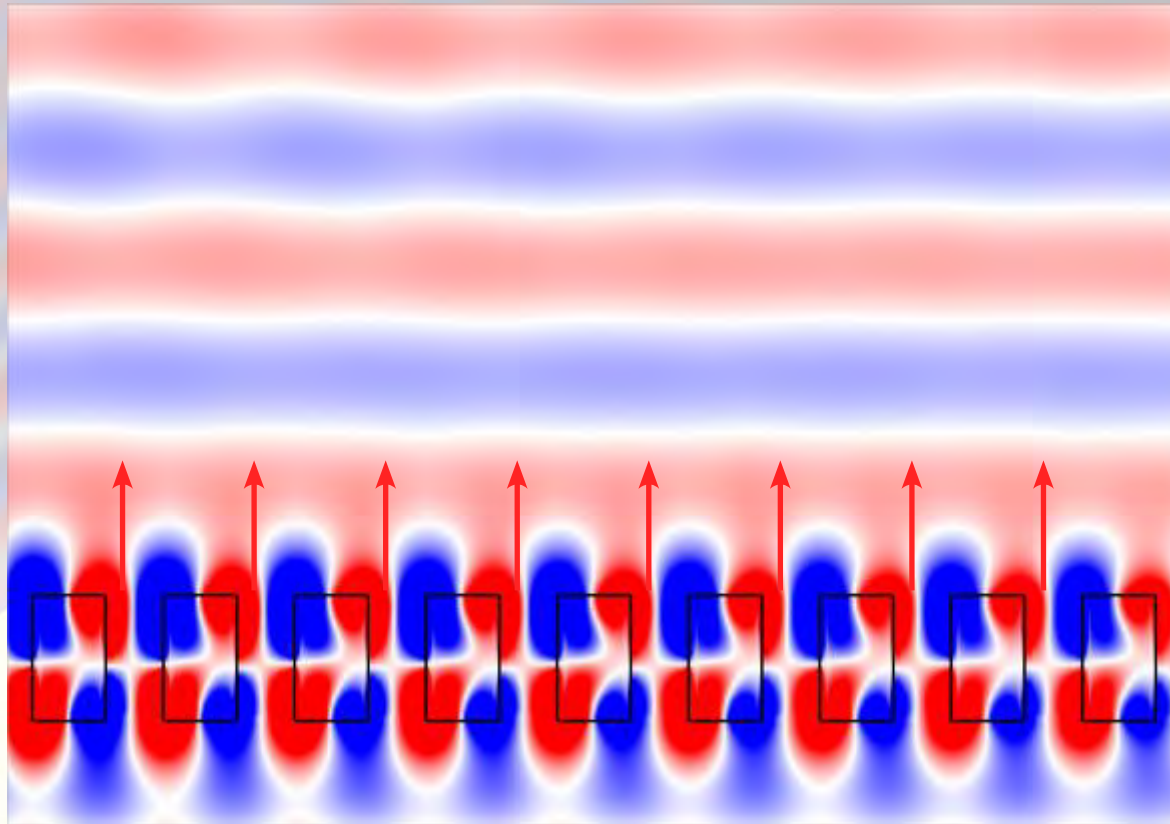

...or eliminated causing "bound in continuum" state

1 index

2 zero index

3 experiments

Where do we go from here?

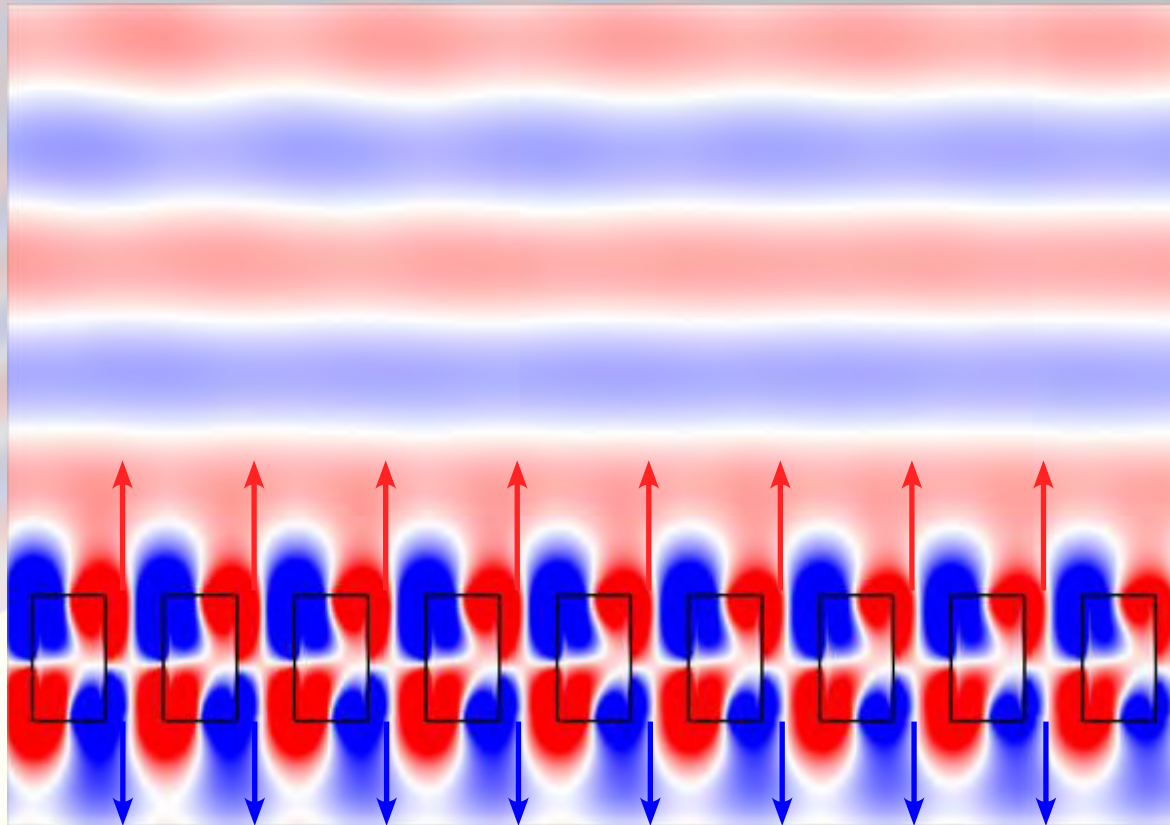

...or eliminated causing "bound in continuum" state

1 index

2 zero index

3 experiments

Where do we go from here?

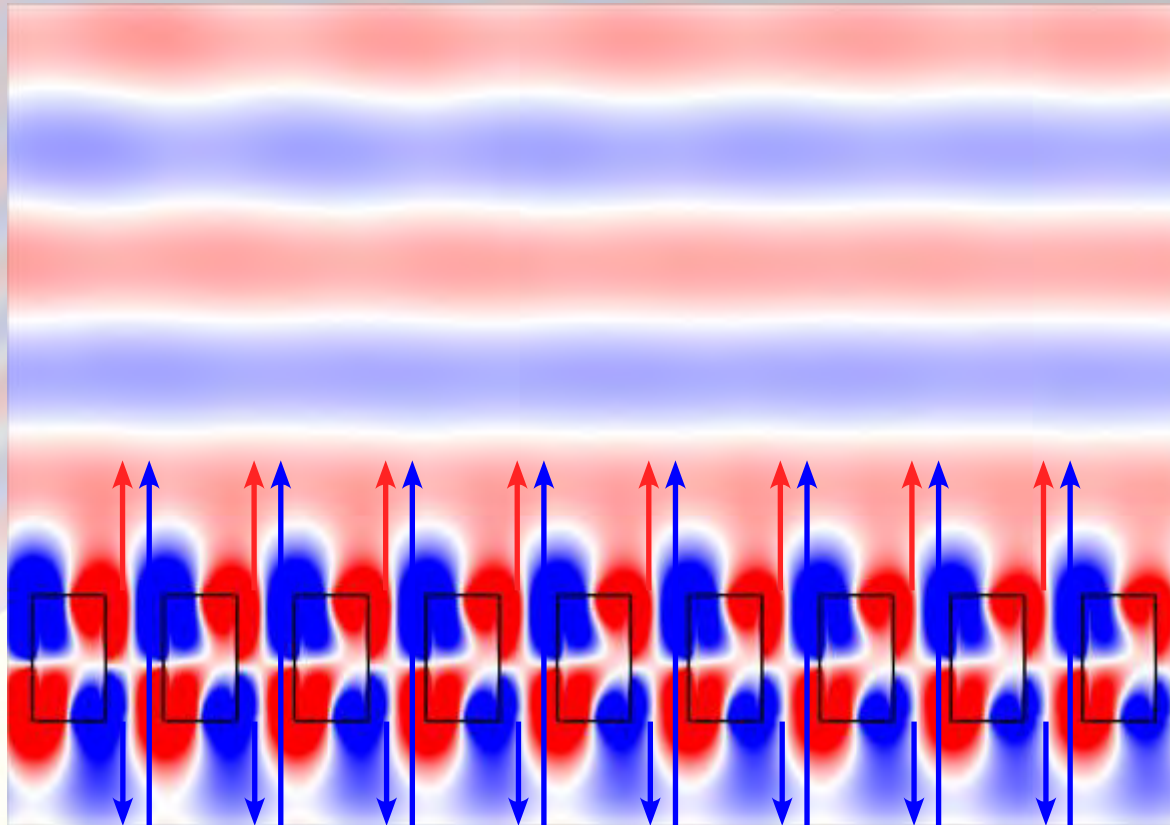

...or eliminated causing "bound in continuum" state

1 index

2 zero index

3 experiments

Where do we go from here?

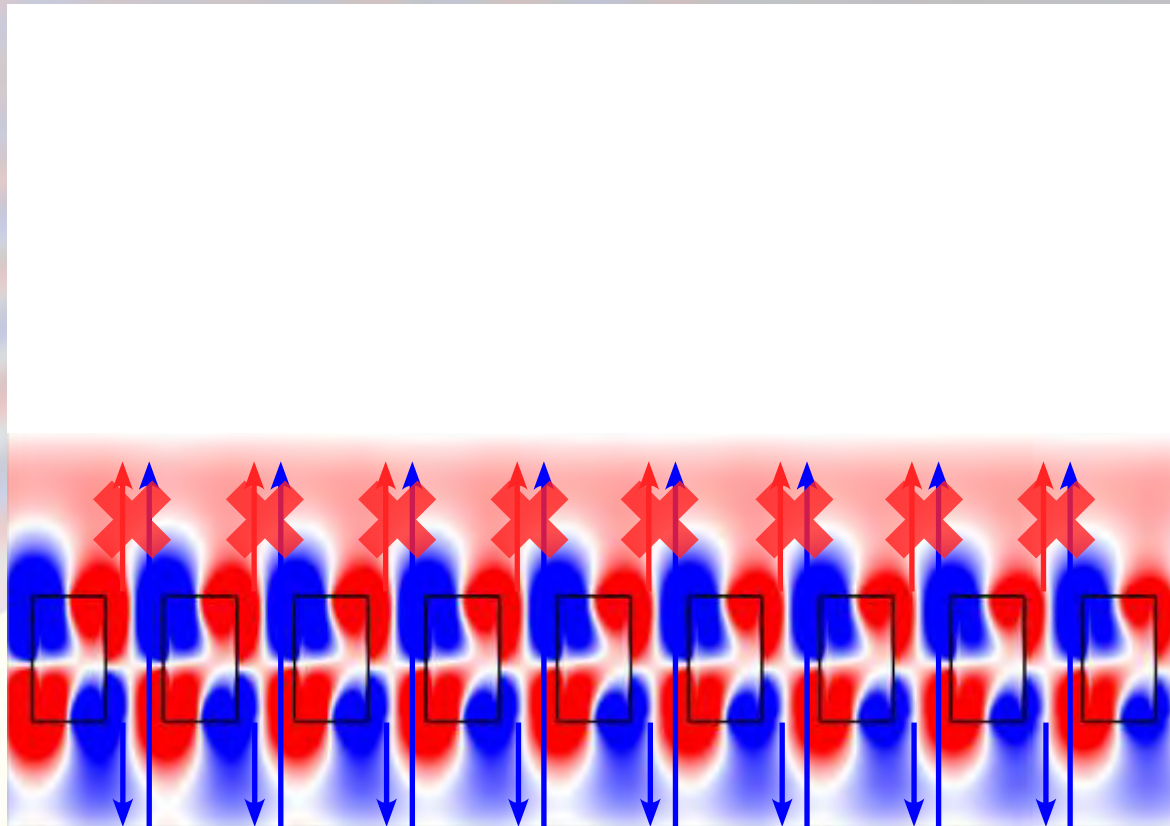

...or eliminated causing "bound in continuum" state

1 index

2 zero index

3 experiments

Where do we go from here?

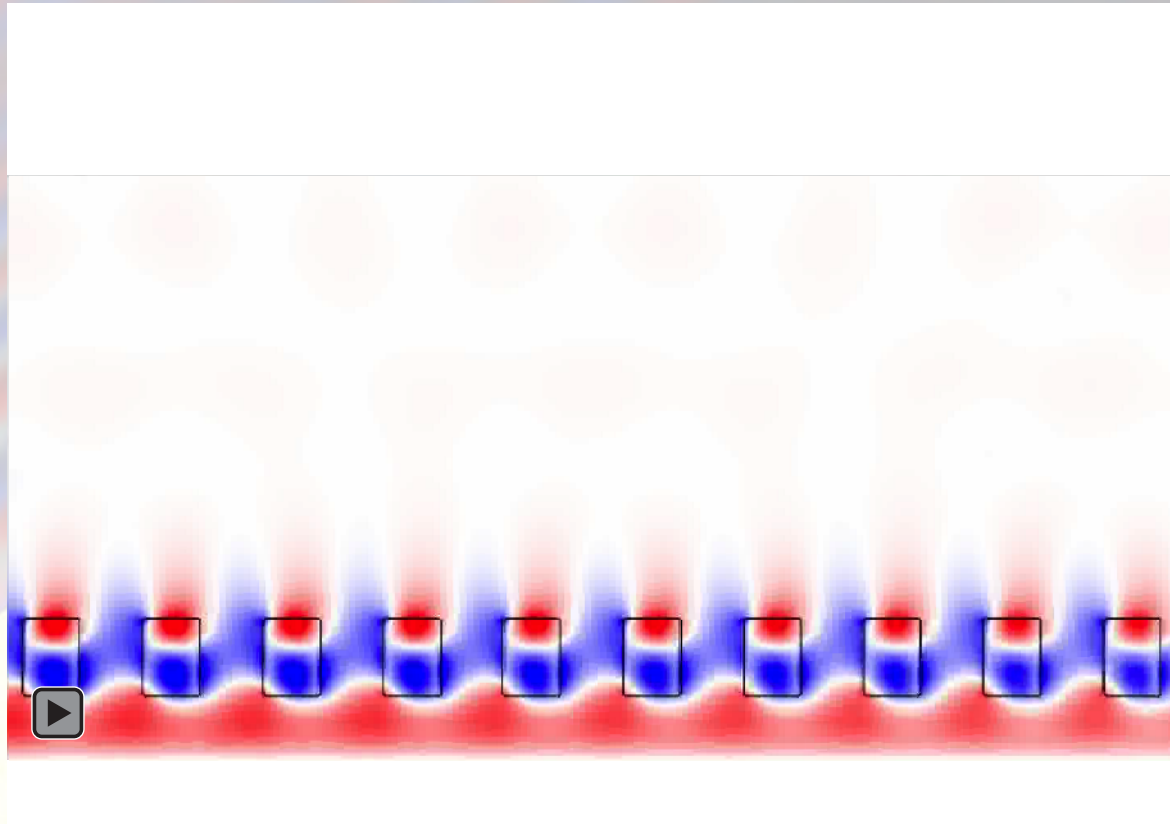

...or eliminated causing "bound in continuum" state

1 index

2 zero index

3 experiments

Exciting applications ahead

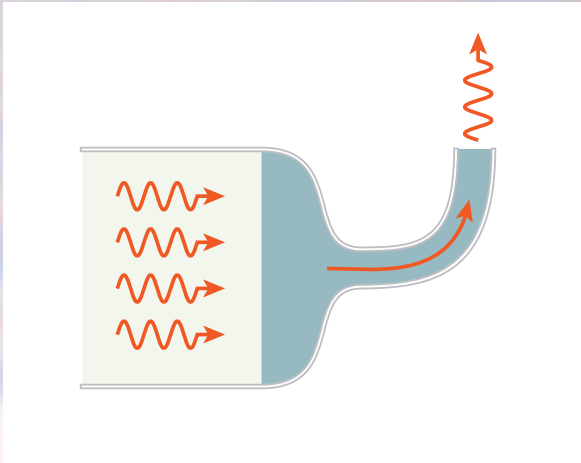

supercoupling

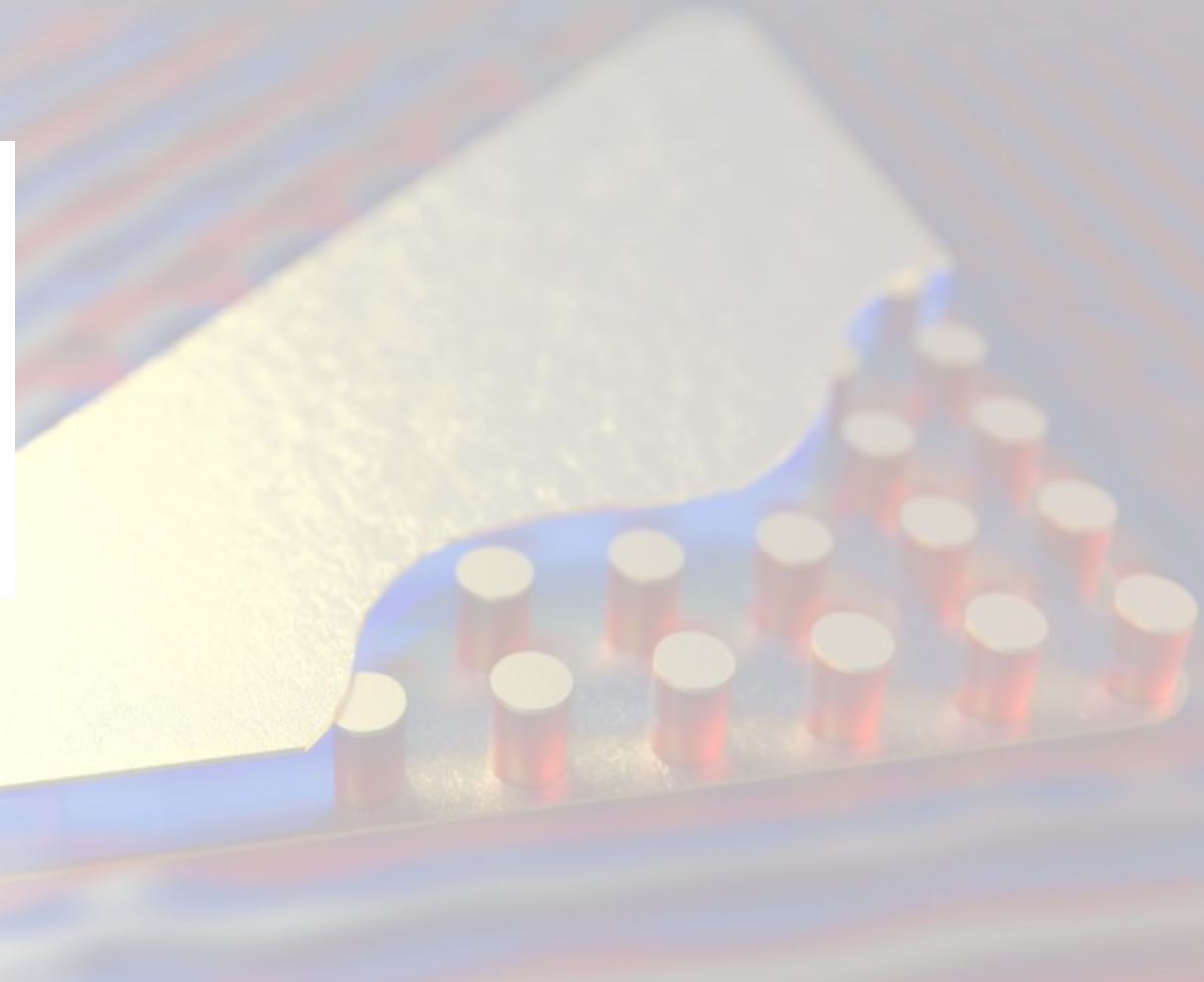

1 index

2 zero index

3 experiments

Exciting applications ahead

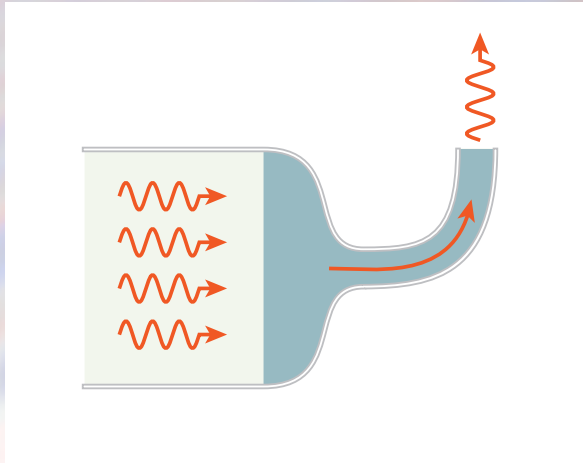

supercoupling



NLO

Exciting applications ahead

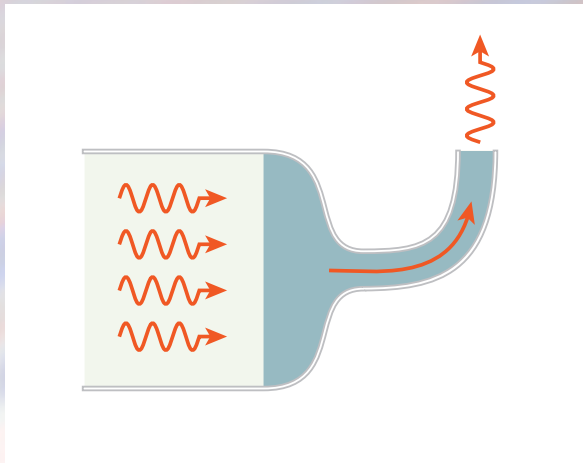

supercoupling

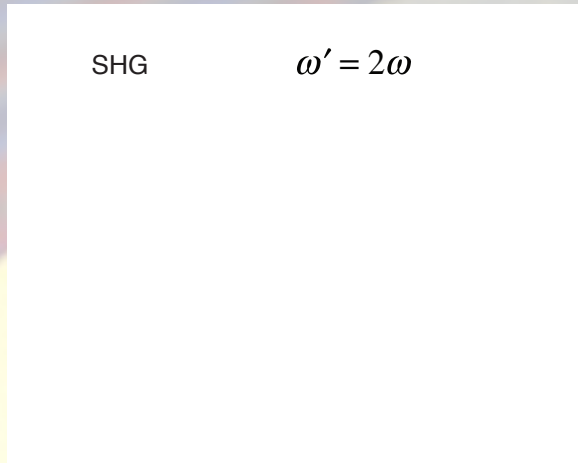

SHG

$$\omega' = 2\omega$$

NLO

1 index

2 zero index

3 experiments

Exciting applications ahead

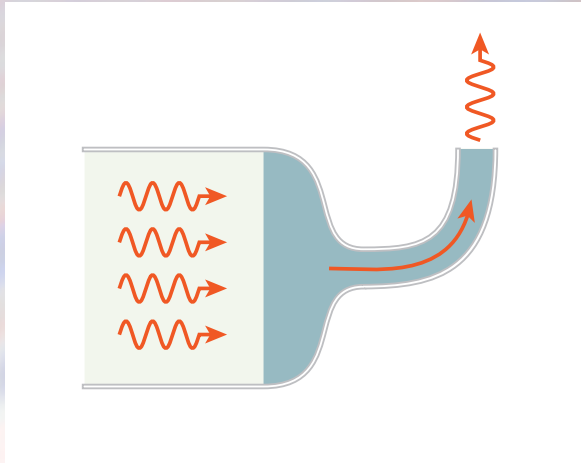

supercoupling

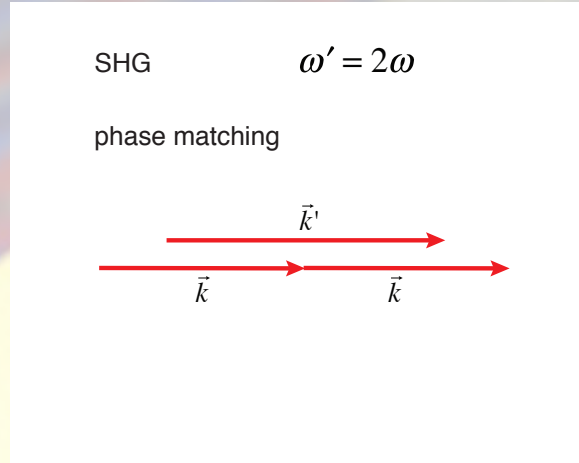

NLO

Exciting applications ahead

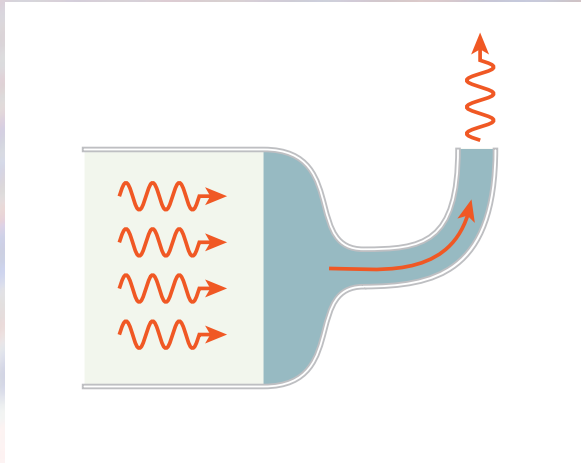

supercoupling

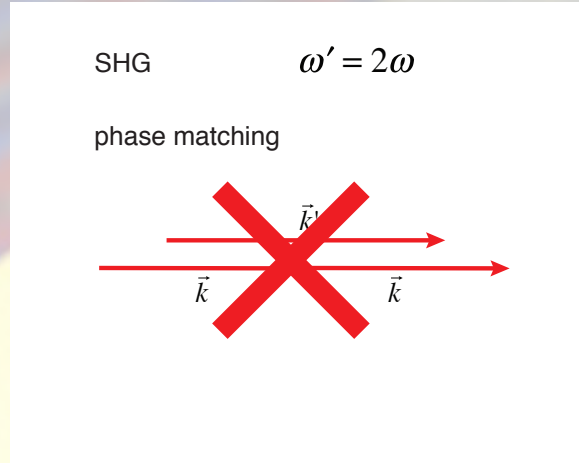

NLO

Exciting applications ahead

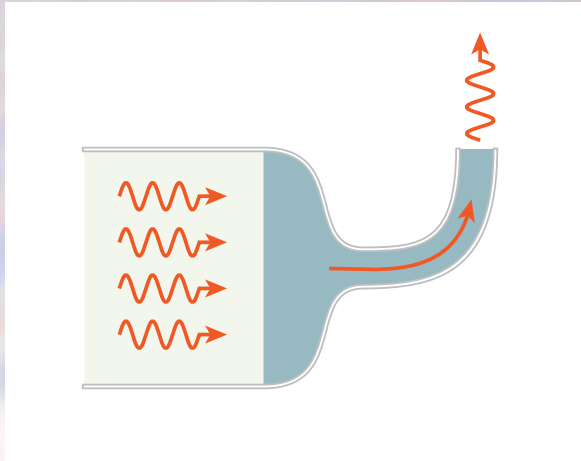

supercoupling

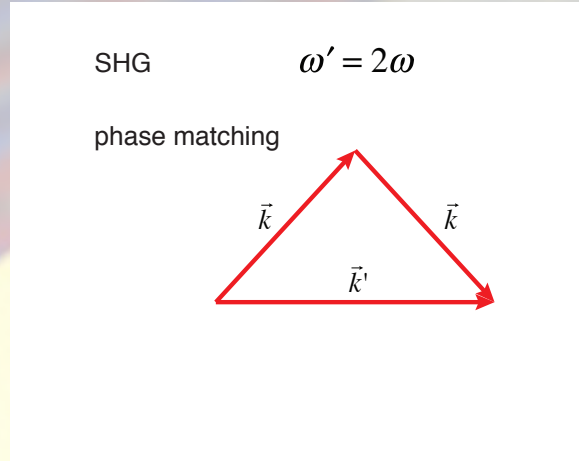

NLO

Exciting applications ahead

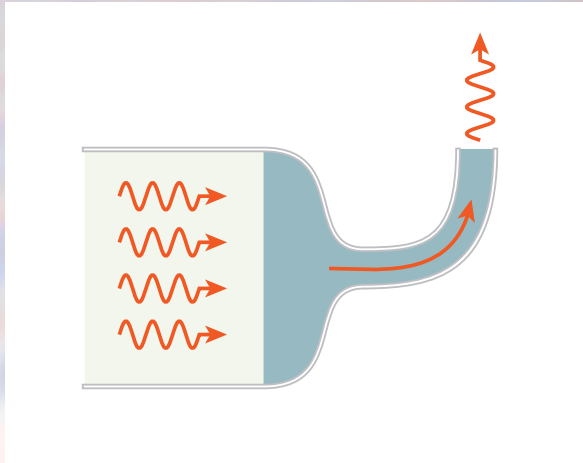

SHG

$$\omega' = 2\omega$$

at zero index

$$\vec{k} = 0$$

supercoupling

NLO

1 index

2 zero index

3 experiments

Exciting applications ahead

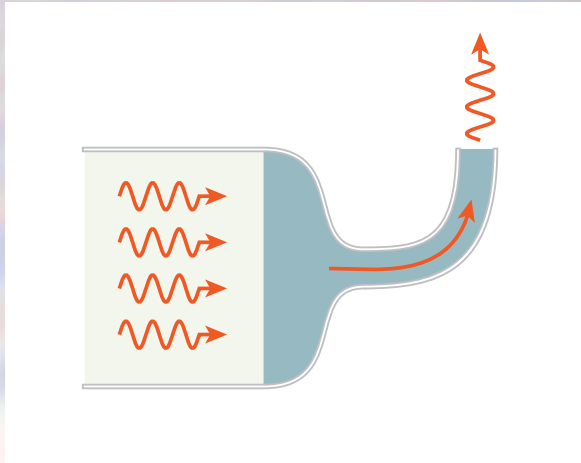

supercoupling

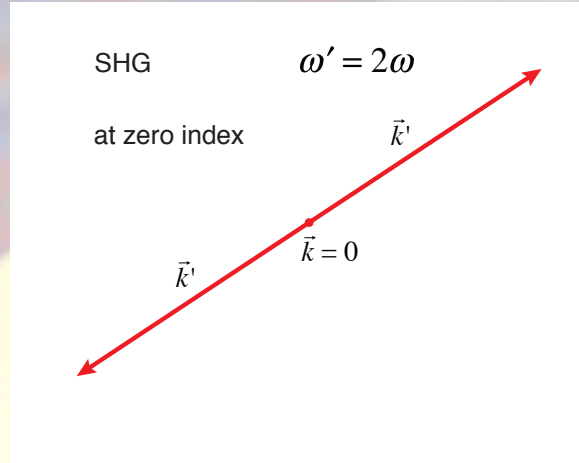

NLO

Exciting applications ahead

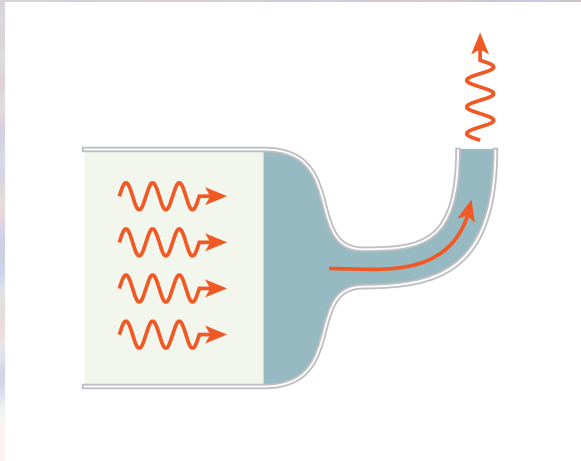

supercoupling

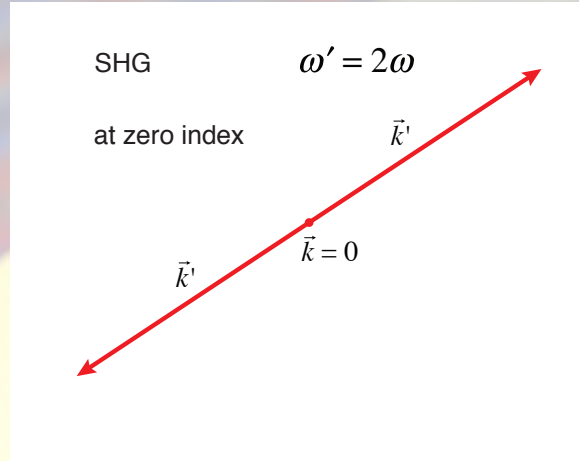

NLO

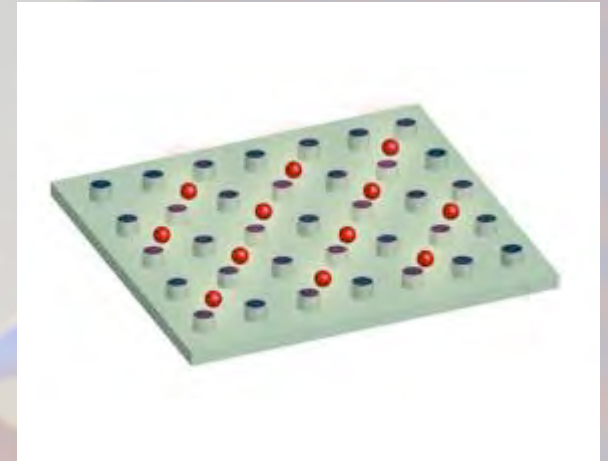

quantum optics

**Yang Li, Shota Kita, Phil Muñoz, Orad Reshef,
Daryl Vulis, Mei Yin, Lysander Christakis, Zin Lin,
Cleaven Chia, Olivia Mello, Haoning Tang, Marko Lončar**

**National Science Foundation
Harvard Center for Nanoscale Systems**

for a copy of this presentation:

<http://ericmazur.com>

Follow me!



eric_mazur