

INTRODUCTORY SCIENCE LECTURES: A MISSED OPPORTUNITY

**Eric Mazur
Harvard University**

**Hechinger Institute on Education and the Media
New York, NY
25 September 1999**



We have a problem

**380,000 students take
introductory physics
each year...**

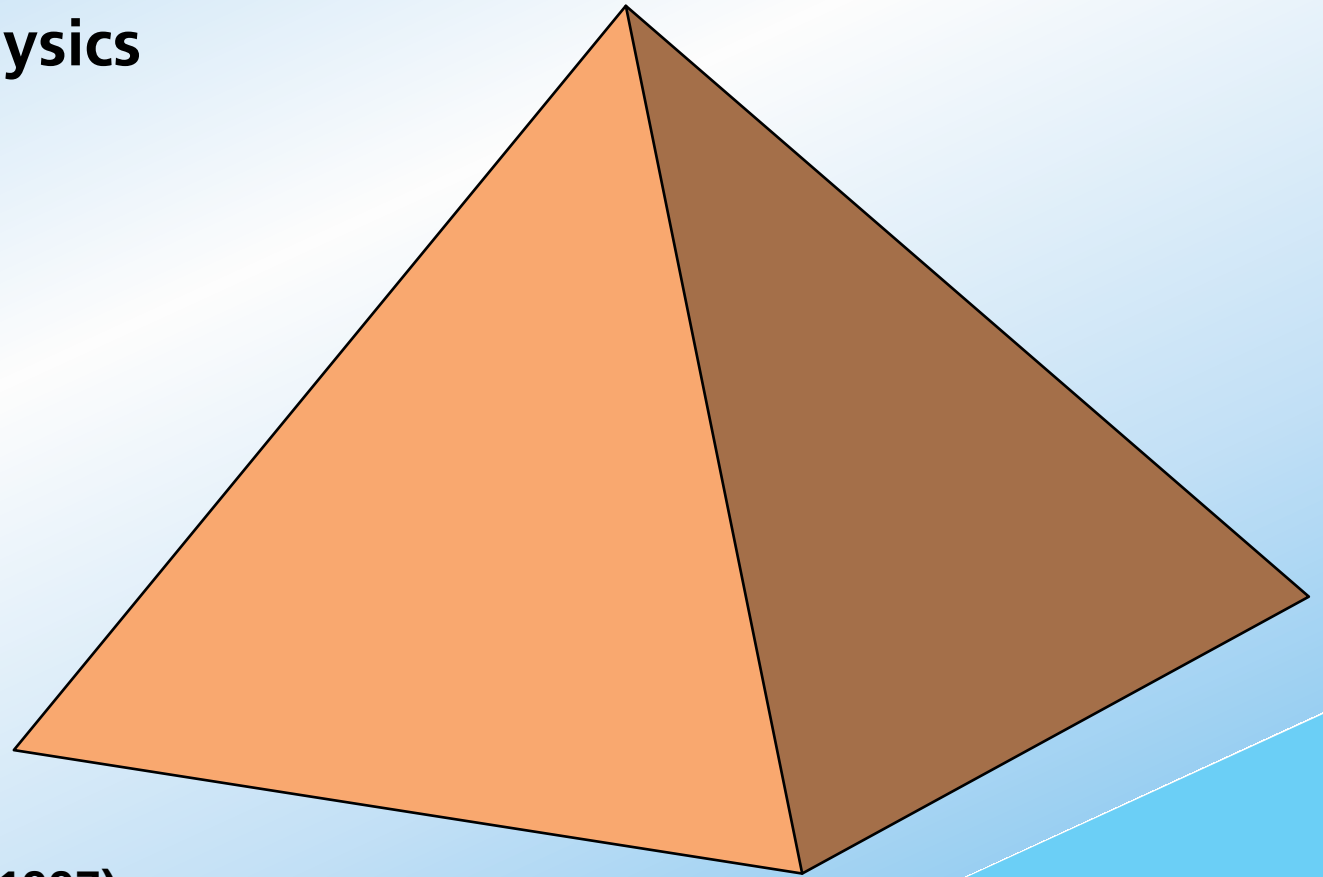

AIP Report R-151.33 (1997)

We have a problem

**about 1% of these get
a bachelor's degree
in physics**

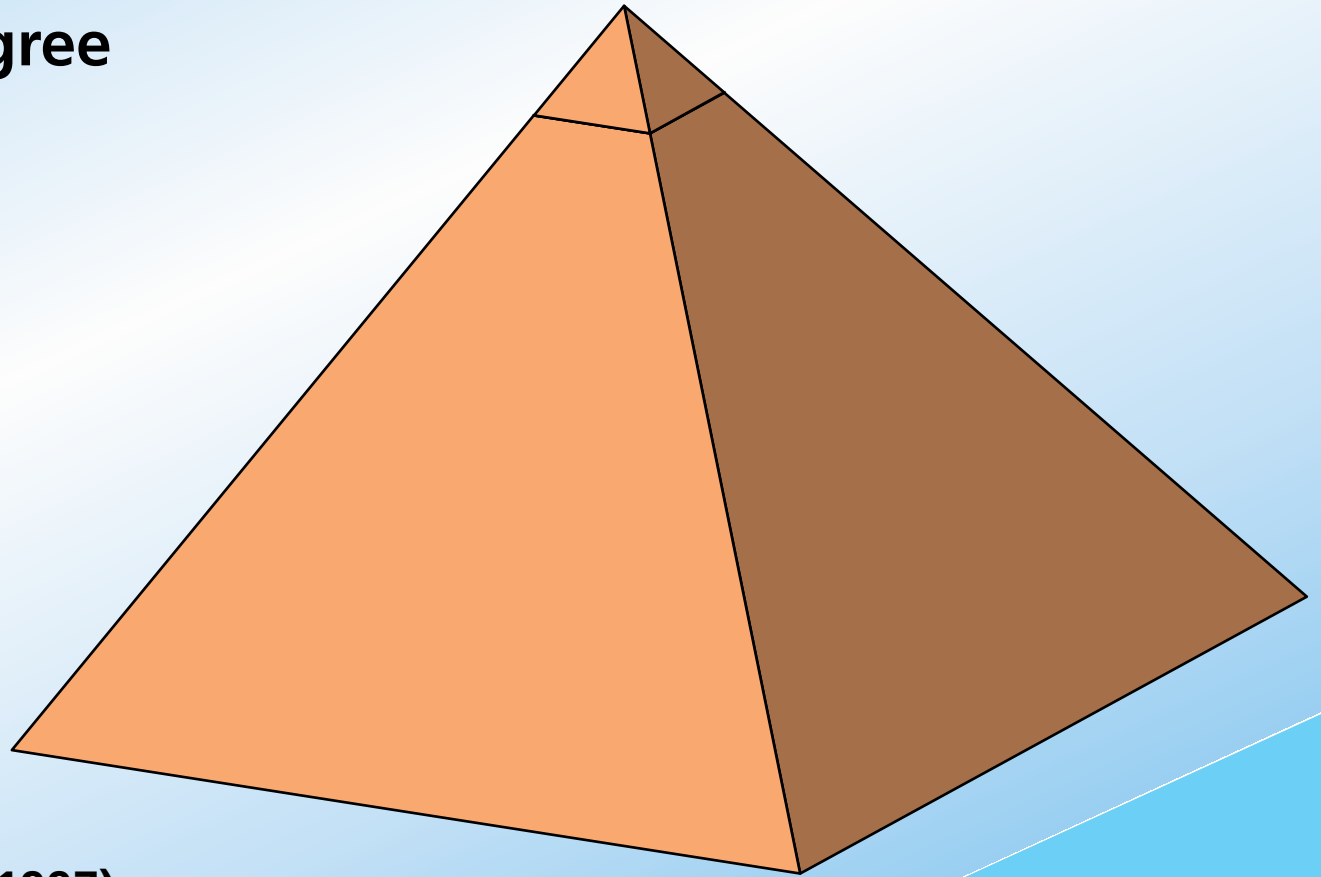

We have a problem

**Of the 4,300 students with
a bachelor's degree
in physics...**

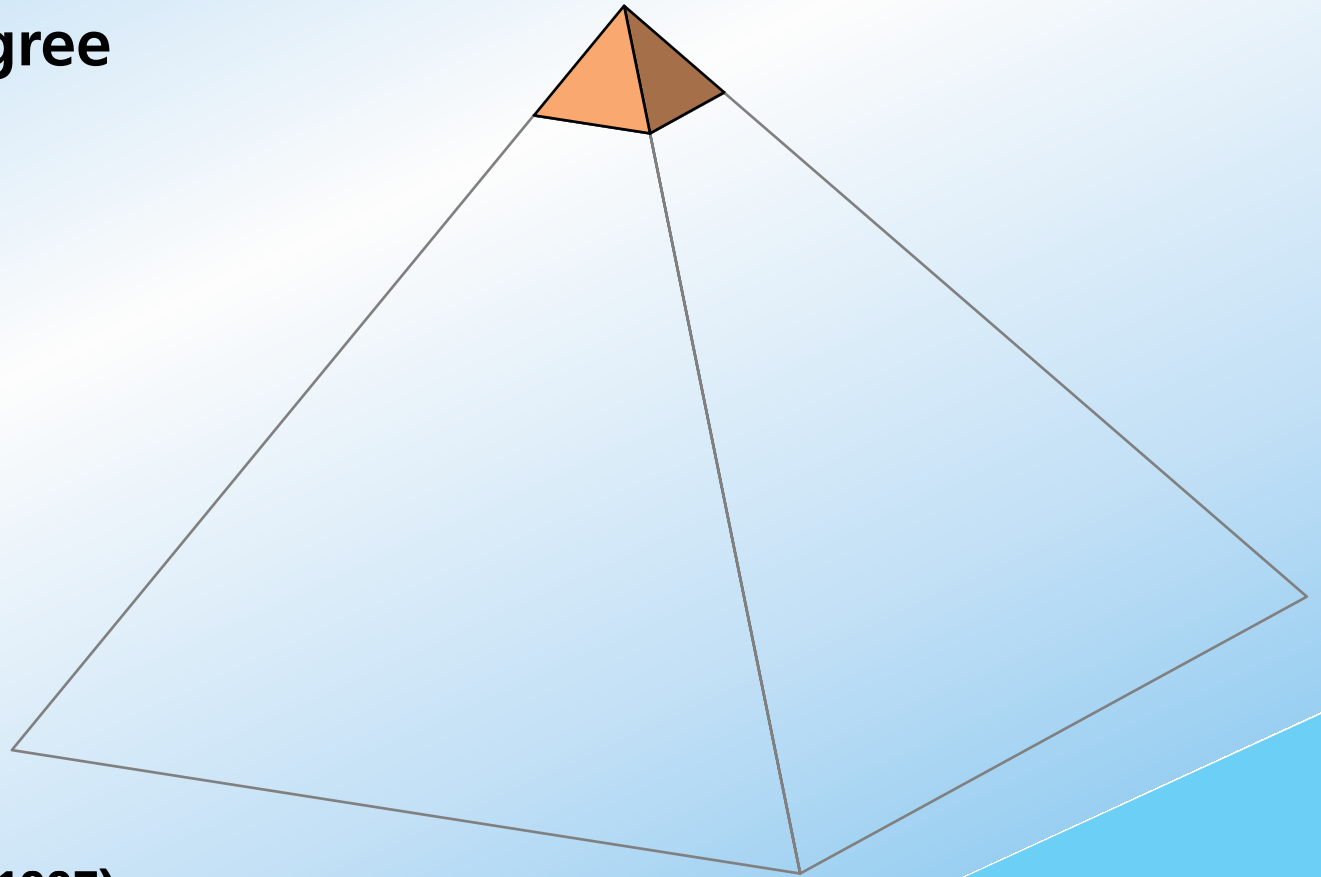

AIP Report R-151.33 (1997)

We have a problem

**about 35% go on to get a
Ph.D. in physics...**

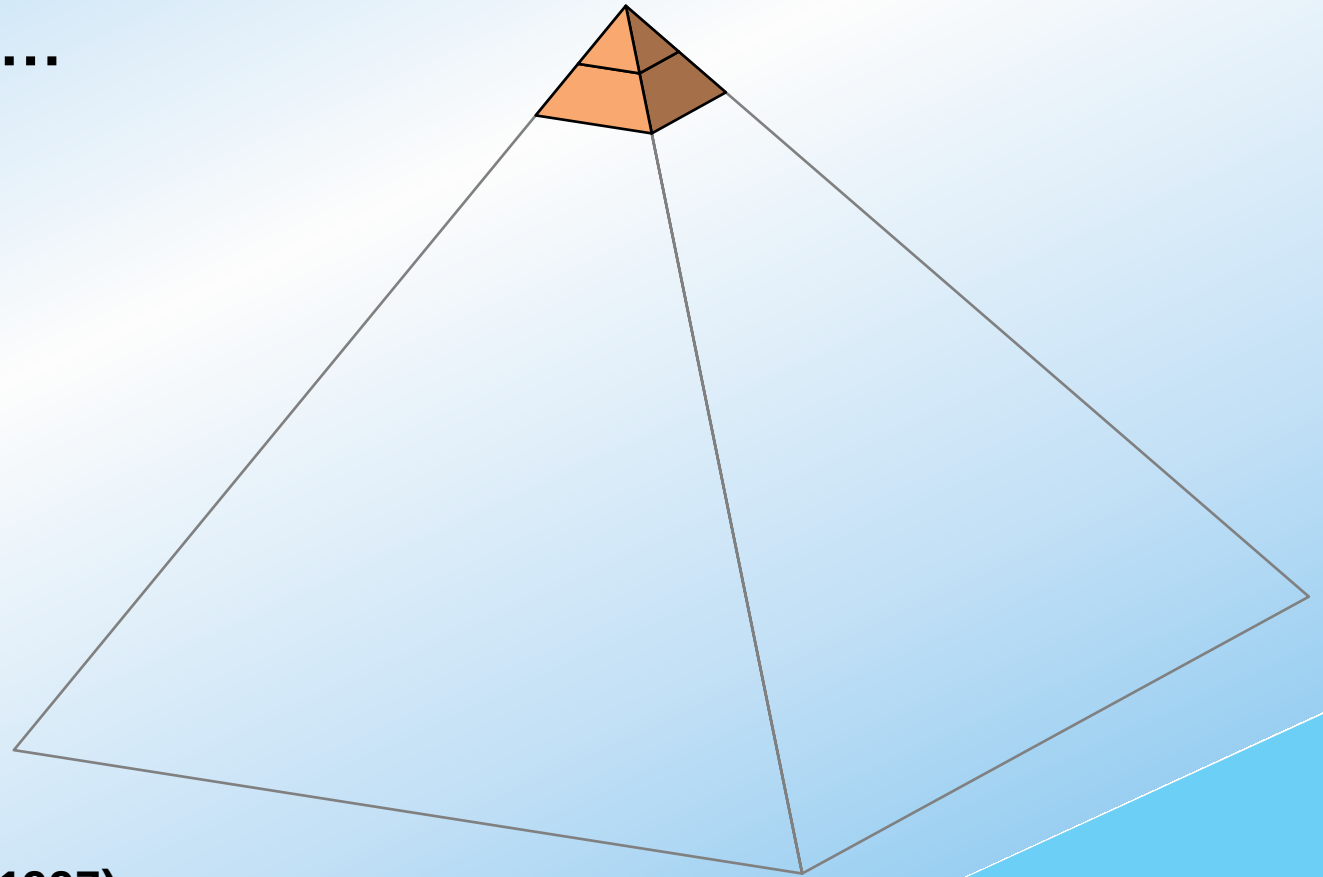

AIP Report R-151.33 (1997)

We have a problem

**That's one out of every
260 students in our
introductory
courses!**

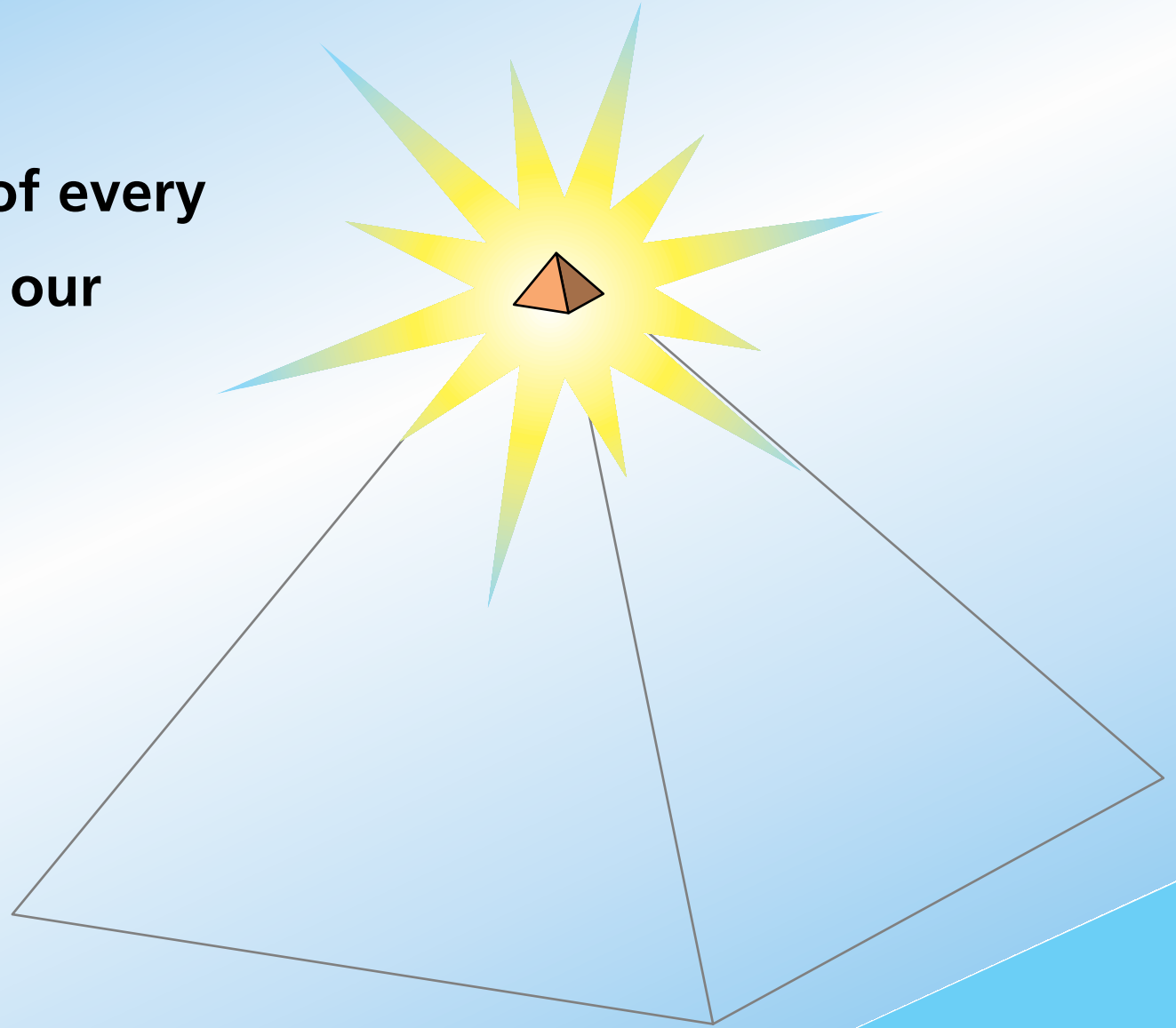

We have a problem

**What about the
other 259...?**

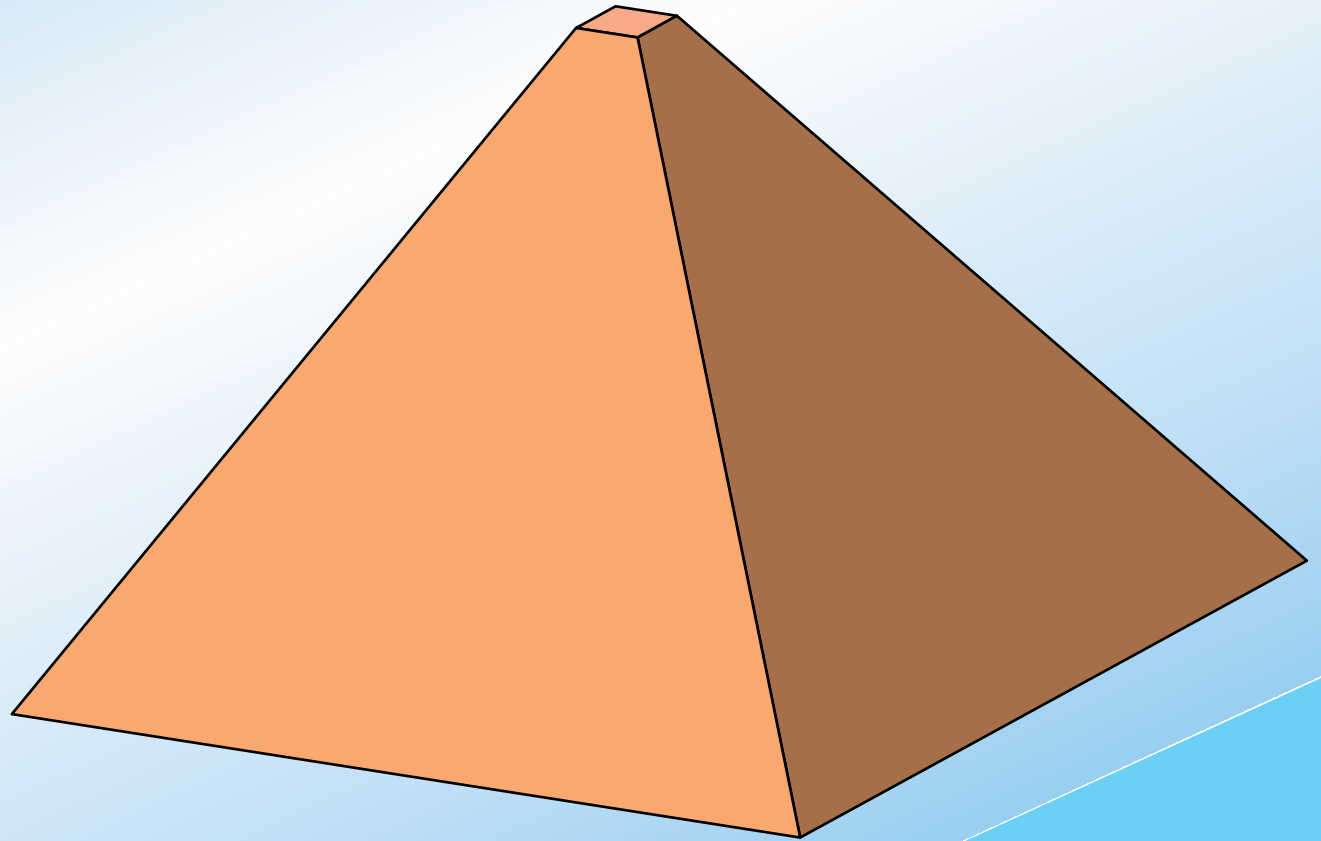

We have a problem

**What do we know
about these
students?**

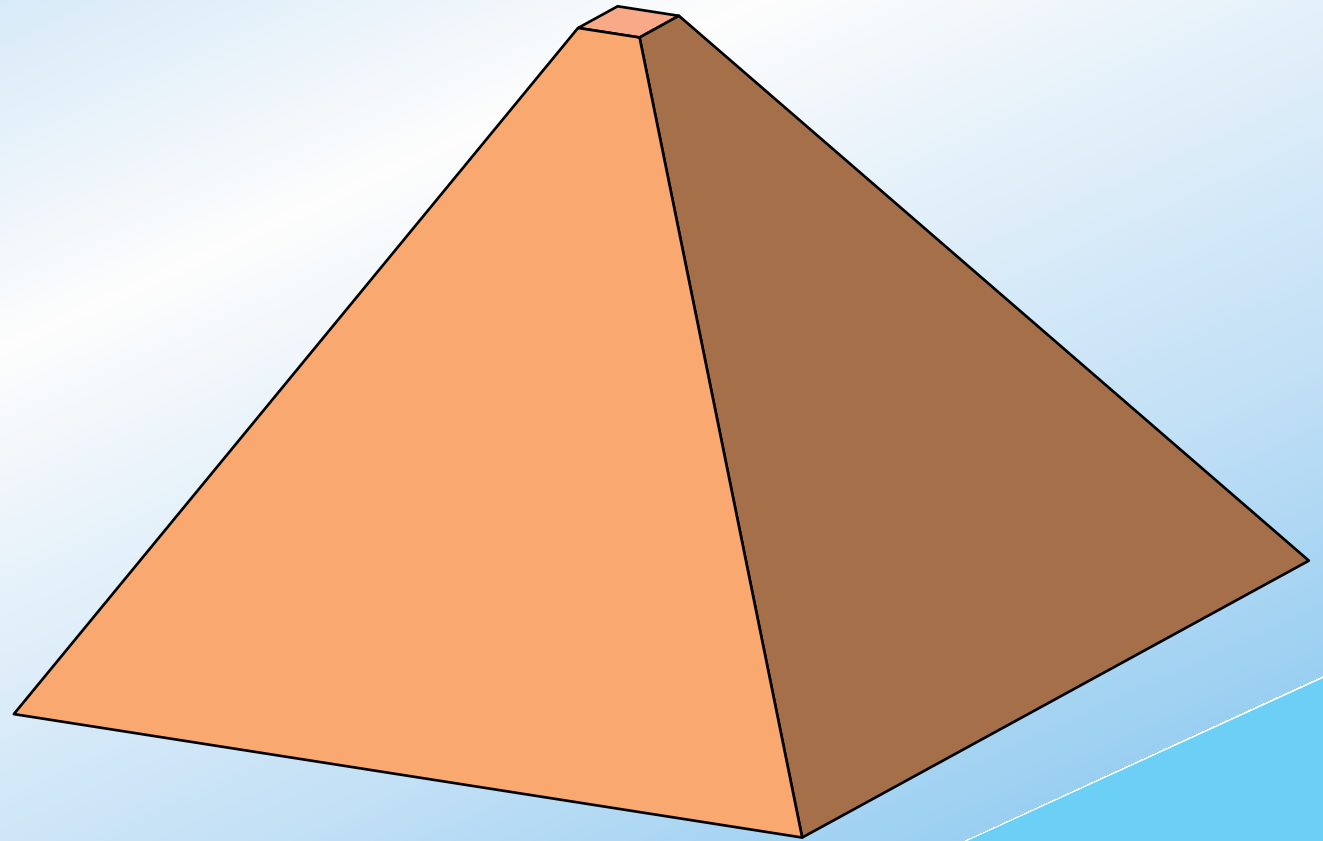

We have a problem

Some disturbing symptoms:

- ▶ **frustration**
- ▶ **lack of understanding**
- ▶ **lack of basic knowledge**

We have a problem

They know the jargon:

- ▶ **circular motion**
- ▶ **barometric pressure**
- ▶ **light radius**
- ▶ **something to the power times ten to the something**

We have a problem

They are aware of their lack of knowledge

- ▶ **I graduated from college but I didn't study *astronomy***
- ▶ **It's been a while since I've had physics**

We have a problem

They are aware of their lack of knowledge

- ▶ **I graduated from college but I didn't study *astronomy***
- ▶ **It's been a while since I've had physics**

...and they don't care!

We have a problem



We have a problem



**Math suks (math suks),
Math suks (math suks)
I'd like to burn this text book
I hate that stuff so much
Math suks (math suks),
Math suks (math suks)**

Jimmy Buffett
*on **Beach House on the Moon***

We have a problem



I don't know and I don't care

**Another song by Jimmy Buffett
on *Beach House on the Moon***

We have a problem

Should we worry?

We have a problem

We'd better!

We have a problem

"I took four years of science and four years of math...

**A waste of my time,
a waste of the teacher's time,
and a waste of space...**

**You know,
I took *physics*.**

For *what?*"





Why do we have this problem?

Why do we have this problem?

- ▶ **Lectures focus on transfer of information...**

Why do we have this problem?

- ▶ **Lectures focus on transfer of information...**
(but education is more than information)

Why do we have this problem?

- ▶ **Lectures focus on transfer of information...**
(but education is more than information)

- ▶ **Conventional problems reinforce bad study habits**

Why do we have this problem?

Conventional problems reinforce bad study habits

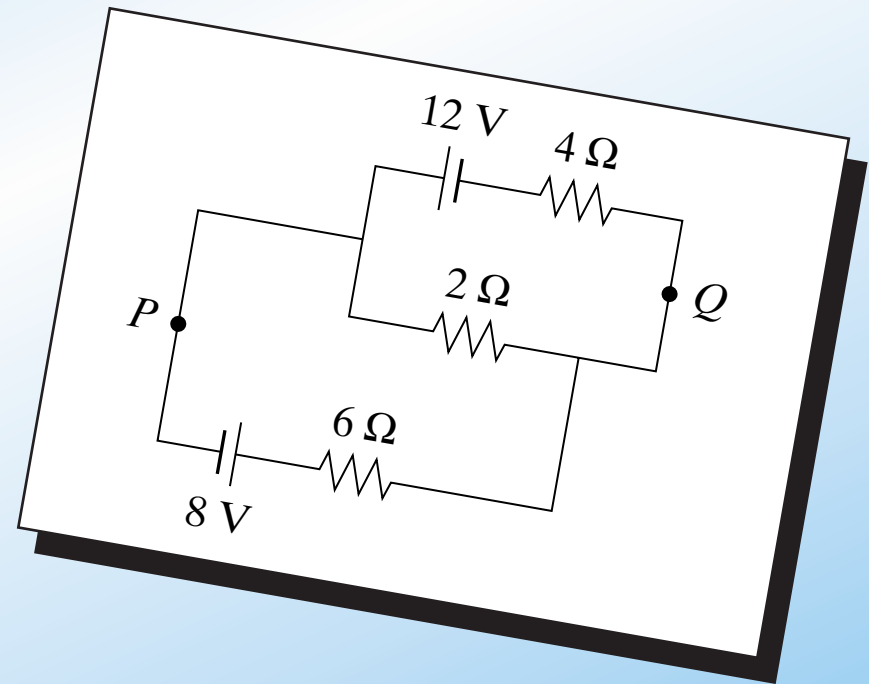

Why do we have this problem?

Conventional problems reinforce bad study habits

Calculate:

- (a) the current in the $2\text{-}\Omega$ resistor, and
- (b) the potential difference between points P and Q

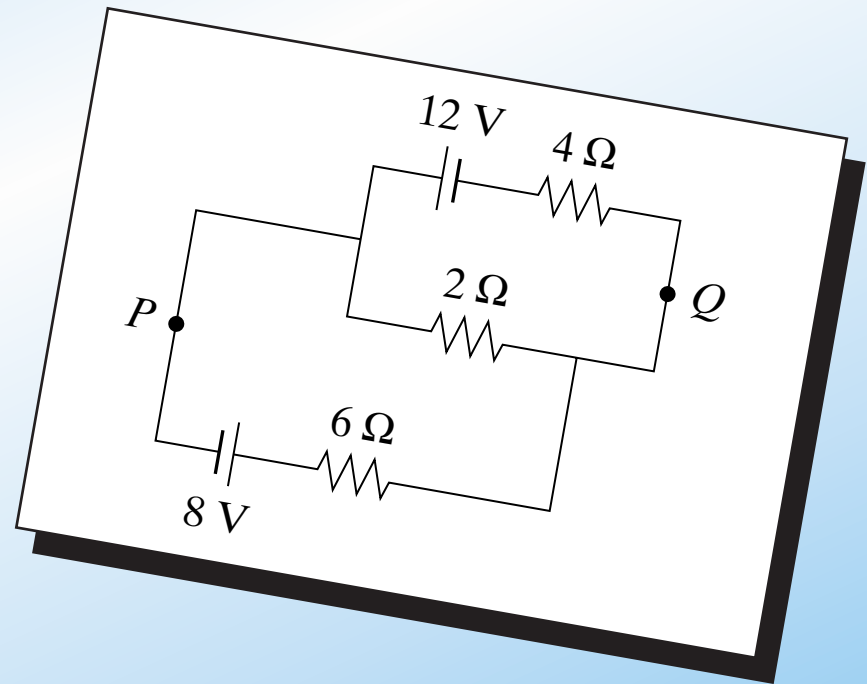

Why do we have this problem?

Are basic principles understood?

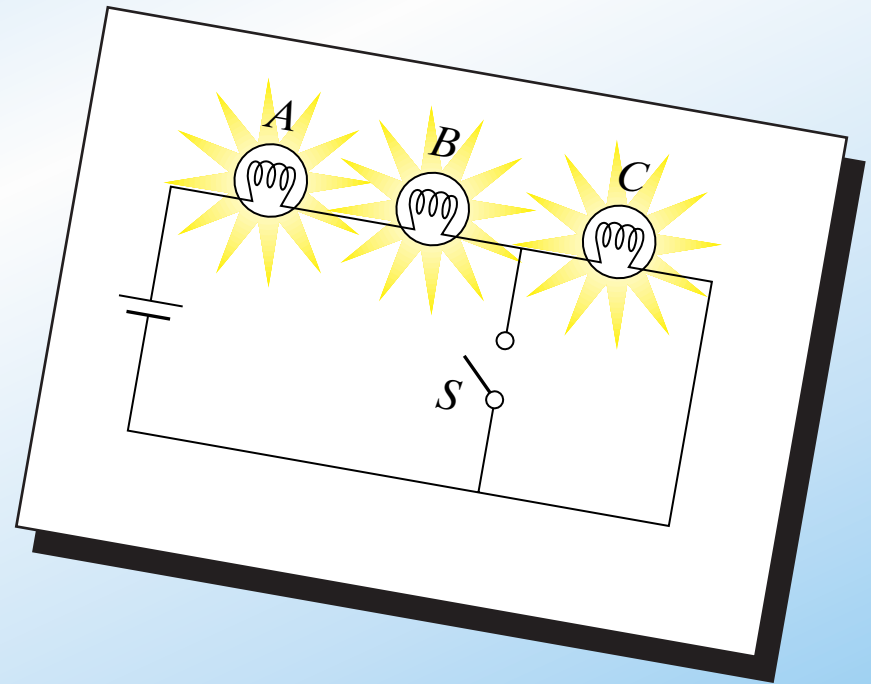

Why do we have this problem?

Are basic principles understood?

When S is closed, what happens to the:

- (a) intensities of A and B ?
- (b) intensity of C ?
- (c) current through battery?
- (d) voltage drop across A , B , and C ?
- (e) total power dissipated?

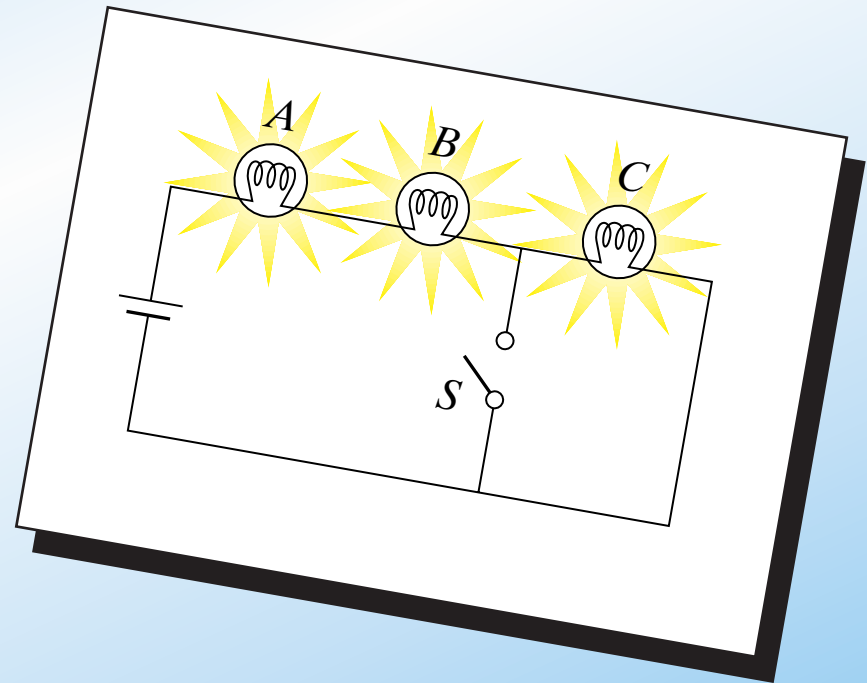

Why do we have this problem?

conventional

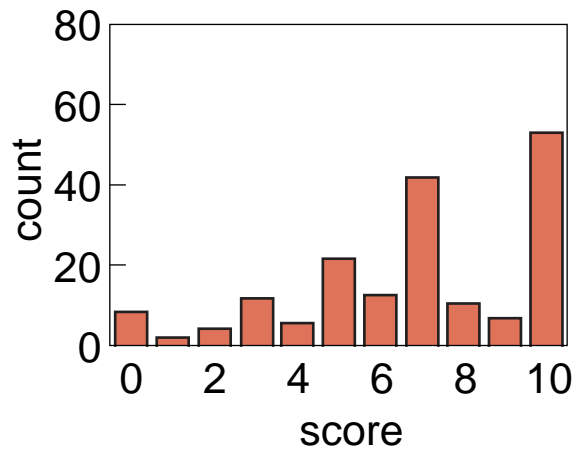

conceptual

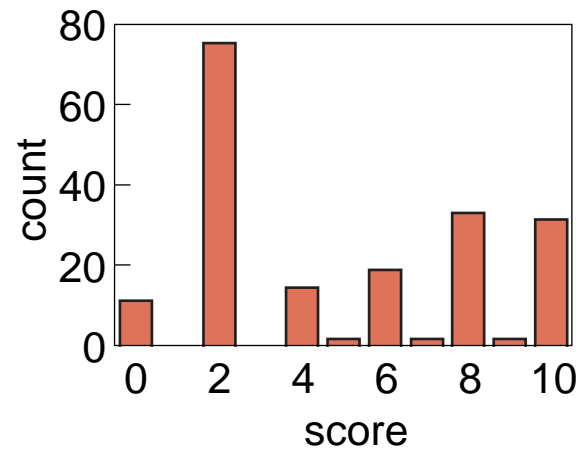

Why do we have this problem?

conventional

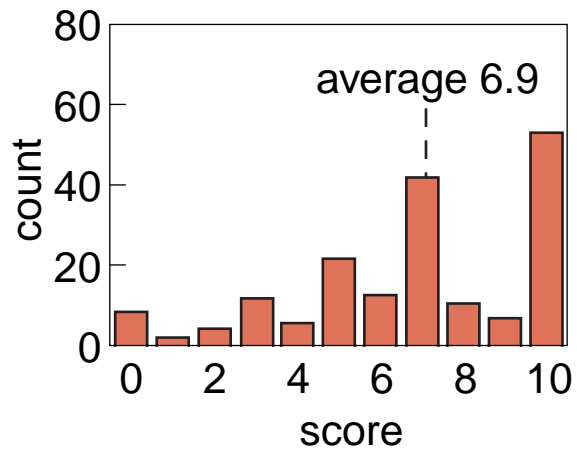

conceptual

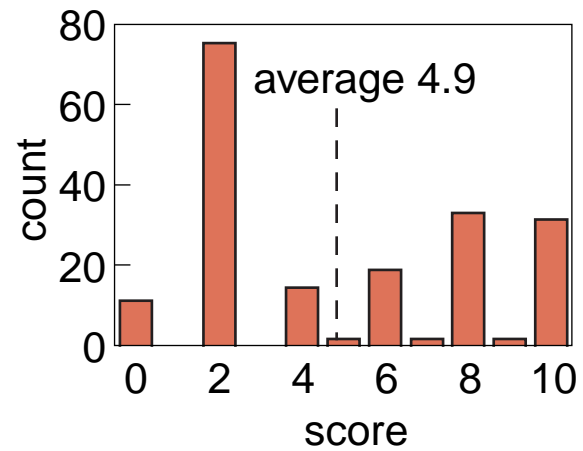

Why do we have this problem?

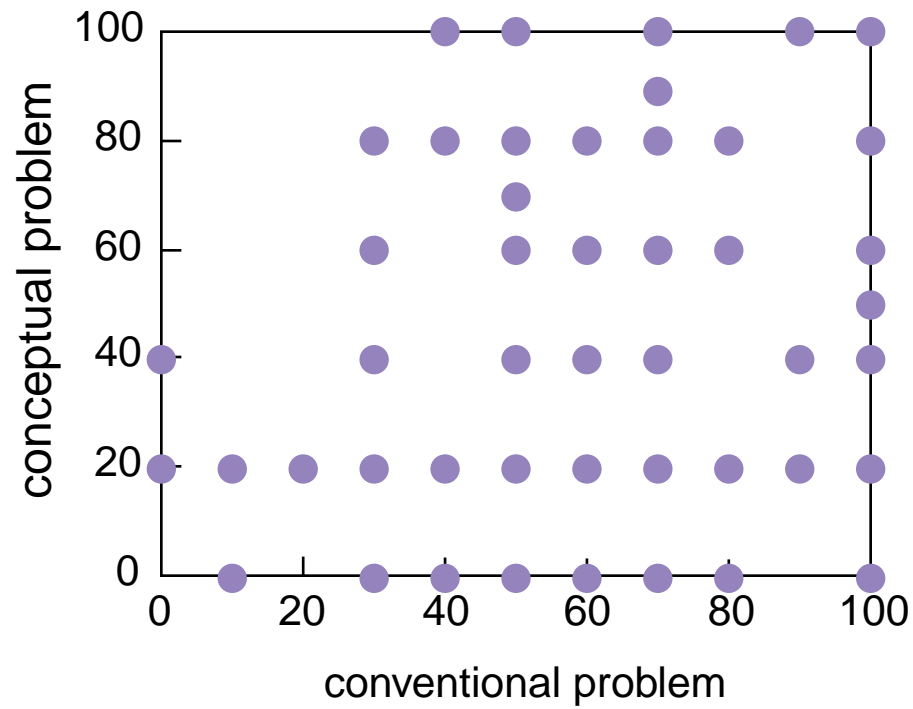

Why do we have this problem?

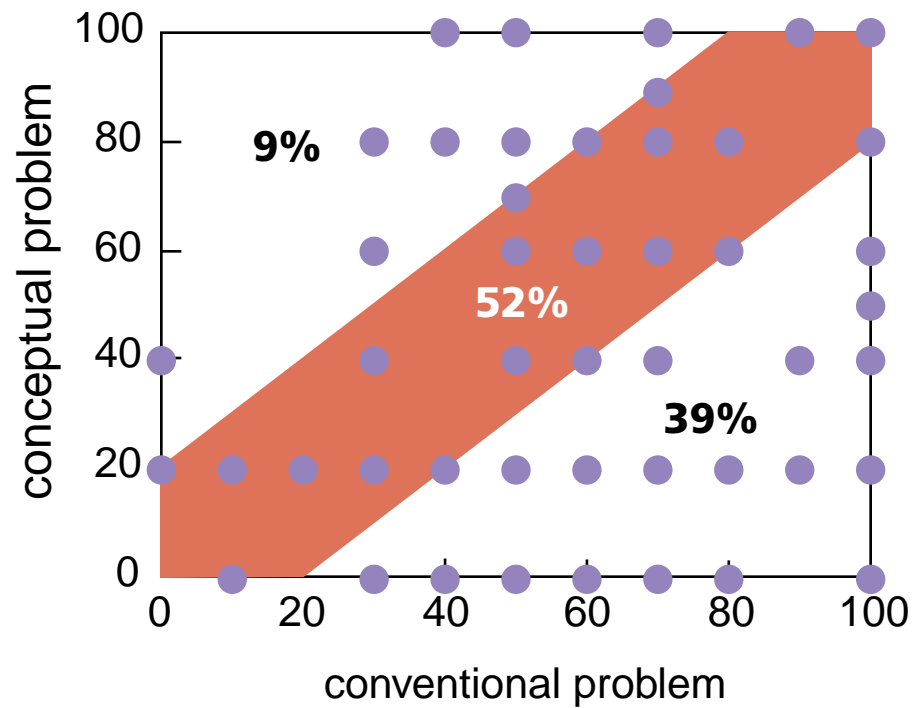

A wide-angle photograph of a large lecture hall. The room is filled with students seated at desks, facing a stage. On the stage, a lecturer is standing at a podium, and another person is visible further back. A large projection screen at the front of the room displays text and a diagram. The text on the screen includes the heading "What are the following..." followed by several bullet points. The room has a curved wall and a dark ceiling. The overall atmosphere is that of a formal academic setting.

So what should we do?

What should we do?

**Let's not forget the base
of the pyramid!**

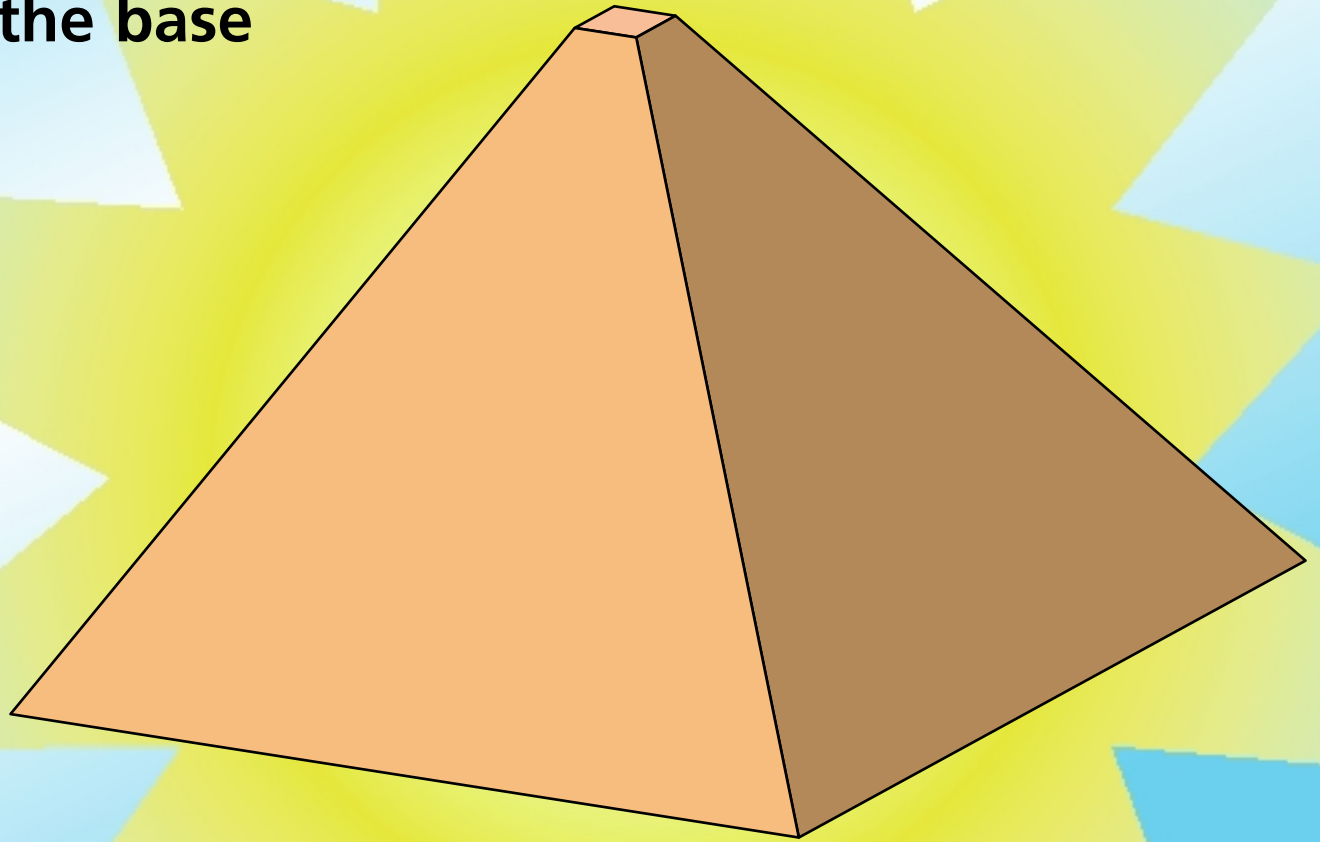

What should we do?

**Let's give them something
of value!**

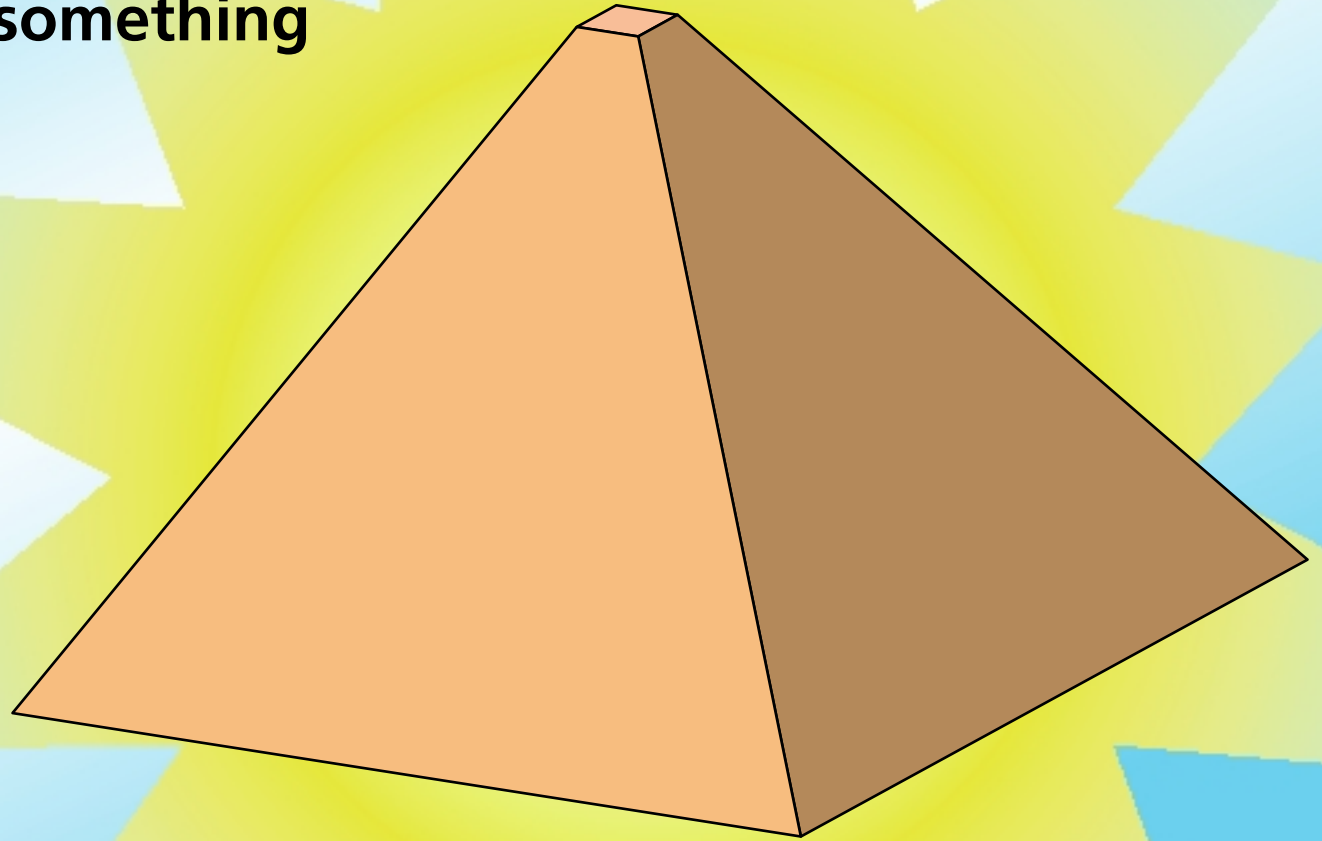

Peer Instruction

Help students take more responsibility for learning!

Peer Instruction

- ▶ **Move first exposure to the material out of the classroom...**

Peer Instruction

- ▶ **Move first exposure to the material out of the classroom: *assign reading!***

Peer Instruction

- ▶ **Move first exposure to the material out of the classroom: **assign reading!****
- ▶ **Use class to deepen and broaden understanding**

Peer Instruction

- ▶ **Move first exposure to the material out of the classroom: **assign reading!****
- ▶ **Use class to deepen and broaden understanding**
- ▶ **by identifying **key ideas****

Peer Instruction

- ▶ Move first exposure to the material out of the classroom: **assign reading!**
- ▶ Use class to deepen and broaden understanding
- ▶ by identifying **key ideas**
- ▶ and giving students opportunities to **think**

Peer Instruction

Main features:

- ▶ **Pre-class reading**

Peer Instruction

Main features:

- ▶ **Pre-class reading**
- ▶ **In class: depth, not coverage**

Peer Instruction

Main features:

- ▶ **Pre-class reading**
- ▶ **In class: depth, not coverage**
- ▶ **ConcepTests**

Results

- ▶ **focus on concepts leads to better understanding**

Results

- ▶ **focus on concepts leads to better understanding**
- ▶ **better understanding leads to better problem solving**

Results

- ▶ **focus on concepts leads to better understanding**
- ▶ **better understanding leads to better problem solving**
- ▶ **less frustration, more satisfaction**

Results

- ▶ **focus on concepts leads to better understanding**
- ▶ **better understanding leads to better problem solving**
- ▶ **less frustration, more satisfaction**
- ▶ **no (hidden) gap between students' performance and instructor's expectation**

Some things to think about...

Some things to think about...

- ▶ **what is taught is not necessarily learned**

Some things to think about...

- ▶ **what is taught is not necessarily learned**
- ▶ **“good” problem solving doesn’t always indicate understanding**

Some things to think about...

- ▶ **what is taught is not necessarily learned**
- ▶ **“good” problem solving doesn’t always indicate understanding**
- ▶ **there are many ready-to-implement solutions**

Some things to think about...

- ▶ **what is taught is not necessarily learned**
- ▶ **“good” problem solving doesn’t always indicate understanding**
- ▶ **there are many ready-to-implement solutions**
- ▶ **we must act *now!***

Funding

National Science Foundation

**For a copy of this presentation and
additional information:**

<http://mazur-www.harvard.edu>