

# **UNDERSTANDING OR MEMORIZATION: ARE WE TEACHING THE RIGHT THING?**

**Eric Mazur**

Massachusetts Institute of Technology  
21 September 2000



# *Outline*

▶ **Problem**

# *Outline*

▶ **Problem**

▶ **Cause**

# *Outline*

▶ **Problem**

▶ **Cause**

▶ **Remedy**

# *We have a problem*

**380,000 students take  
introductory physics  
each year...**

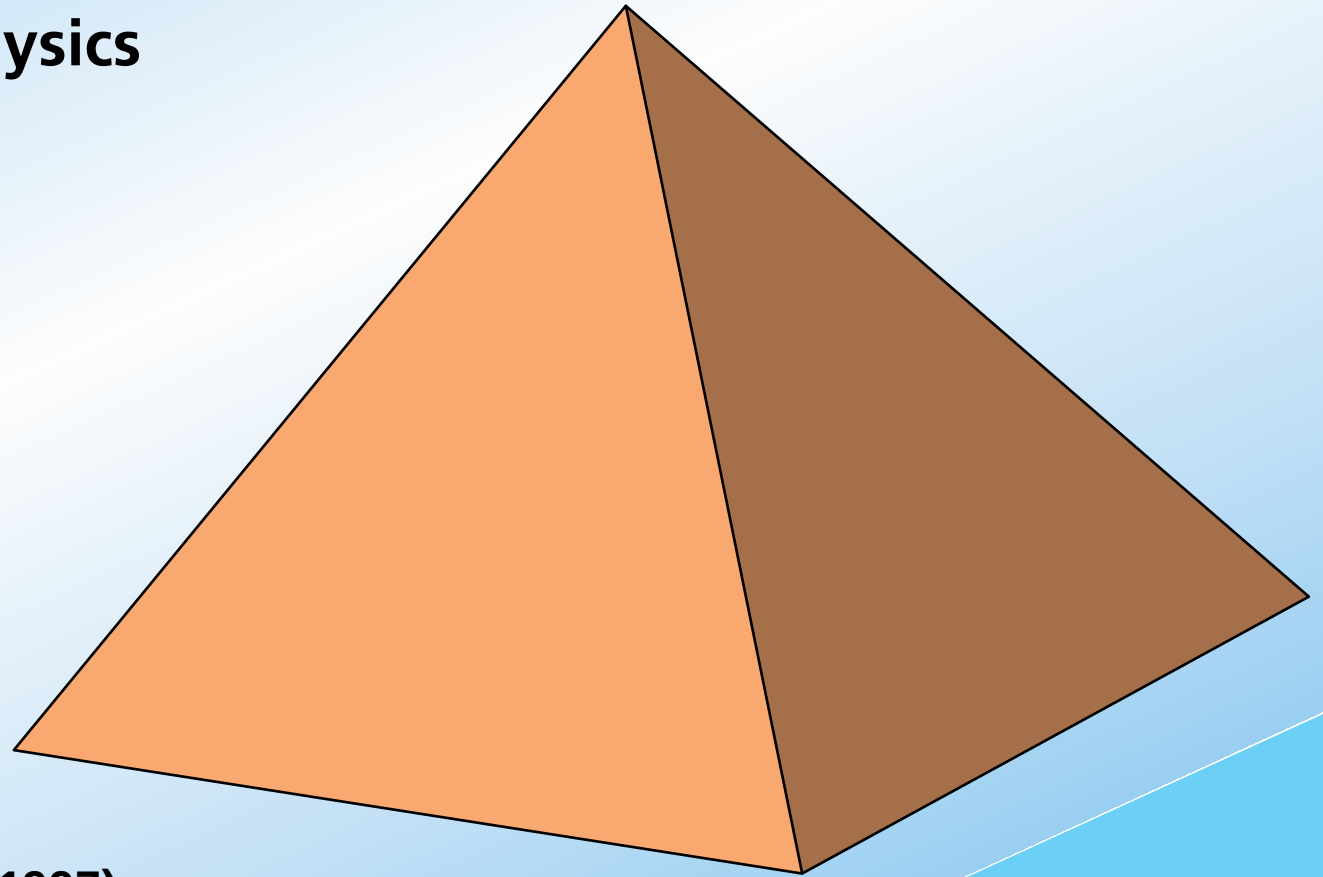

# *We have a problem*

**about 1% of these get  
a bachelor's degree  
in physics**

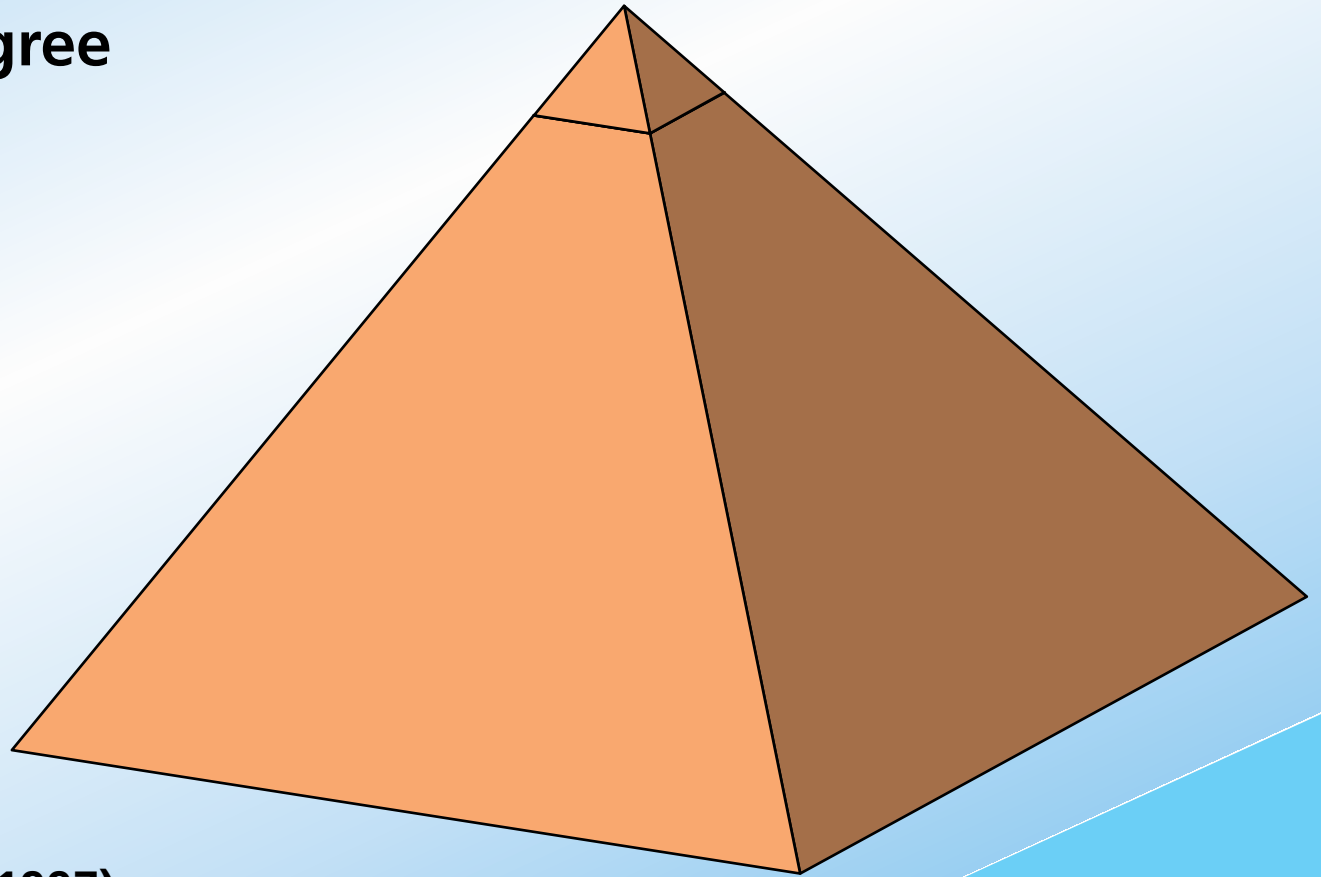

# *We have a problem*

**Of the 4,300 students with  
a bachelor's degree  
in physics...**

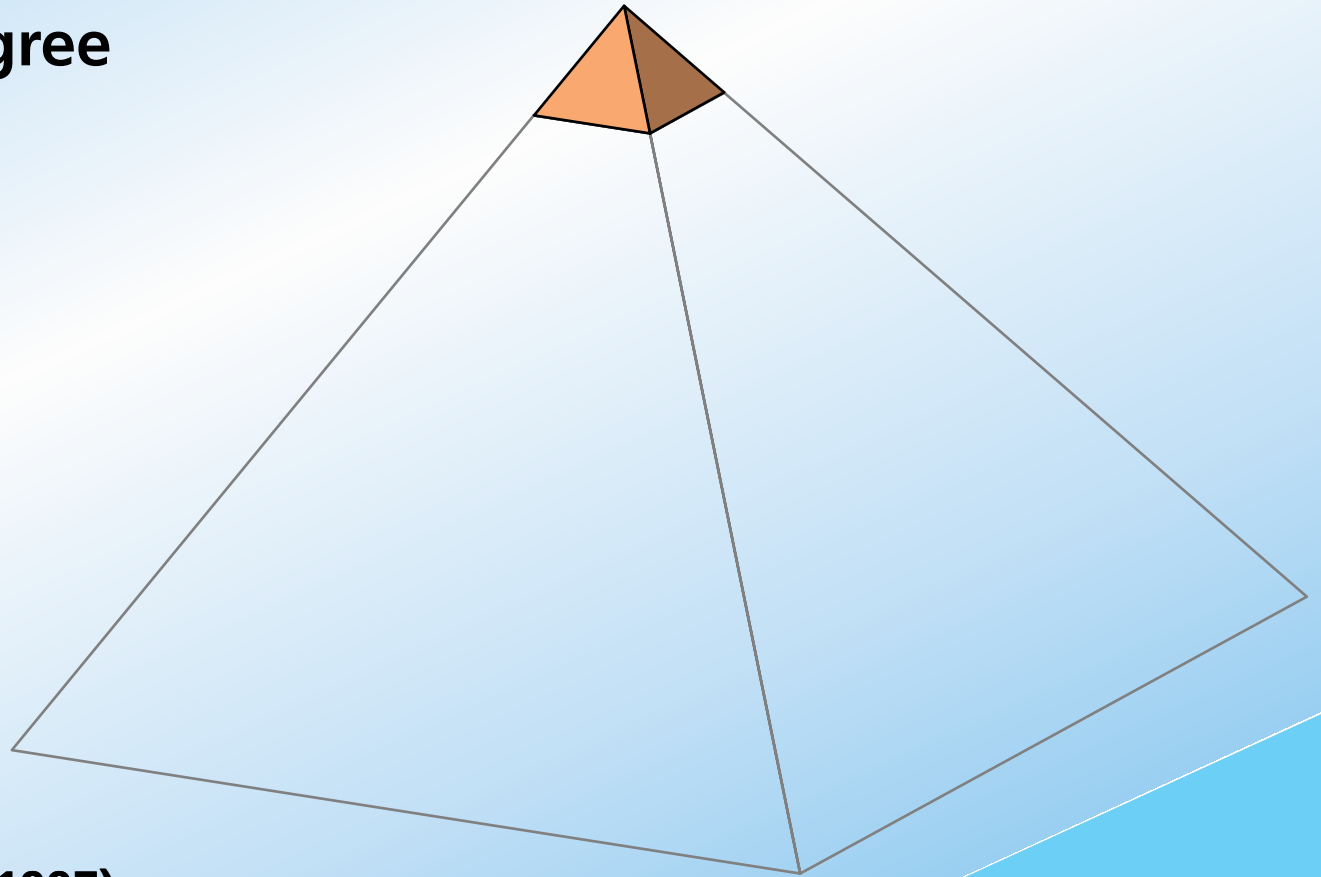

# *We have a problem*

**about 35% go on to get a  
Ph.D. in physics...**

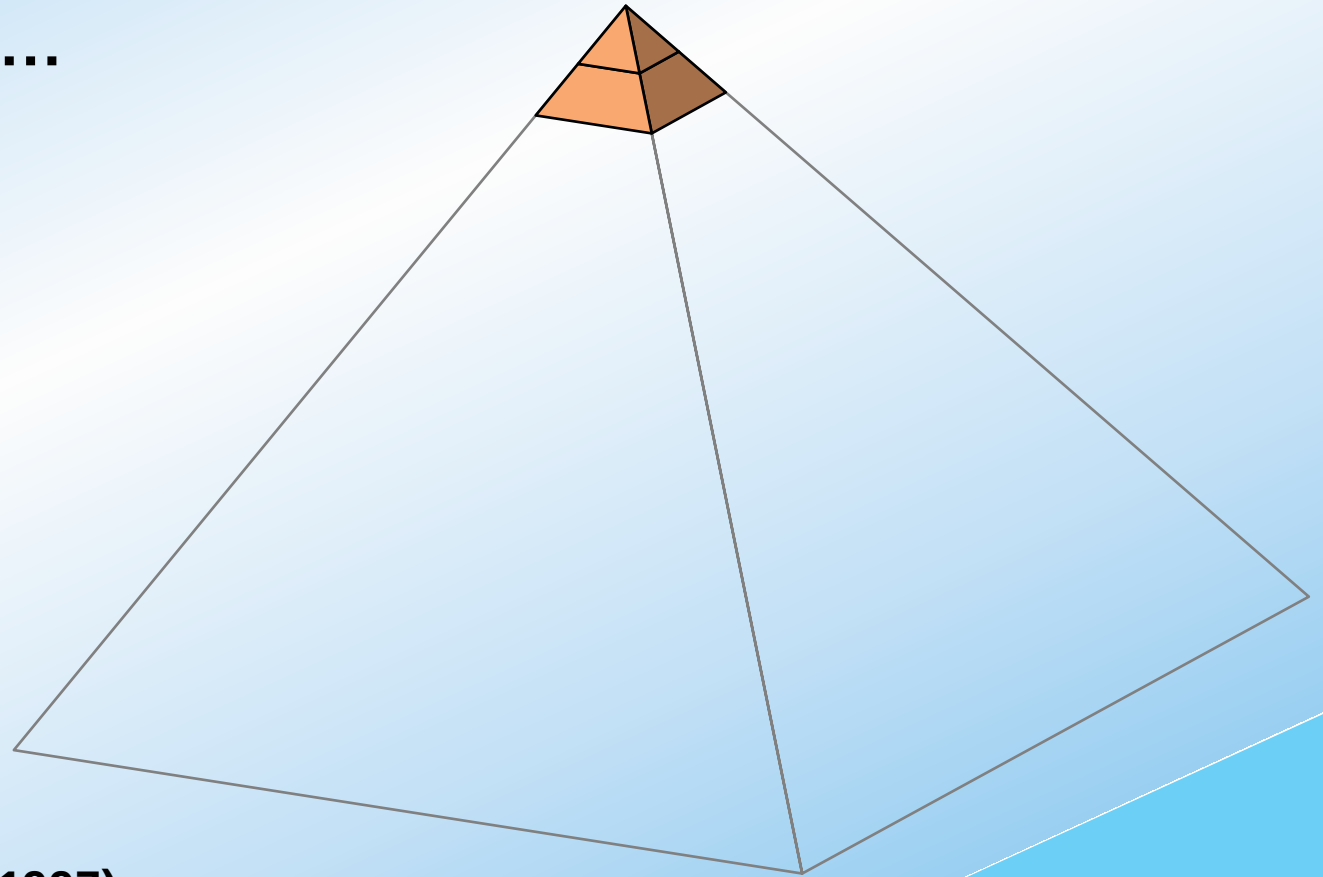

***AIP Report R-151.33 (1997)***



# *We have a problem*

**That's one out of every  
260 students in our  
introductory  
courses!**

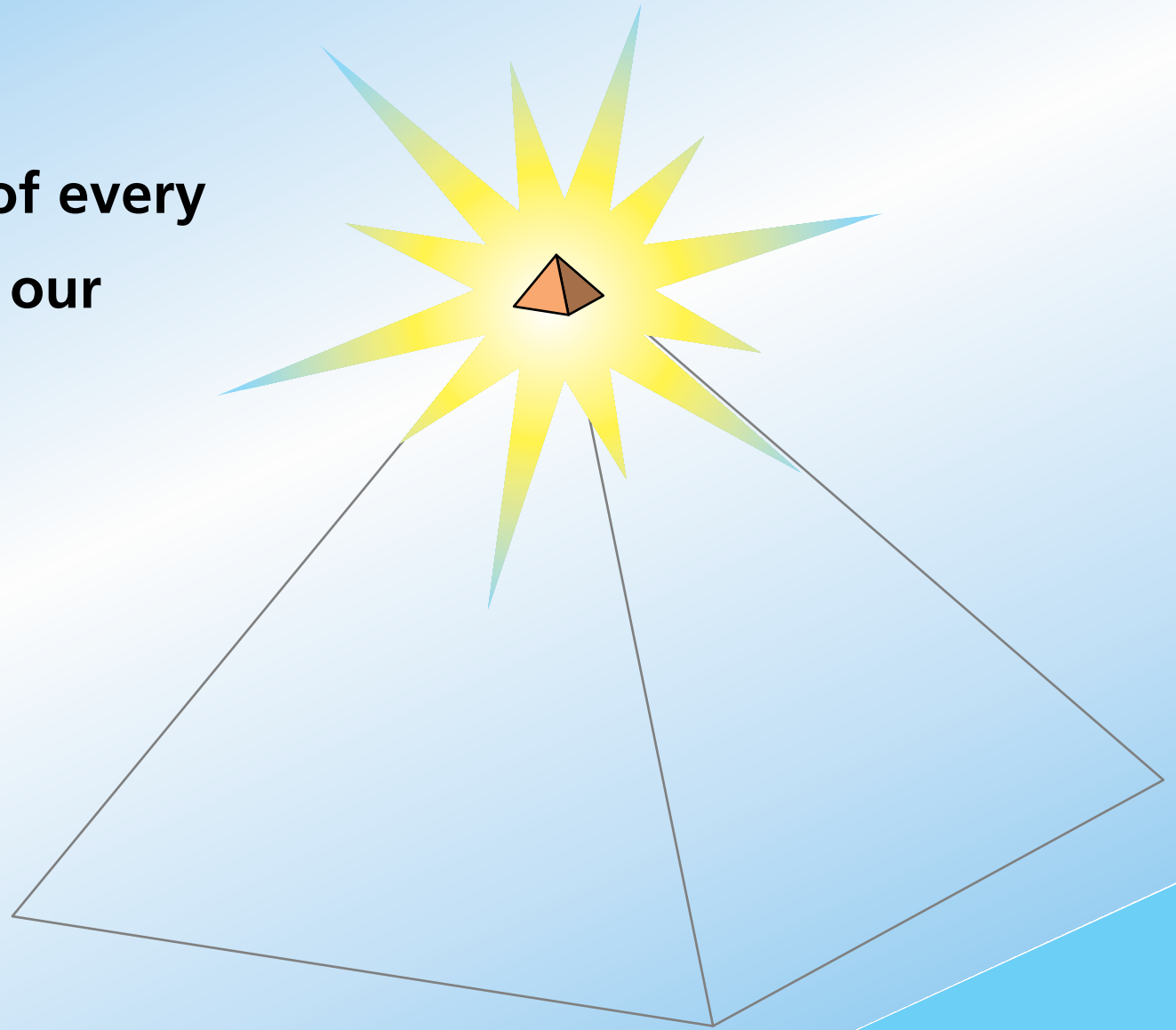

# *We have a problem*

**What about the  
other 259...?**

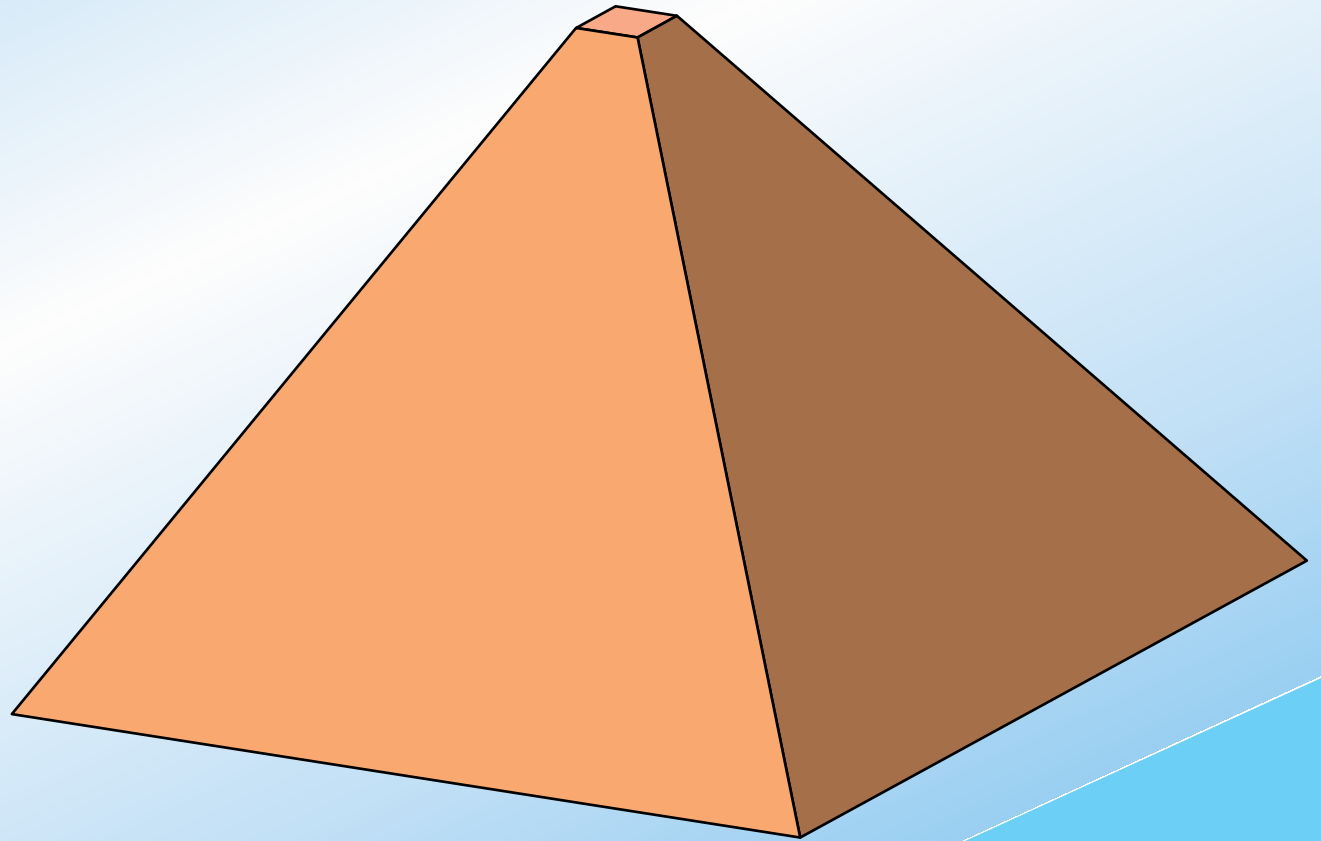

# *We have a problem*

**What do we know  
about these  
students?**

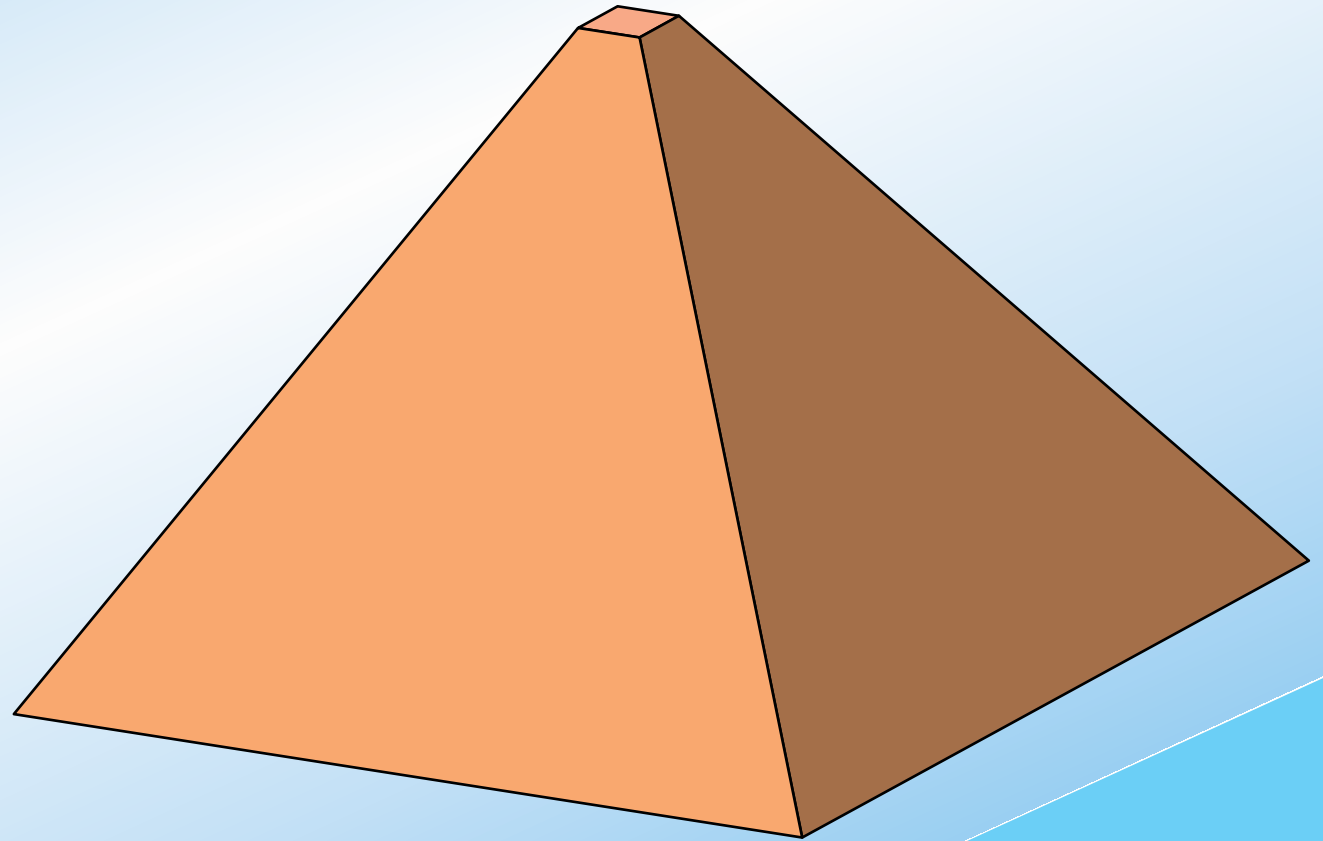

# *We have a problem*

## **Some disturbing symptoms:**

- ▶ **frustration**
- ▶ **lack of understanding**
- ▶ **lack of basic knowledge**



## *We have a problem*

**Well, “hot” is a relative term...**

**You see, given temperatures rise, regardless of mass.**

**Yeah, Galileo observed rising temperatures will decrease with the exposure of an endothermic source.**

**Endothermic?**

**True transience will persist until this one irresistible calorie interacts, thus altering the system.**

## *We have a problem*

**Well, “hot” is a relative term...**

**You see, given temperatures rise, regardless of mass.**

**Yeah, Galileo observed rising temperatures will decrease with the exposure of an endothermic source.**

**Endothermic?**

**True transience will persist until this one irresistible calorie interacts, thus altering the system.**

**Uh huh...**





# *We have a problem*

**They know the jargon:**

- ▶ **circular motion**
- ▶ **barometric pressure**
- ▶ **light radius**
- ▶ **something to the power times ten to the something**

## *We have a problem*

**They are aware of their lack of knowledge**

- ▶ **I graduated from college but I didn't study *astronomy***
- ▶ **It's been a while since I've had physics**

## *We have a problem*

**They are aware of their lack of knowledge**

- ▶ **I graduated from college but I didn't study *astronomy***
- ▶ **It's been a while since I've had physics**

**...and they don't care!**

*We have a problem*

**Should we worry?**

*We have a problem*

**We'd better!**



## *We have a problem*

**"I took four years of science and four years of math...**

**A waste of my time,  
a waste of the teacher's time,  
and a waste of space...**

**You know,  
I took *physics*.**

**For *what?*"**





**Why do we have this problem?**



## *Why do we have this problem?*

**Lectures focus on transfer of information...**

# Why do we have this problem?

...but physics is not just information!

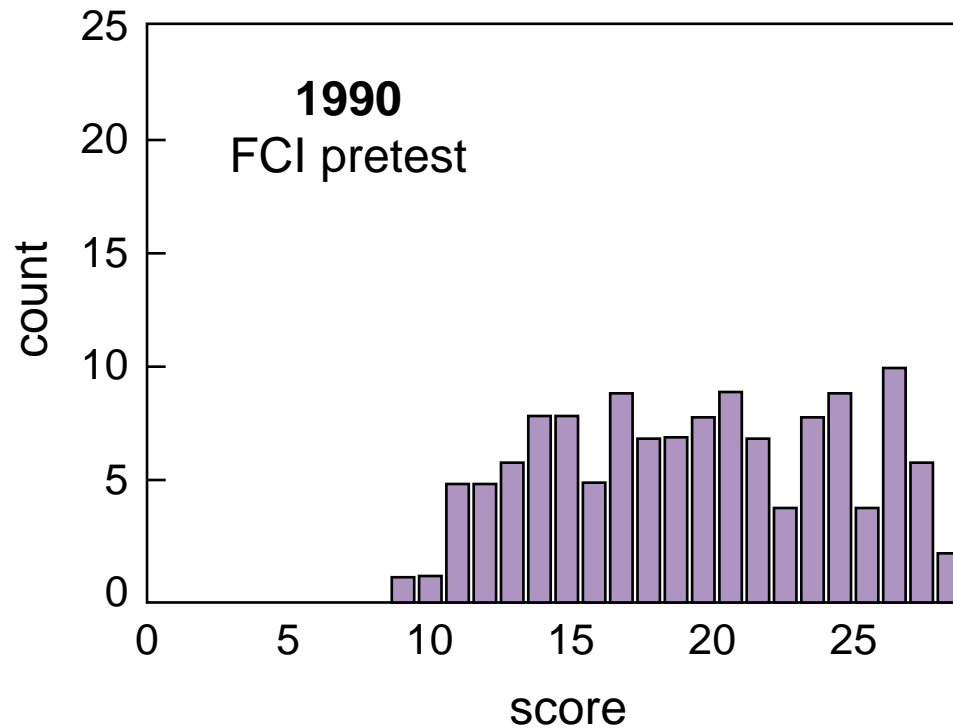

# *Why do we have this problem?*

...but physics is not just information!

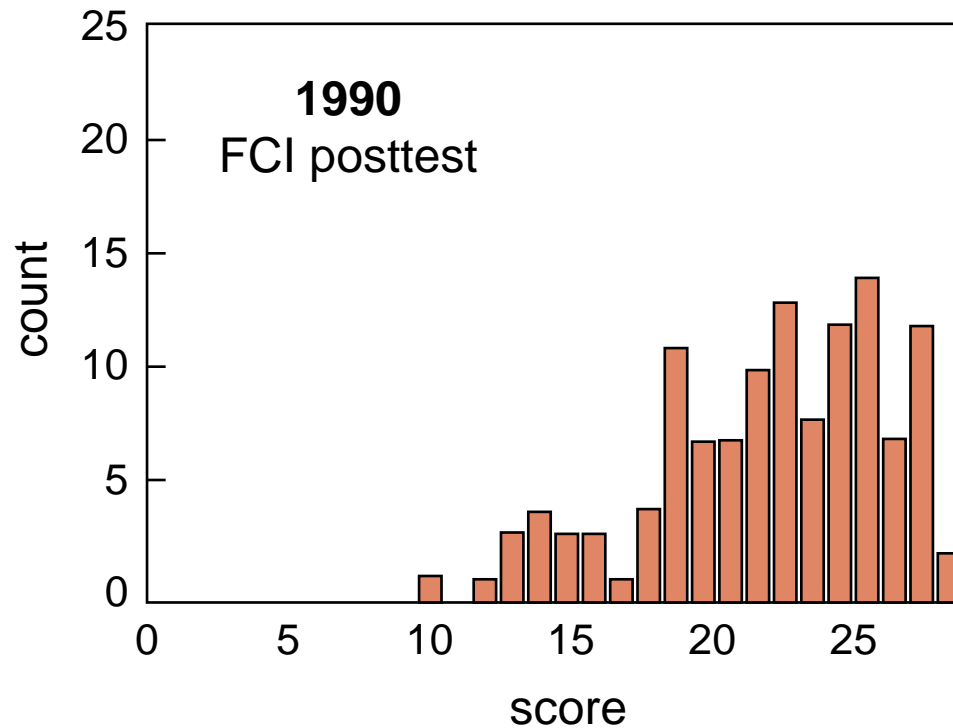

# *Why do we have this problem?*

**...but physics is not just information!**

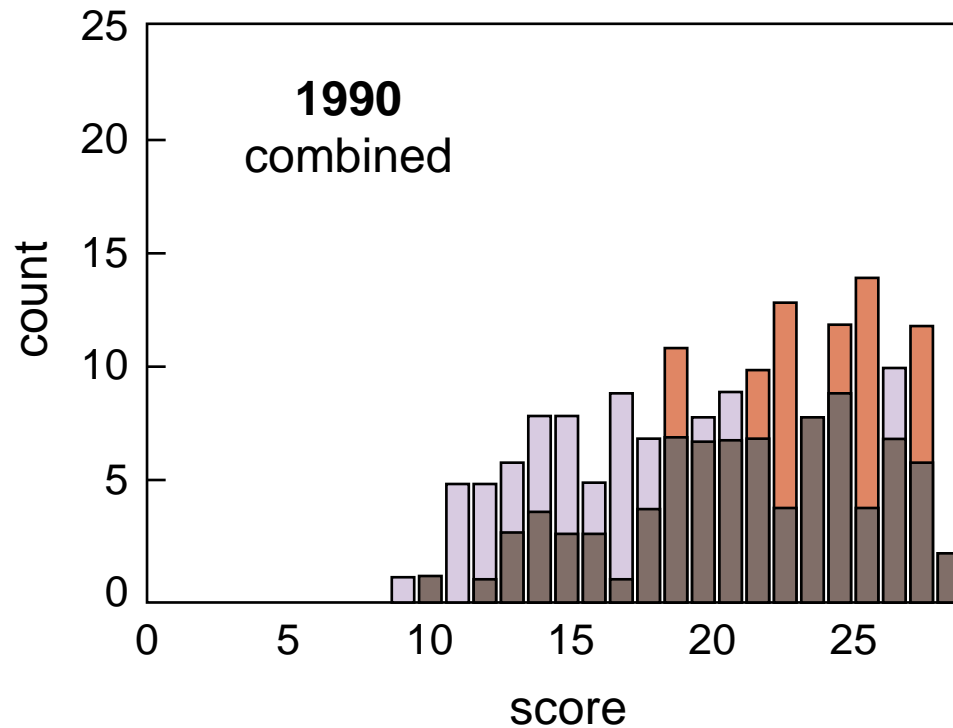

# Why do we have this problem?

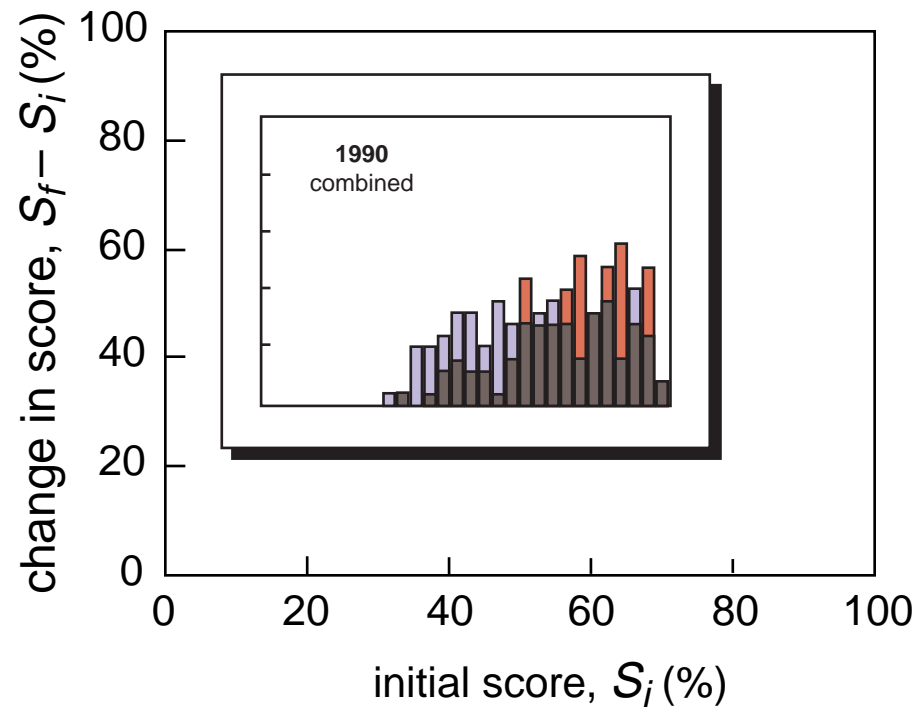

# Why do we have this problem?

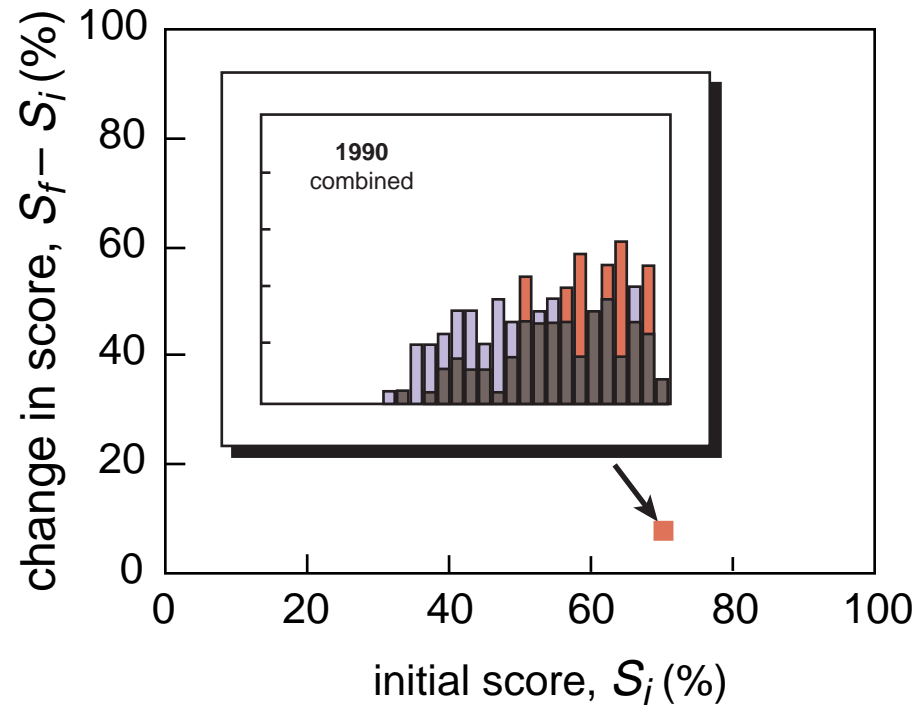

# Why do we have this problem?

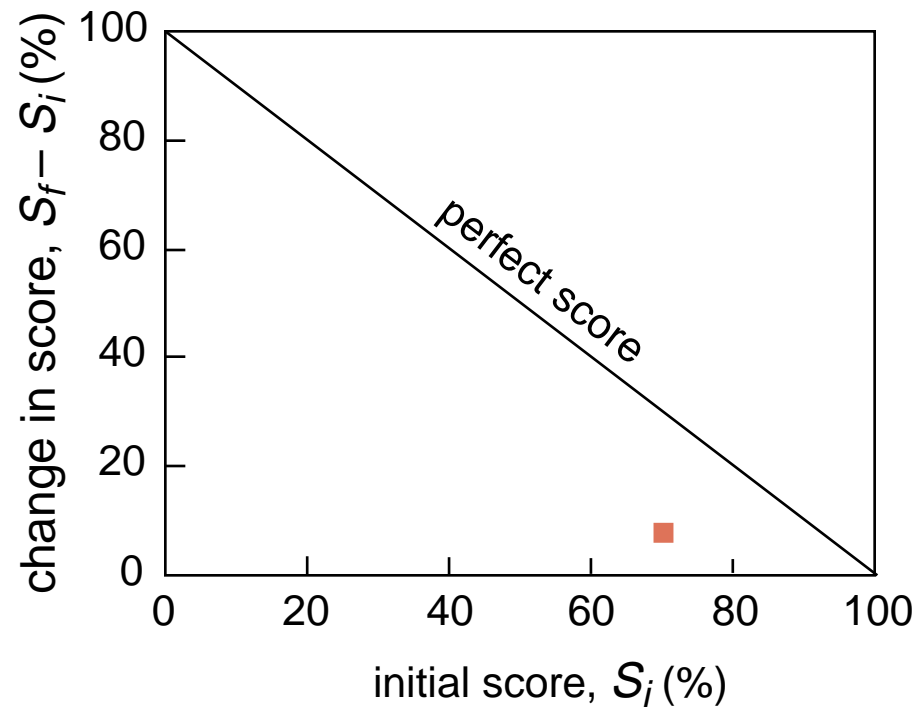

# Why do we have this problem?

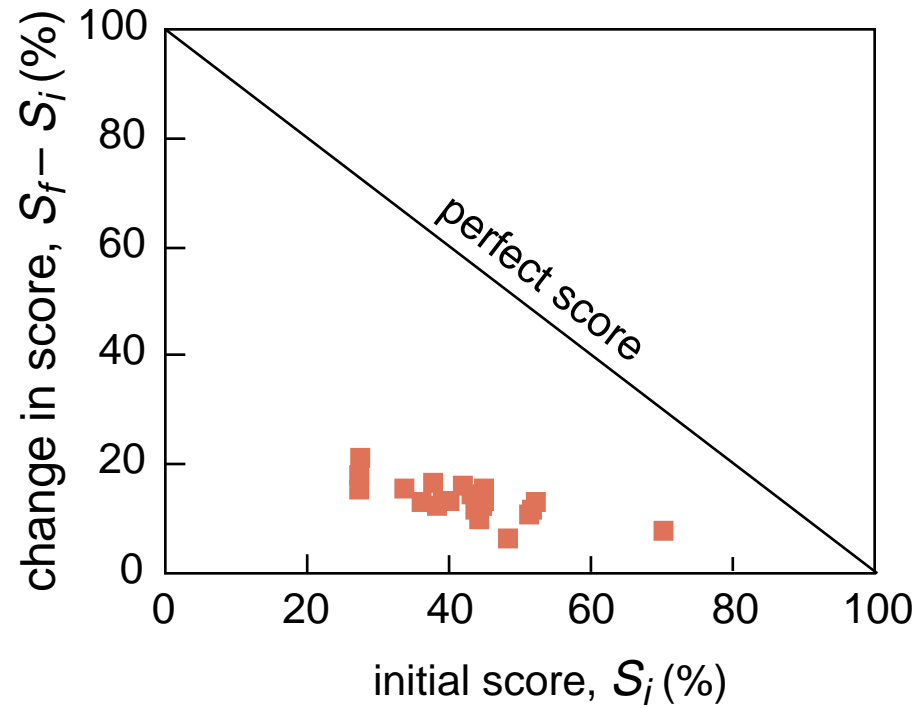



# Why do we have this problem?

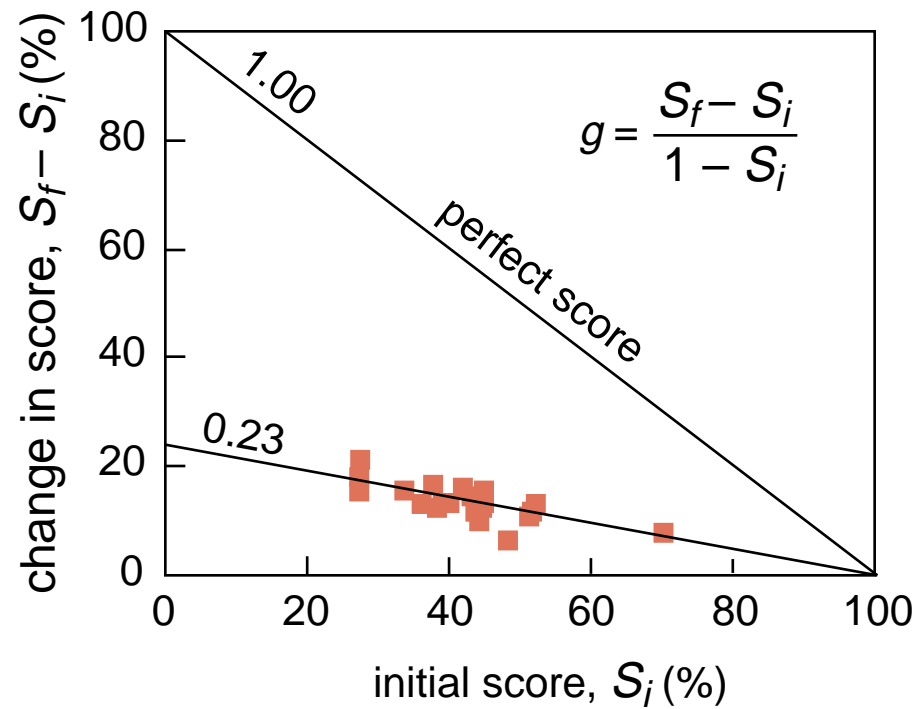

## *Why do we have this problem?*

**Conventional problems reinforce bad study habits**

## *Why do we have this problem?*

**Conventional problems reinforce bad study habits**

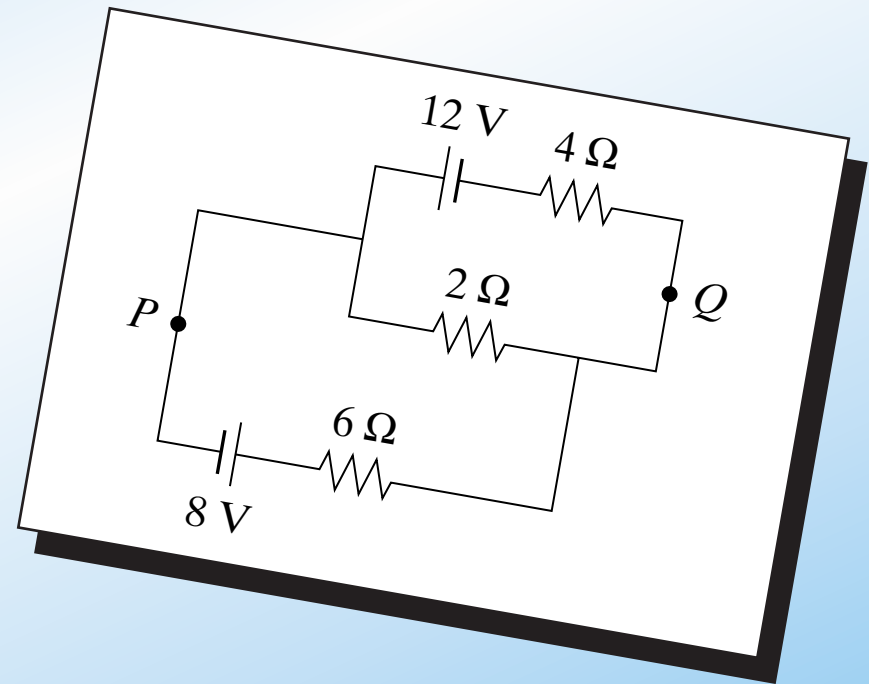

# Why do we have this problem?

## Conventional problems reinforce bad study habits

Calculate:

- (a) the current in the  $2\text{-}\Omega$  resistor, and
- (b) the potential difference between points  $P$  and  $Q$

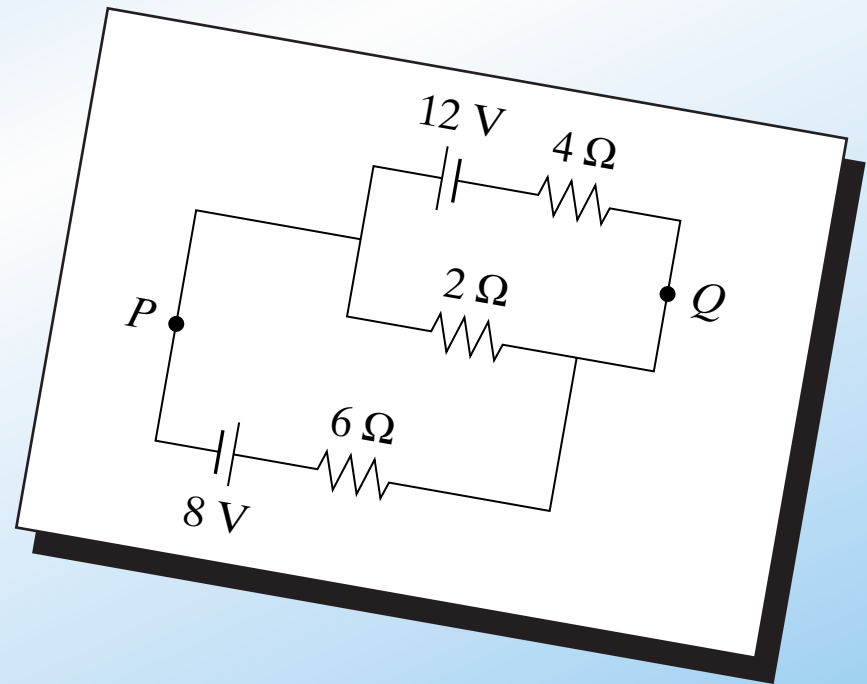

*Why do we have this problem?*

**Are basic principles understood?**

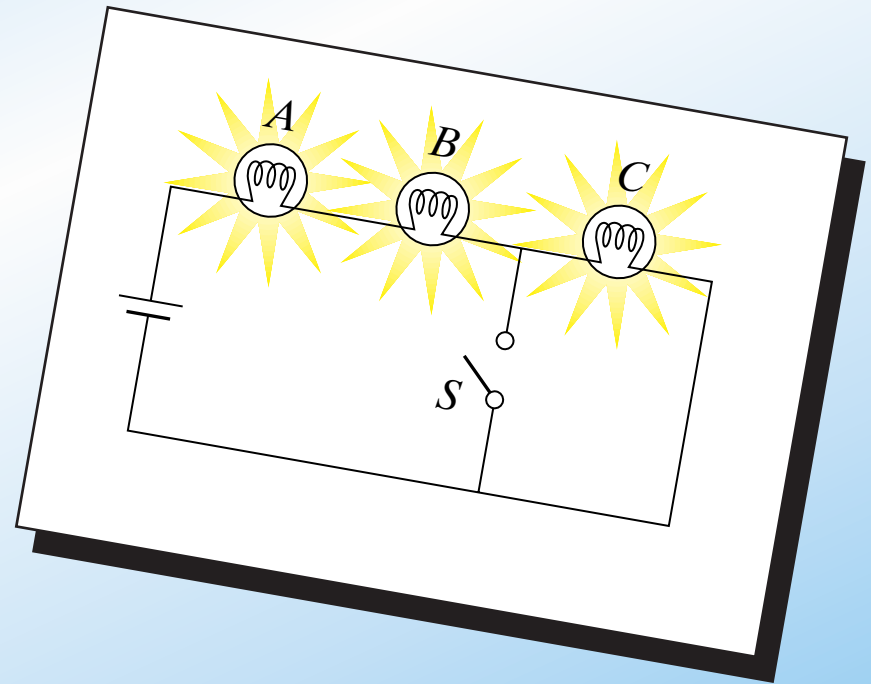

# Why do we have this problem?

## Are basic principles understood?

When  $S$  is closed, what happens to the:

- (a) intensities of  $A$  and  $B$ ?
- (b) intensity of  $C$ ?
- (c) current through battery?
- (d) voltage drop across  $A$ ,  $B$ , and  $C$ ?
- (e) total power dissipated?

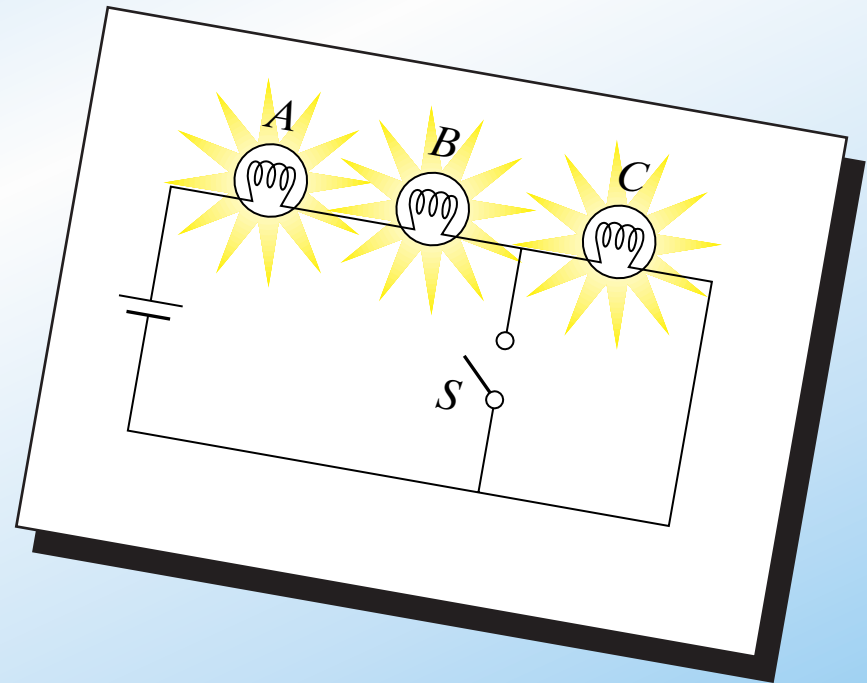

# Why do we have this problem?

conventional

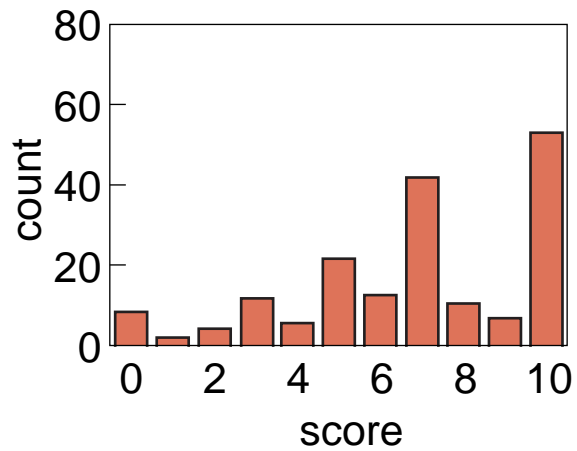

conceptual

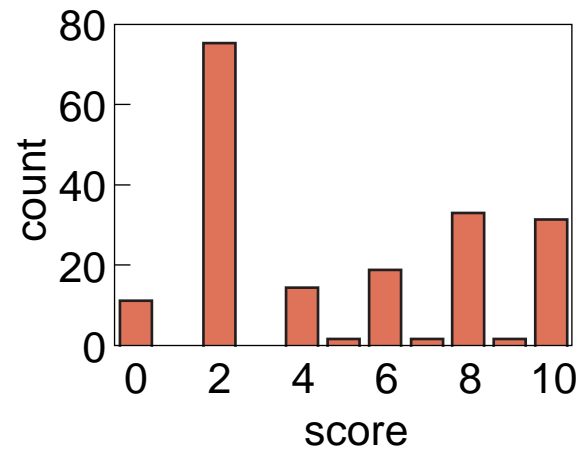

# Why do we have this problem?

## conventional

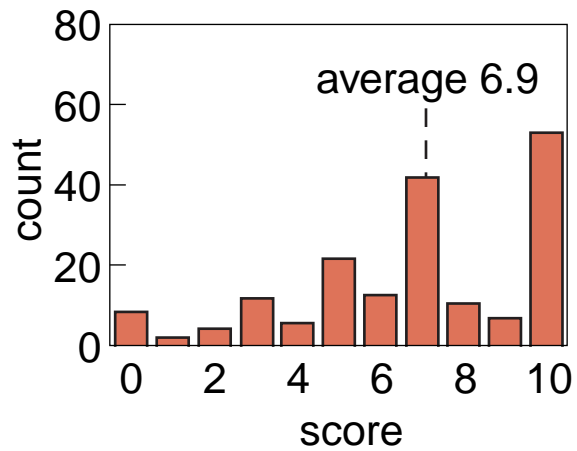

## conceptual

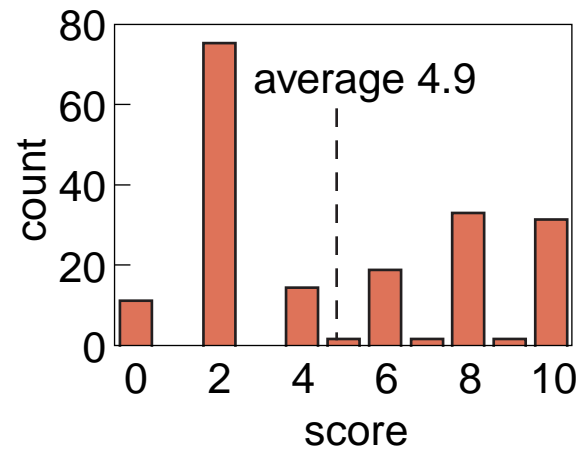



# Why do we have this problem?

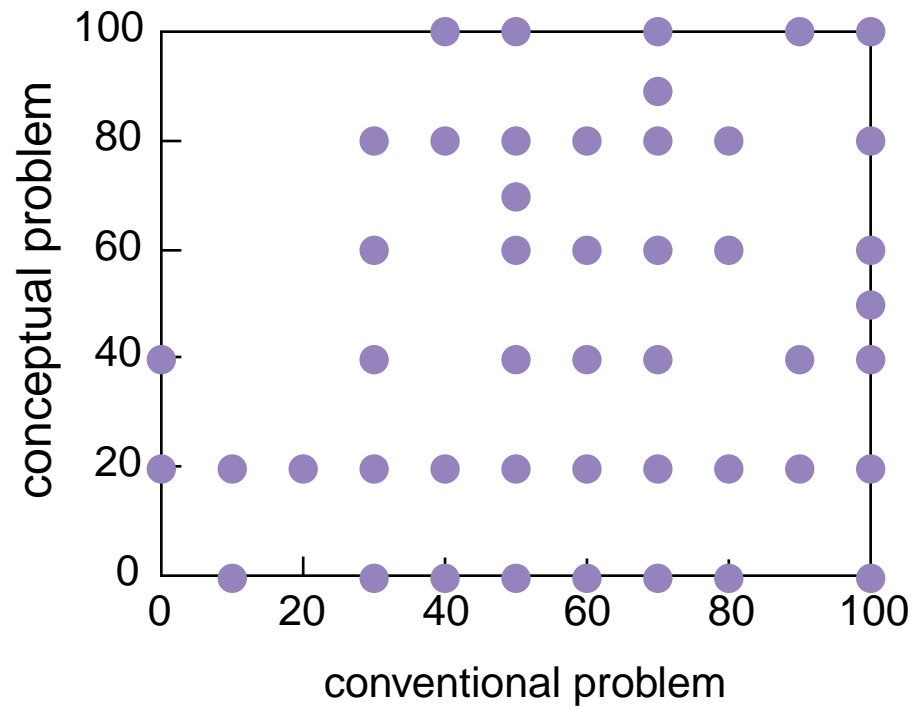

# Why do we have this problem?

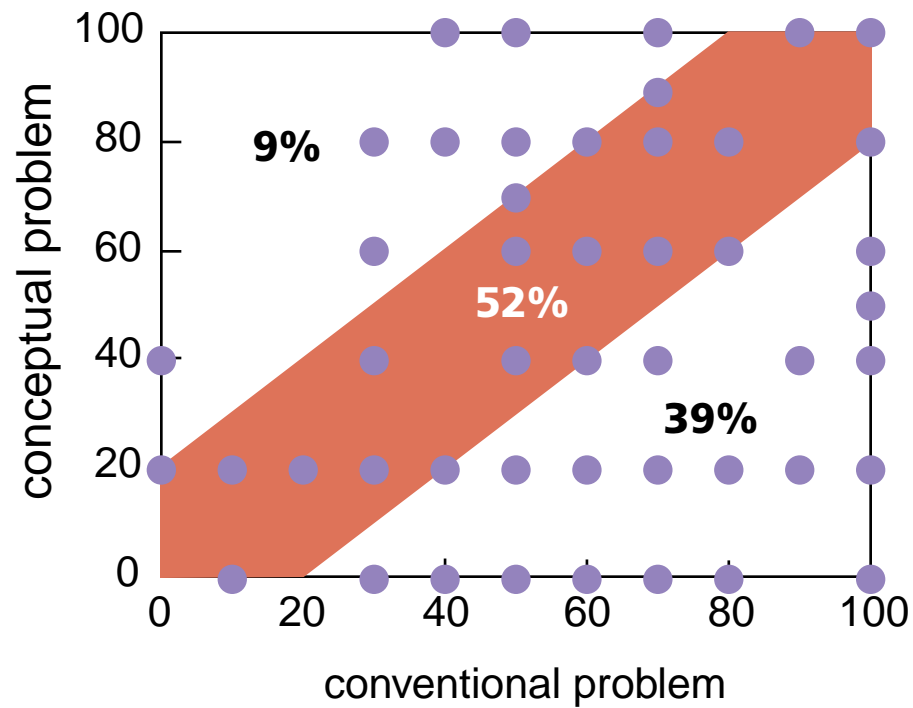

A wide-angle photograph of a large lecture hall. The room is filled with students seated at desks, facing a stage. On the stage, a lecturer is standing at a podium, and a large projection screen displays text. The text on the screen is partially legible and appears to be a list or a set of instructions. The room has a curved wall and a high ceiling. The lighting is focused on the stage area.

So what should we do?

# *Peer Instruction*

**Help students take more responsibility for learning!**

# *Peer Instruction*

## **Main features:**

- ▶ **Pre-class reading**
- ▶ **In class: depth, not coverage**
- ▶ **ConcepTests**

## *ConcepTest*

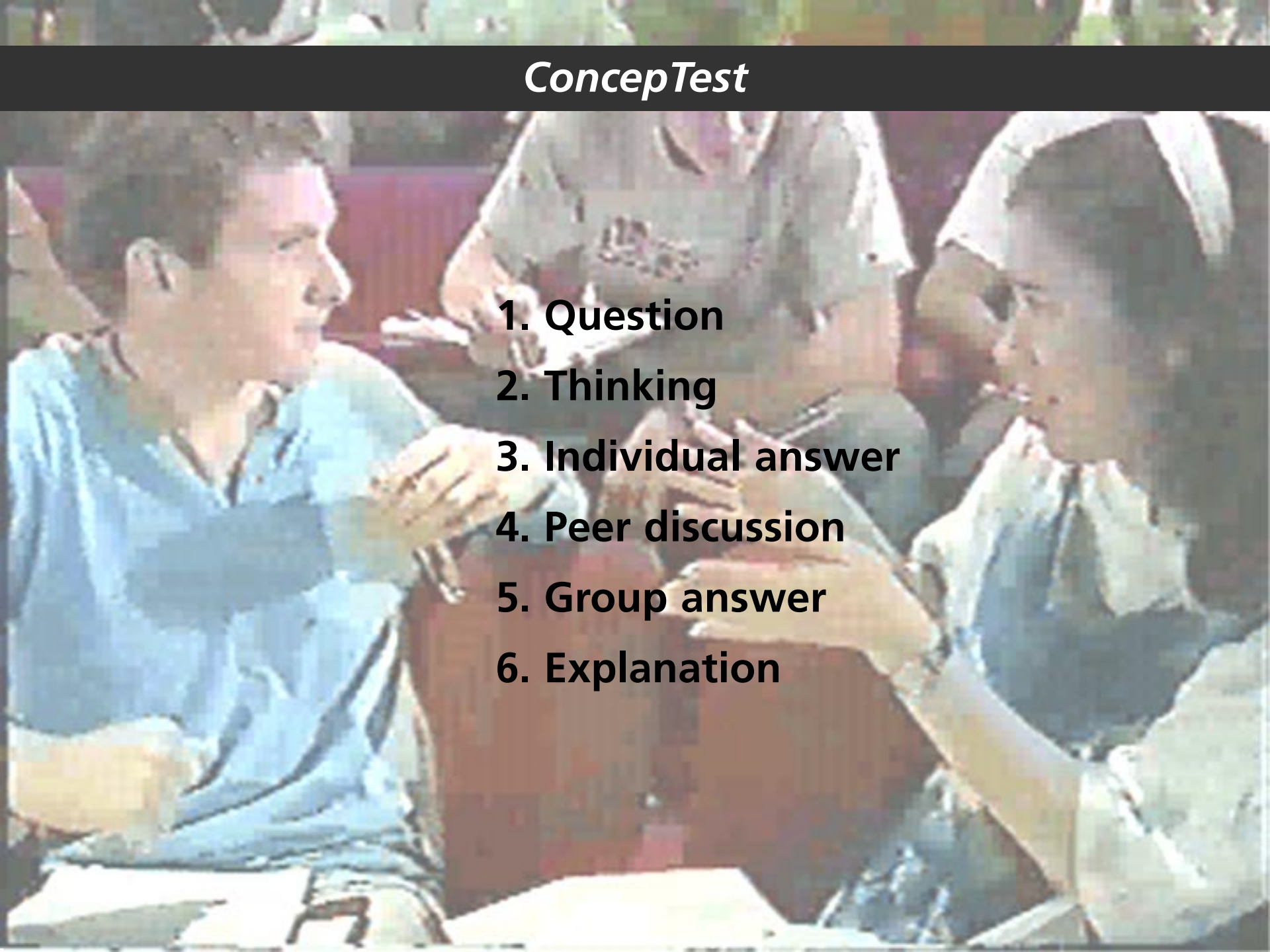
1. Question
  2. Thinking
  3. Individual answer
  4. Peer discussion
  5. Group answer
  6. Explanation
- 
- A photograph of three students in a classroom setting. A male student in a blue shirt is on the left, gesturing with his hands while speaking. A female student in a white headscarf is on the right, listening intently. A third student is partially visible in the background. They appear to be engaged in a group discussion or peer review activity.

*Is it any good?*

*Is it any good?*

▶ **Results**



# *Is it any good?*

- ▶ **Results**
- ▶ **Student Reactions**

# Results

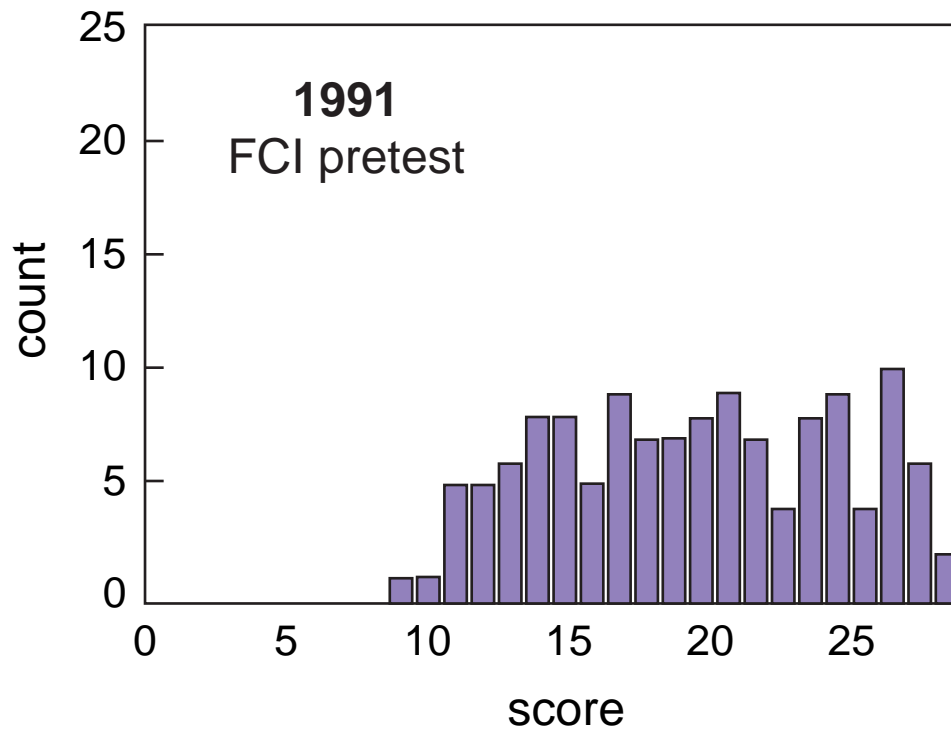

# Results

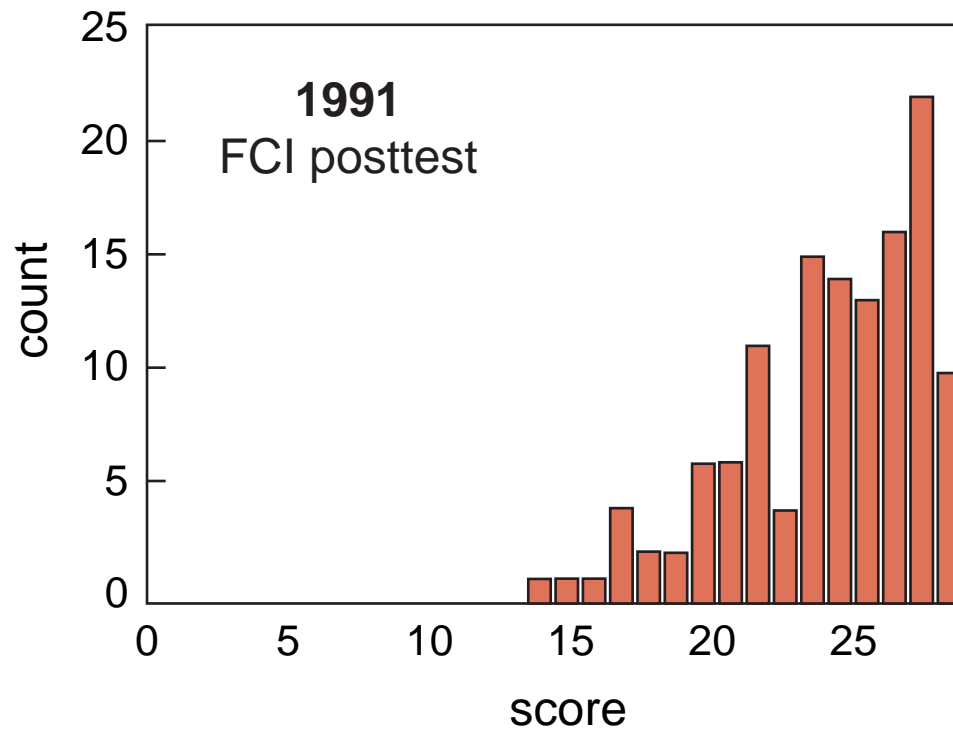

# Results

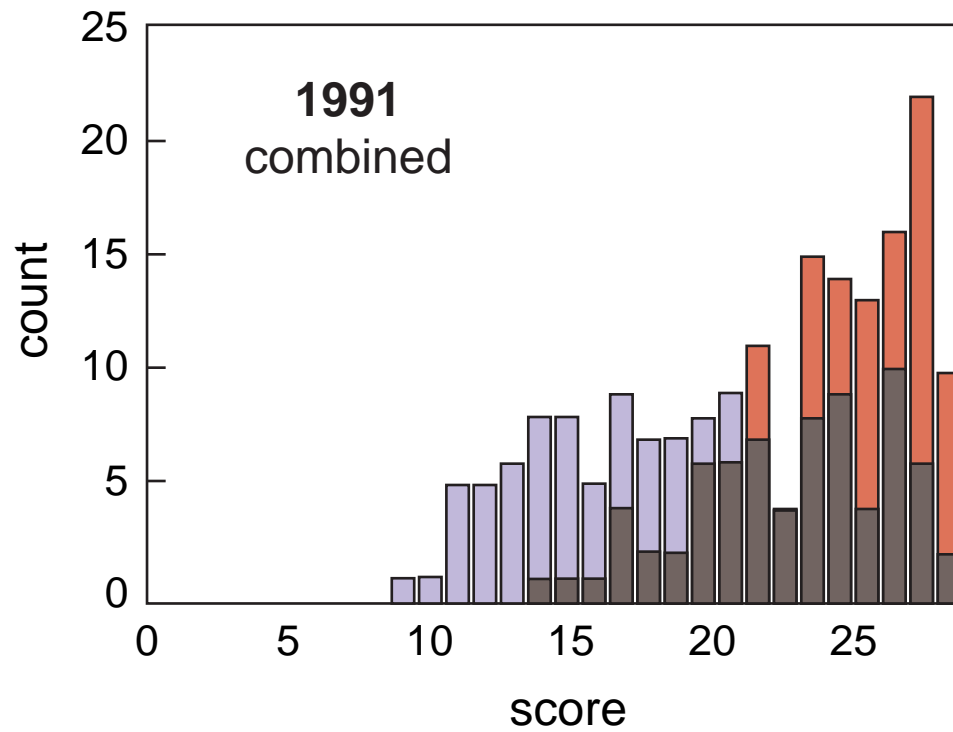

# Results

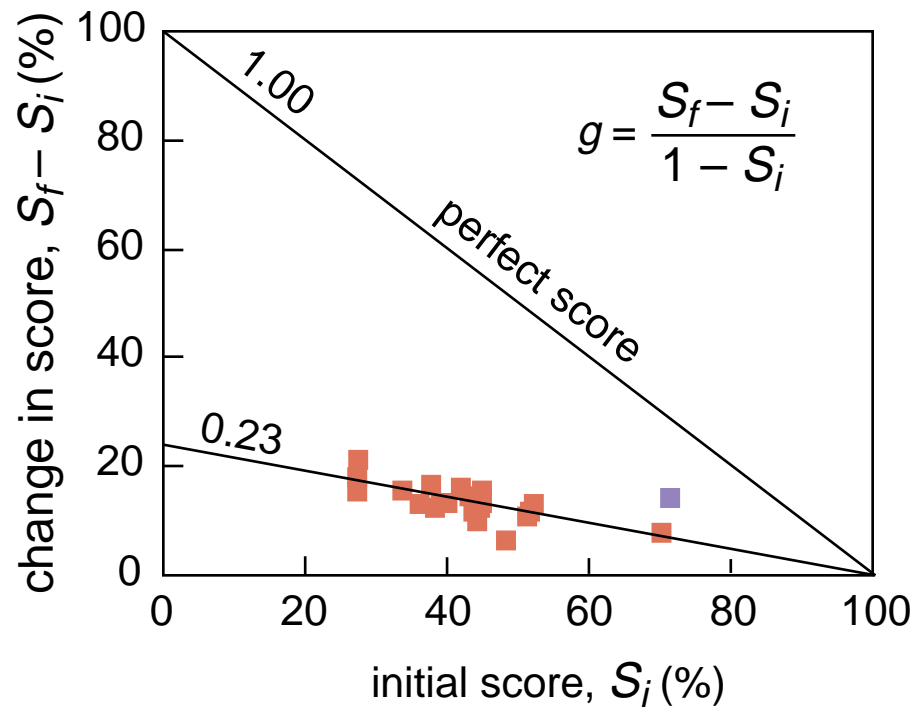

# Results

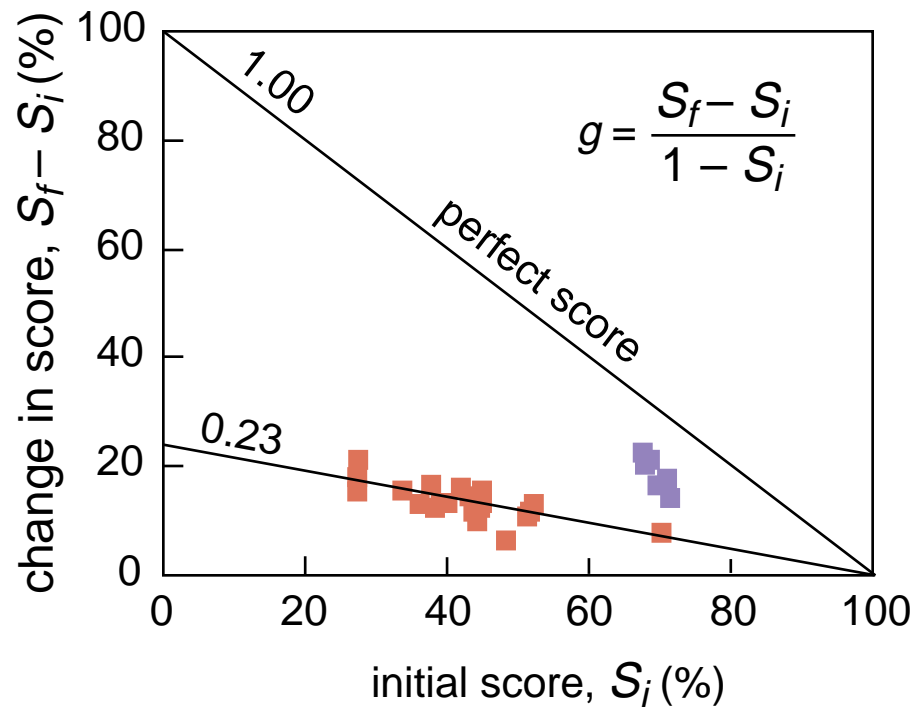

# Results

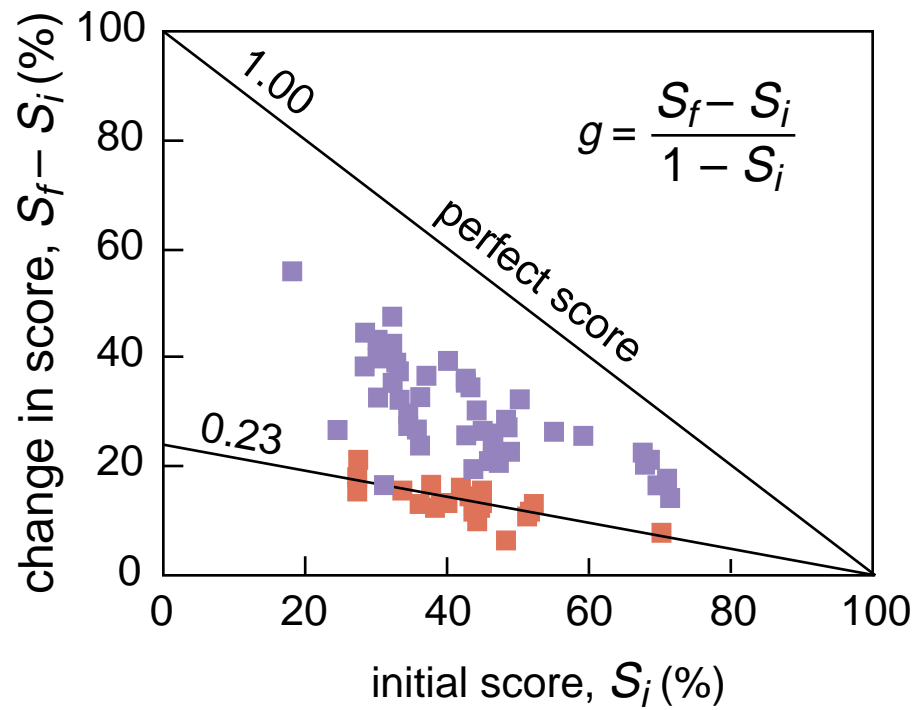

# Results

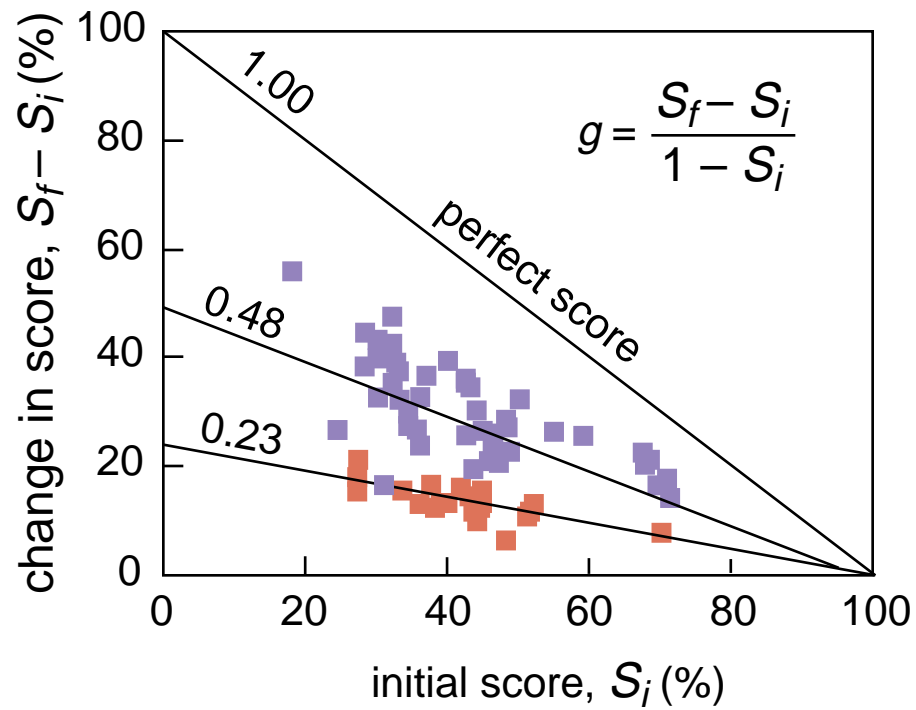



# *Results*

**What about problem solving...?**

# Results

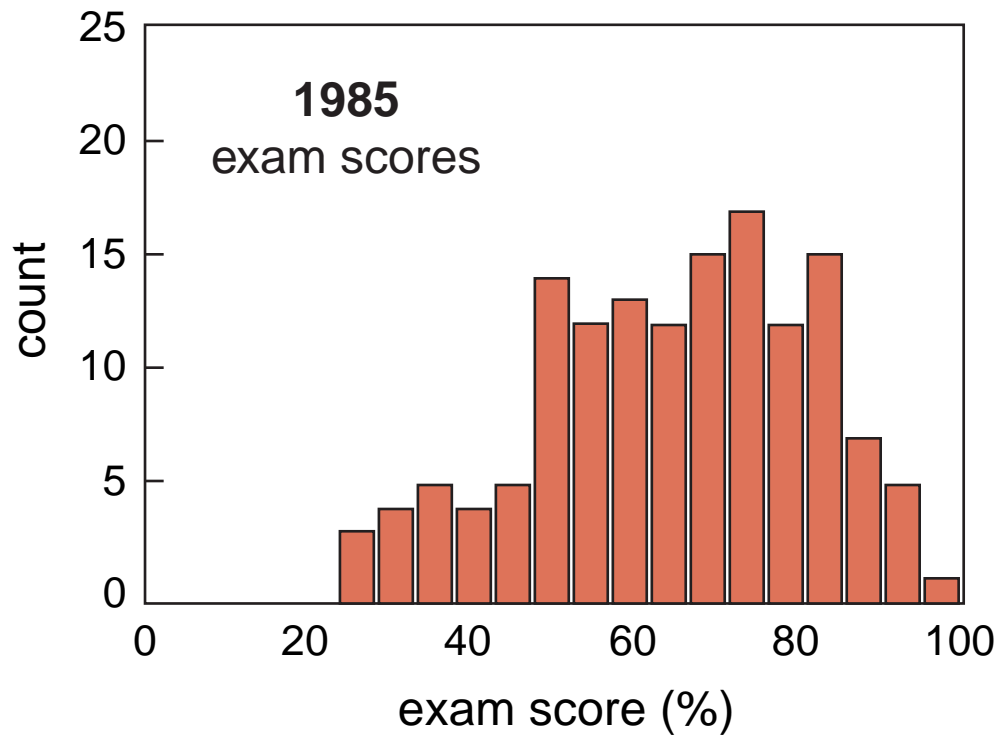

# Results

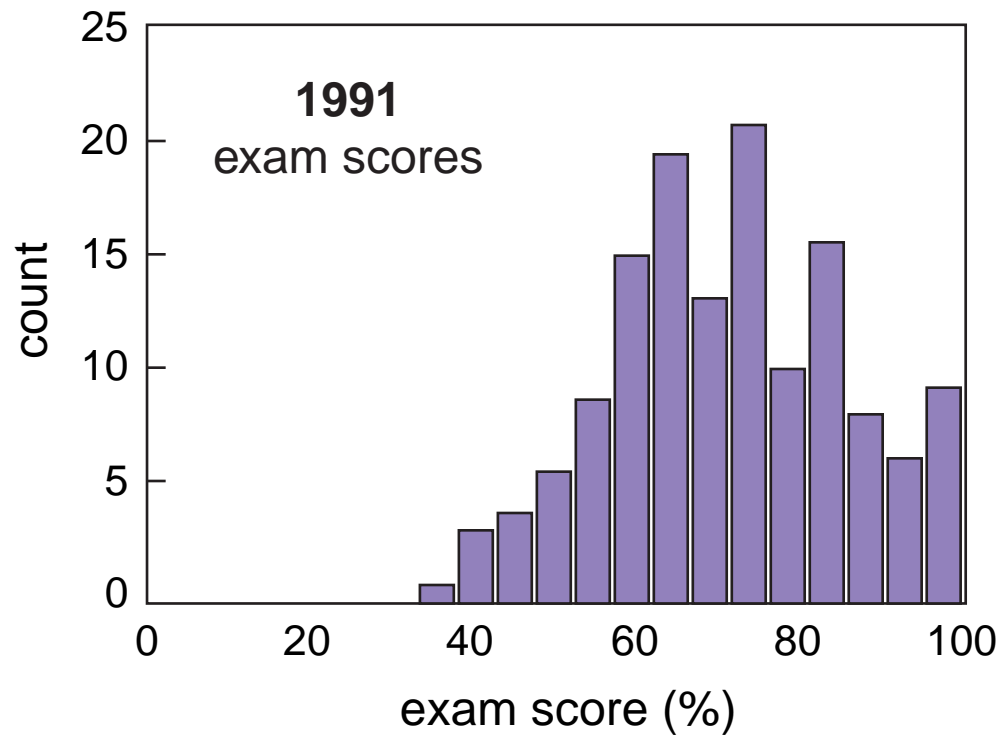

# Results

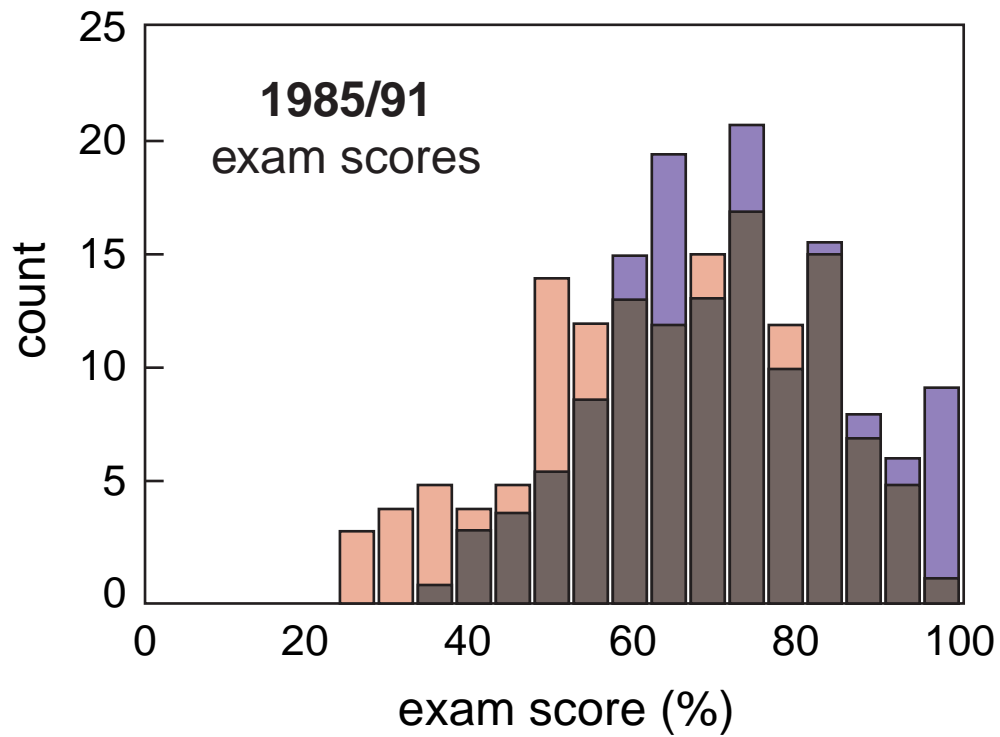

# *Results*

**So better understanding leads to better  
problem solving!**

# *Results*

**So better understanding leads to better problem solving!**

**(but “good” problem solving doesn’t always indicate understanding!)**



# *Conclusion*

**Let's not forget the base  
of the pyramid!**

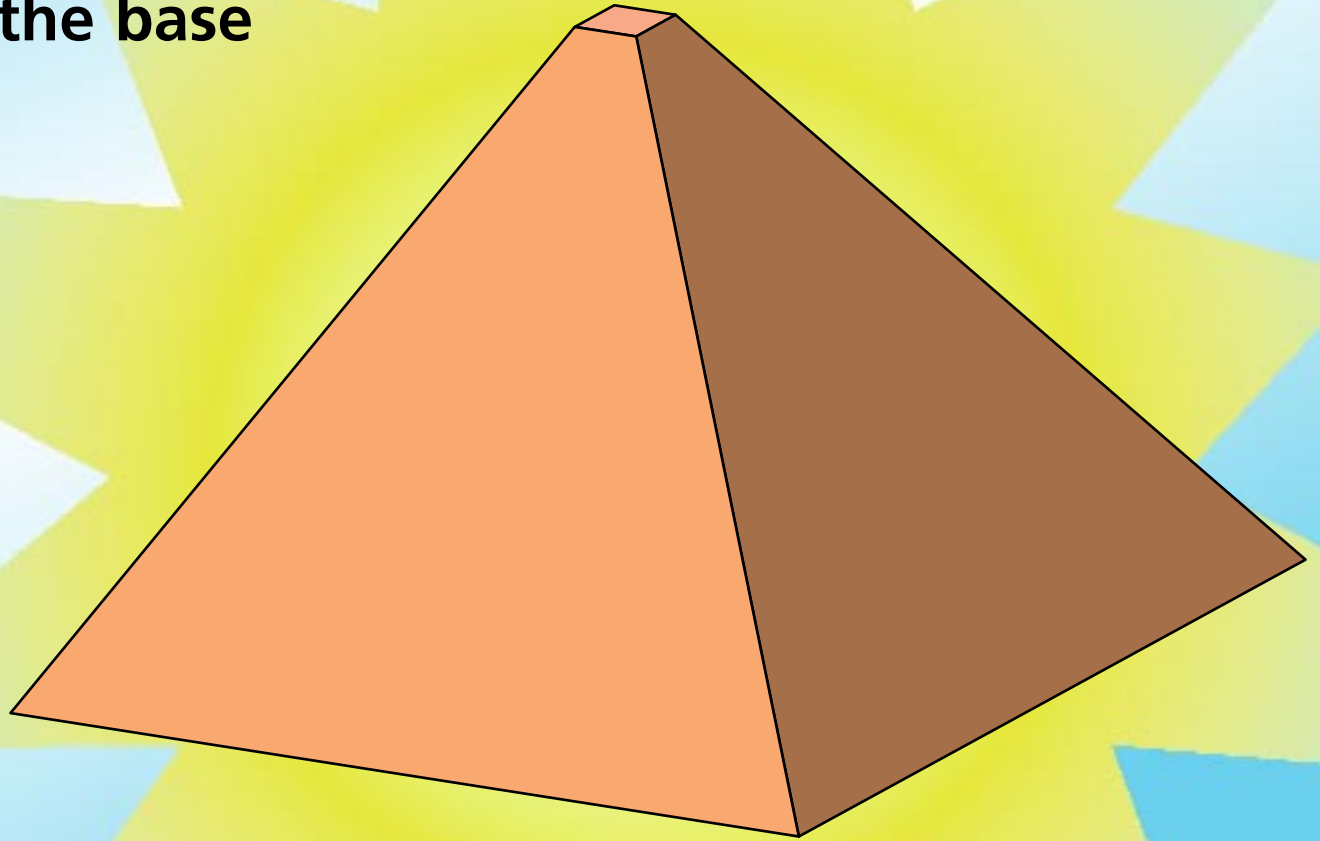



# *Conclusion*

**Let's give them something  
of value!**

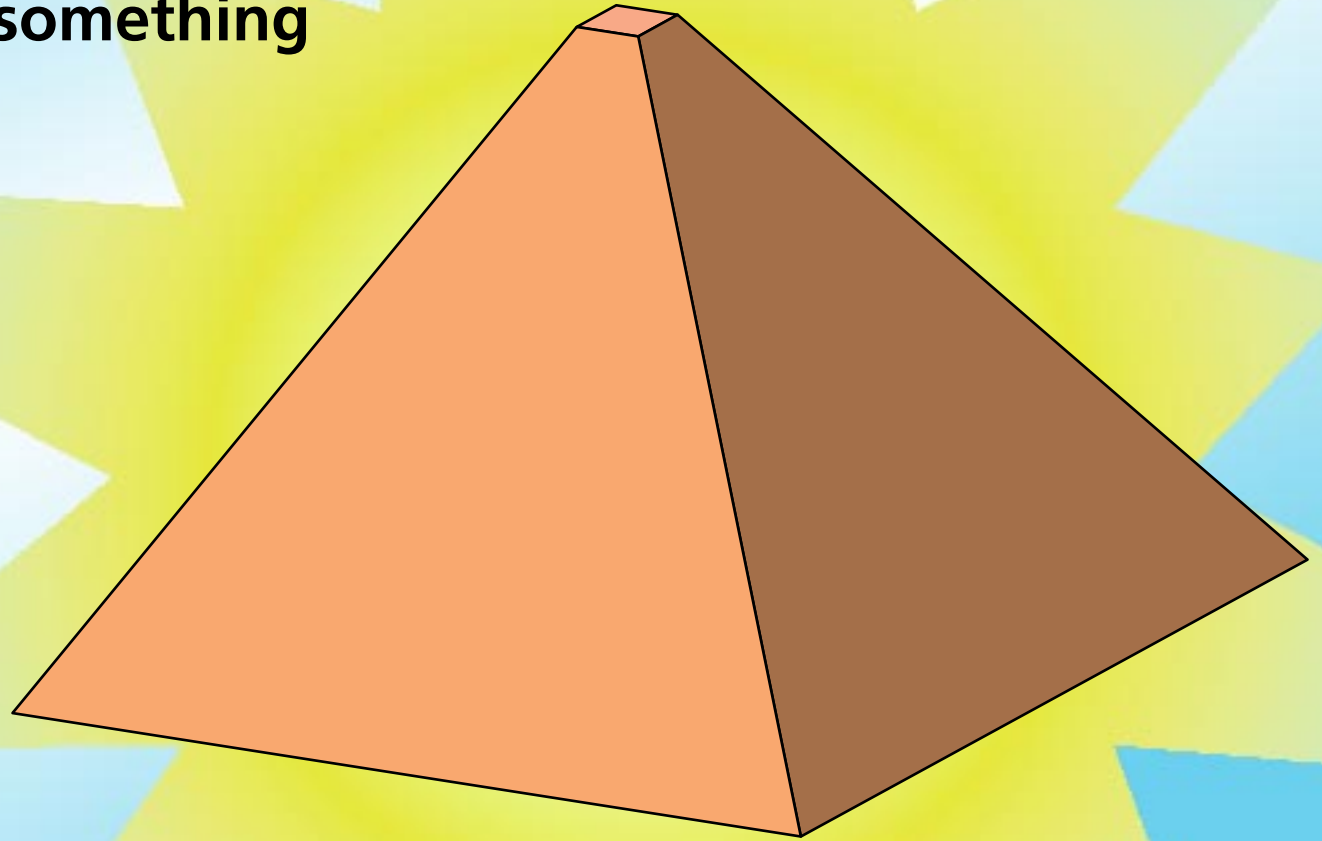

# *Conclusion*

## **Challenges:**

- ▶ **internal skepticism**
- ▶ **growing pains**
- ▶ **limited circle of influence**

# *Conclusion*

## Rewards:

- ▶ engagement
- ▶ improved understanding
- ▶ class is fun!

## **Funding**

**National Science Foundation**

**For a copy of this talk and  
additional information:**

**<http://mazur-www.harvard.edu>**