

ACTIVE LEARNING AND INTERACTIVE LECTURES

**Eric Mazur
Harvard University**

**AAPT New Faculty Meeting
10 November 2000**



Outline

- ▶ **Now: we have a problem**

Outline

- ▶ **Now: we have a problem**
- ▶ **After break: from theory to practice**

We have a problem

**380,000 students take
introductory physics
each year...**

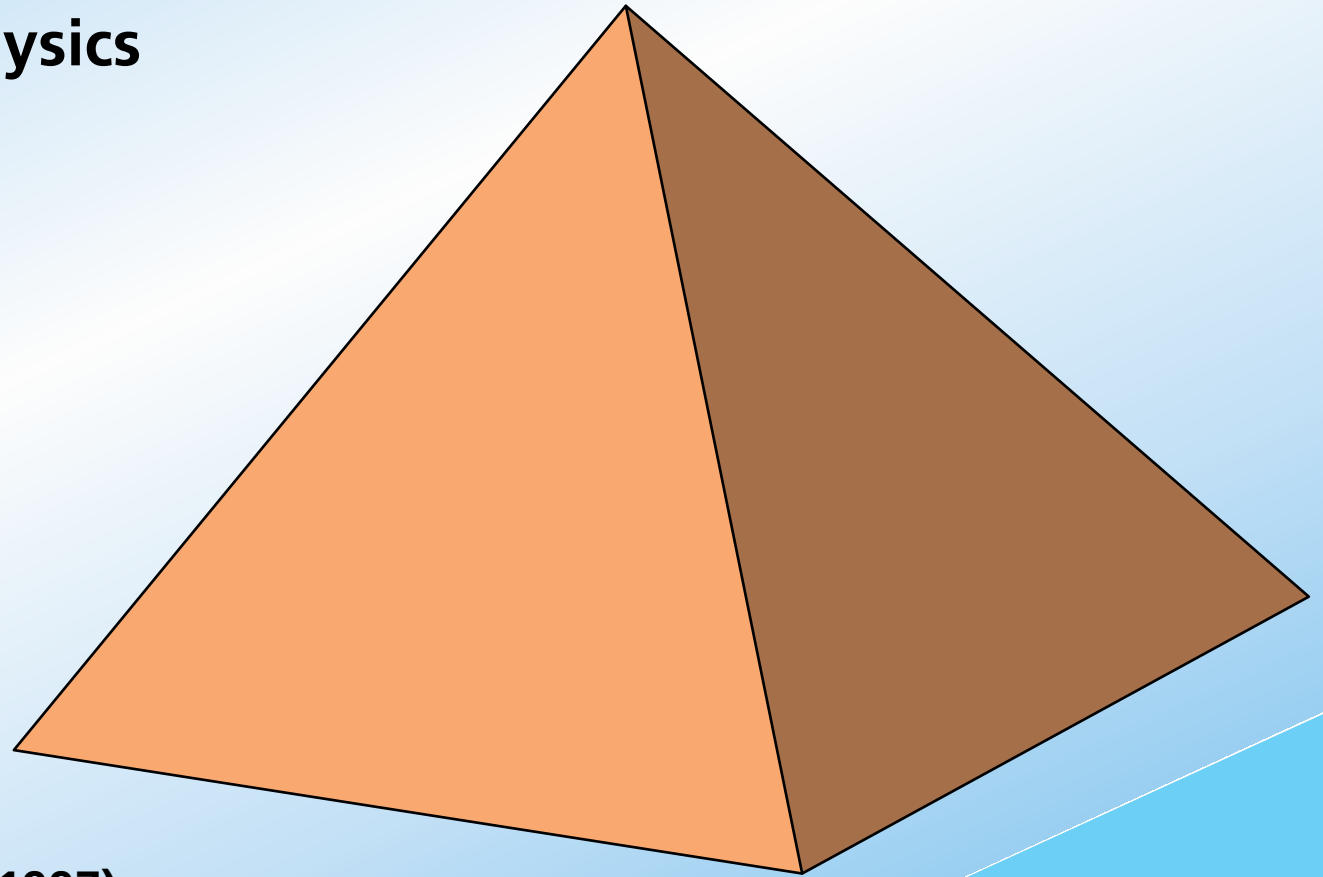

AIP Report R-151.33 (1997)

We have a problem

**about 1% of these get
a bachelor's degree
in physics**

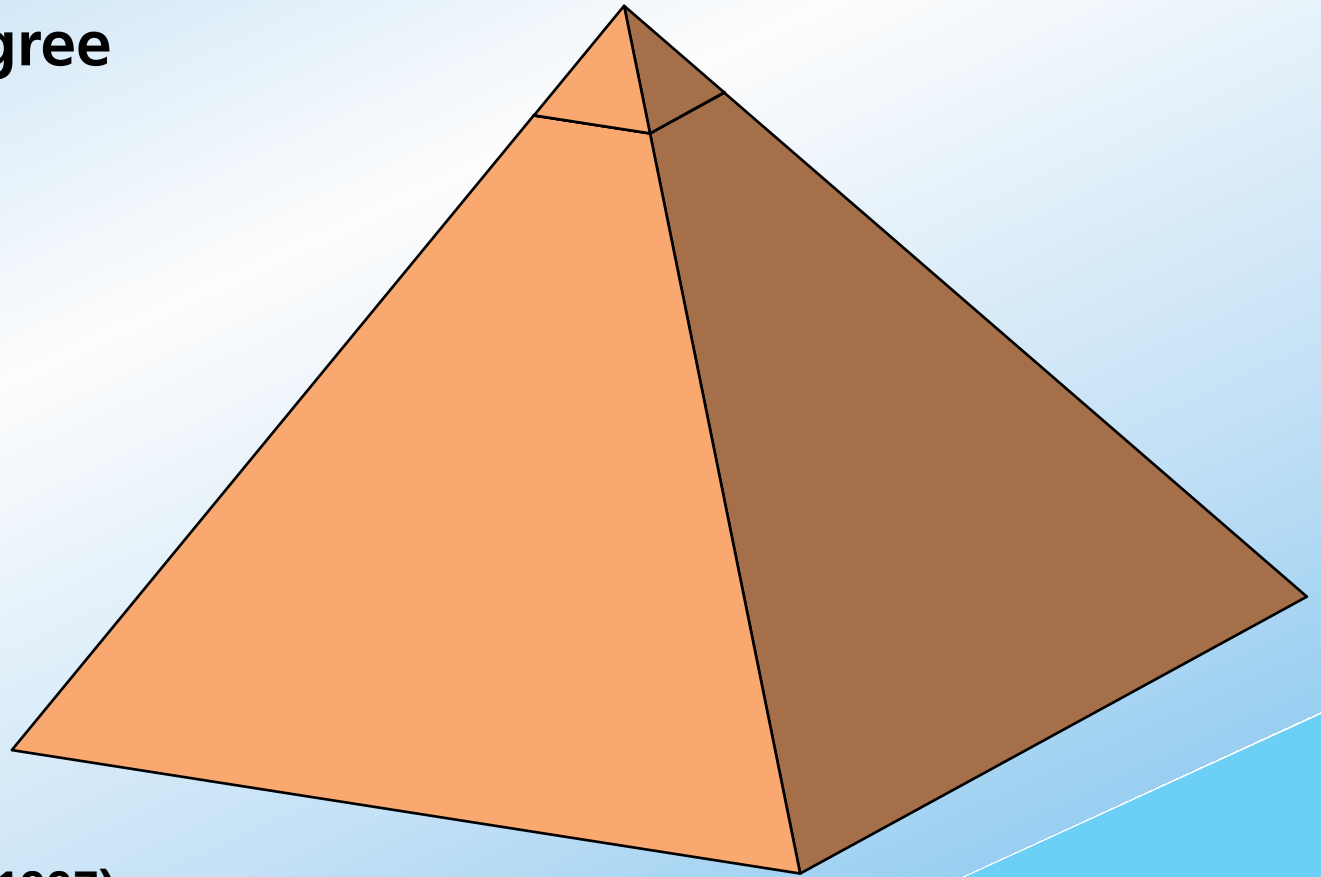

We have a problem

**Of the 4,300 students with
a bachelor's degree
in physics...**

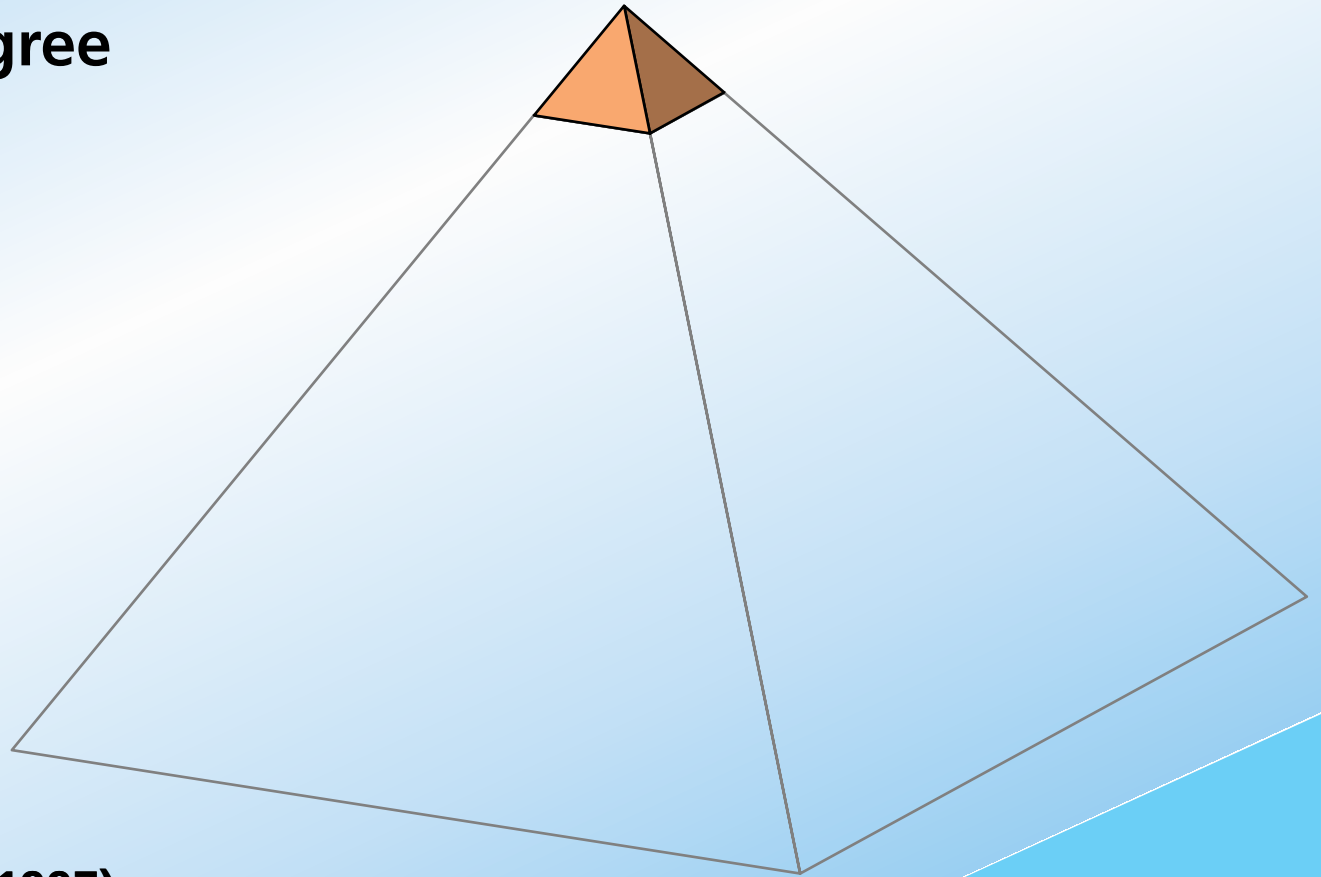

We have a problem

**about 35% go on to get a
Ph.D. in physics...**

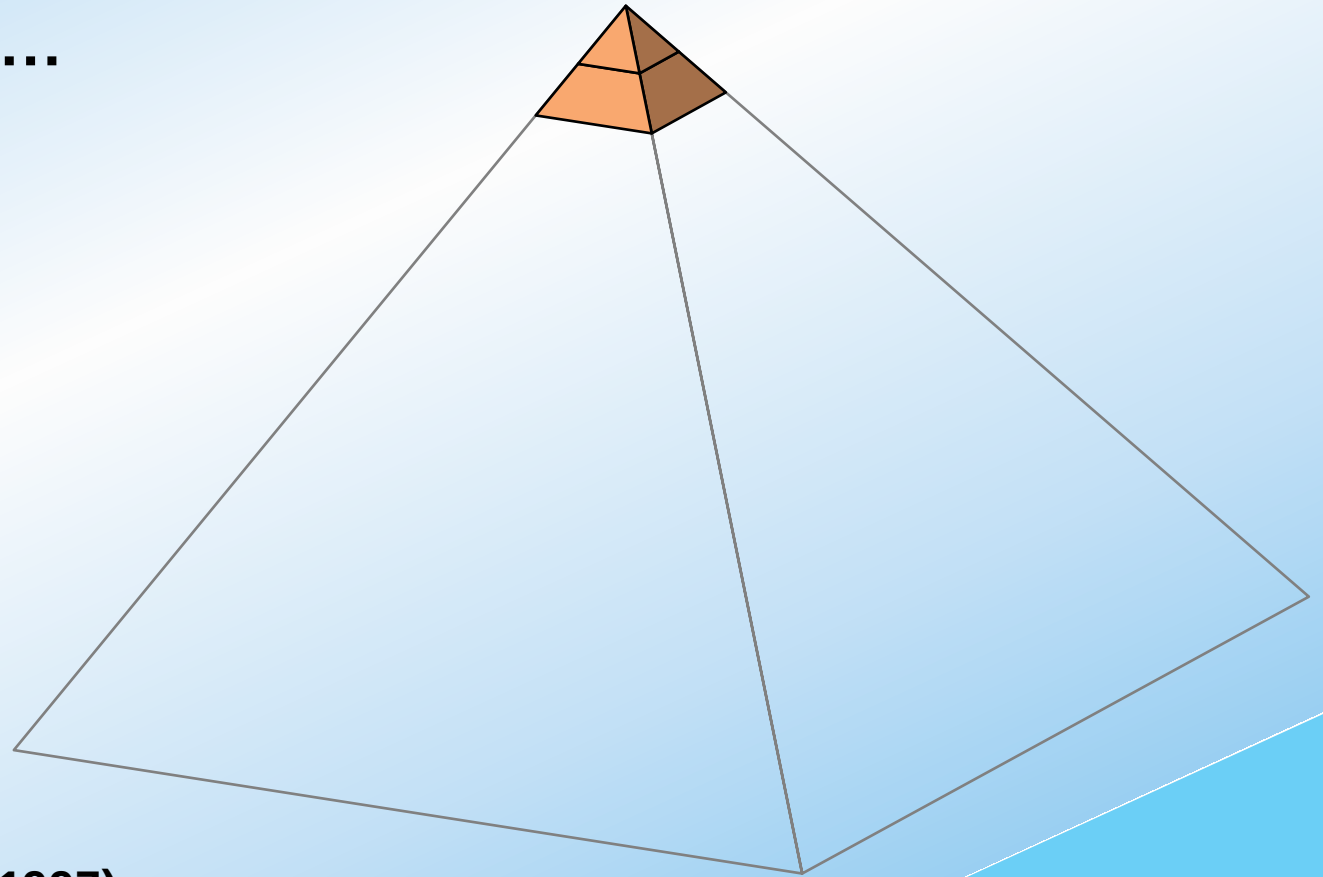

AIP Report R-151.33 (1997)

We have a problem

**That's one out of every
260 students in our
introductory
courses!**

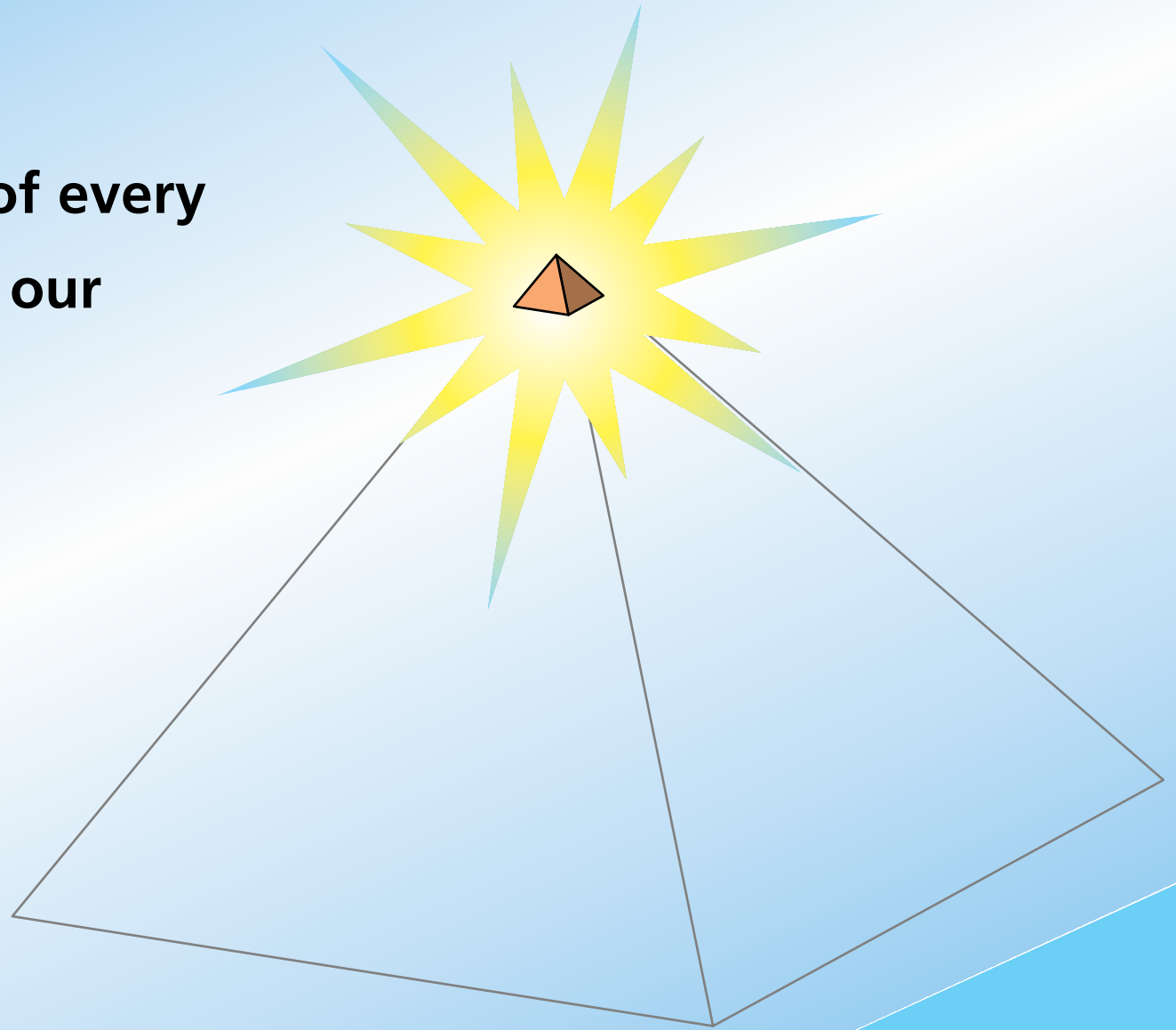

We have a problem

**What about the
other 259...?**

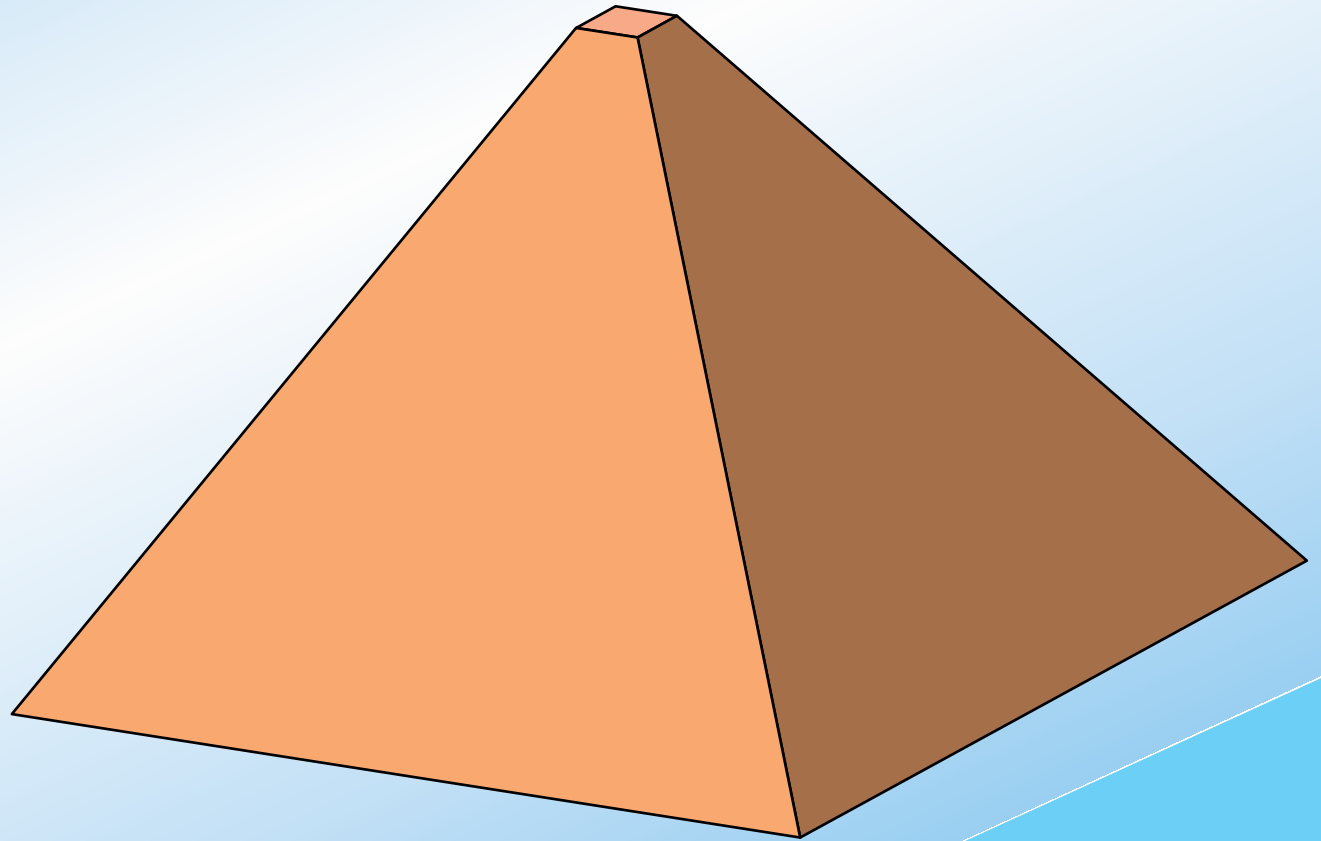

We have a problem

**What do we know
about these
students?**

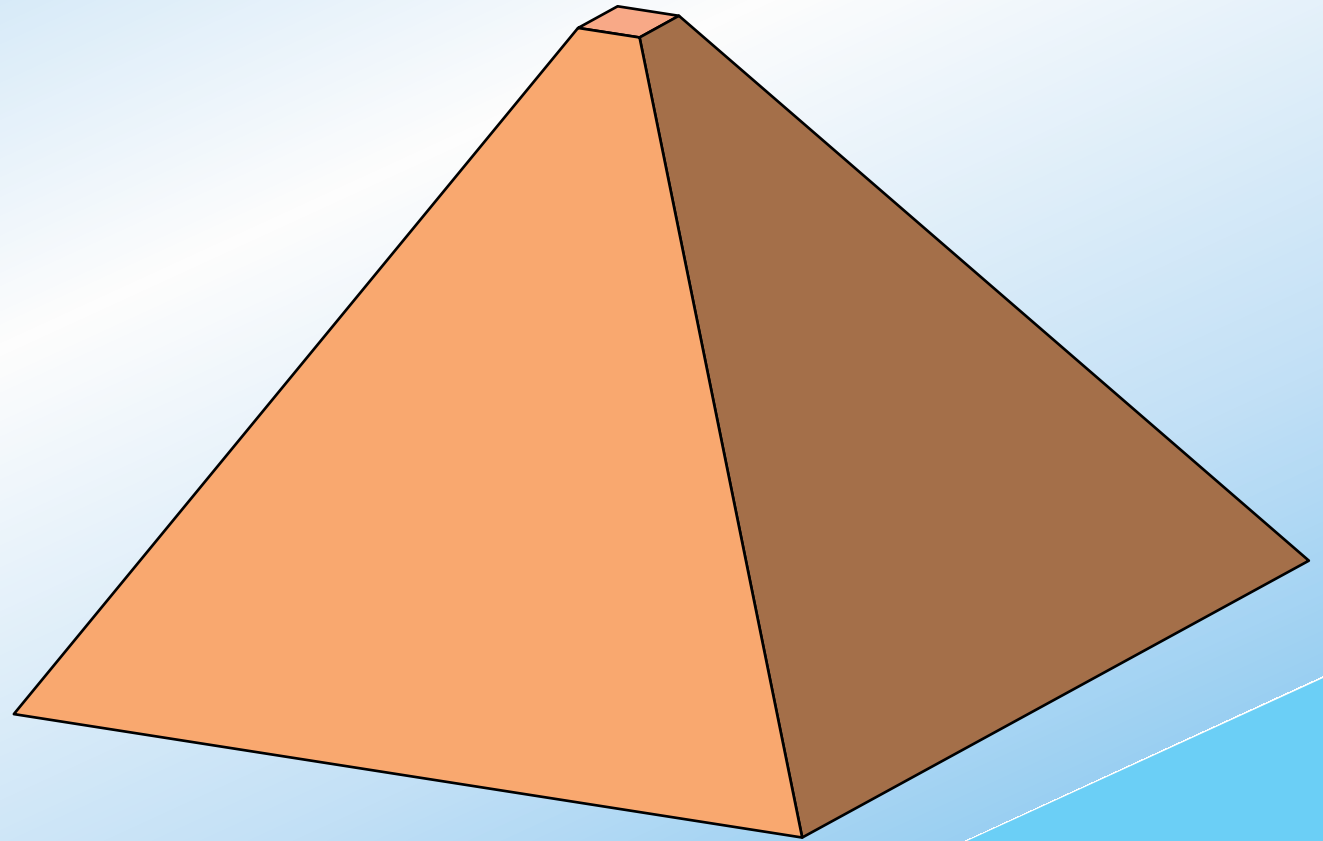

We have a problem

Some disturbing symptoms:

- ▶ **frustration**
- ▶ **lack of understanding**
- ▶ **lack of basic knowledge**

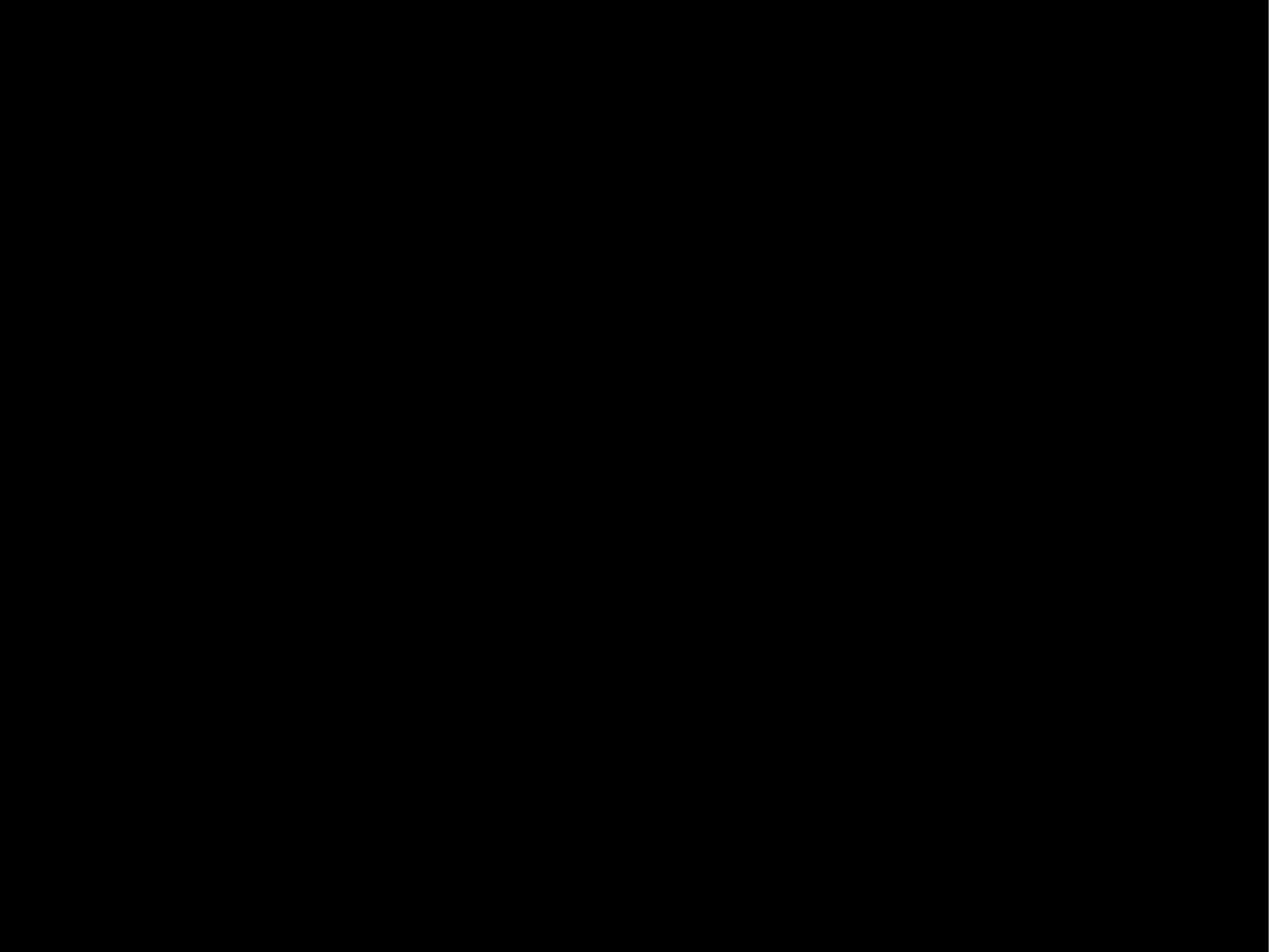

We have a problem

They know the jargon:

- ▶ **circular motion**
- ▶ **barometric pressure**
- ▶ **light radius**
- ▶ **something to the power times ten to the something**

We have a problem

They are aware of their lack of knowledge

- ▶ **I graduated from college but I didn't study *astronomy***
- ▶ **It's been a while since I've had physics**

We have a problem

They are aware of their lack of knowledge

- ▶ **I graduated from college but I didn't study *astronomy***
- ▶ **It's been a while since I've had physics**

...and they don't care!

We have a problem



We have a problem



**Math suks (math suks),
Math suks (math suks)
I'd like to burn this text book
I hate that stuff so much
Math suks (math suks),
Math suks (math suks)**

**Jimmy Buffett
on *Beach House on the Moon***

We have a problem



I don't know and I don't care

**Another song by Jimmy Buffett
on *Beach House on the Moon***

We have a problem

Should we worry?

We have a problem

We'd better!

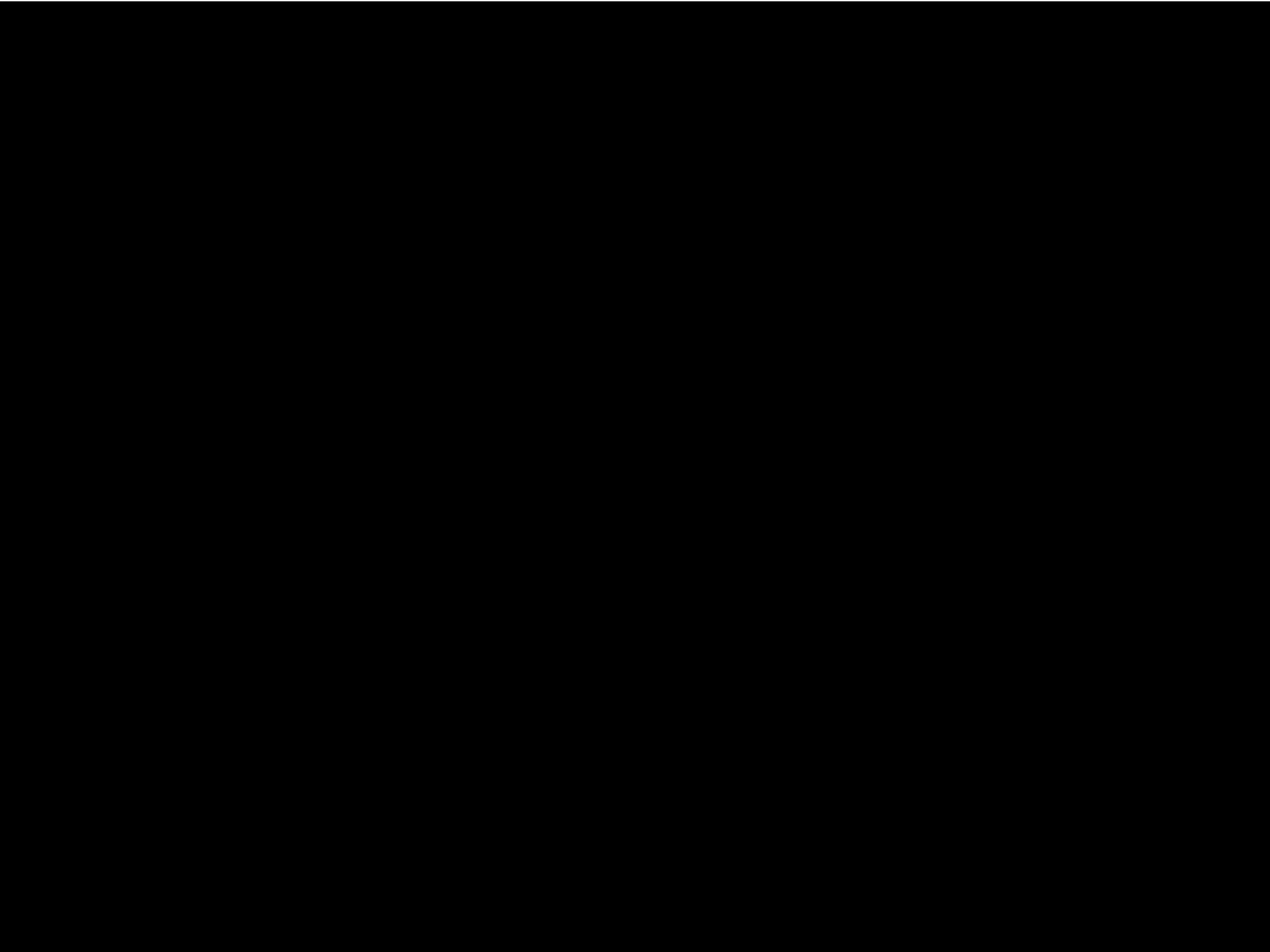

We have a problem

"I took four years of science and four years of math...

**A waste of my time,
a waste of the teacher's time,
and a waste of space...**

**You know,
I took *physics*.**

For *what?*"





Why do we have this problem?

Why do we have this problem?

Lectures focus on transfer of information...

Why do we have this problem?

Conventional problems reinforce bad study habits

Why do we have this problem?

Conventional problems reinforce bad study habits

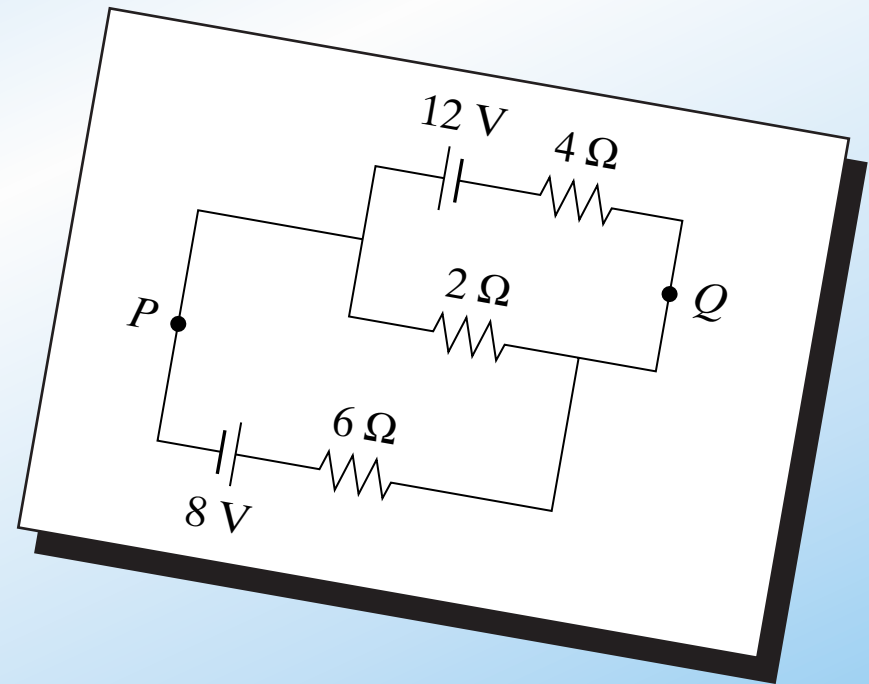

Why do we have this problem?

Conventional problems reinforce bad study habits

Calculate:

- (a) the current in the $2\text{-}\Omega$ resistor, and
- (b) the potential difference between points P and Q

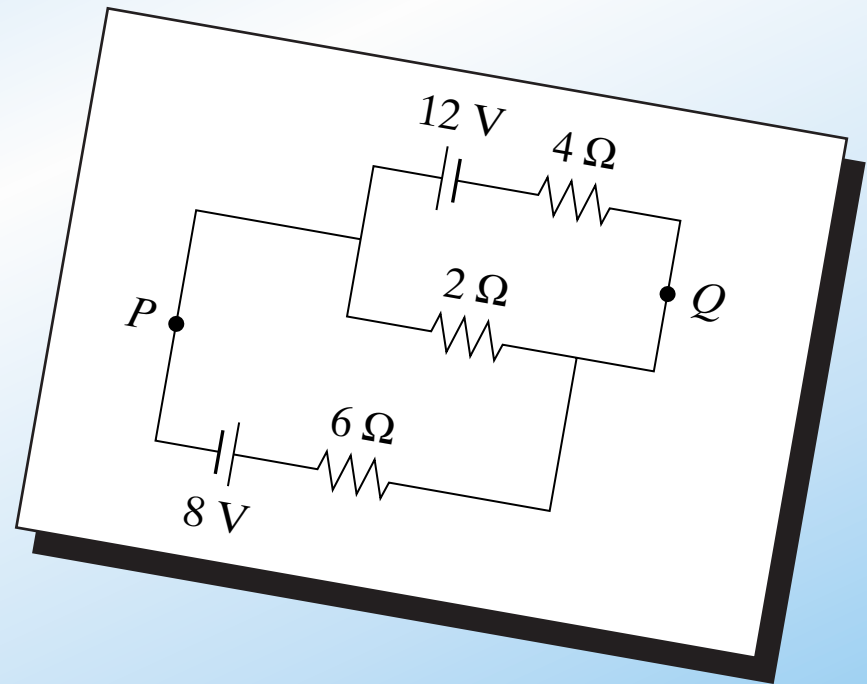

Why do we have this problem?

Are basic principles understood?

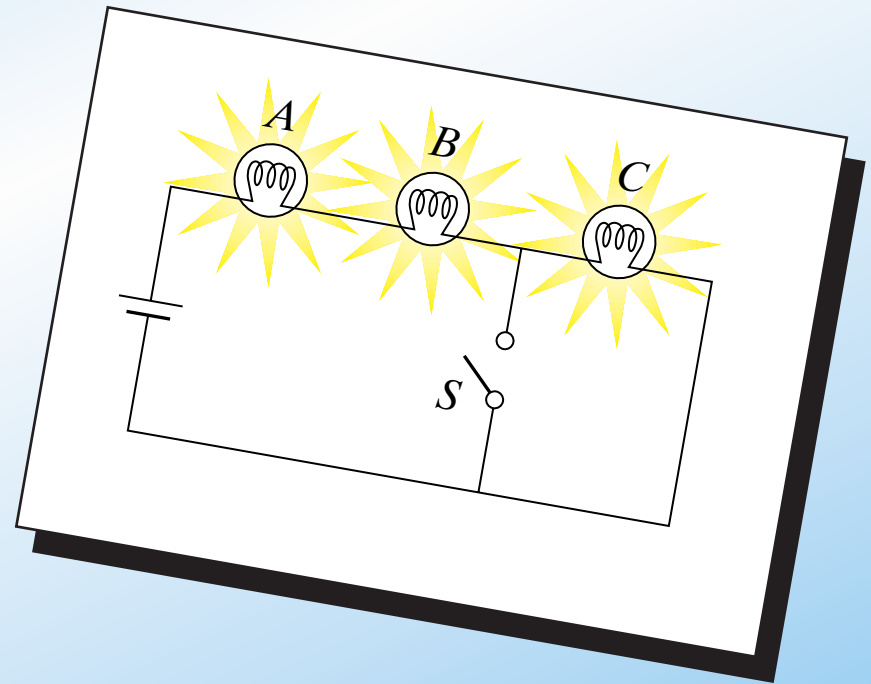

Why do we have this problem?

Are basic principles understood?

When S is closed, what happens to the:

- (a) intensities of A and B ?
- (b) intensity of C ?
- (c) current through battery?
- (d) voltage drop across A , B , and C ?
- (e) total power dissipated?

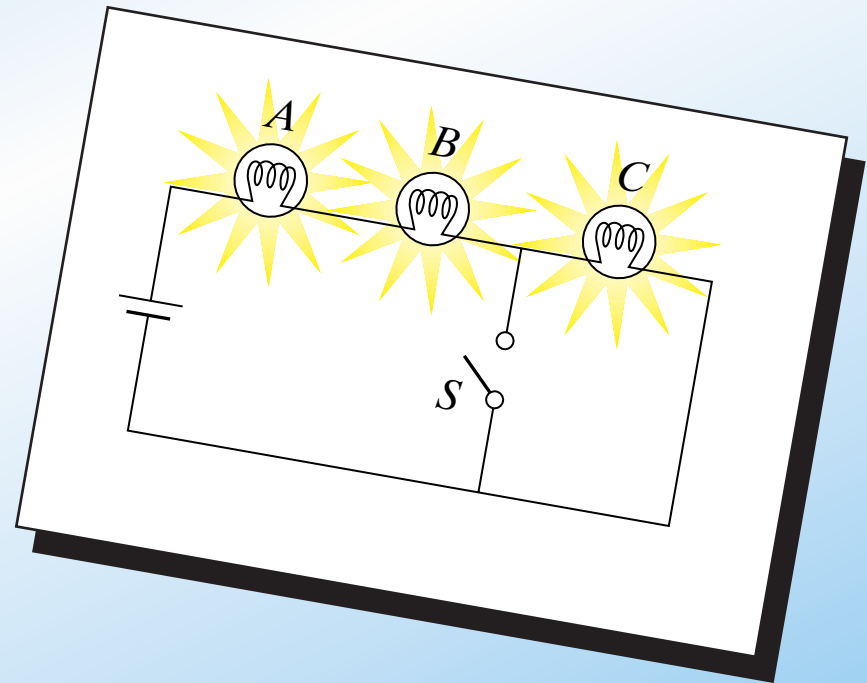

Why do we have this problem?

conventional

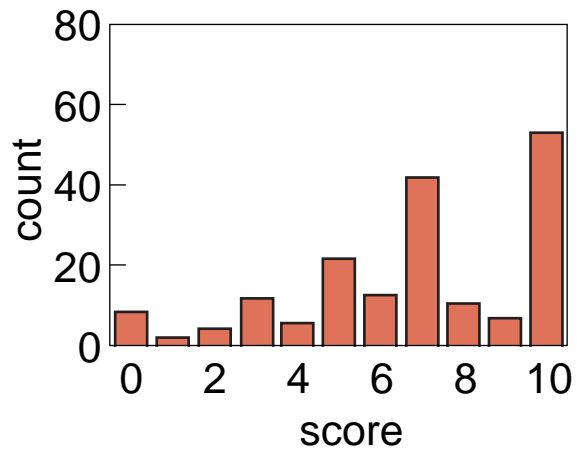

conceptual

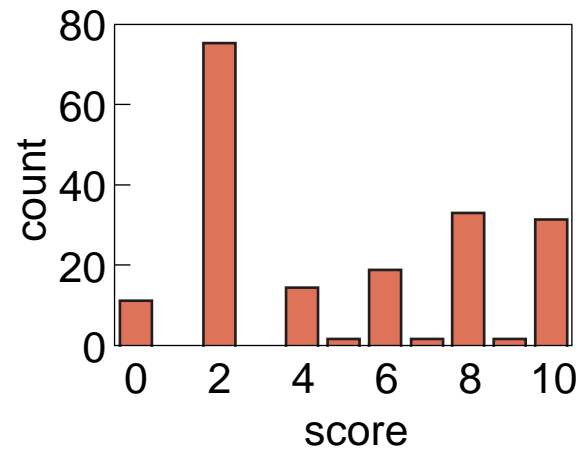

Why do we have this problem?

conventional

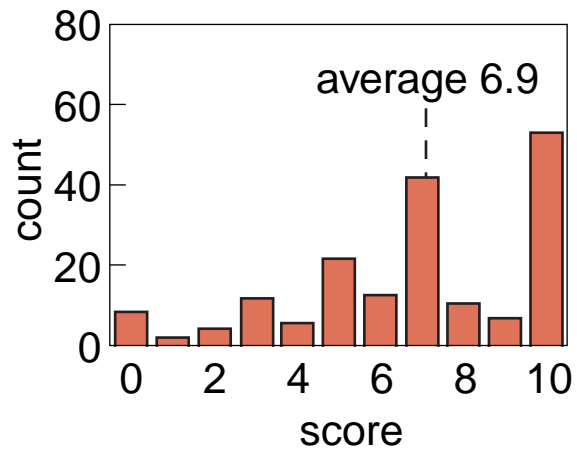

conceptual

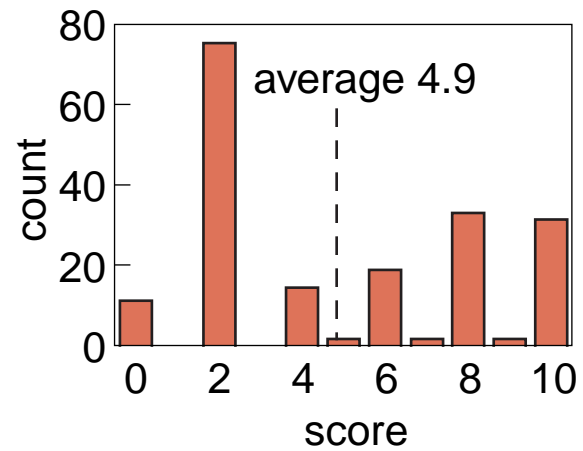

Why do we have this problem?

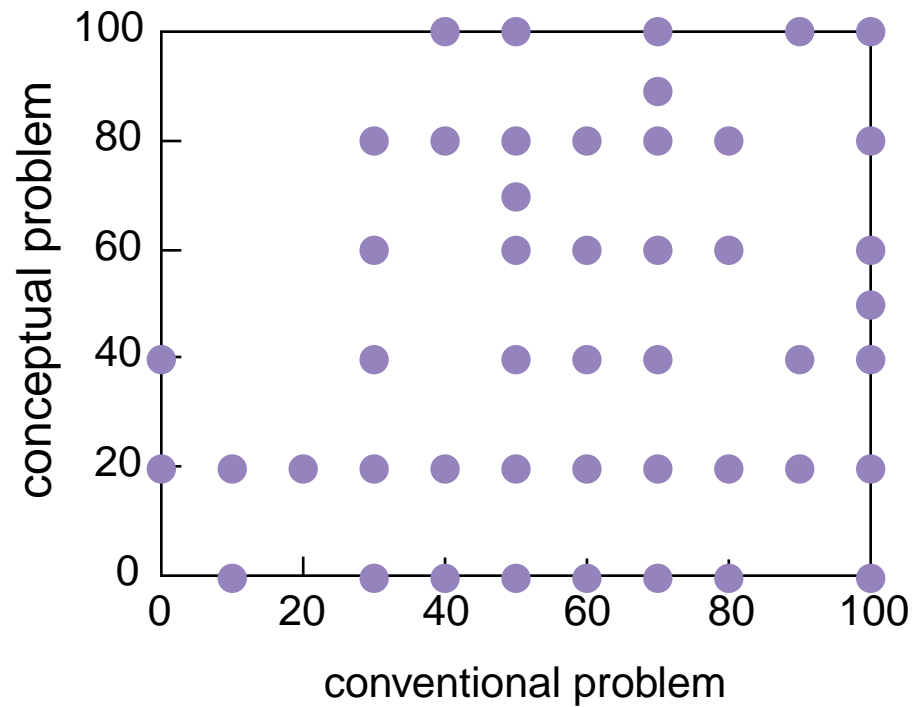

Why do we have this problem?

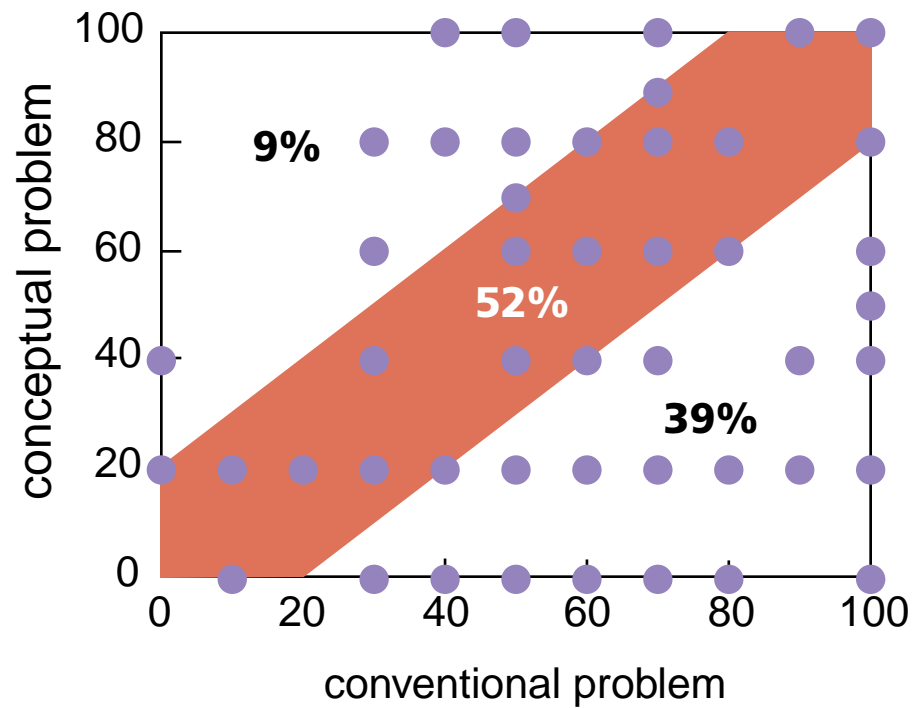



So what should we do?

Peer Instruction

Help students take more responsibility for learning!

Peer Instruction

Main features:

- ▶ **Pre-class reading**
- ▶ **In class: depth, not coverage**
- ▶ **ConcepTests**

ConcepTest

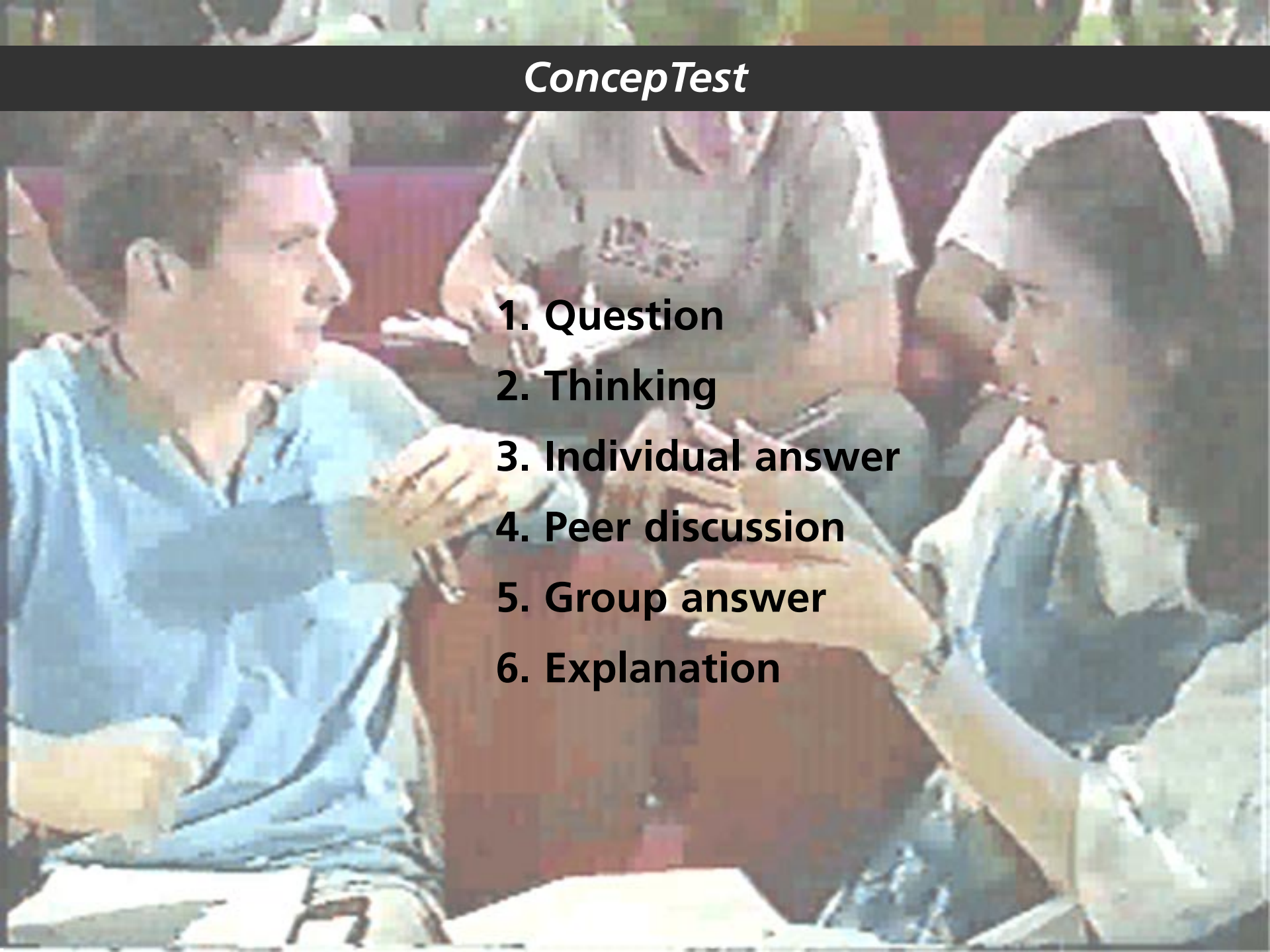
1. Question
 2. Thinking
 3. Individual answer
 4. Peer discussion
 5. Group answer
 6. Explanation
- 
- A photograph of three students in a classroom setting. A male student on the left, wearing a blue shirt, is gesturing with his hands while speaking. A female student in the center, wearing a grey shirt, is looking at him. A female student on the right, wearing a white headscarf and a blue and white patterned shirt, is also gesturing with her hands as if participating in the discussion. They are all looking towards each other, engaged in a collaborative learning activity.

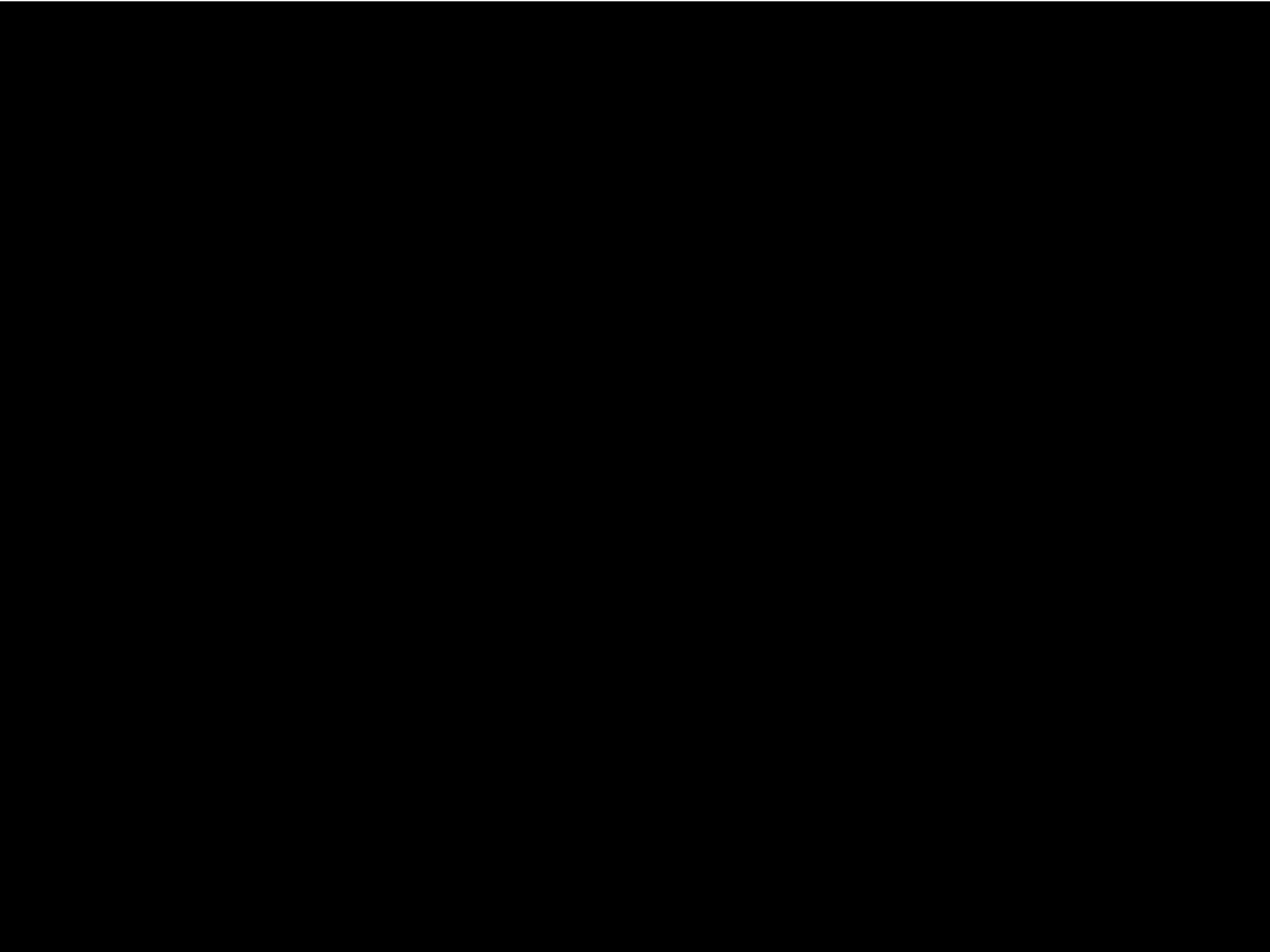

Results

What about problem solving...?

Results

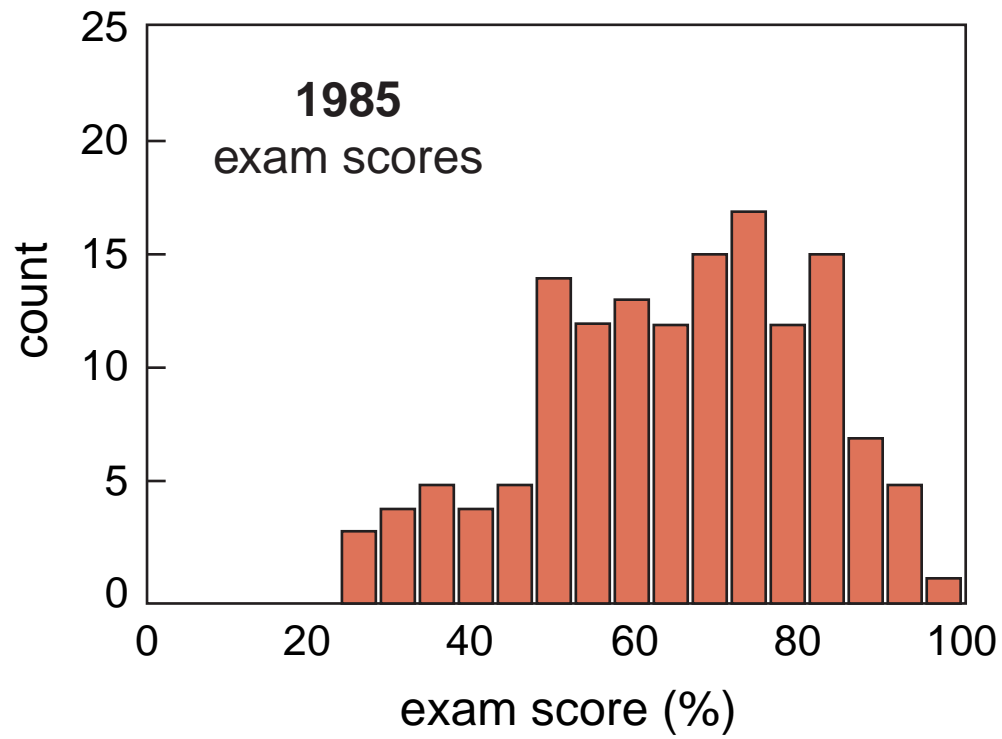

Results

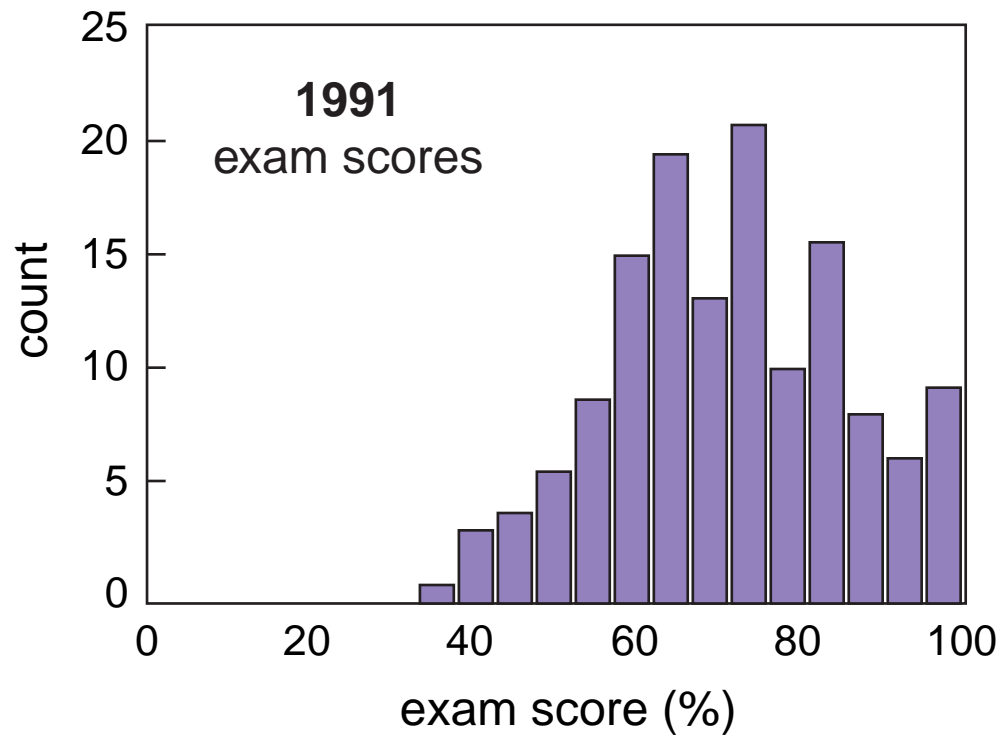

Results

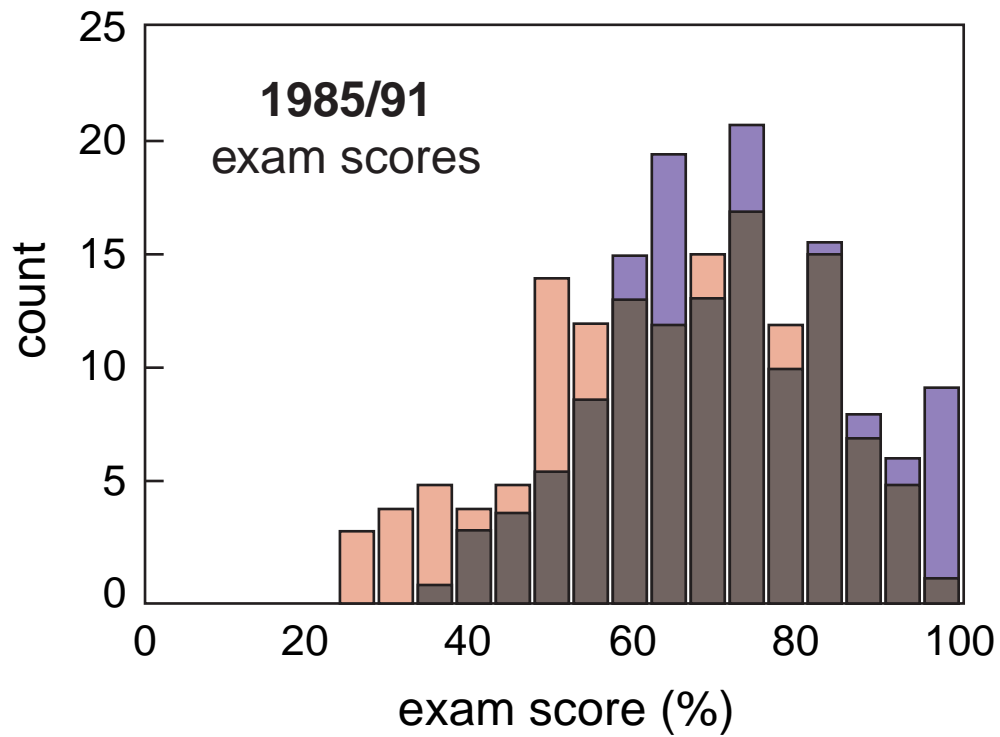

Results

**So better understanding leads to better
problem solving!**

Results

So better understanding leads to better problem solving!

(but “good” problem solving doesn’t always indicate understanding!)

Conclusion

**Let's not forget the base
of the pyramid!**

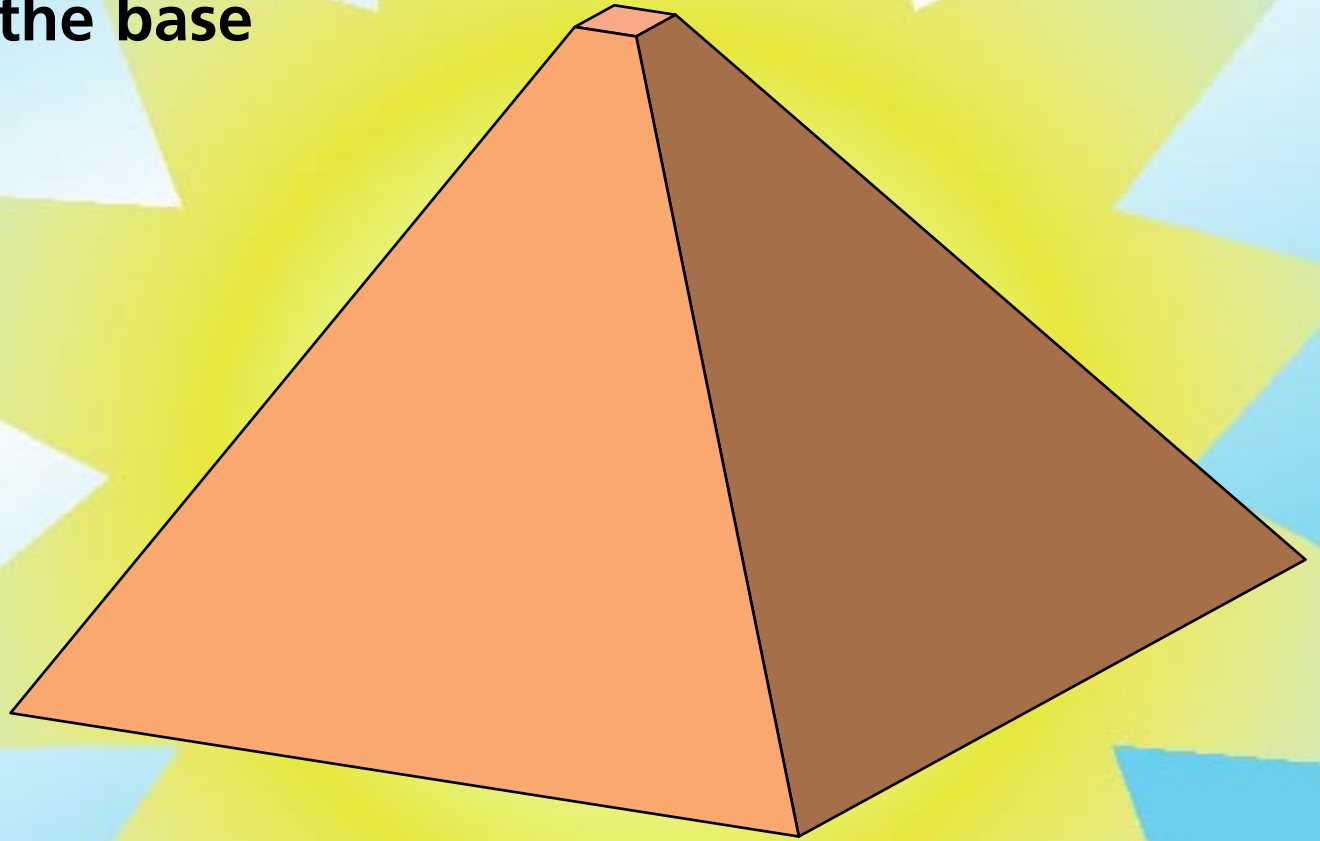

Conclusion

**Let's give them something
of value!**

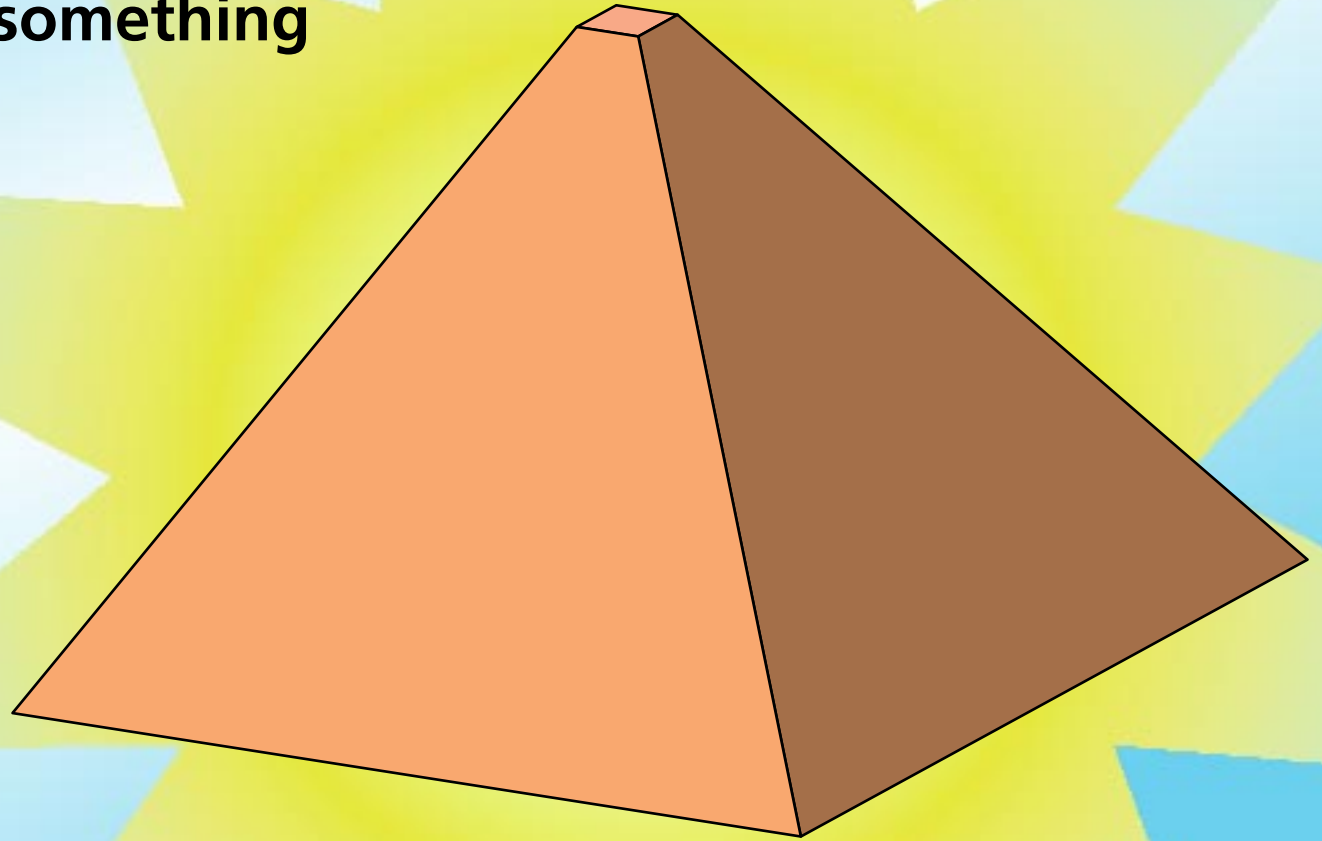

Conclusion

Challenges:

- ▶ **internal skepticism**
- ▶ **growing pains**
- ▶ **limited circle of influence**

Conclusion

Rewards:

- ▶ **engagement**
- ▶ **improved understanding**
- ▶ **class is fun!**

Funding

National Science Foundation

**For a copy of this talk and
additional information:**

<http://mazur-www.harvard.edu>

PEER INSTRUCTION: FROM THEORY TO PRACTICE

Eric Mazur
Harvard University

AAPT New Faculty Meeting
10 November 2000



Outline

- ▶ **Research: providing the basis for change**
- ▶ **ConcepTests: brains-on demo**
- ▶ **Problem with Problems**
- ▶ **Discussion**

Why use Peer Instruction?

Force Concept Inventory data

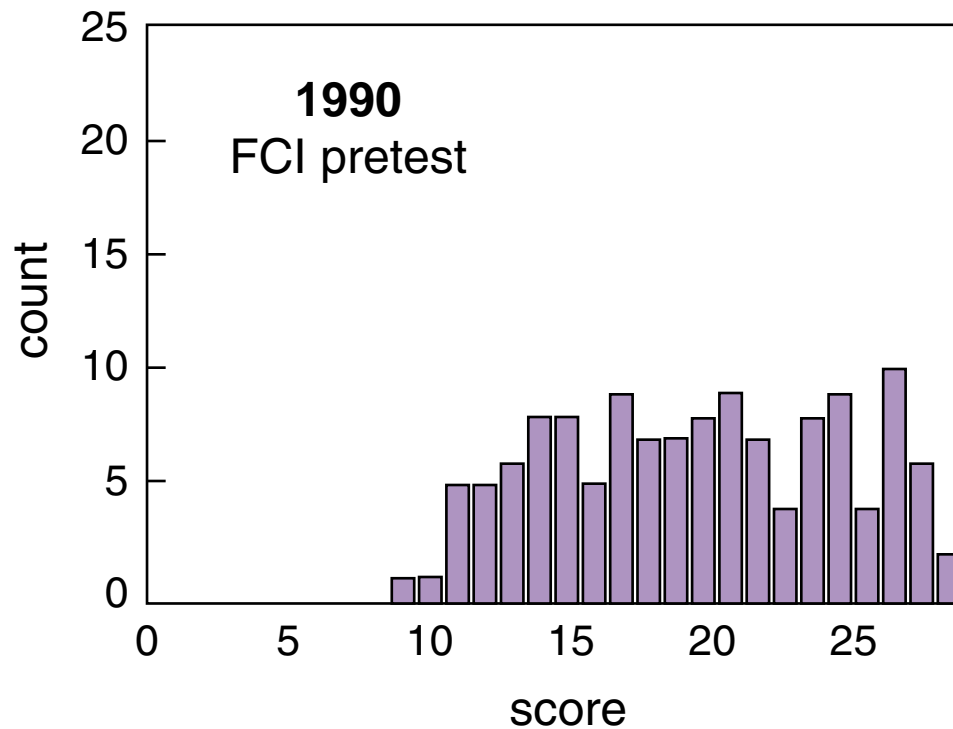

Why use Peer Instruction?

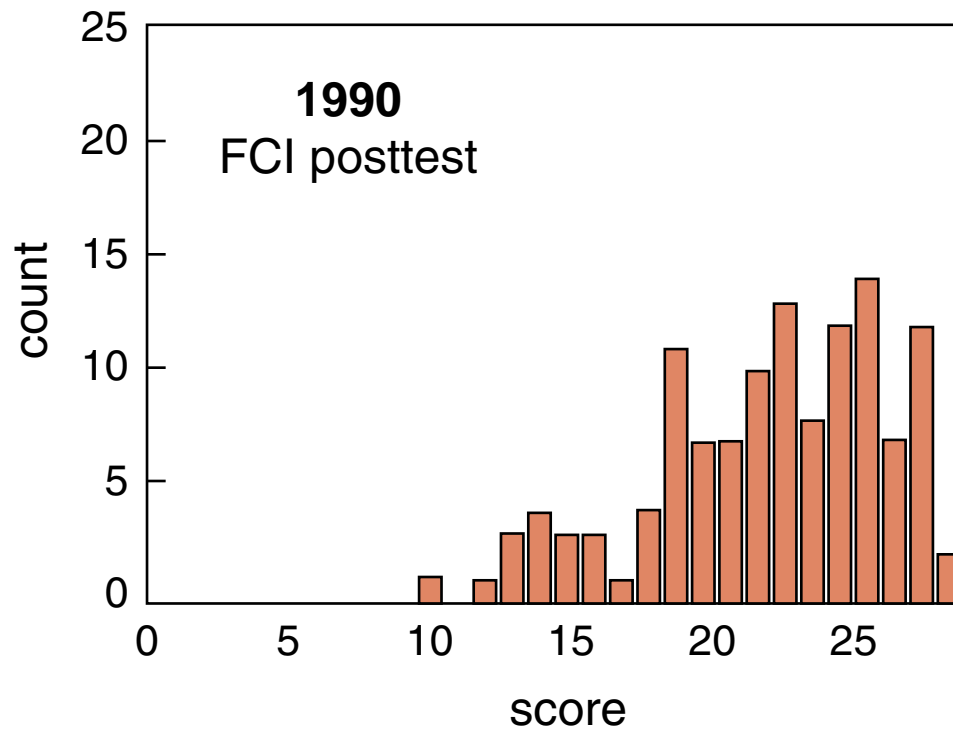

Why use Peer Instruction?

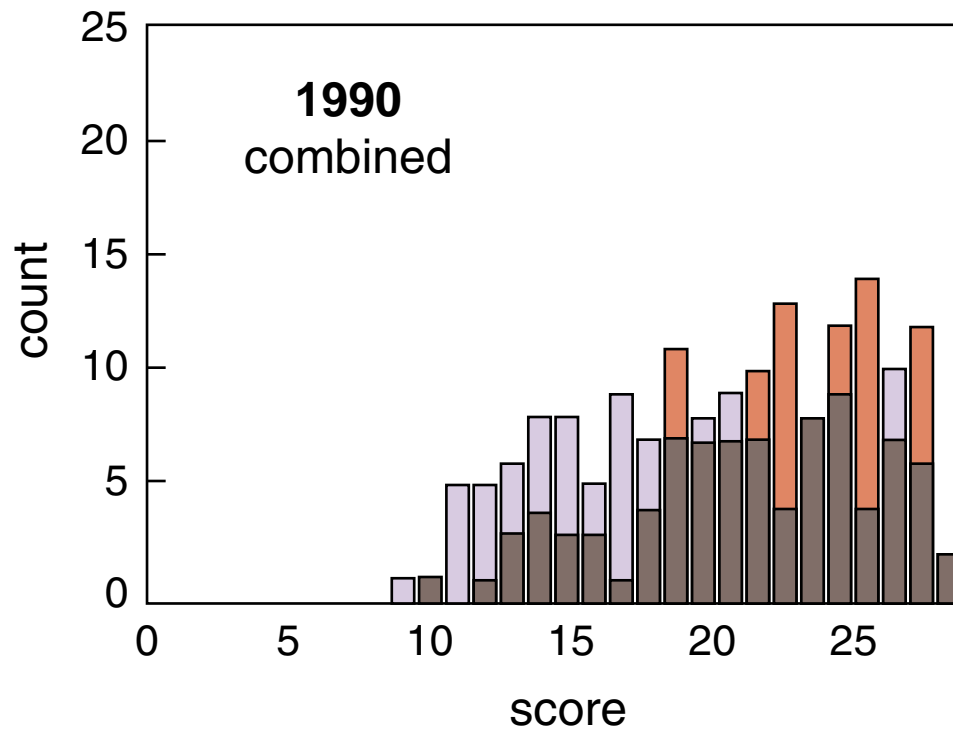

Why use Peer Instruction?

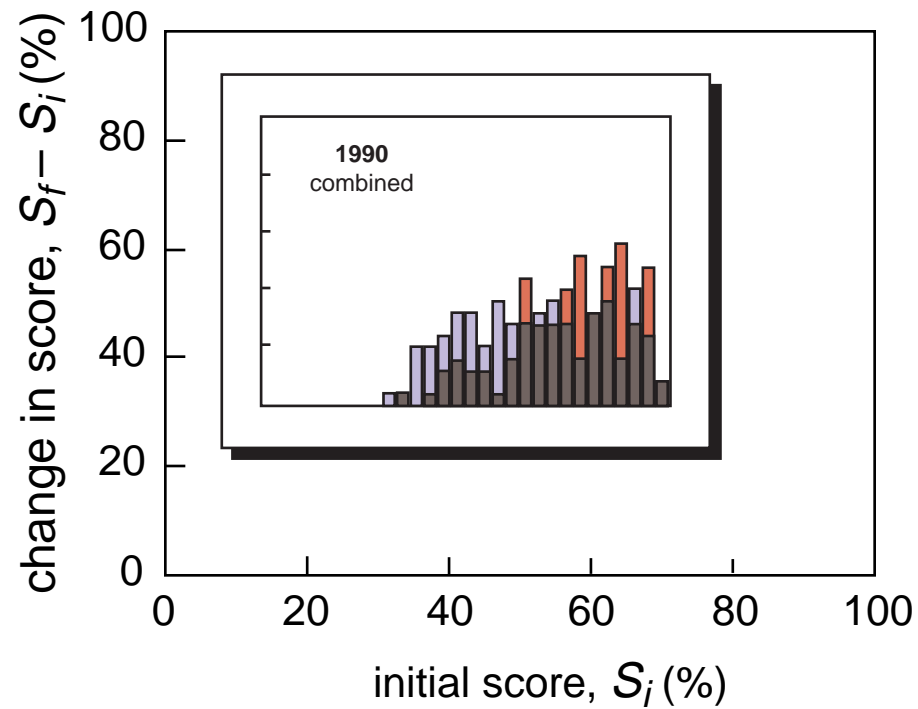

Why use Peer Instruction?

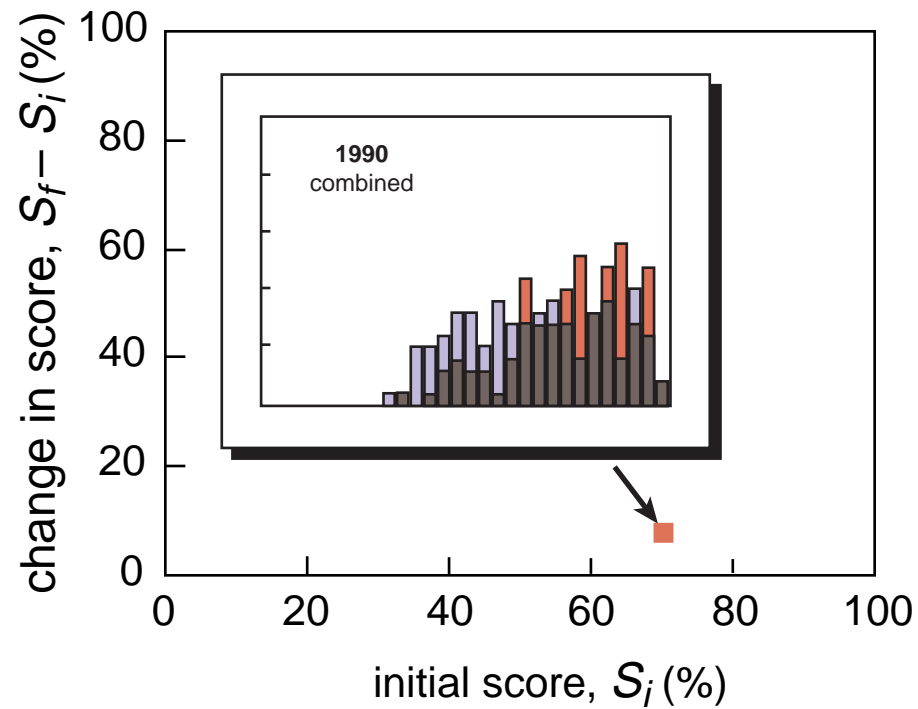

Why use Peer Instruction?

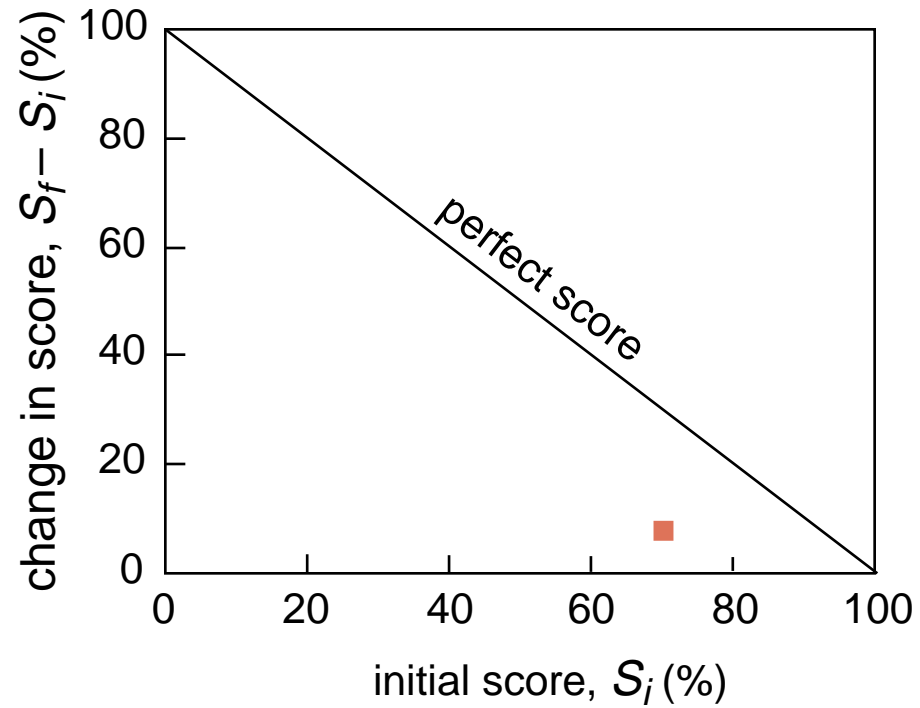

Why use Peer Instruction?

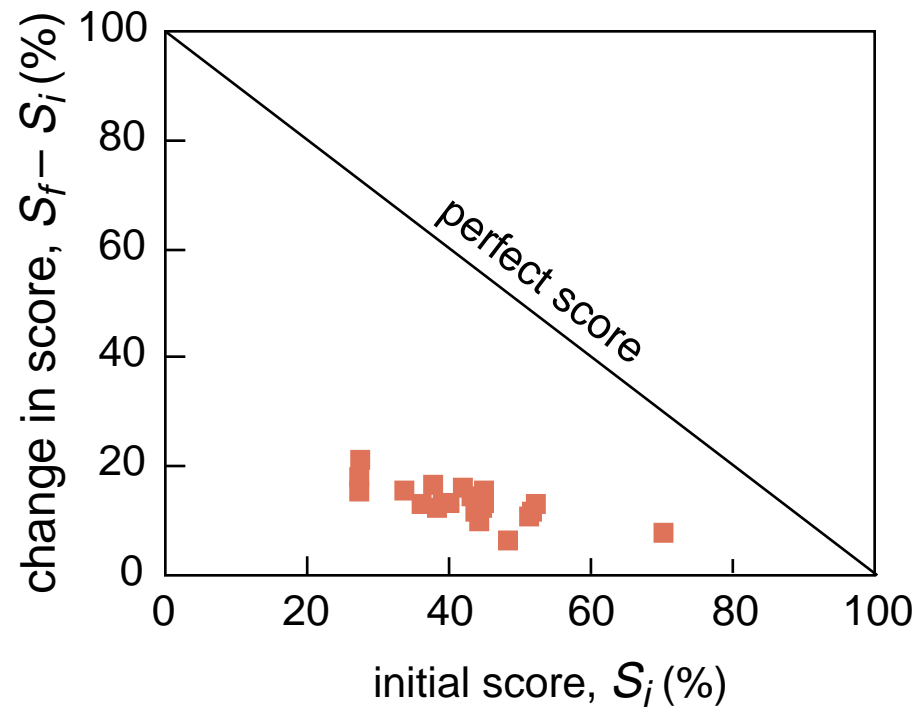

Why use Peer Instruction?

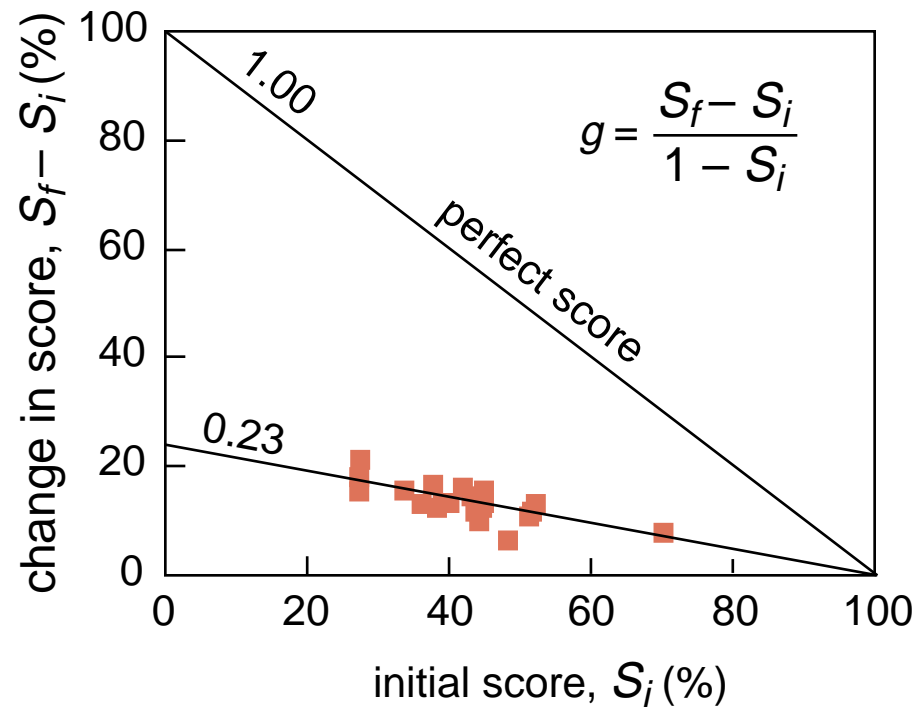

Results

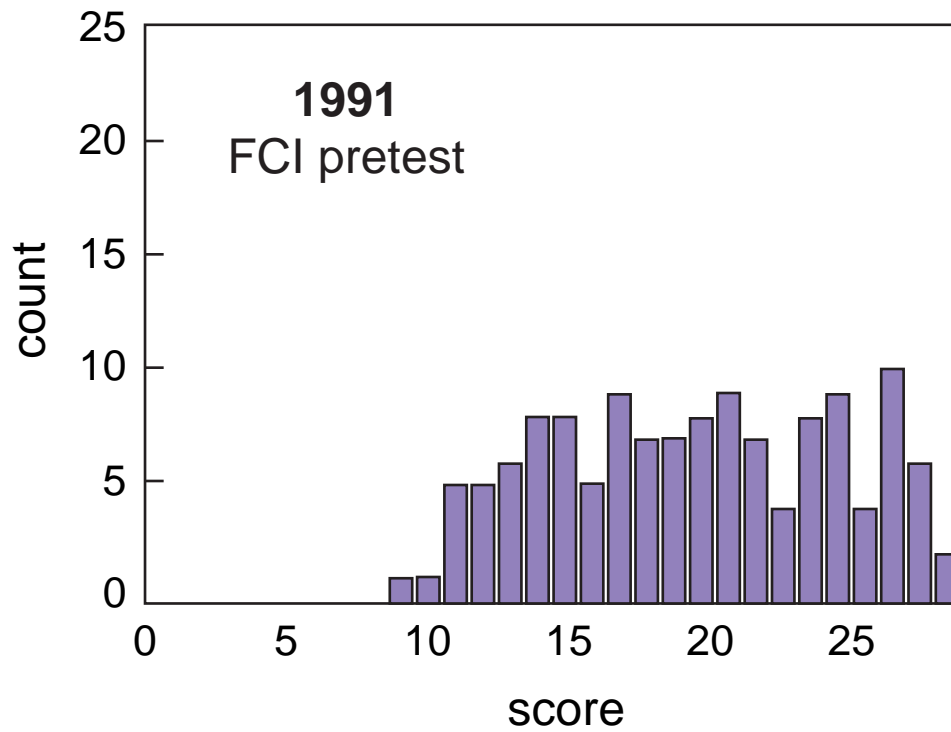

Results

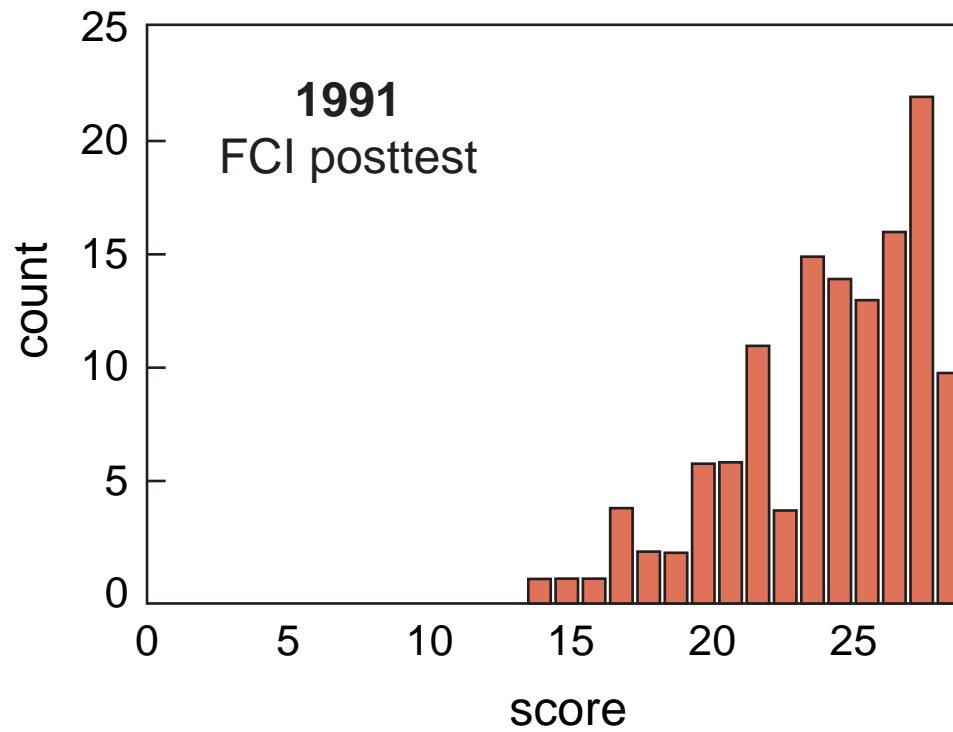

Results

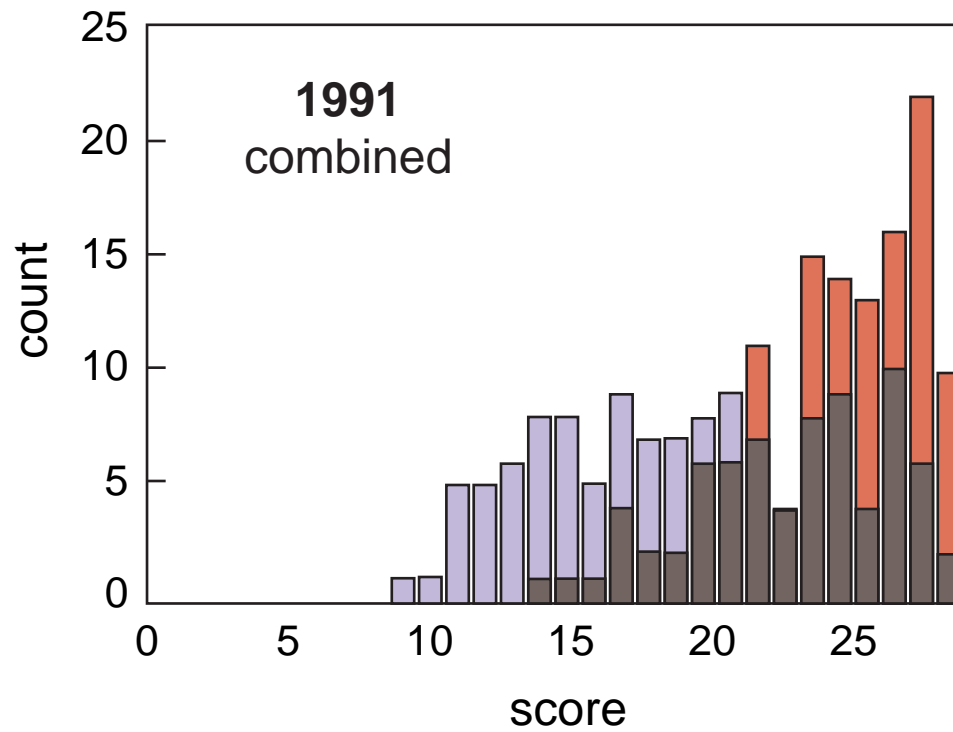

Results

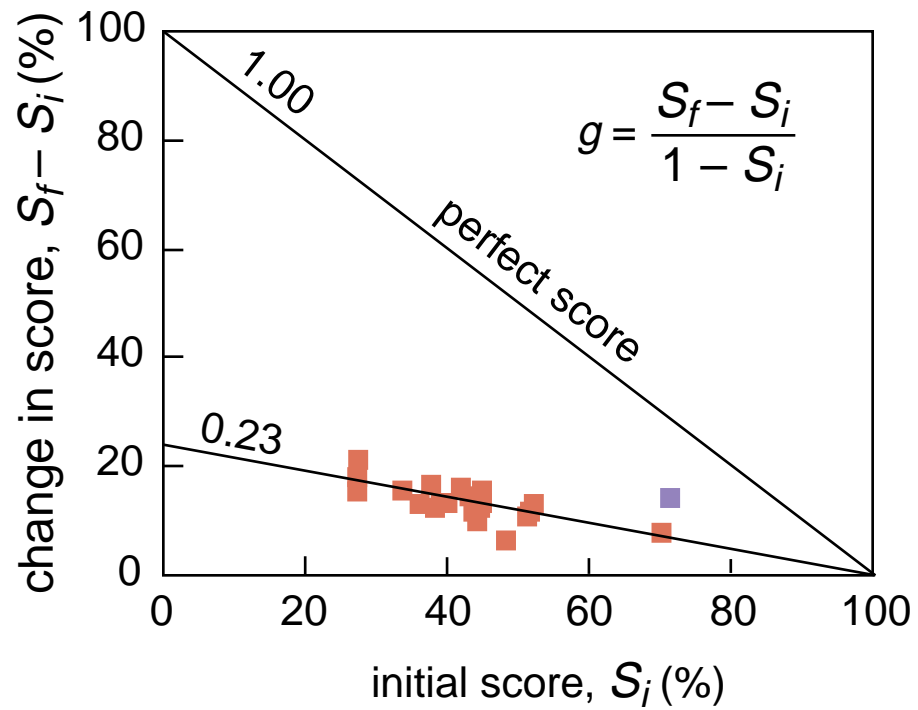

Results

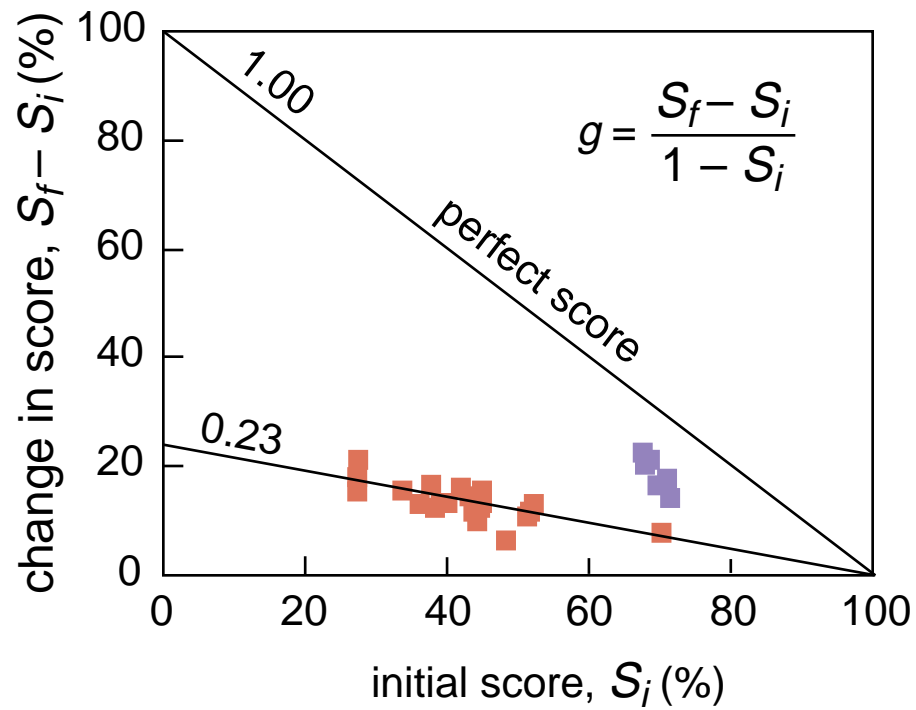

Results

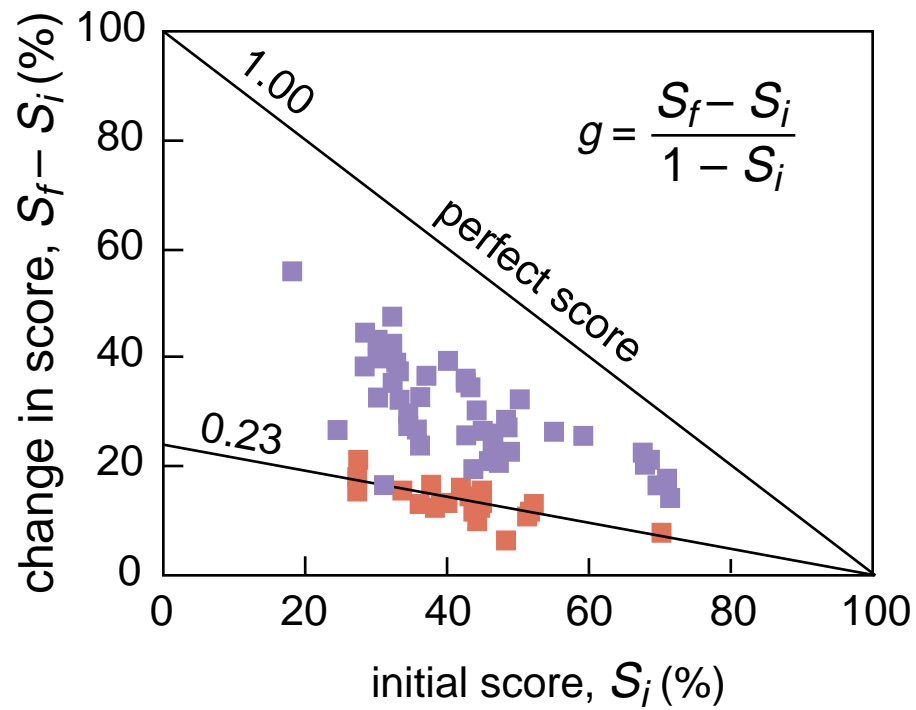

Results

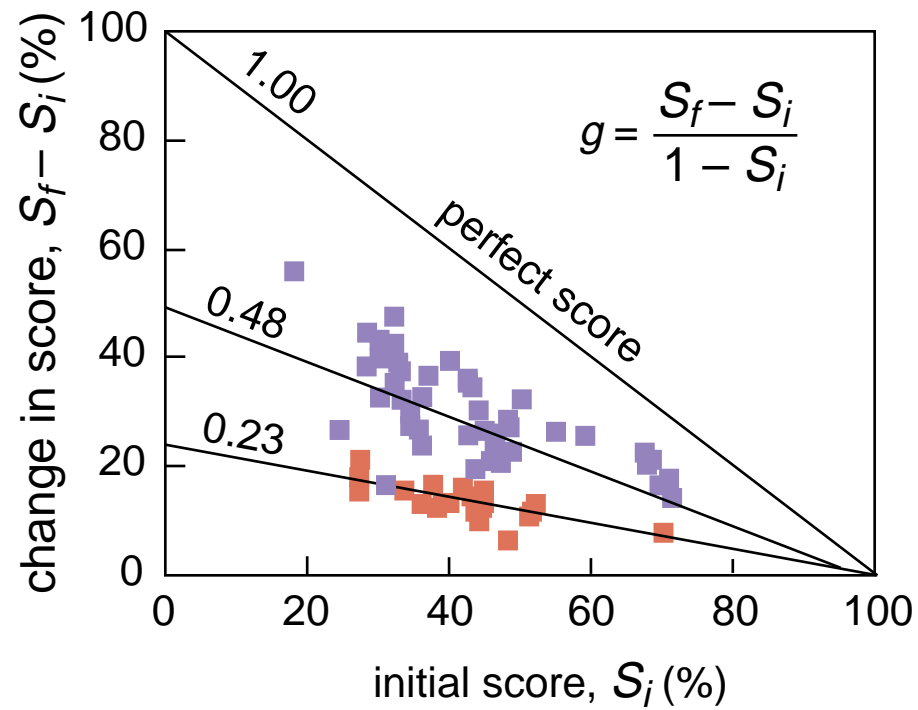

ConcepTest data

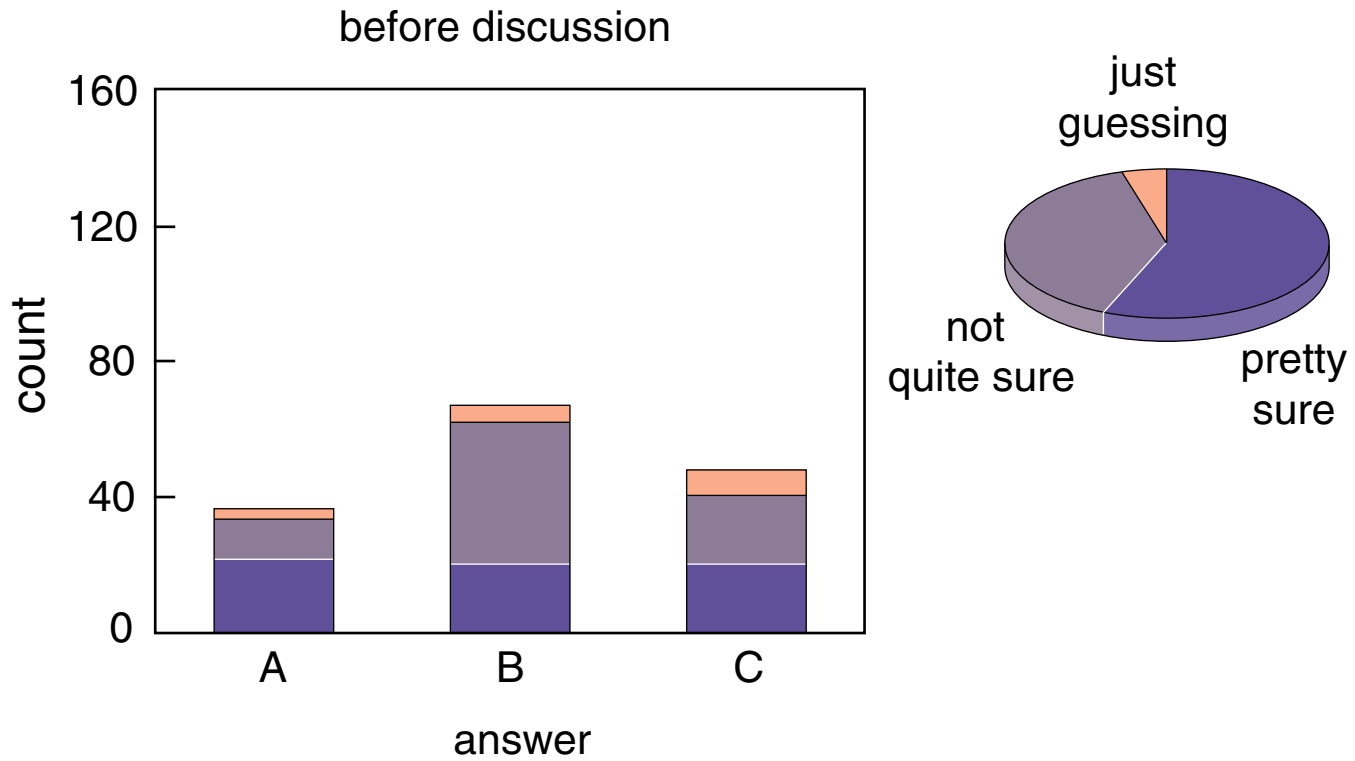

ConcepTest data

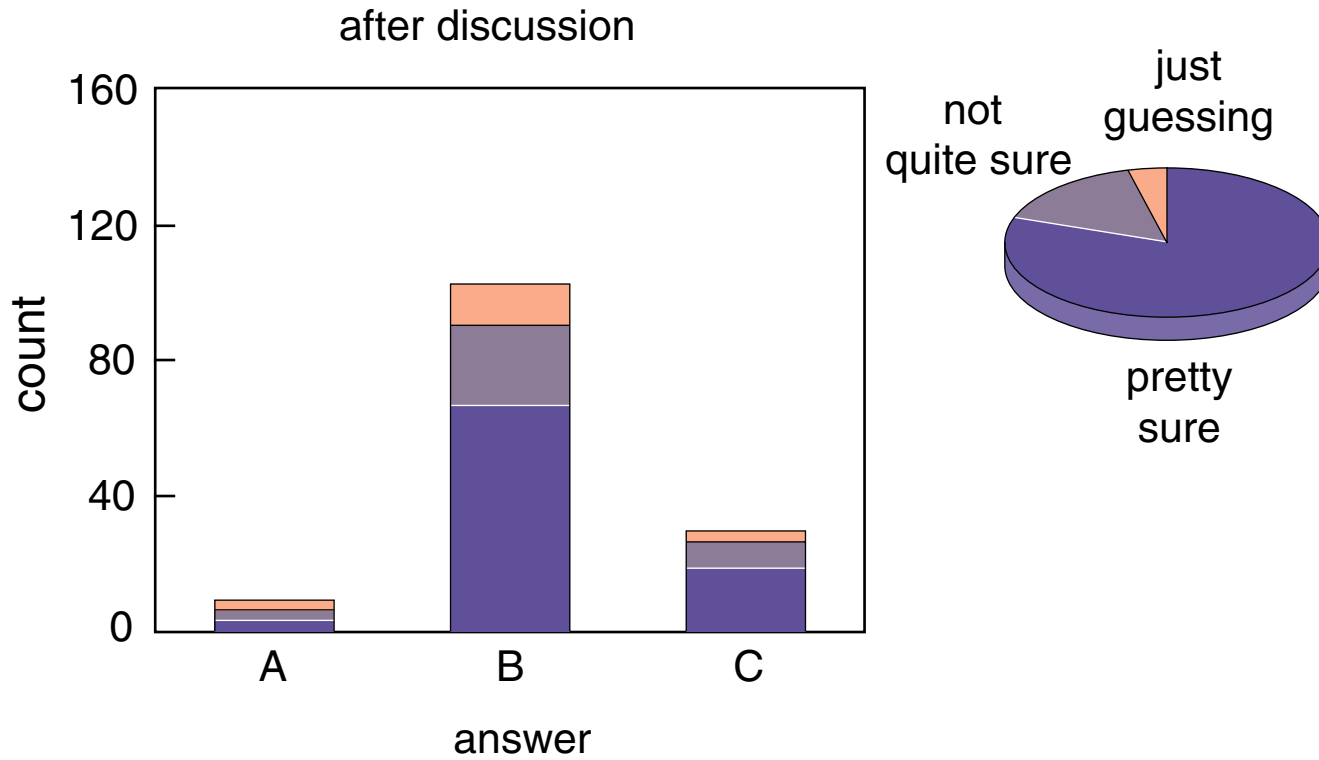

ConcepTest data

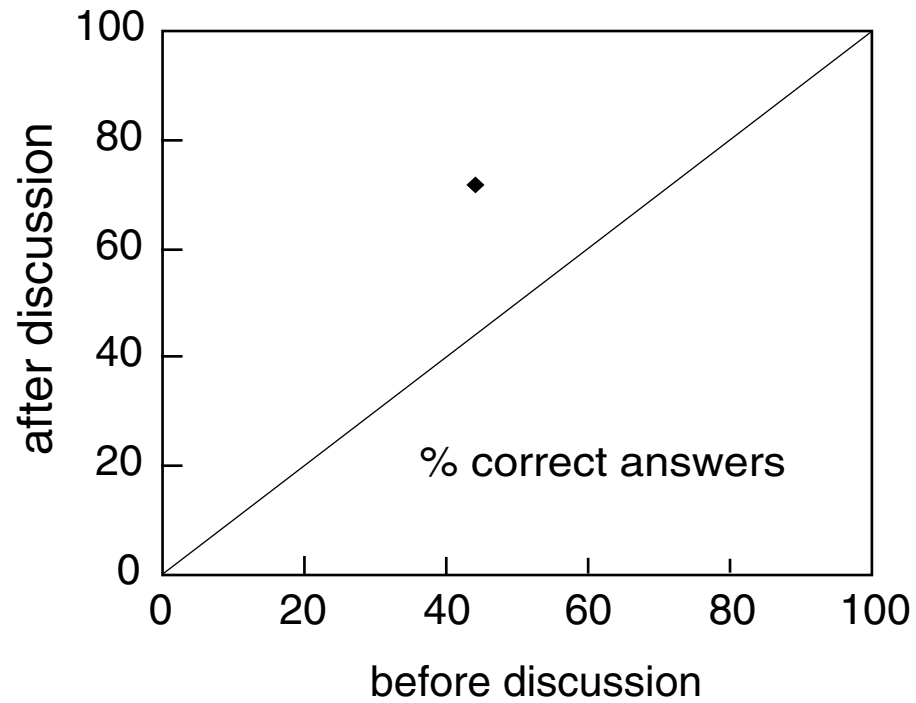

ConcepTest data

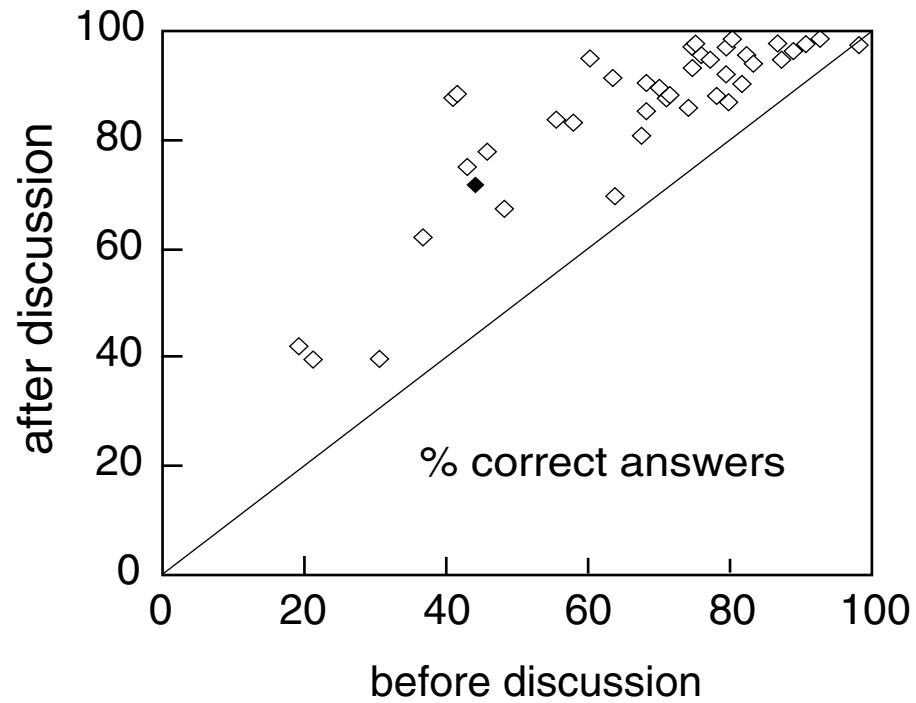

ConcepTest data

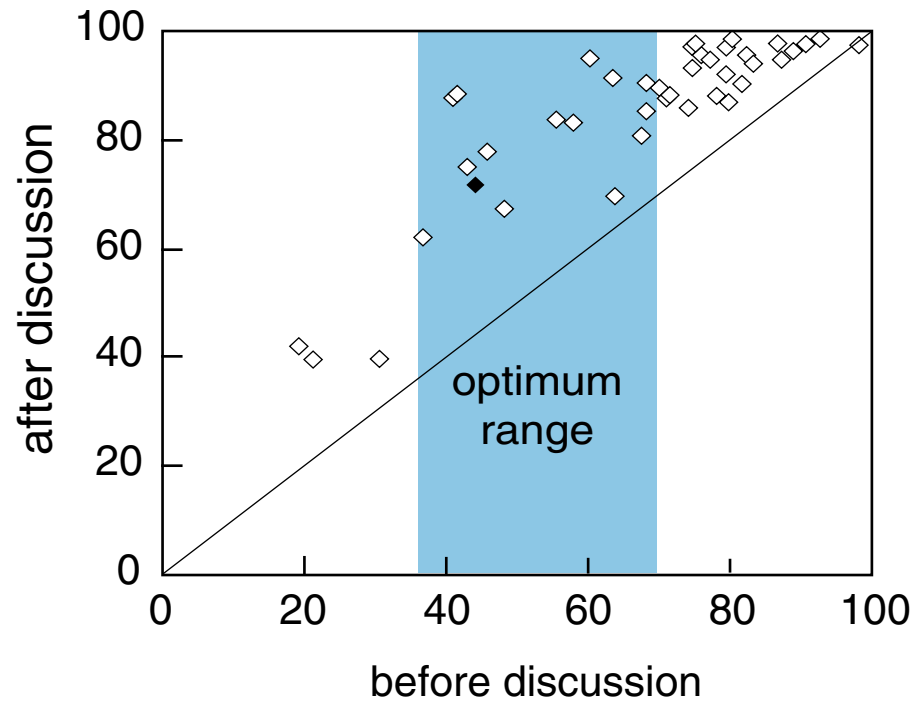

Question 1

Consider a rectangular metal plate with a circular hole in it.

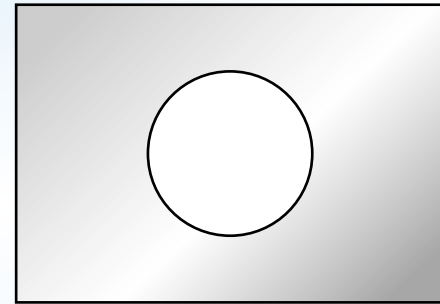

Question 1

Consider a rectangular metal plate with a circular hole in it.

When the plate is uniformly heated, the diameter of the hole

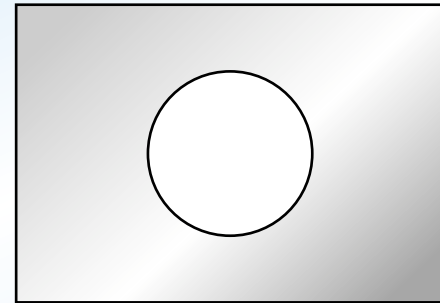

1. increases
2. stays the same
3. decreases

Message 1

It's easy to fire up the audience!

Question 2

A boat carrying a large boulder is floating on a lake. The boulder is thrown overboard and sinks to the bottom of the lake.

Question 2

A boat carrying a large boulder is floating on a lake. The boulder is thrown overboard and sinks to the bottom of the lake.

Does the level of the water in the lake (with respect to the shore)

- 1. go up,**
- 2. go down, or**
- 3. stay the same?**

Message 2

We all make mistakes!

Question 3

Consider an object that floats in water but sinks in oil. When the object floats in water, half of it is submerged.

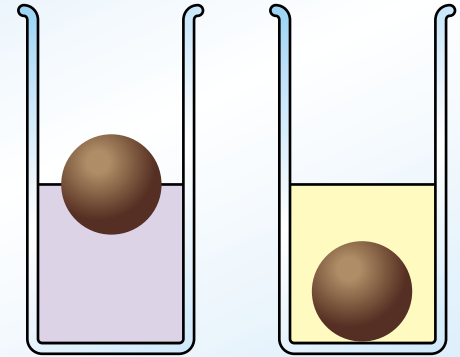

Question 3

Consider an object that floats in water but sinks in oil. When the object floats in water, half of it is submerged.

If we slowly pour oil on top of the water so it completely covers the object, the object

1. moves up.
2. stays in the same place.
3. moves down.

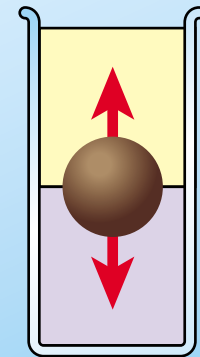
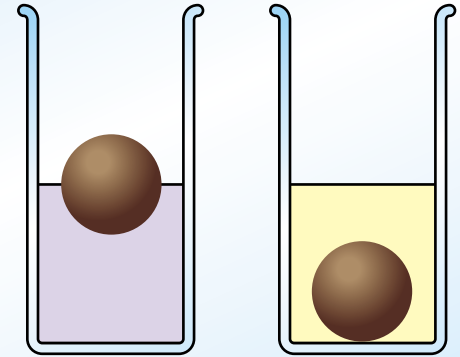

Message 3

It's easy to make simple demonstrations fascinating!

Question 4

When we hold a page of printed text in front of a mirror, the text on the image in the mirror runs from right to left:

The New York Times

Question 4

When we hold a page of printed text in front of a mirror, the text on the image in the mirror runs from right to left:

ɹɐmɪT ʎɪoY wəɪl ɐɪT

Why is it that right and left are interchanged and not top and bottom? Because

1. the mirror is oriented vertically,
2. we have two eyes in the horizontal plane,
3. the Earth's gravitation is directed downward,
4. a habit we have when looking at images in a mirror,
5. It only *appears* to run from left to right.

Message 4

It's "simple" only if you know the answer

Feedback

Flashcards: simple and effective!

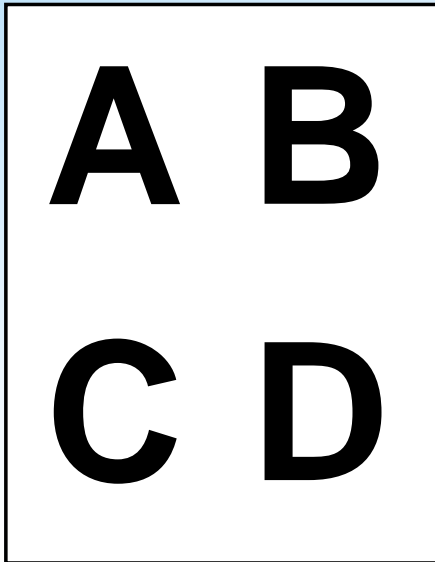

Feedback

Flashcards: simple and effective!

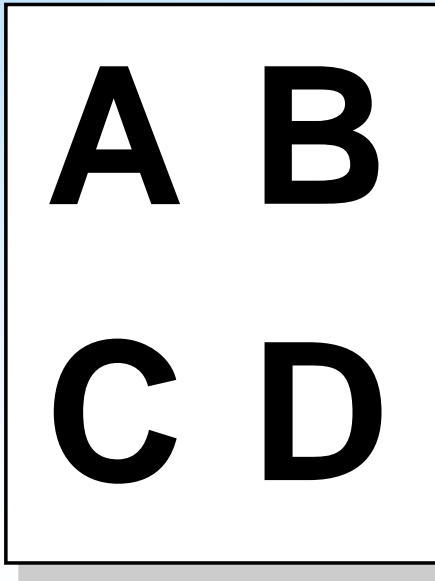

Problem with problems

On a Saturday afternoon, you pull into a parking lot with unmetered spaces near a shopping area. You circle around, but there are no empty spots. You decide to wait at one end of the lot, where you can see (and command) about 20 spaces.

Problem with problems

On a Saturday afternoon, you pull into a parking lot with unmetered spaces near a shopping area. You circle around, but there are no empty spots. You decide to wait at one end of the lot, where you can see (and command) about 20 spaces.

How long do you have to wait before someone frees up a space?

Problem with problems

On a Saturday afternoon, you pull into a parking lot with unmetered spaces near a shopping area. You circle around, but there are no empty spots. You decide to wait at one end of the lot, where you can see (and command) about 20 spaces.

How long do you have to wait before someone frees up a space?

Requires assumptions

Requires developing a model

Requires applying that model

Problem with problems

On a Saturday afternoon, you pull into a parking lot with unmetered spaces near a shopping area. You circle around, but there are no empty spots. You decide to wait at one end of the lot, where you can see (and command) about 20 spaces. **On average people shop for about 2 hours.**

How long do you have to wait before someone frees up a space?

Problem with problems

On a Saturday afternoon, you pull into a parking lot with unmetered spaces near a shopping area. You circle around, but there are no empty spots. You decide to wait at one end of the lot, where you can see (and command) about 20 spaces. **On average people shop for about 2 hours.**

How long do you have to wait before someone frees up a space?

Requires developing a model

Requires applying that model

Problem with problems

On a Saturday afternoon, you pull into a parking lot with unmetered spaces near a shopping area. You circle around, but there are no empty spots. You decide to wait at one end of the lot, where you can see (and command) about 20 spaces. On average people shop for about 2 hours.

Assuming people leave at regularly-spaced intervals, how long do you have to wait before someone frees up a space?

Problem with problems

On a Saturday afternoon, you pull into a parking lot with unmetered spaces near a shopping area. You circle around, but there are no empty spots. You decide to wait at one end of the lot, where you can see (and command) about 20 spaces. On average people shop for about 2 hours.

Assuming people leave at regularly-spaced intervals, how long do you have to wait before someone frees up a space?

Requires applying a (new) model

Problem with problems

On a Saturday afternoon, you pull into a parking lot with unmetered spaces near a shopping area where people are known to shop, on average, for two hours. You circle around, but there are no empty spots. You decide to wait at one end of the lot, where you can see (and command) about 20 spaces.

How long do you have to wait before someone frees up a space?

Problem with problems

On a Saturday afternoon, you pull into a parking lot with unmetered spaces near a shopping area where people are known to shop, on average, for two hours. You circle around, but there are no empty spots. You decide to wait at one end of the lot, where you can see (and command) about 20 spaces.

How long do you have to wait before someone frees up a space?

$$t_{wait} = \frac{T_{shop}}{N_{spaces}}$$

Problem with problems

On a Saturday afternoon, you pull into a parking lot with unmetered spaces near a shopping area where people are known to shop, on average, for two hours. You circle around, but there are no empty spots. You decide to wait at one end of the lot, where you can see (and command) about 20 spaces.

How long do you have to wait before someone frees up a space?

Requires using a calculator

$$t_{wait} = \frac{T_{shop}}{N_{spaces}}$$

Essential elements

- ▶ **Reading (before class)**
- ▶ **Participation (during class)**
- ▶ **Problem-solving (after class)**
- ▶ **Appropriate testing/assessment**

Coverage

traditional

coverage

encyclopedic

retention

disappointing

Coverage

	traditional	interactive
coverage	encyclopedic	less?
retention	disappointing	more!

Coverage

	traditional	interactive
coverage	encyclopedic	less?
retention	disappointing	more!

***“What counts is not how much is covered,
but how much is uncovered”***

Viki Weisskopf

Reading

- ▶ **Web-based assignment due before class**

Reading

- ▶ **Web-based assignment due before class**
- ▶ **Three questions (content and feedback)**

Reading

- ▶ **Web-based assignment due before class**
- ▶ **Three questions (content and feedback)**
- ▶ **Graded on effort**

Reading

- ▶ **Web-based assignment due before class**
- ▶ **Three questions (content and feedback)**
- ▶ **Graded on effort**
- ▶ **5% of final grade**

Who benefits?

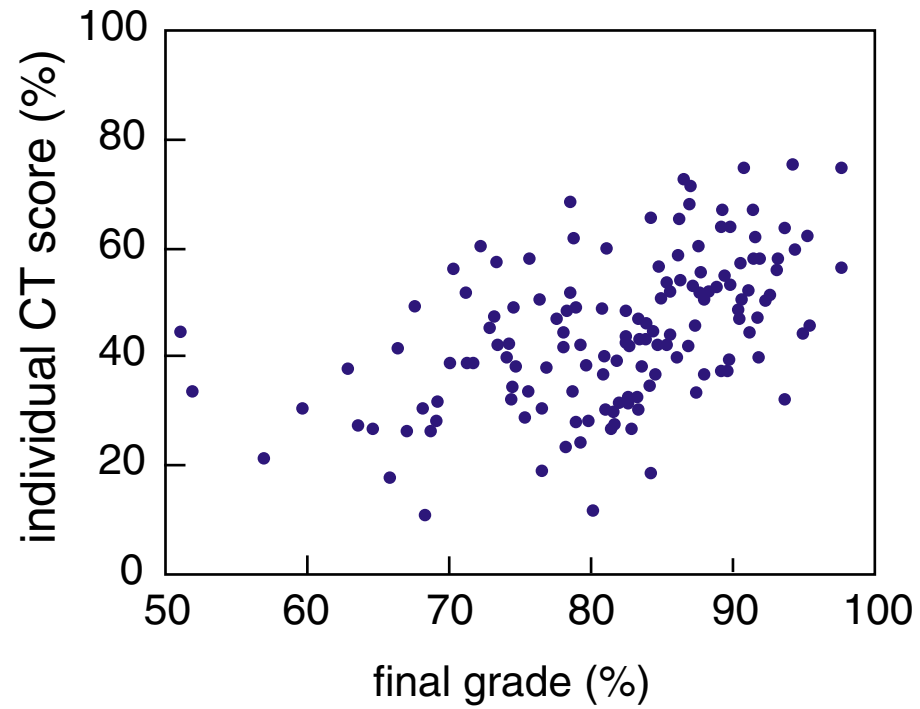

Who benefits?

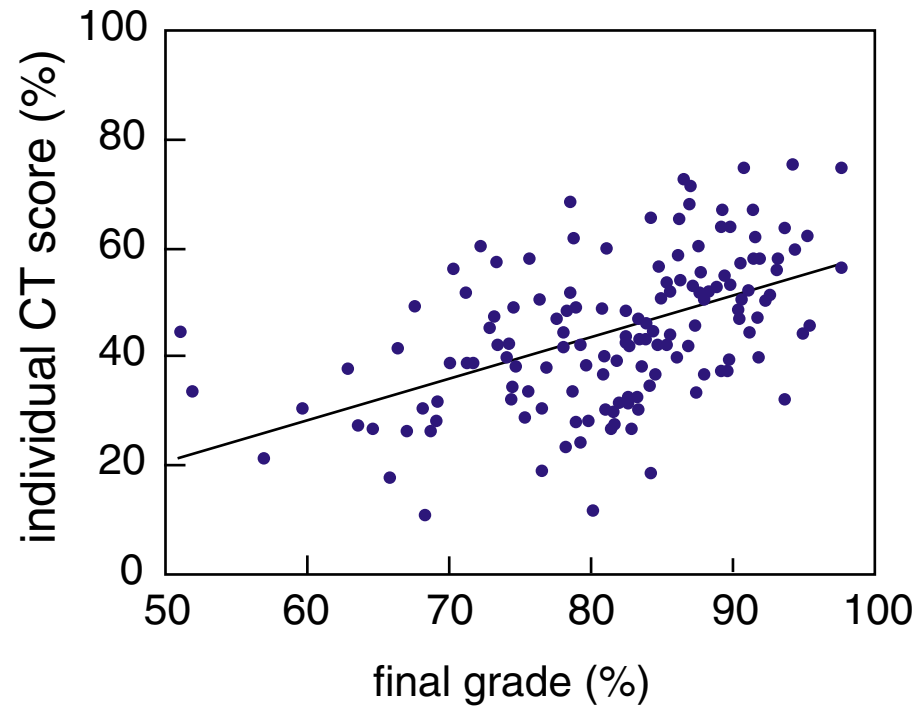

Who benefits?

even best students are challenged!

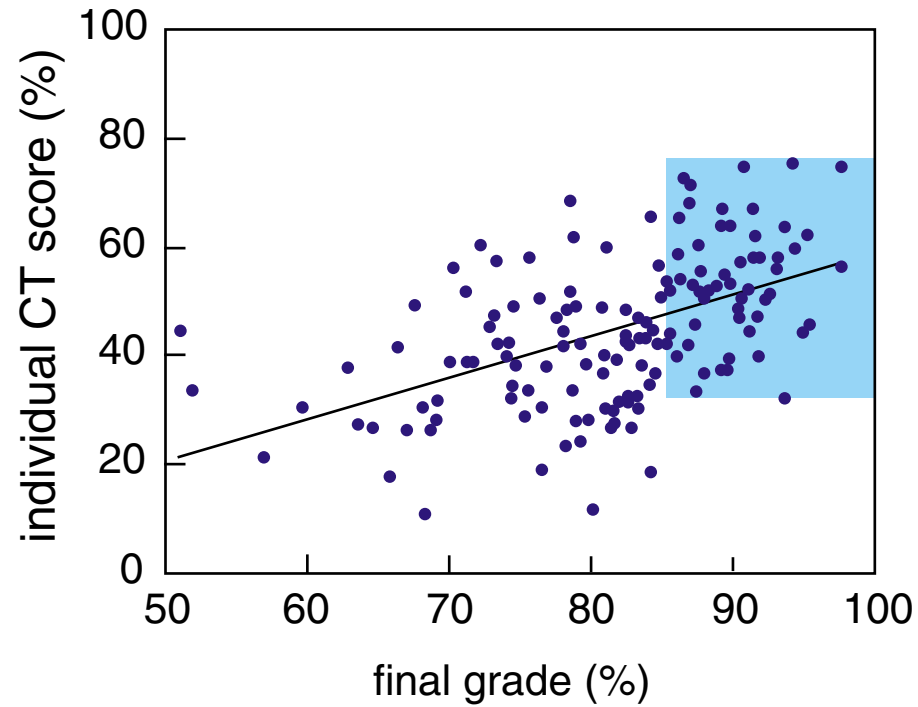

Who benefits?

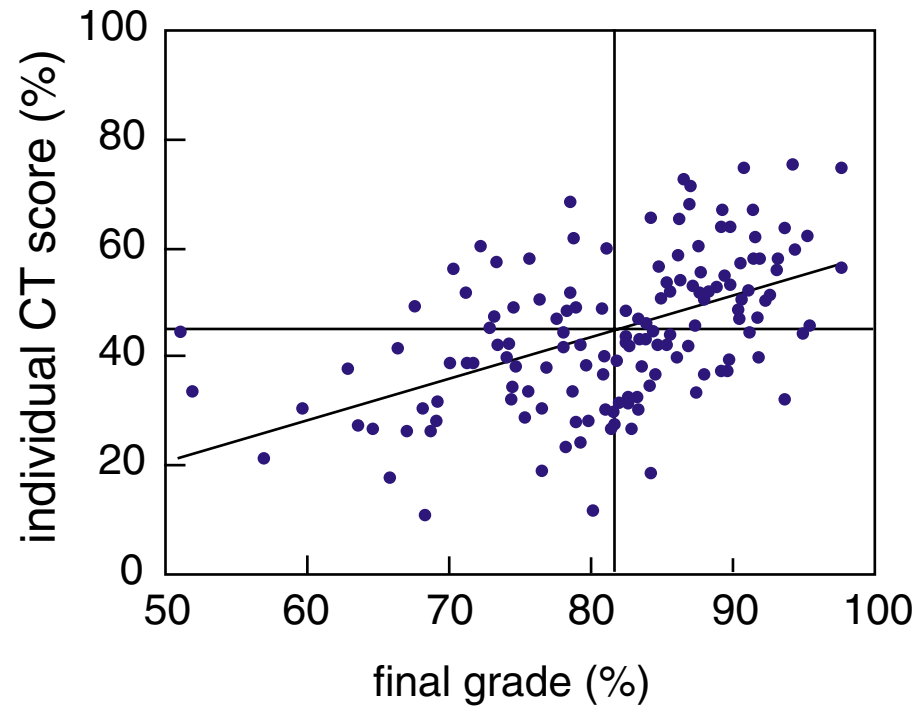

Resources

***Peer Instruction: A User's Manual* (Prentice Hall, 1997)**

<http://galileo.harvard.edu>

Funding

National Science Foundation

**For a copy of this talk and
additional information:**

<http://mazur-www.harvard.edu>