

Femtosecond laser micromachining: applications in technology and biology



Carnegie Mellon University and University of Pittsburgh
Pittsburgh, PA, 5 April 2004





Rafael Gattass



Iva Maxwell



Sam Chung



Alex Heisterkamp

and also....

Loren Cerami

Eli Glezer

Chris Schaffer

Nozomi Nishimura

Jonathan Ashcom

Nan Shen

Debyoti Datta

Dr. André Brodeur

Dr. Limin Tong

Prof. Donald Ingber (Childrens Hospital)

Dr. Sanjay Kumar (Childrens Hospital)

Prof. Philip LeDuc (Carnegie Mellon)

Prof. Aravi Samuel (Harvard)

Introduction

Laser-Induced Electric Breakdown in Solids

NICOLAAS BLOEMBERGEN, FELLOW, IEEE

Abstract—A review is given of recent experimental results on laser-induced electric breakdown in transparent optical solid materials. A fundamental breakdown threshold exists characteristic for each material. The threshold is determined by the same physical process as dc breakdown, namely, avalanche ionization. The dependence of the threshold on laser pulse duration and frequency is consistent with this process. The implication of this breakdown mechanism for laser bulk and surface damage to optical components is discussed. It also determines physical properties of self-focused filaments.

I. INTRODUCTION

THE history of laser-induced electric breakdown is almost as old as the history of lasers itself. Early in 1963 Maker *et al.* [1] reported damage to transparent dielectrics and the production of a spark in air by focusing a pulsed ruby laser beam. The importance of these experiments in the production of laser-induced dense

plasmas and for the propagation characteristics of high-power laser beams through solids, liquids, and gases was quickly recognized. The subject of electric breakdown in transparent optical solids, including laser materials, windows, and other optical components, remained, until recently, largely an empirical or engineering science. Although a vast amount of theoretical and experimental effort was expended in the economically and experimentally important problem of optical damage, quantitative reproducible breakdown thresholds with unambiguous theoretical interpretations have been obtained only during the last two years. The situation was somewhat analogous to the development of our understanding of the problem of dc breakdown in electrical insulators. There, too, the field developed largely by engineering trial and error. Basic quantitative understanding was not achieved until reproducible experimental results on well-defined materials were obtained [2]. The difficulties in dc breakdown experiments were manifold: the influence of space charges, the occurrence of heating due to the effects of heating due to a few elec-

Introduction

Laser-Induced Electric Breakdown in Solids

NICOLAS BLOEMBERGEN, ILLINOIS, U.S.A.

Abstract: A review is given of recent experimental results on laser-induced electric breakdown in transparent optical solid materials. A fundamental breakdown threshold exists characteristic for each material. The threshold is determined by the same physical process as dielectric breakdown, namely, avalanche ionization. The dependence of the threshold on laser pulse intensity and frequency is consistent with this process. The implication of this breakdown mechanism for laser bulk and surface damage components is discussed. It also determines physical properties of self-focused beams.

1. INTRODUCTION

THE history of laser-induced electric breakdown is almost as old as the history of lasers itself. Early in 1963 Mallet et al. reported the production of a spark in an optically transparent dielectric and the production of a striation in a frequency-multiplexed ruby laser beam. The importance of these phenomena in the production of laser-induced surface

plasmas and for the propagation characteristics of high-power laser beams through solids, liquids, and gases was quickly realized. The subject of electric breakdown in transparent optical solids, including laser materials, was done, and other optical components, remained, and recently, largely an empirical or engineering science. Although a lot of work in theoretical and experimental studies was expended in the economically and technically important problem of optical damage thresholds, reproducibly breakdown thresholds with unambiguous theoretical interpretations have been obtained only during the last two years. The situation was somewhat analogous to the development of our understanding of the problem of dielectric breakdown in electrical insulators. There too the breakdown levels by experimental trial and error. Basic quantitative understanding was not achieved until reproducibly experimental results on well-defined materials were obtained [2]. The difficulties in obtaining quantitative experimental results on well-defined materials were manifold: the influence of surface damage, the occurrence of space charge, the effects of heating and

Introduction

DAMAGED

STP 1141

22nd ANNUAL BOULDER DAMAGE SYMPOSIUM
Proceedings



LASER-INDUCED DAMAGE
IN OPTICAL MATERIALS: 1990

24-26 OCTOBER 1990
BOULDER, COLORADO

Introduction

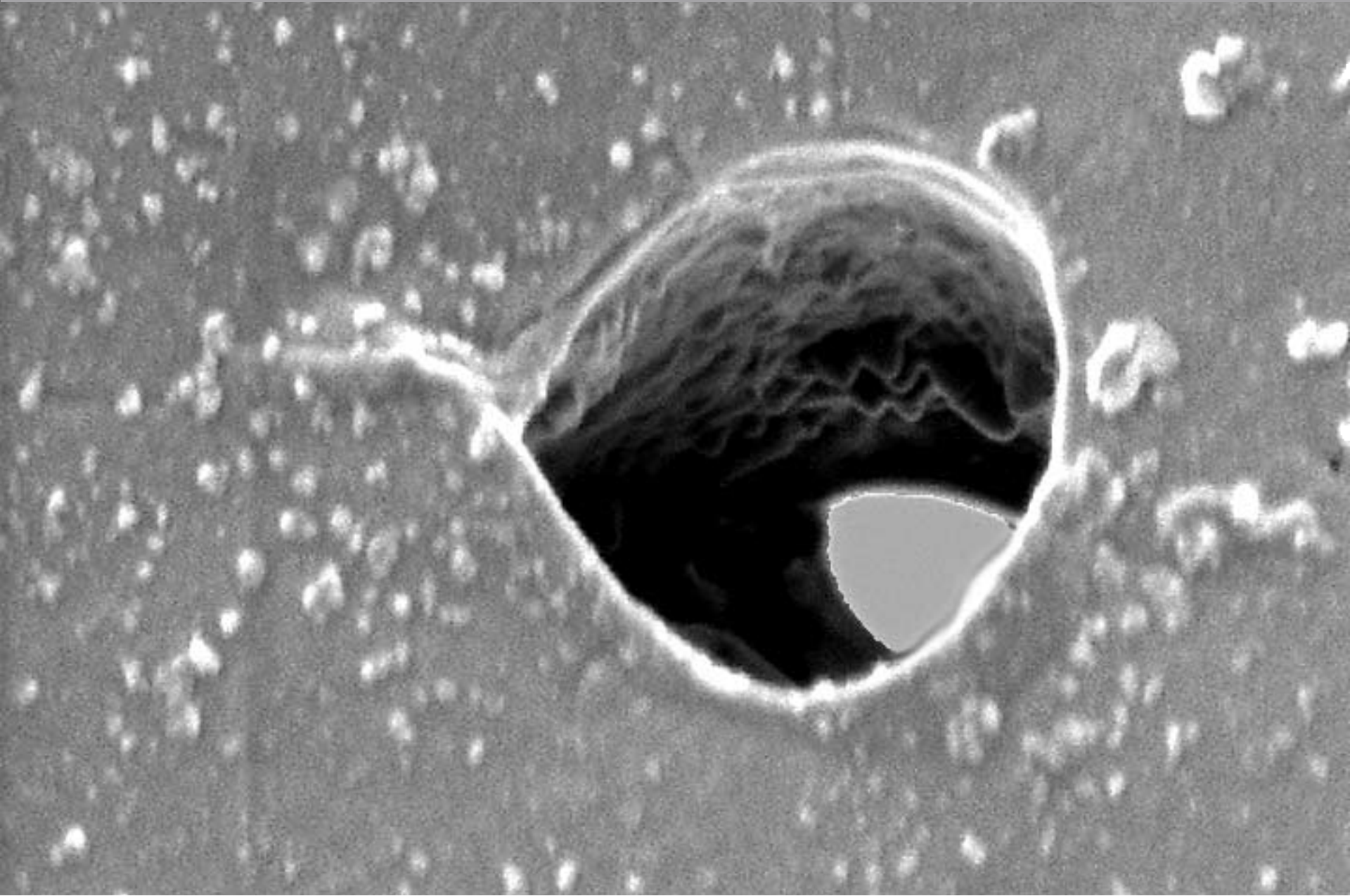

Introduction

use damage for processing!

Outline

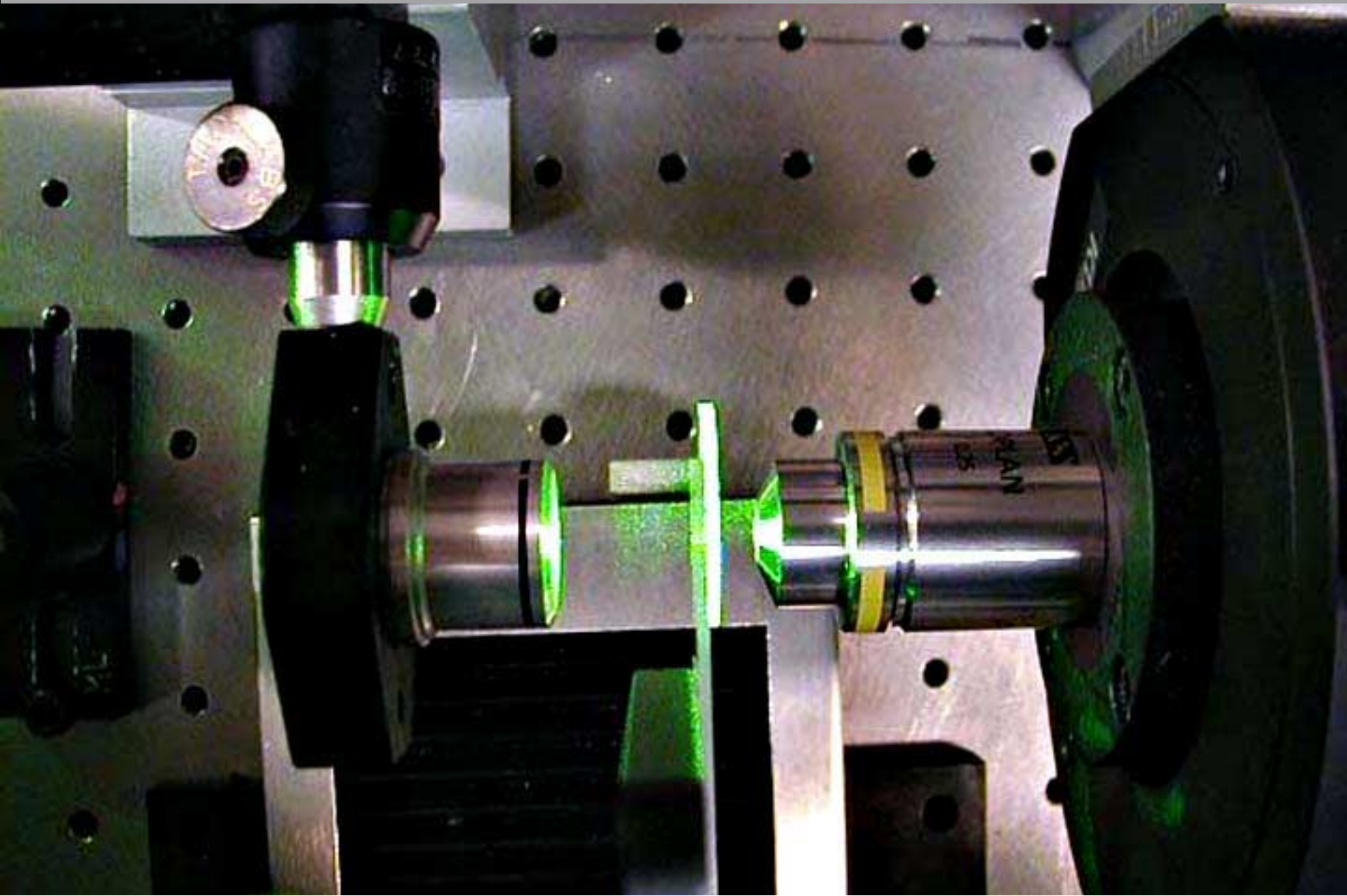

Outline

- ▶ **Processing with fs pulses**
- ▶ **Role of focusing**
- ▶ **Low-energy processing**

Processing with fs pulses

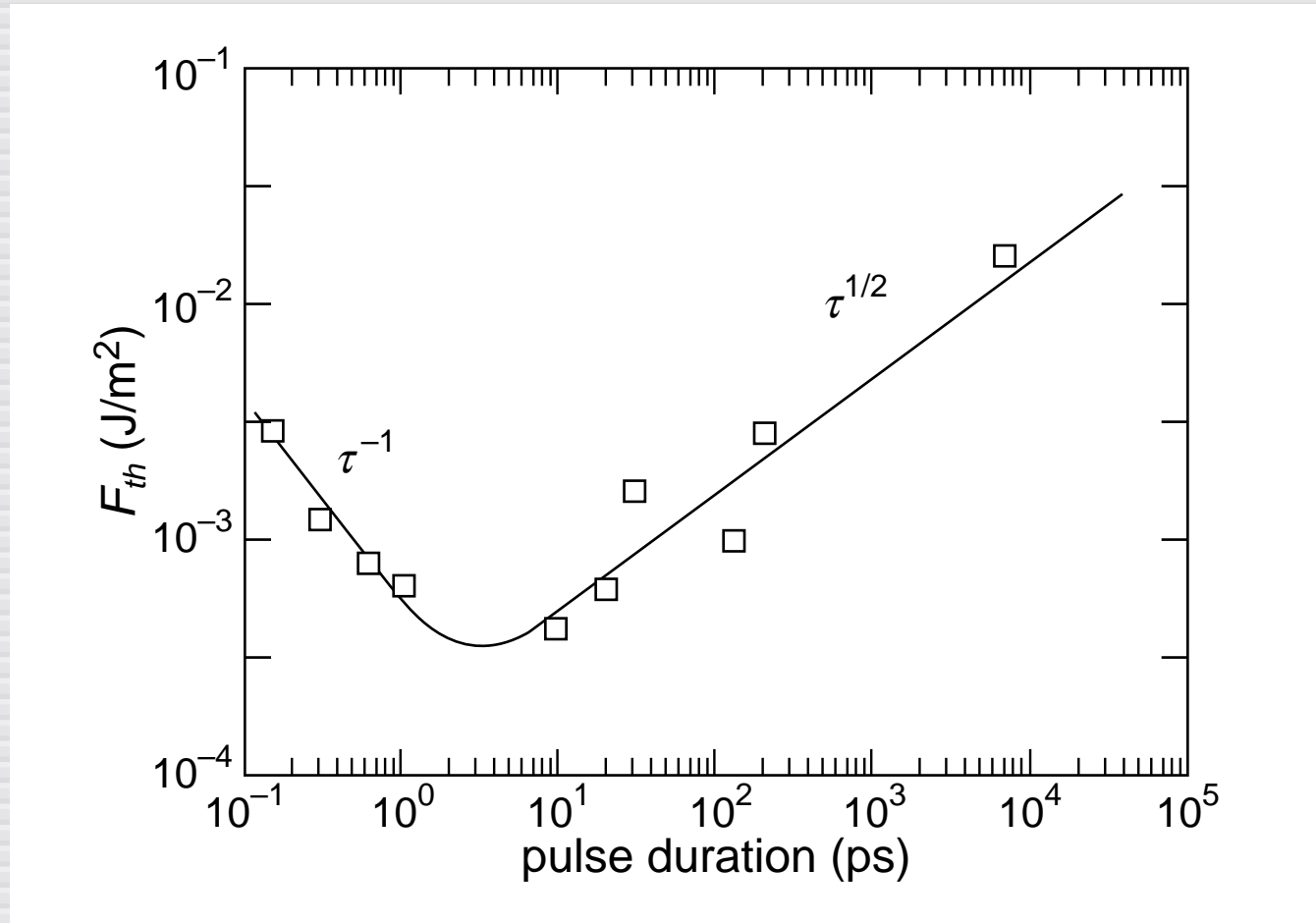

Du et al., *Appl. Phys. Lett.* 64, 3071 (1994)

Processing with fs pulses

216

J. Opt. Soc. Am. B/Vol. 13, No. 1/January 1996

Breakdown threshold and plasma formation in femtosecond laser–solid interaction

D. von der Linde and H. Schüler

D. von der Linde and H. Schüler

Institut für Laser- und Plasmaphysik, Universität Essen, D-45117 Essen, Germany

Received March 6, 1995; revised manuscript received June 15, 1995

Combining femtosecond pump–probe techniques with optical microscopy, we have studied laser-induced optical breakdown in optically transparent solids with high temporal and spatial resolution. The threshold of plasma formation has been determined from measurements of the changes of the optical reflectivity associated with the developing plasma. It is shown that plasma generation and material damage in the interaction of femtosecond laser pulses with bulk optical materials. © 1996 Optical Society of America

1. INTRODUCTION

The interaction of intense femtosecond laser pulses with solids offers the possibility of producing a new class of plasmas having approximately solid-state density and spatial density scale lengths much smaller than the wavelength of light. These high-density plasmas with extremely sharp density gradients are currently of great interest, particularly from the point of view of generating short x-ray pulses. To produce such a plasma, the intensity level must rise from the intensity level of the plasma formation to the plasma scale

One of the key points in the research of Bloembergen and his co-workers was the use of very tightly focused laser beams, which allowed them to reach the breakdown threshold of the materials while staying well below the critical power of self-focusing. Self-focusing is one of the major problems in the measurement of bulk breakdown thresholds. In a more recent review Soileau *et al.*⁵ carefully examined the role of self-focusing in experiments measuring laser-induced breakdown of bulk dielectric materials. They concluded that the breakdown and damage thresholds are also strongly influenced by extrinsic effects.

Thus far, the issue of breakdown thresholds in femtosecond laser–solid interaction has barely been touched. Recently, Du *et al.*⁶ carried out laser-induced breakdown experiments on fused silica with pulses ranging in duration from 100 to 150 fs. They reported a breakdown threshold of the

Processing with fs pulses

**"... clear evidence that no bulk plasmas ...
[and] ... no bulk damage could be produced
with femtosecond laser pulses."**

von der Linde, *et al.*, *J. Opt. Soc. Am.* **13**, 216 (1996)

Processing with fs pulses

focus laser beam inside material

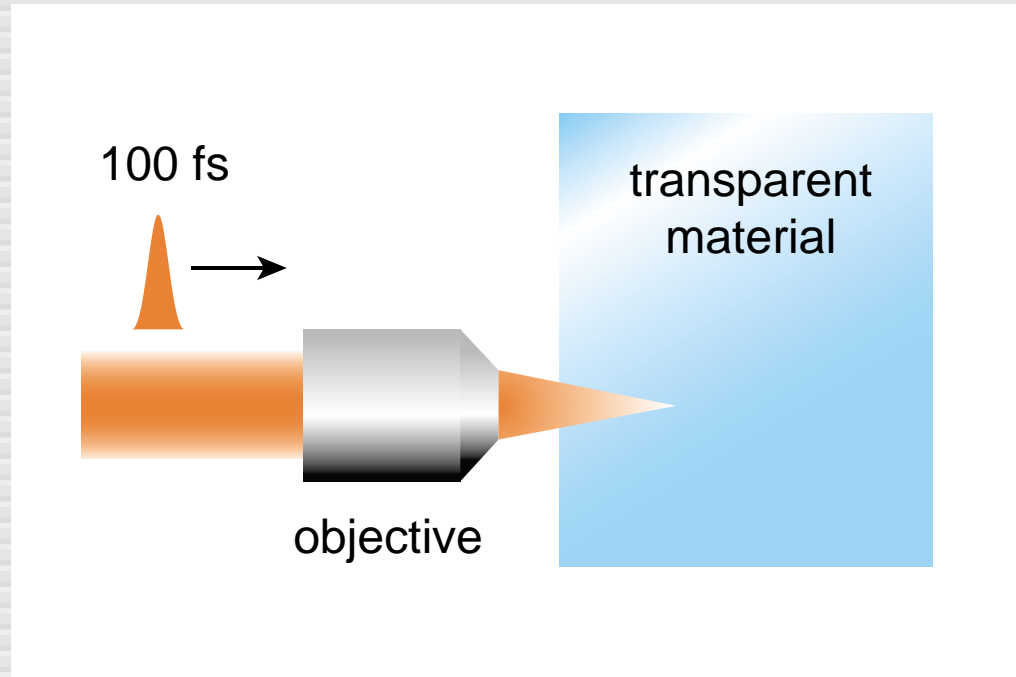

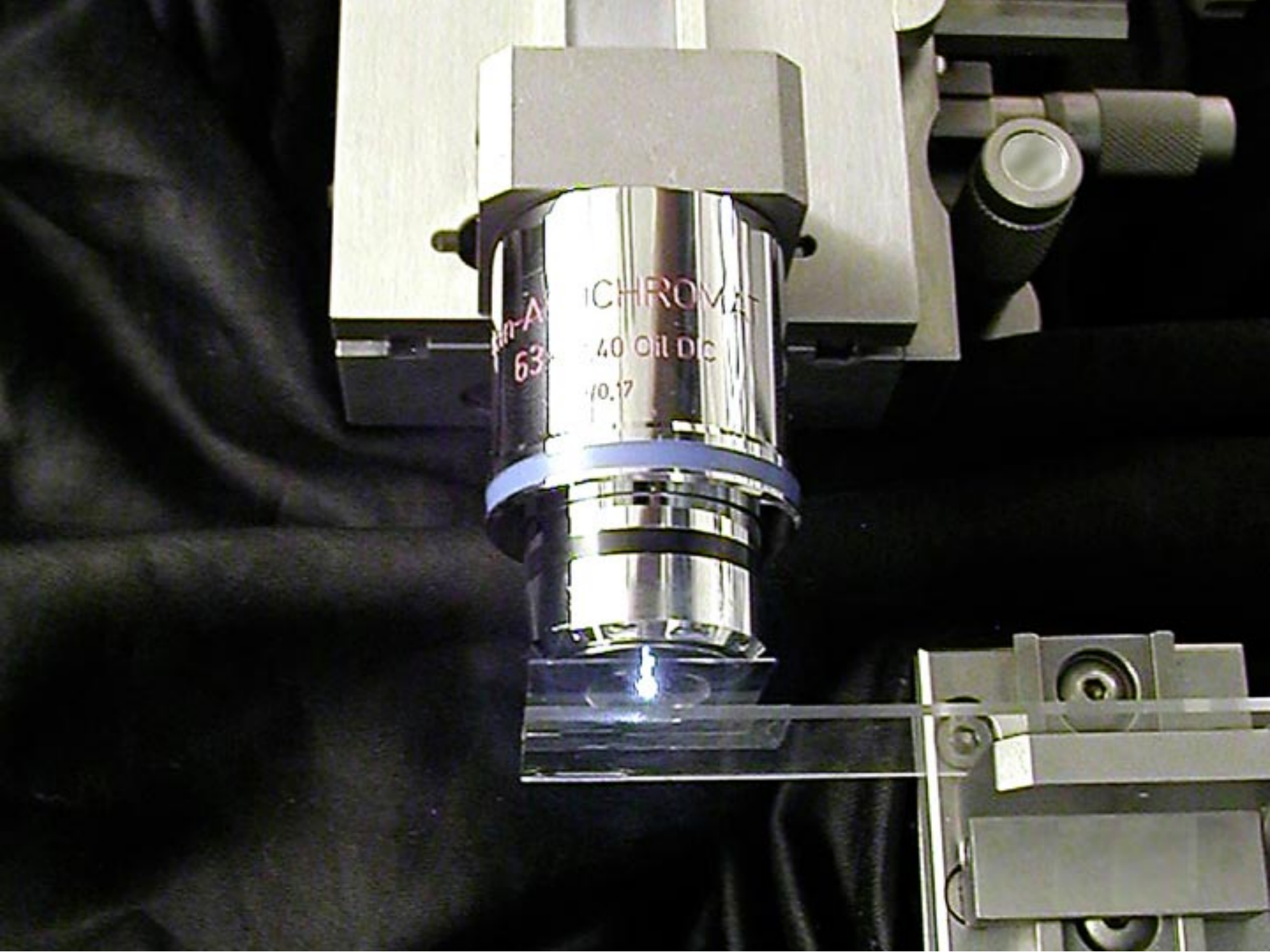

Mikro-A
63x
ACHROMAT
40 Oil DC
10.17

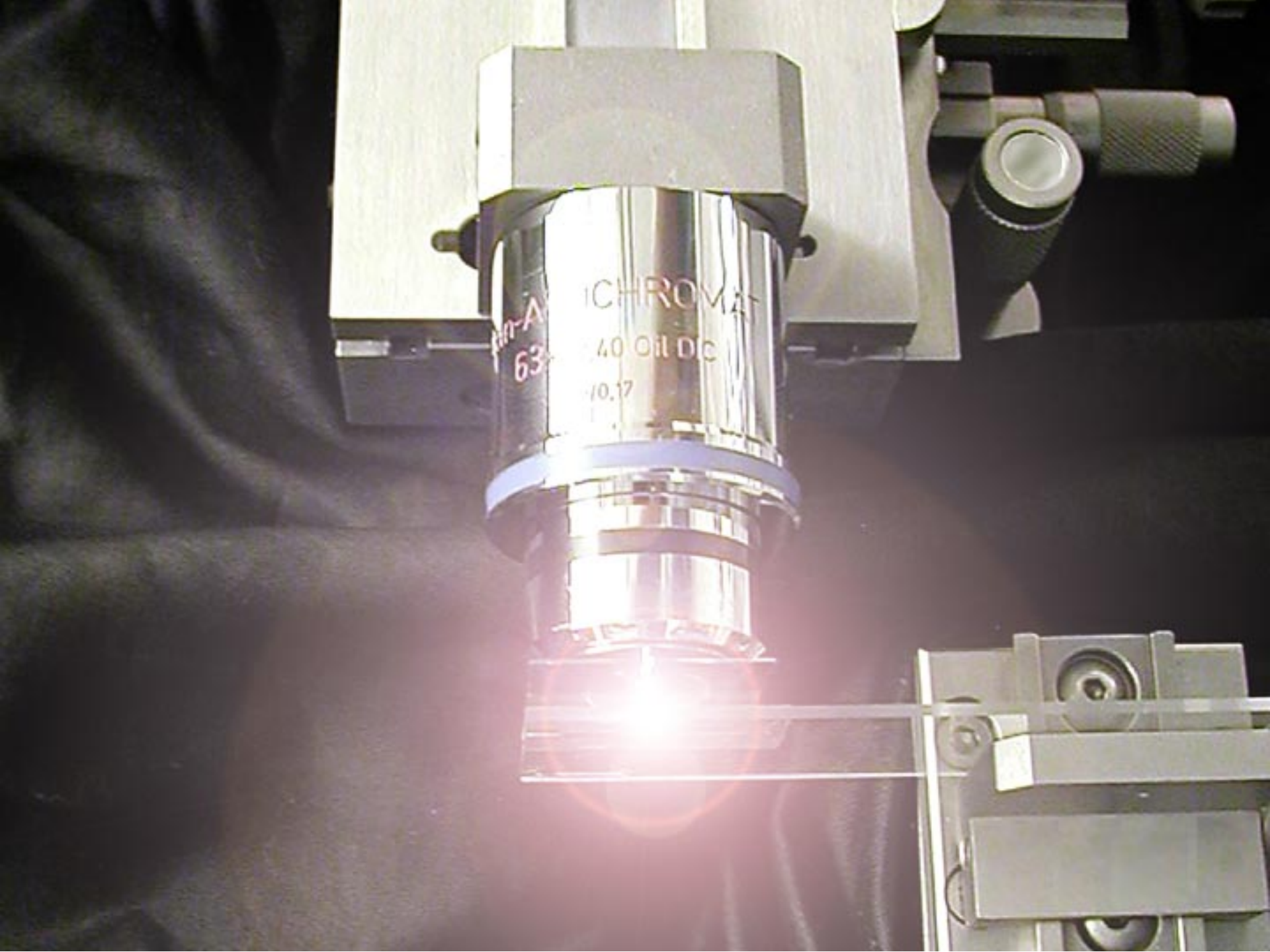

10x-A
63

ACHROMAT
40 Oil DC
10.17

Processing with fs pulses

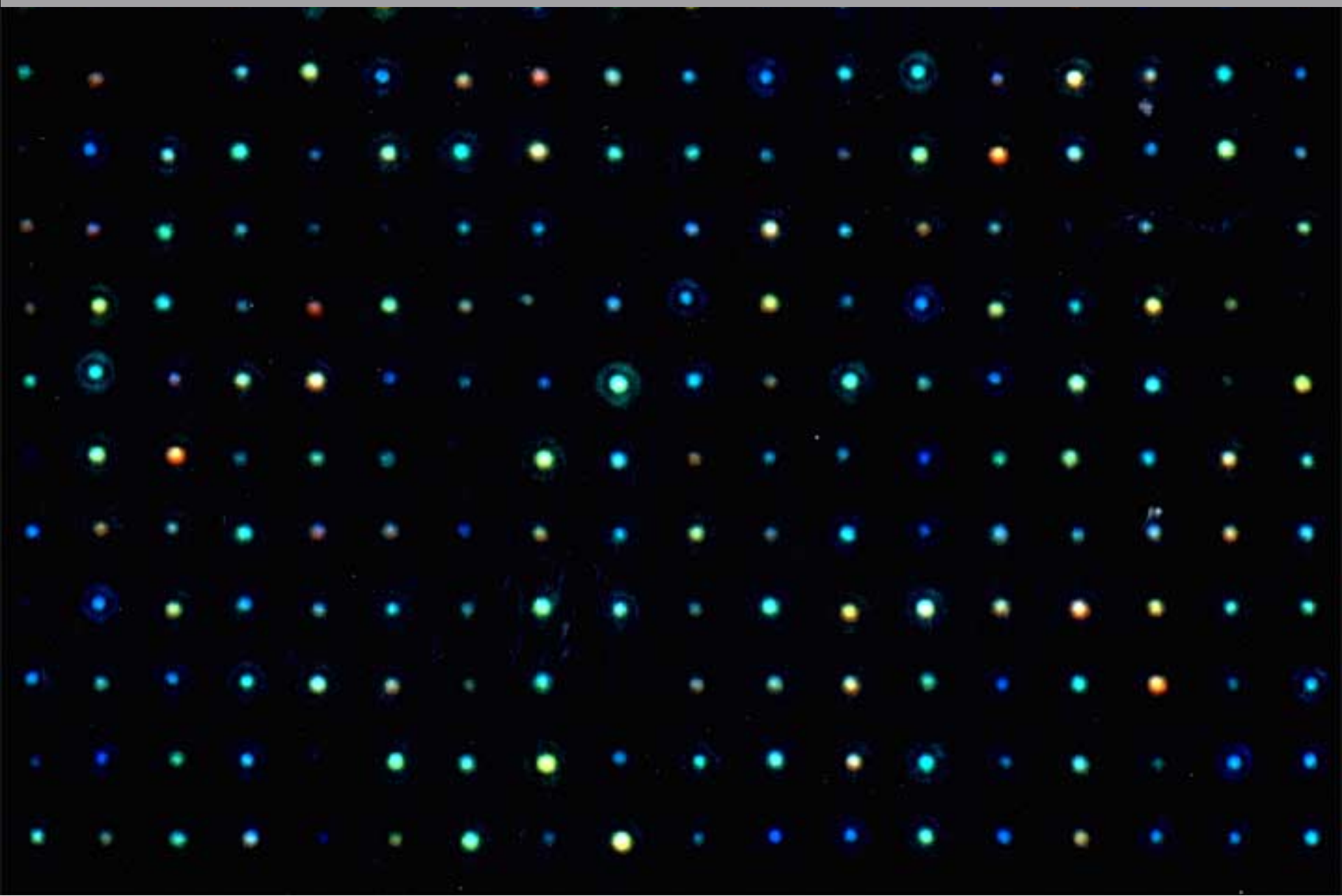

Processing with fs pulses

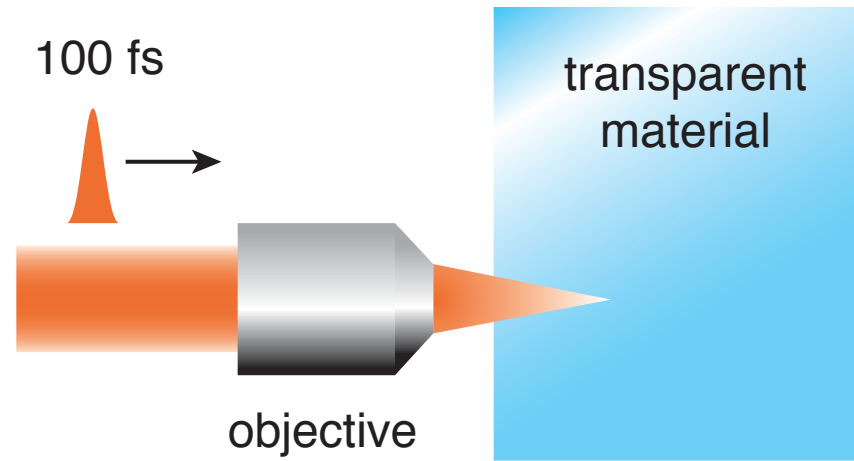

high intensity at focus...

Processing with fs pulses

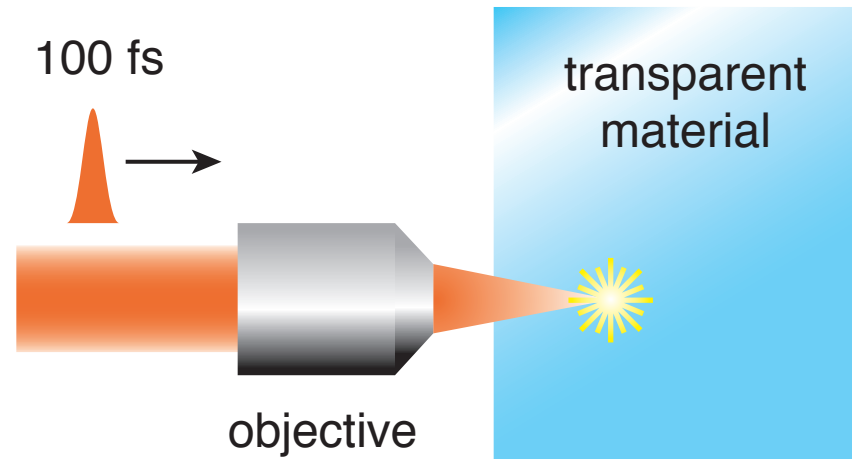

...causes nonlinear ionization...

Processing with fs pulses

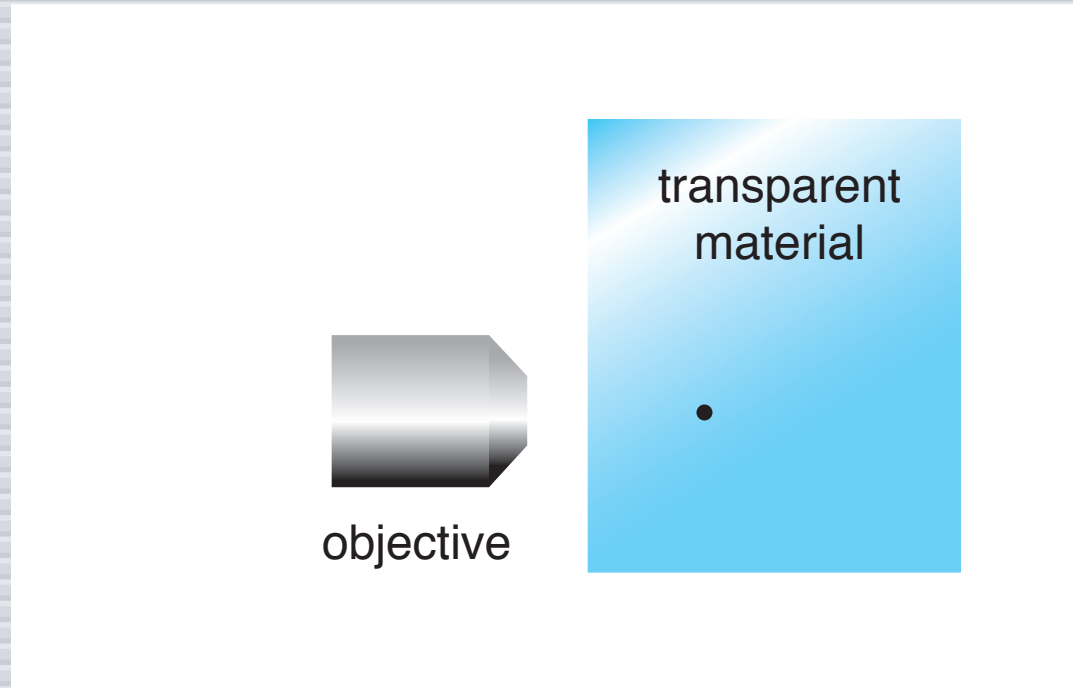

and 'microexplosion' causes microscopic damage

Processing with fs pulses

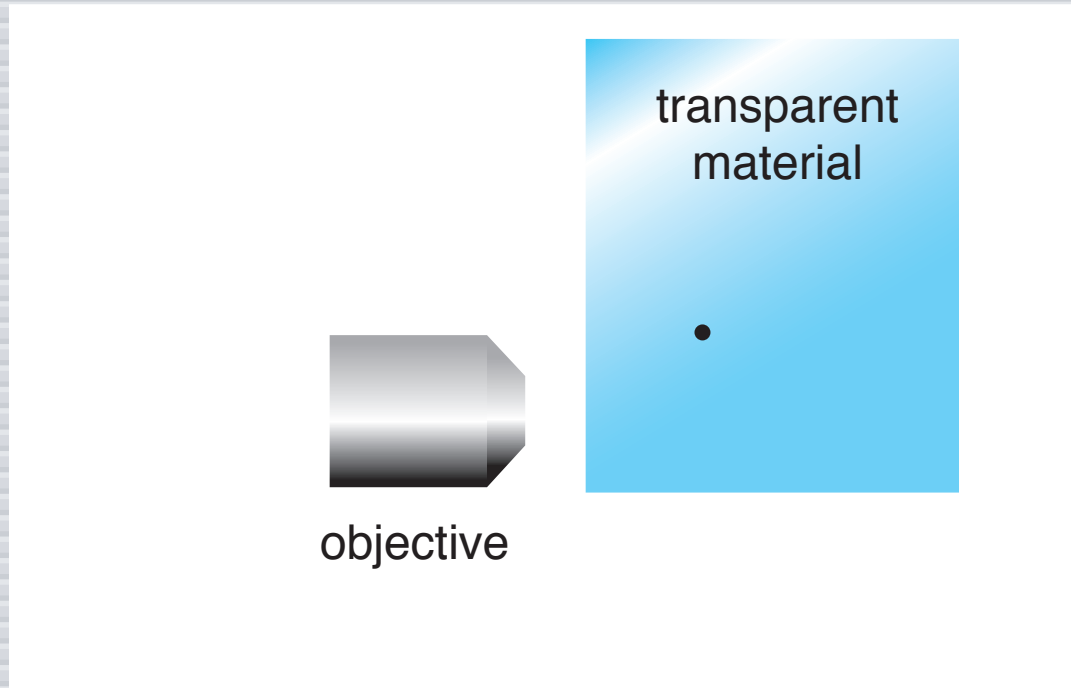

translate sample

Processing with fs pulses

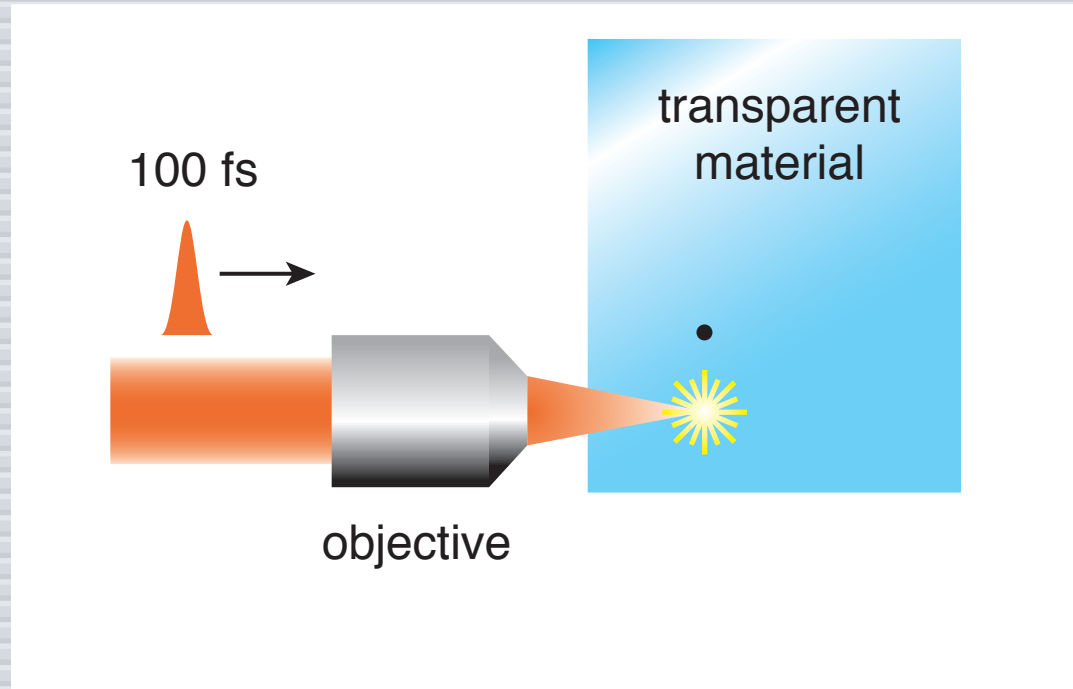

100 fs: laser energy transferred to electrons

Processing with fs pulses

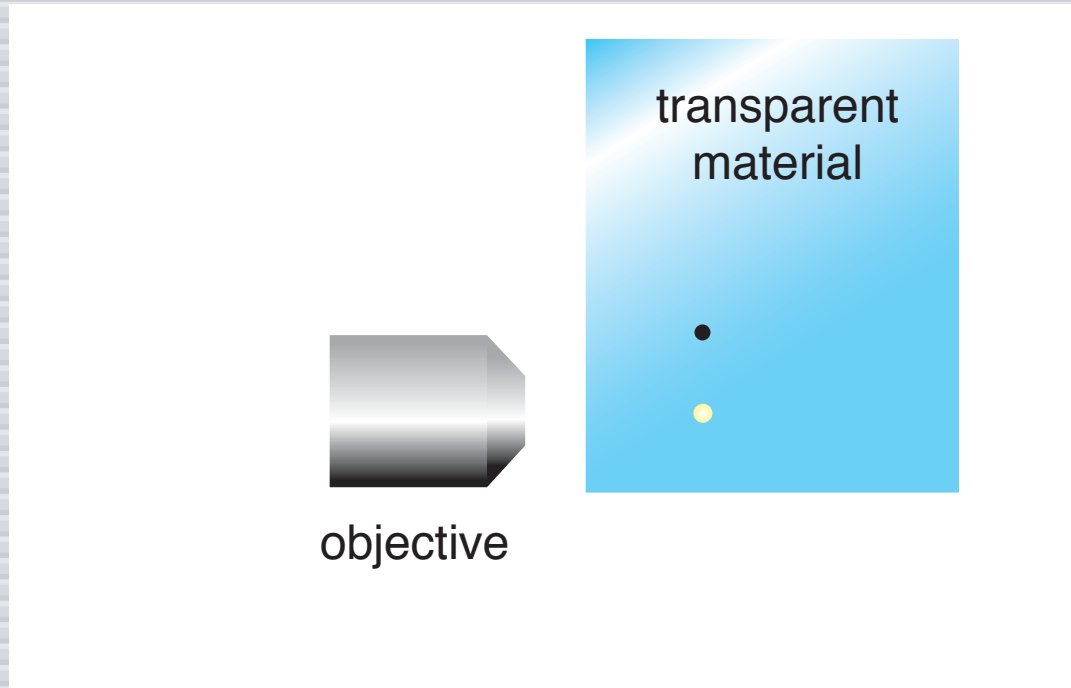

10 ps: energy transfer to ions

Processing with fs pulses

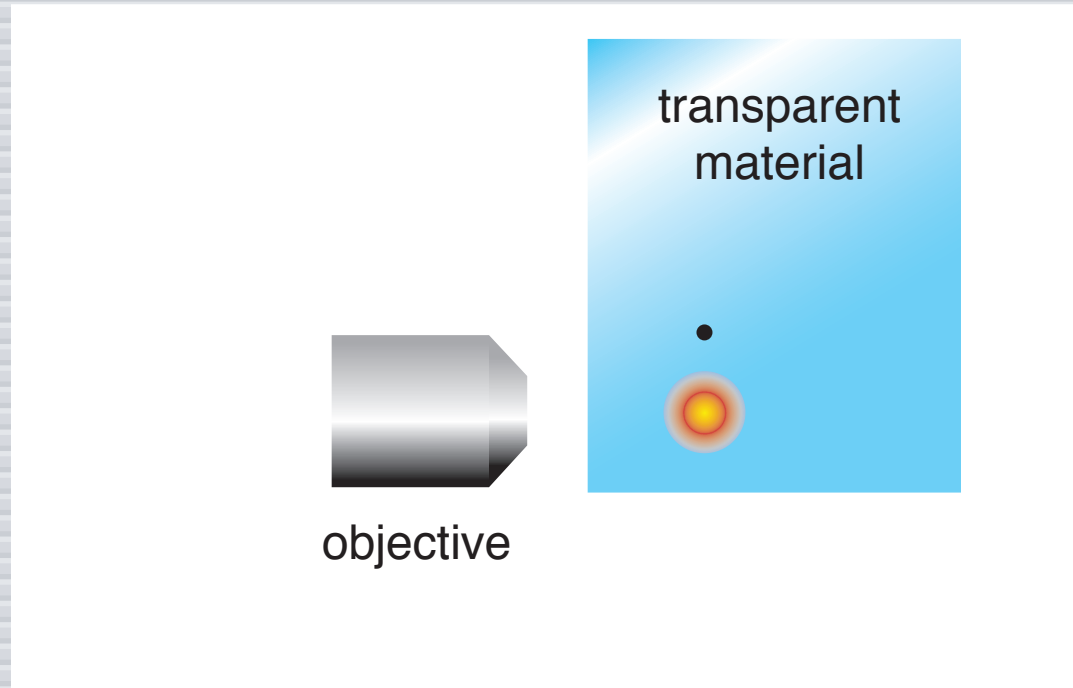

100 ps: plasma expansion

Processing with fs pulses

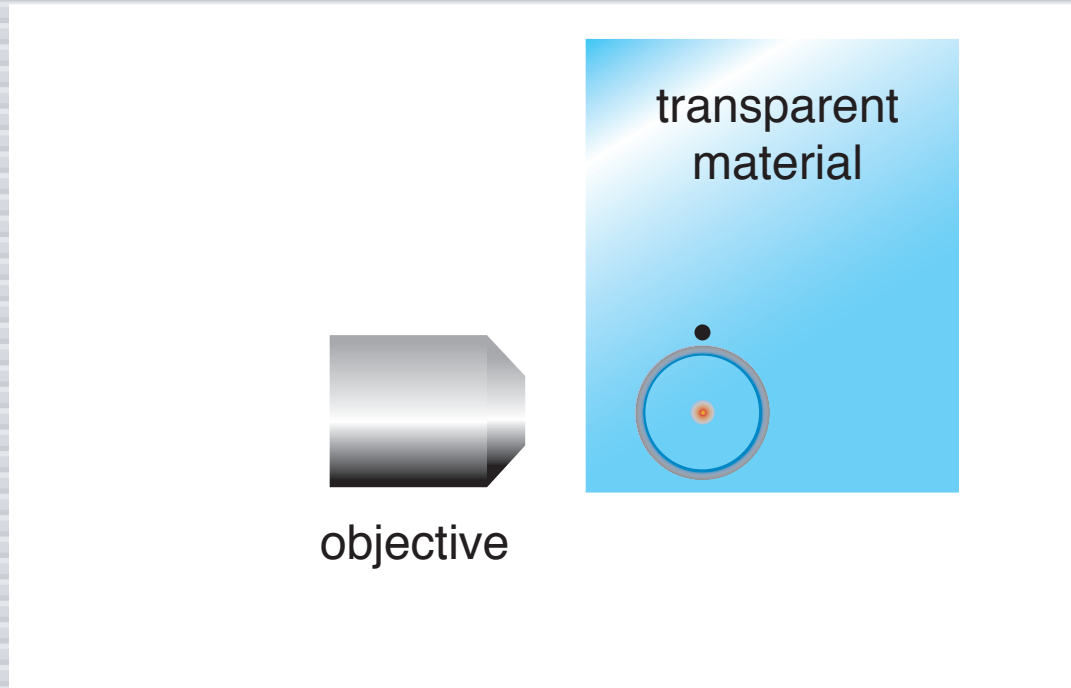

10–100 ns: shock propagation

Processing with fs pulses

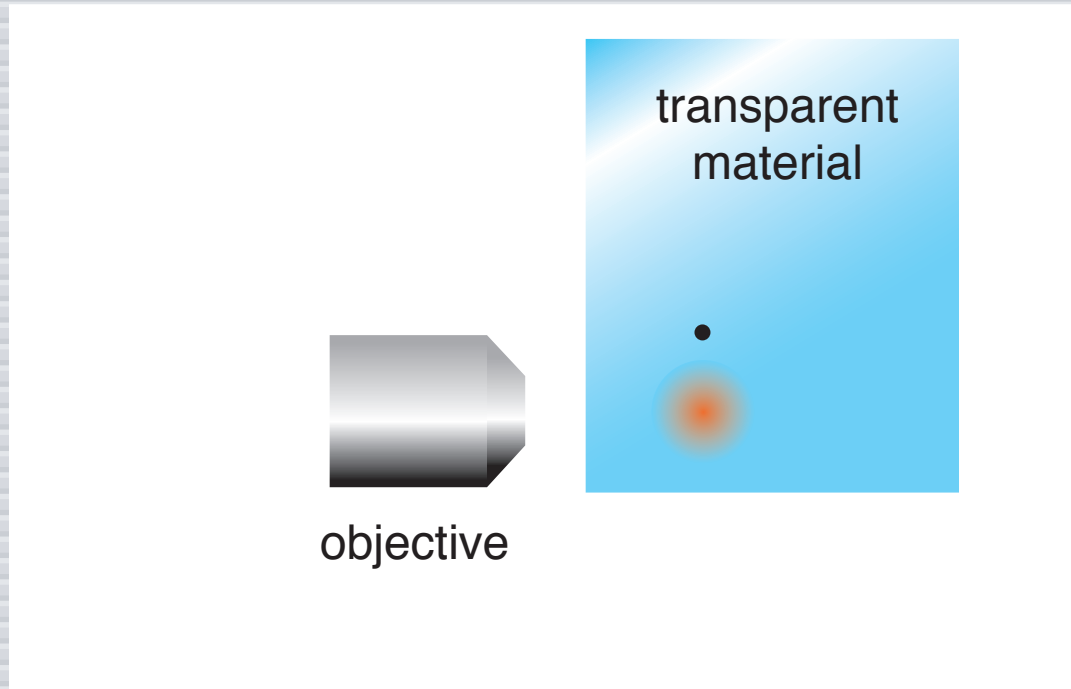

1 μ s: thermal expansion

Processing with fs pulses

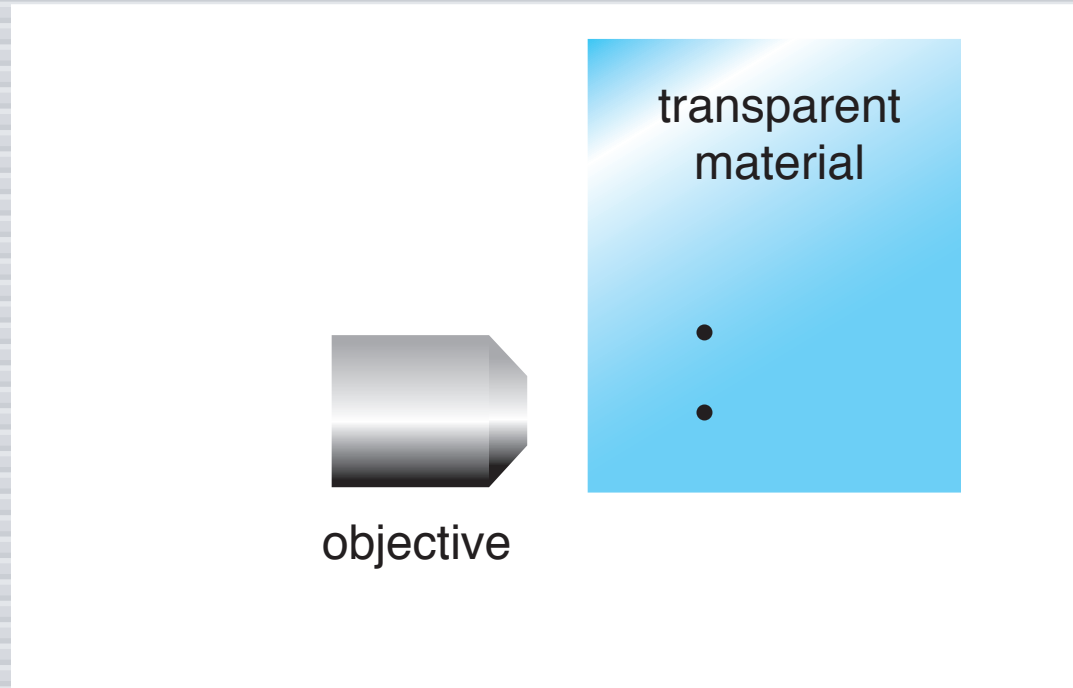

1 ms: permanent structural damage

Processing with fs pulses

2 x 2 μm array

fused silica, 0.65 NA

0.5 μJ , 100 fs, 800 nm

***Opt. Lett.* 21, 2023 (1996)**

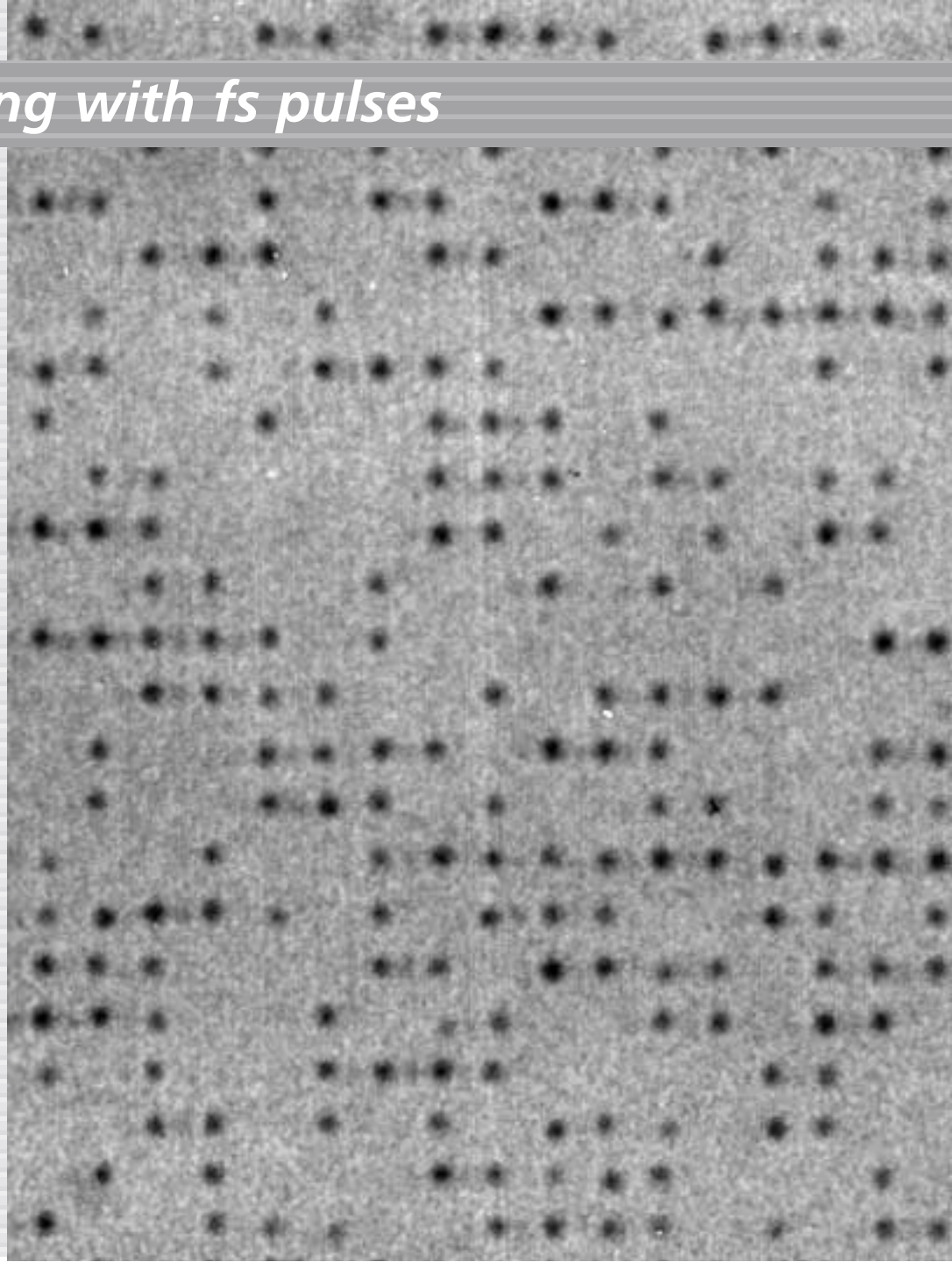

Processing with fs pulses

2 x 2 μm array

fused silica, 0.65 NA

0.5 μJ , 100 fs, 800 nm

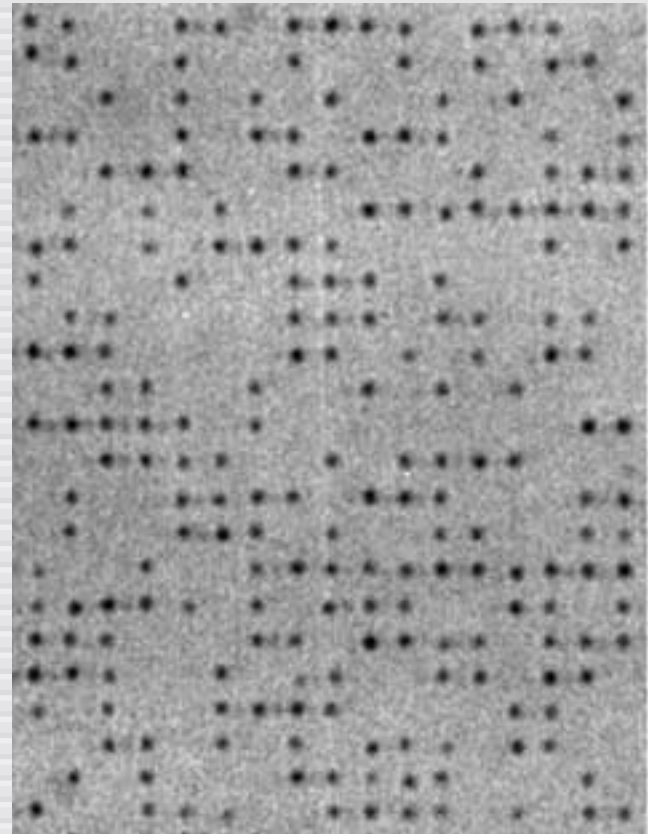

Processing with fs pulses

2 x 2 μm array

fused silica, 0.65 NA

0.5 μJ , 100 fs, 800 nm

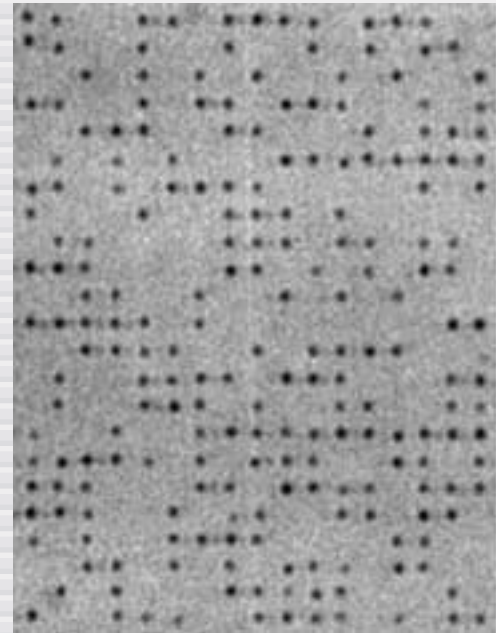

Processing with fs pulses

2 x 2 μm array

fused silica, 0.65 NA

0.5 μJ , 100 fs, 800 nm

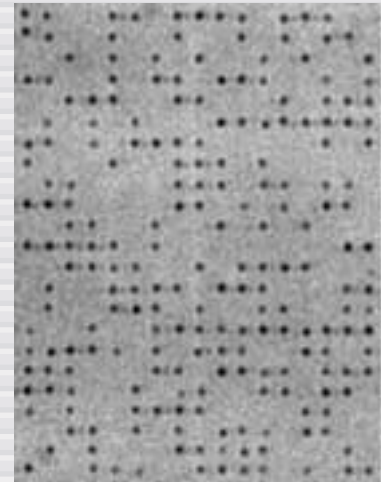

Processing with fs pulses

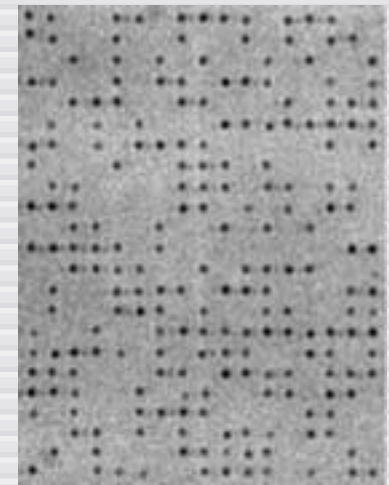

100 fs
0.5 μ J

200 ps
9 μ J

Processing with fs pulses

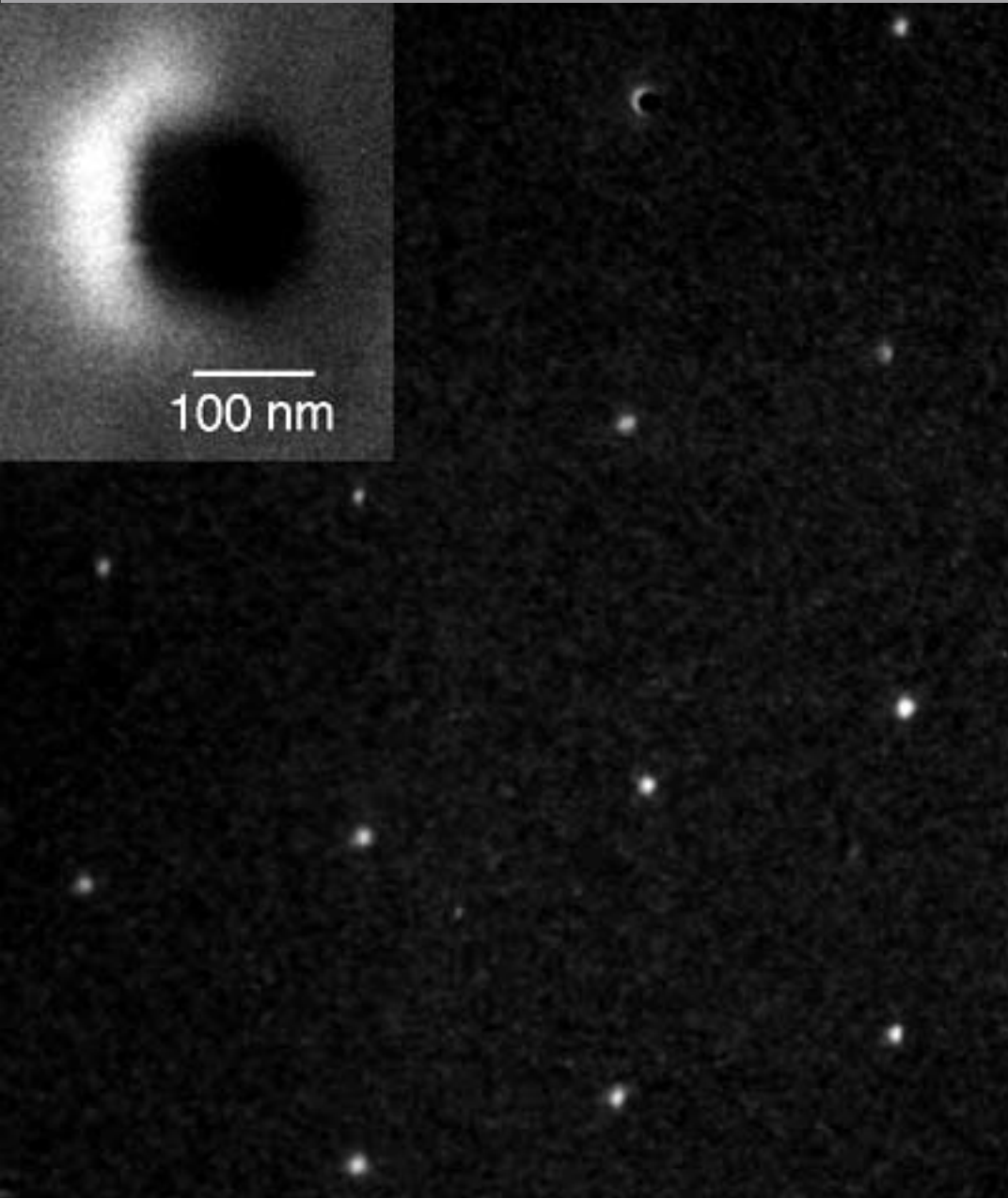

5 x 5 μm array

fused silica, 0.65 NA

0.5 μJ , 100 fs, 800 nm

Opt. Lett. 21, 2023 (1996)

Processing with fs pulses

Points to keep in mind:

- ▶ **fs laser processing works**
- ▶ **focusing very important**
- ▶ **no collateral damage**

Outline

- ▶ Processing with fs pulses
- ▶ Role of focusing
- ▶ Low-energy processing

Role of focusing

Dark-field scattering

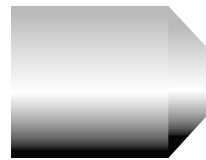

objective



sample

Role of focusing

block probe beam...

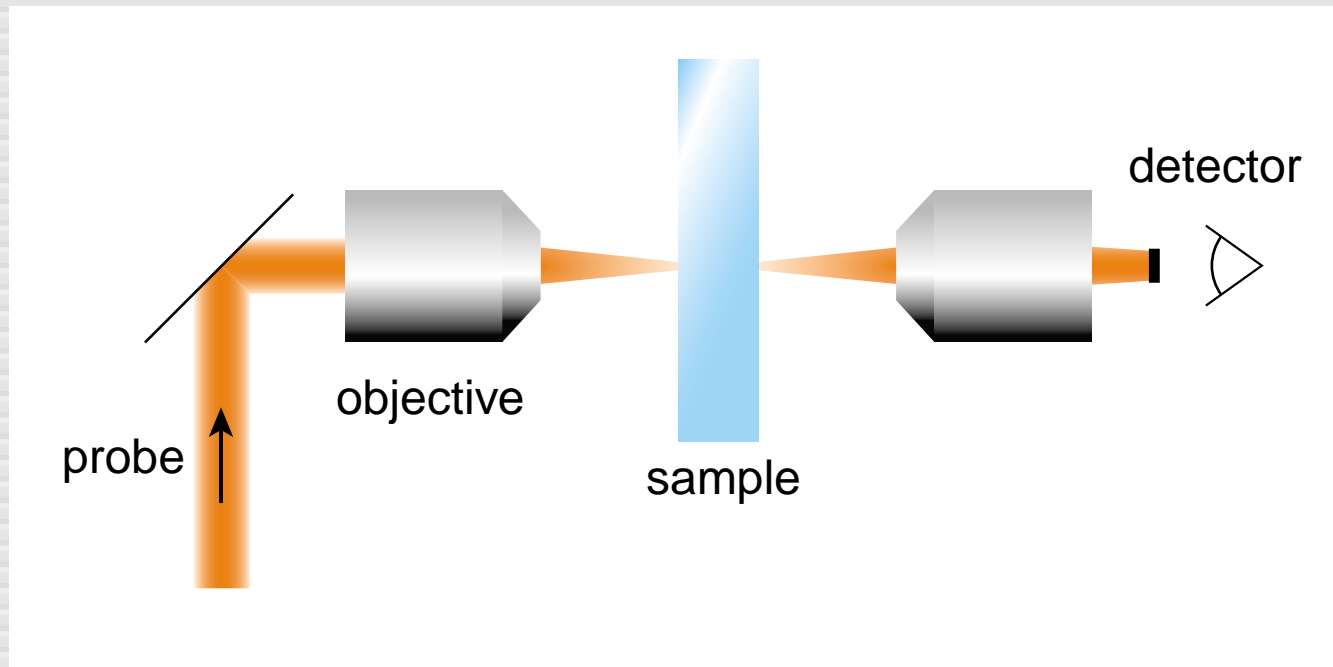

Role of focusing

... bring in pump beam...

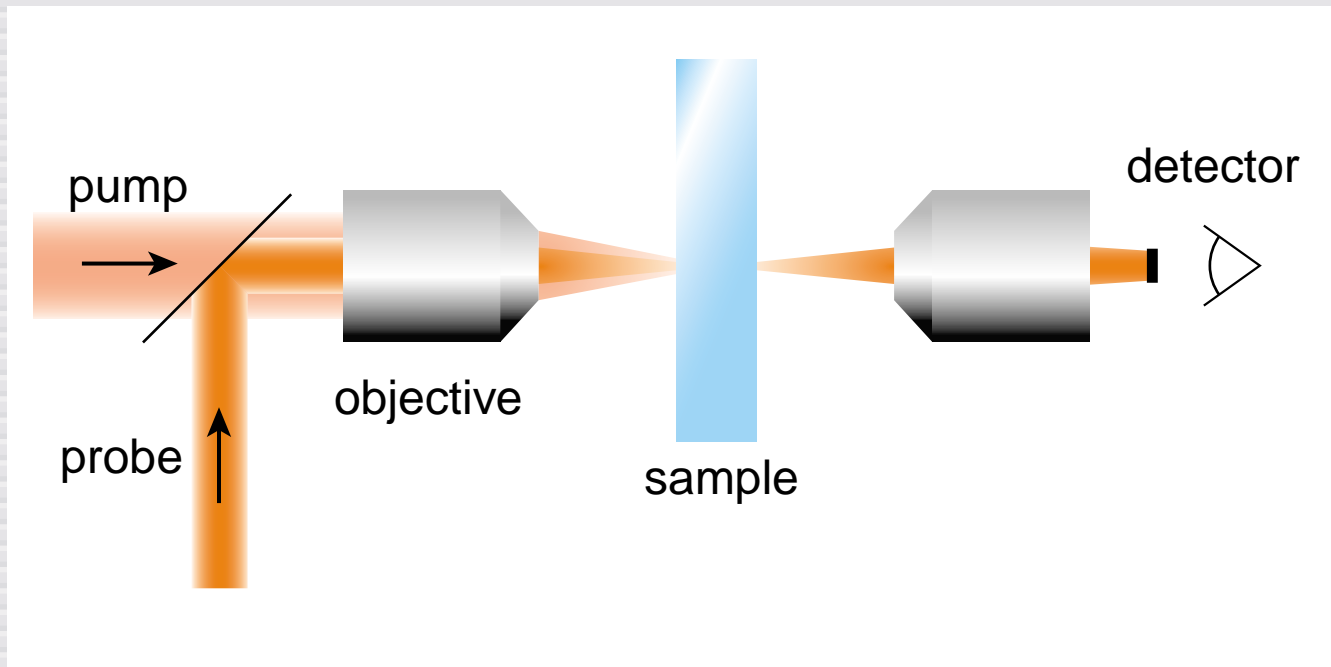

Role of focusing

... damage scatters probe beam

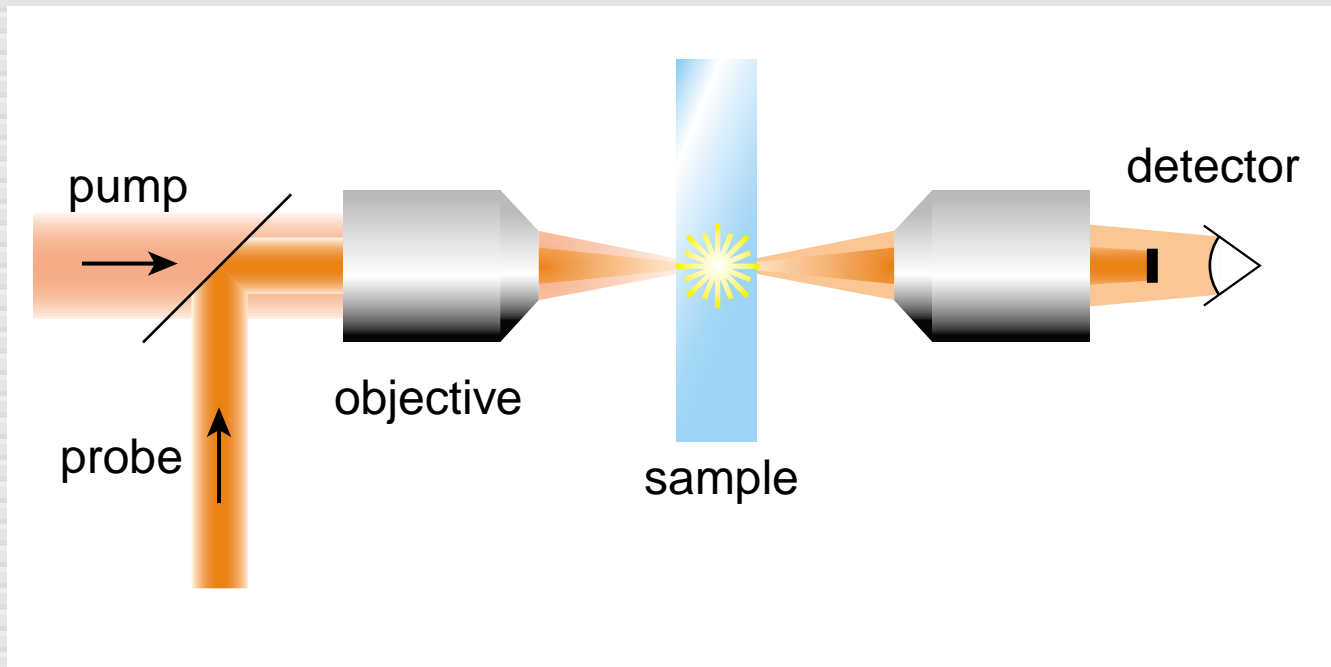

Role of focusing

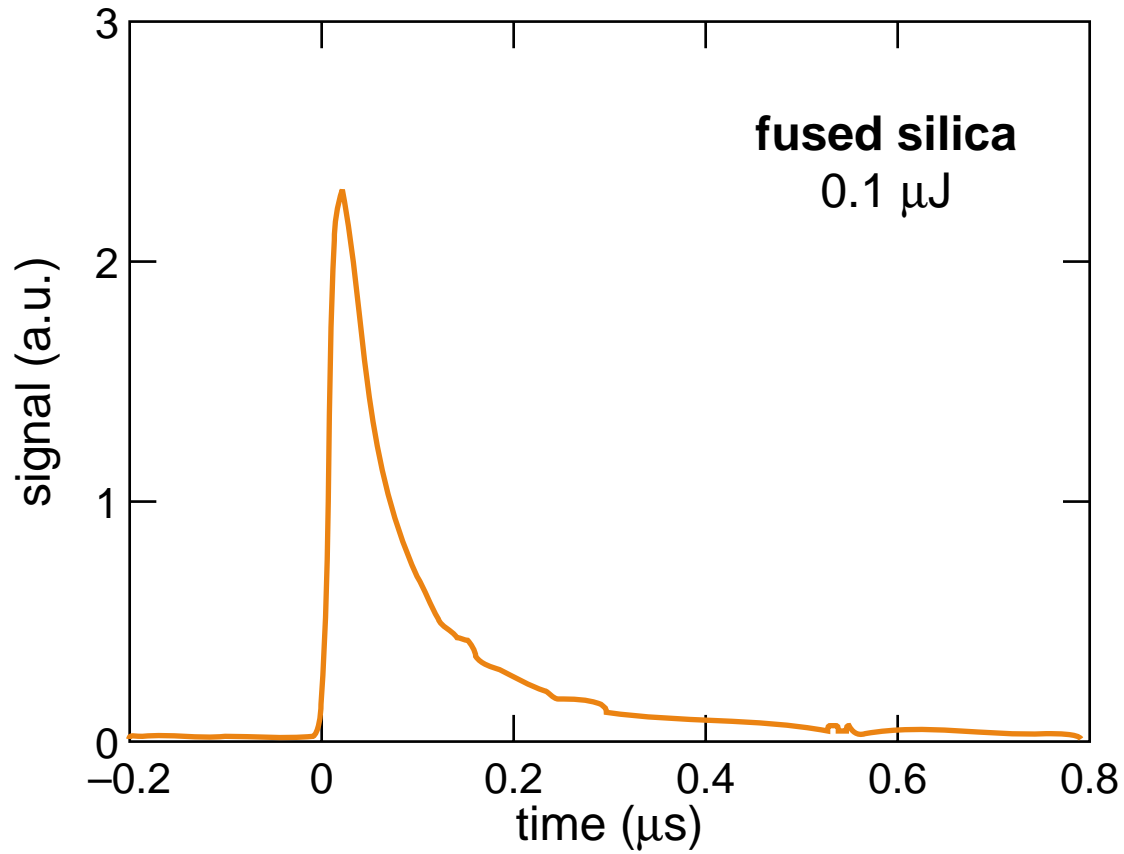

Role of focusing

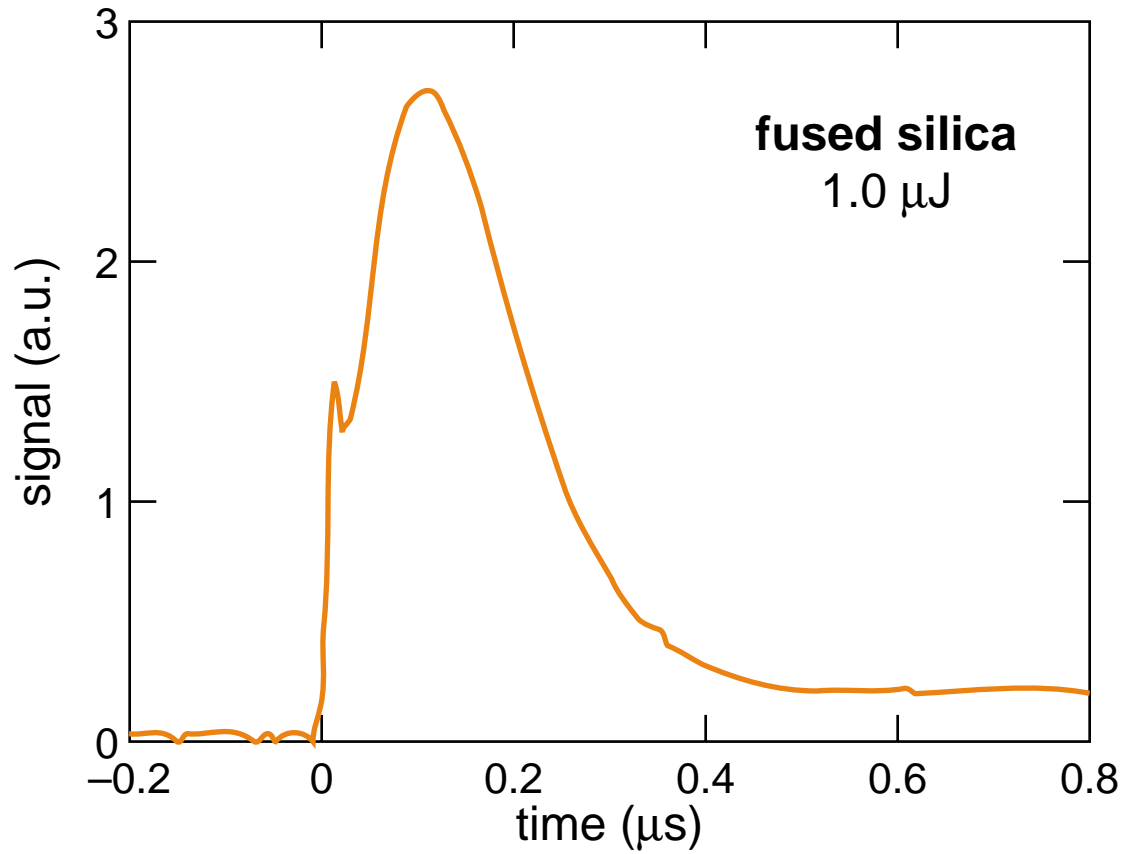

Role of focusing

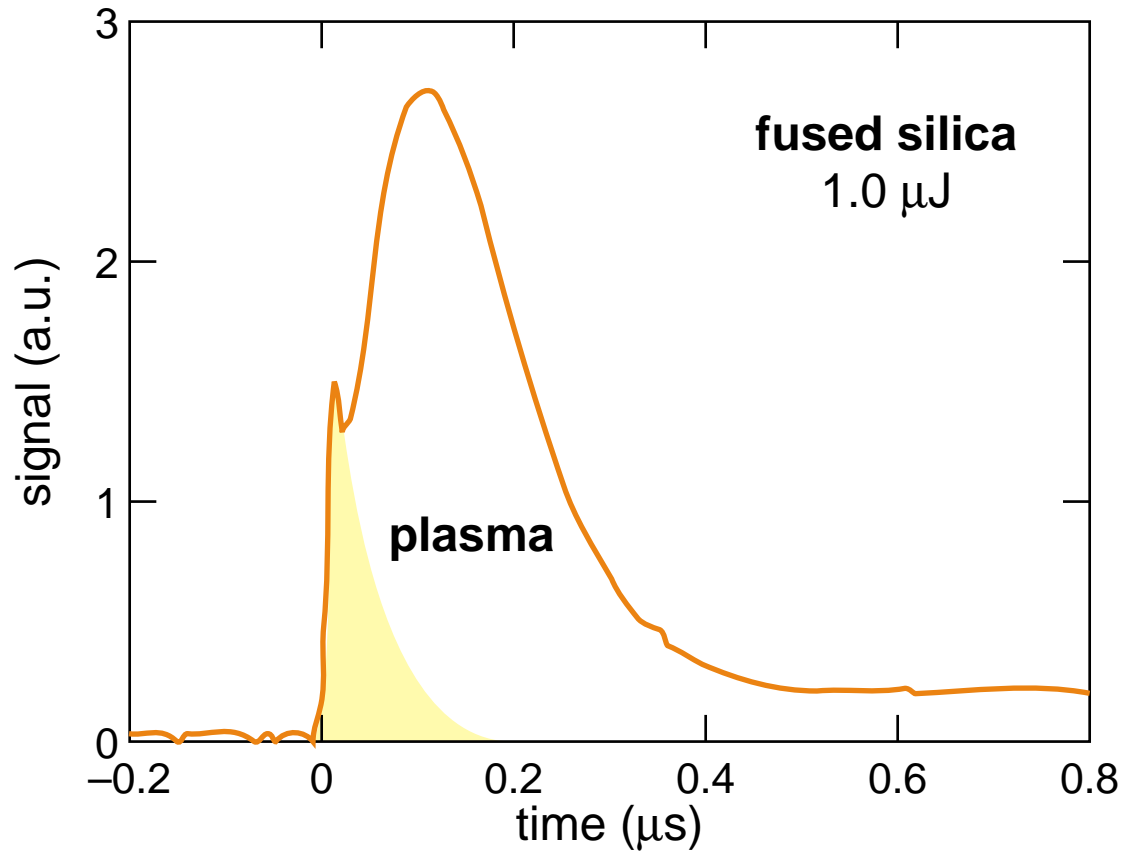

Role of focusing

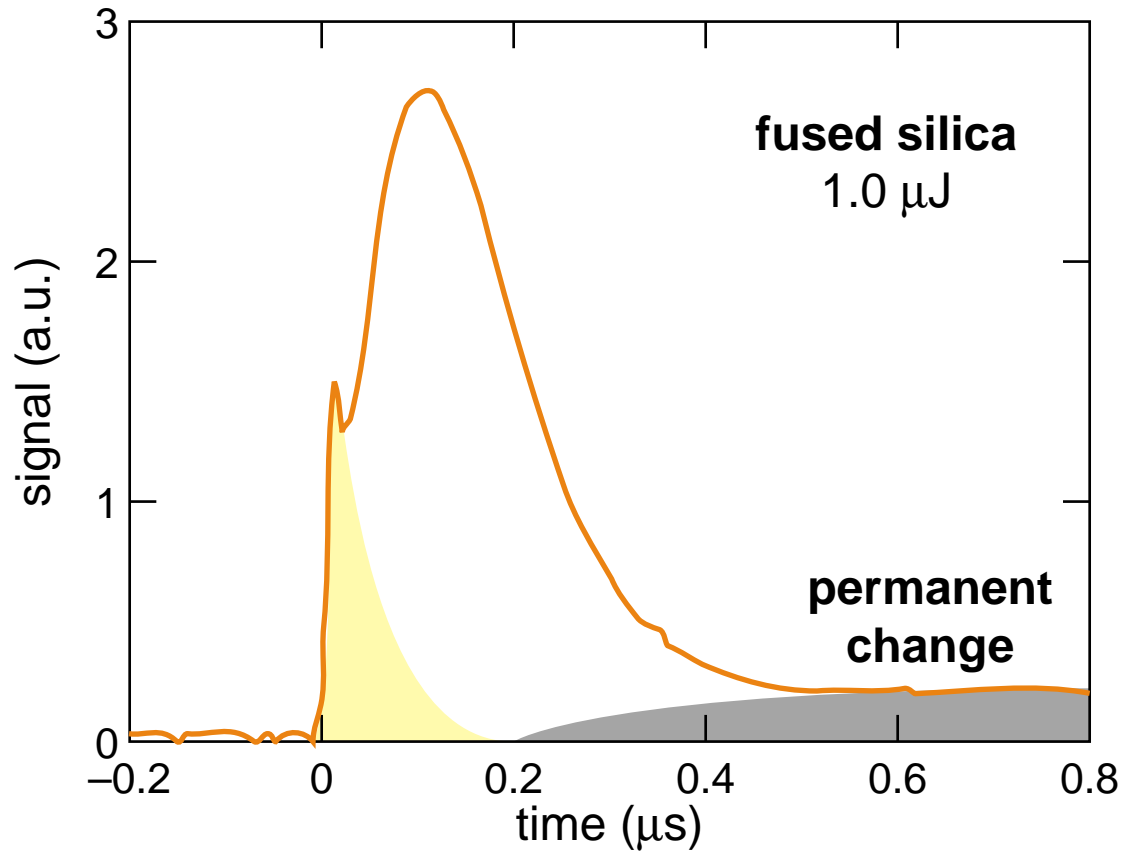

Role of focusing

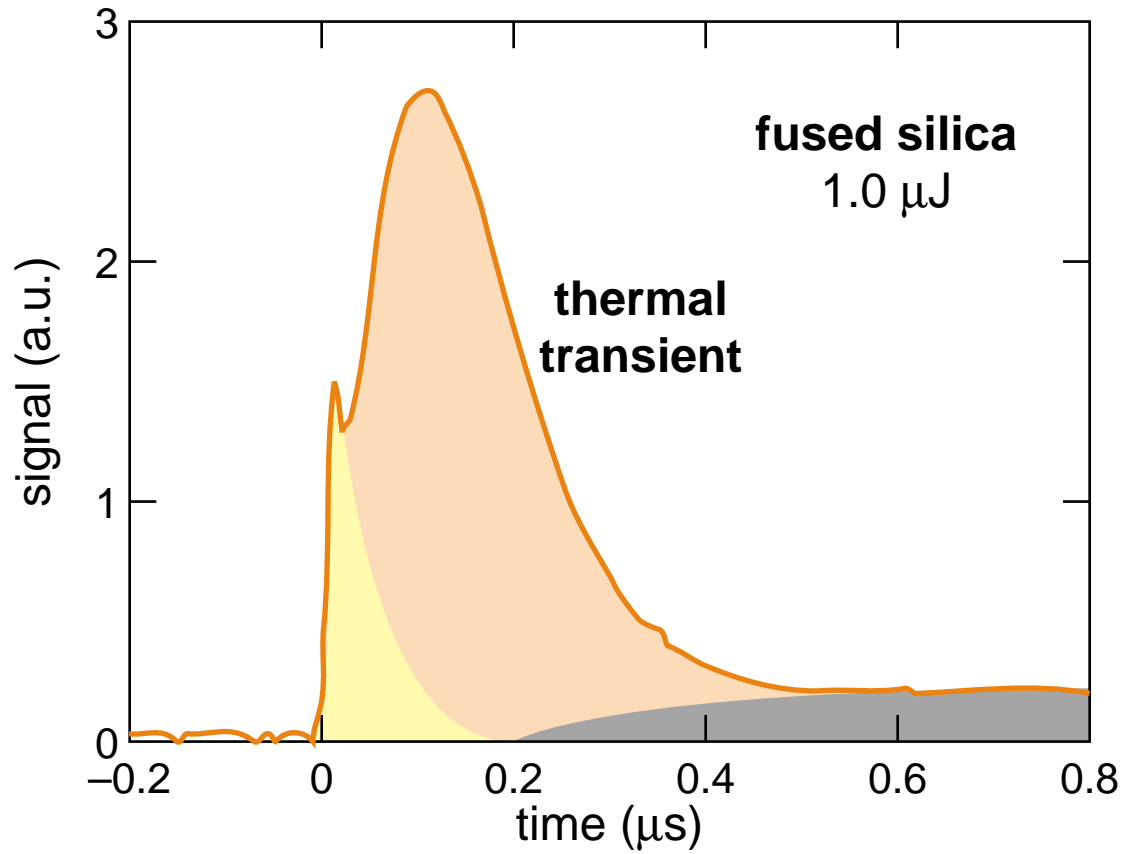

Role of focusing

vary numerical aperture in Corning 0211

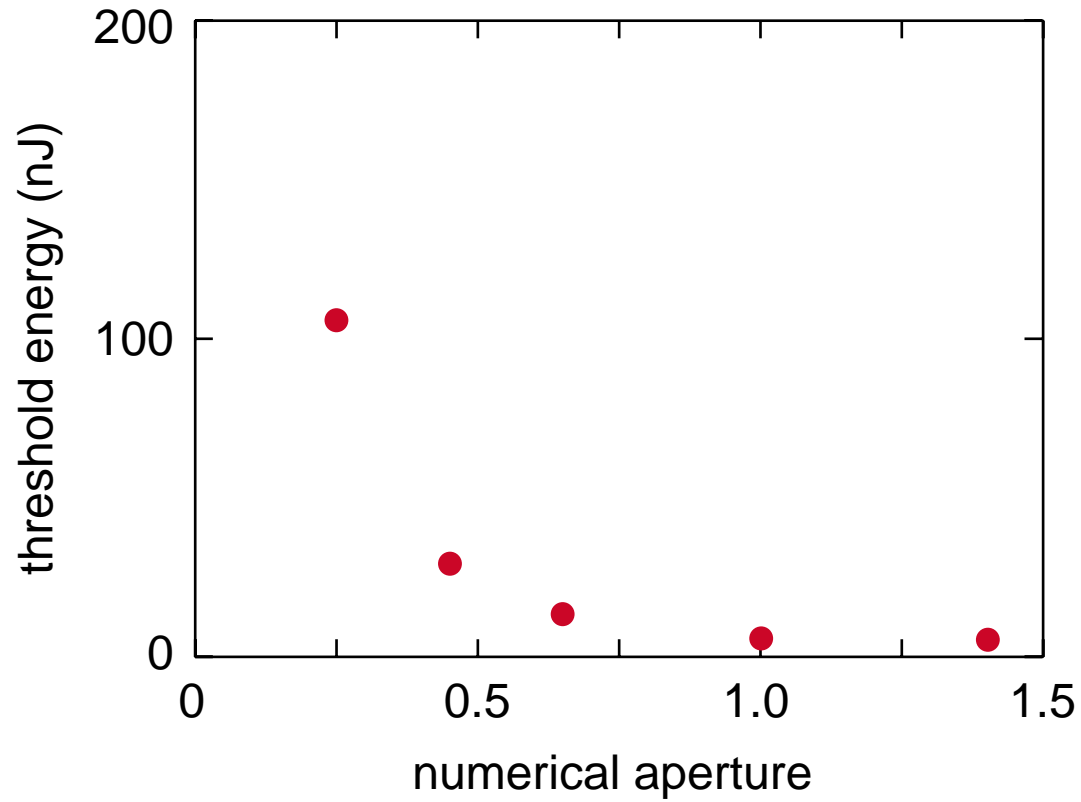

Role of focusing

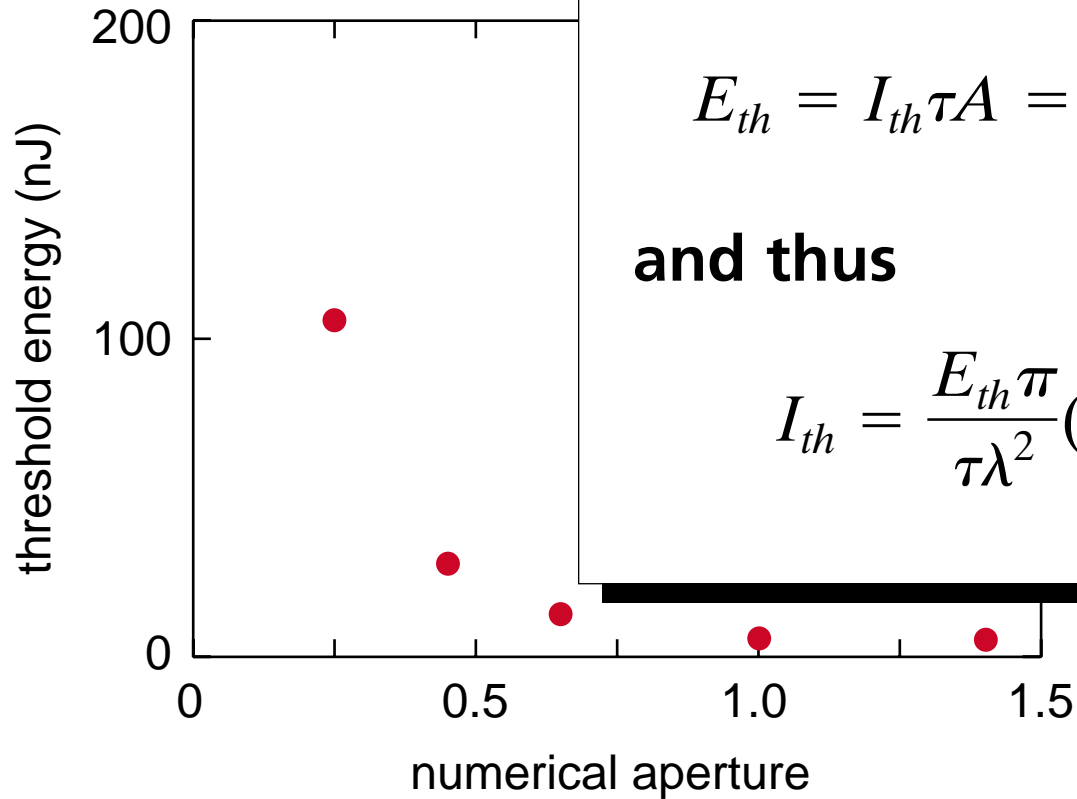

**spot size determined by
numerical aperture:**

$$E_{th} = I_{th} \tau A = \frac{I_{th} \tau \lambda^2}{\pi (\text{NA})^2}$$

and thus

$$I_{th} = \frac{E_{th} \pi}{\tau \lambda^2} (\text{NA})^2$$

Role of focusing

fit gives threshold intensity: $I_{th} = 2.5 \times 10^{17} \text{ W/m}^2$

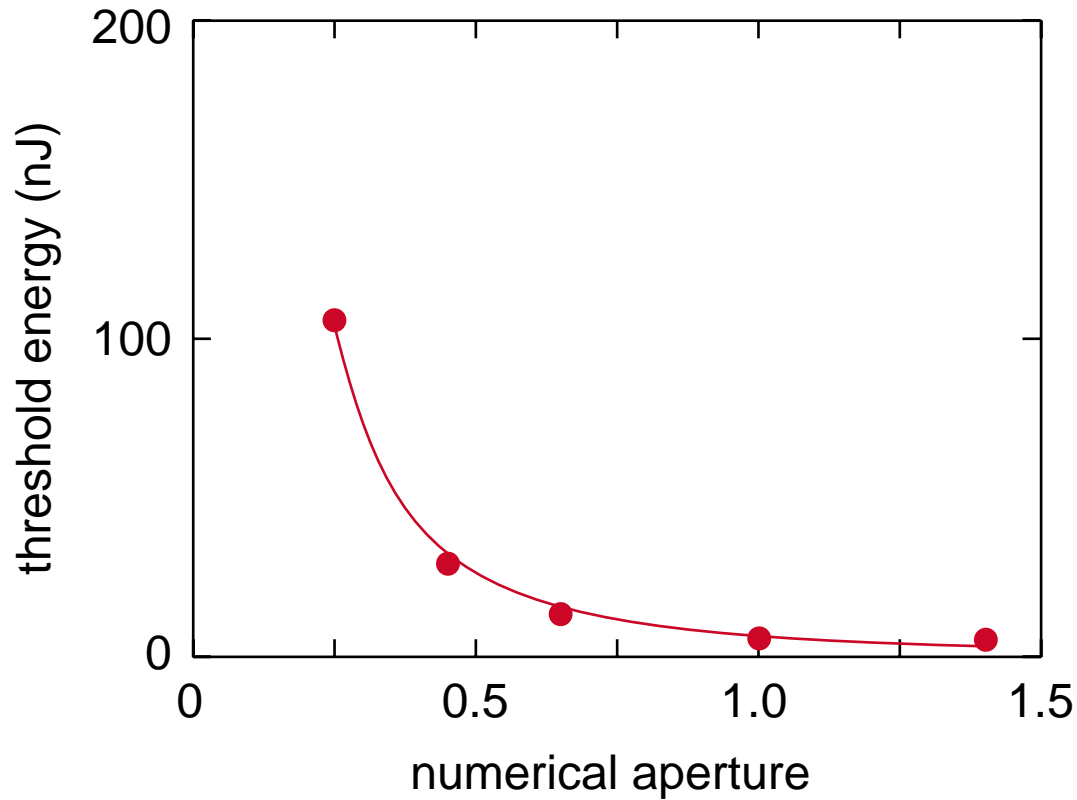

Role of focusing

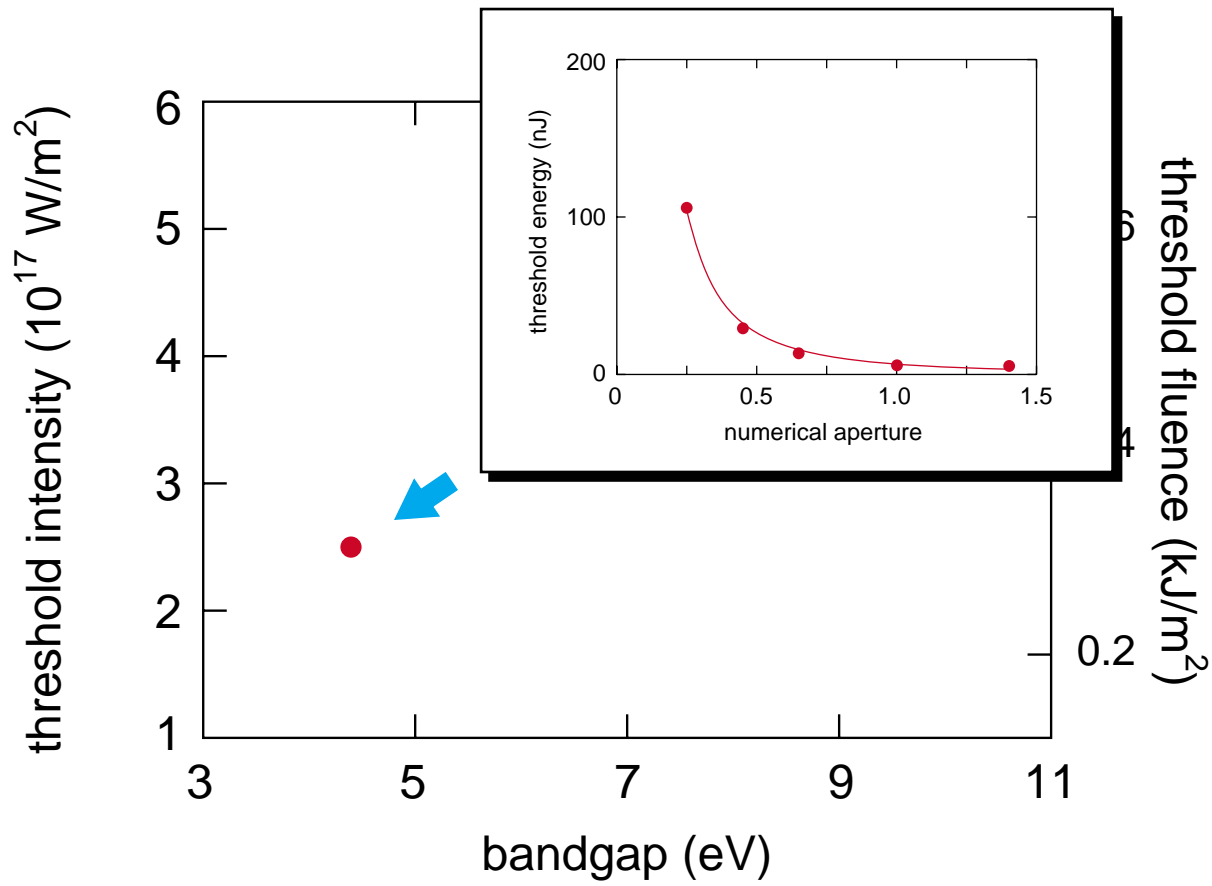

Role of focusing

vary material...

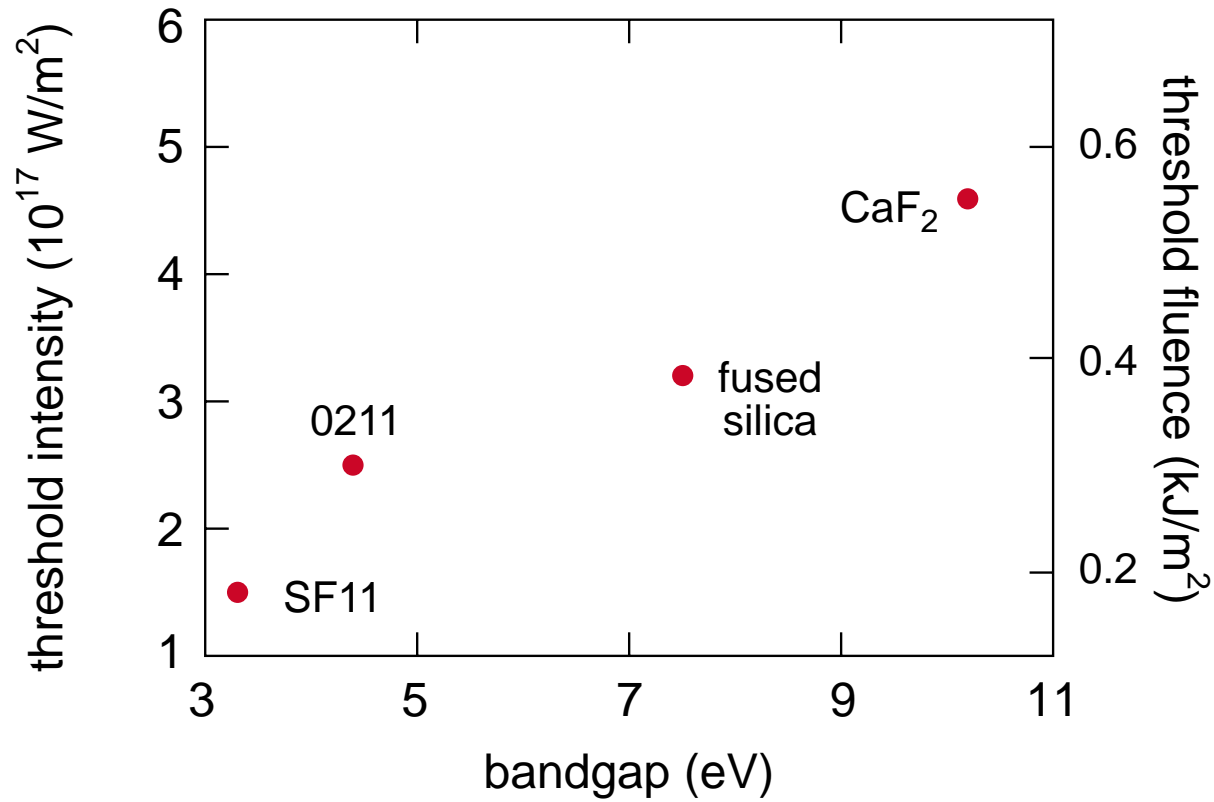

Role of focusing

threshold varies with bandgap

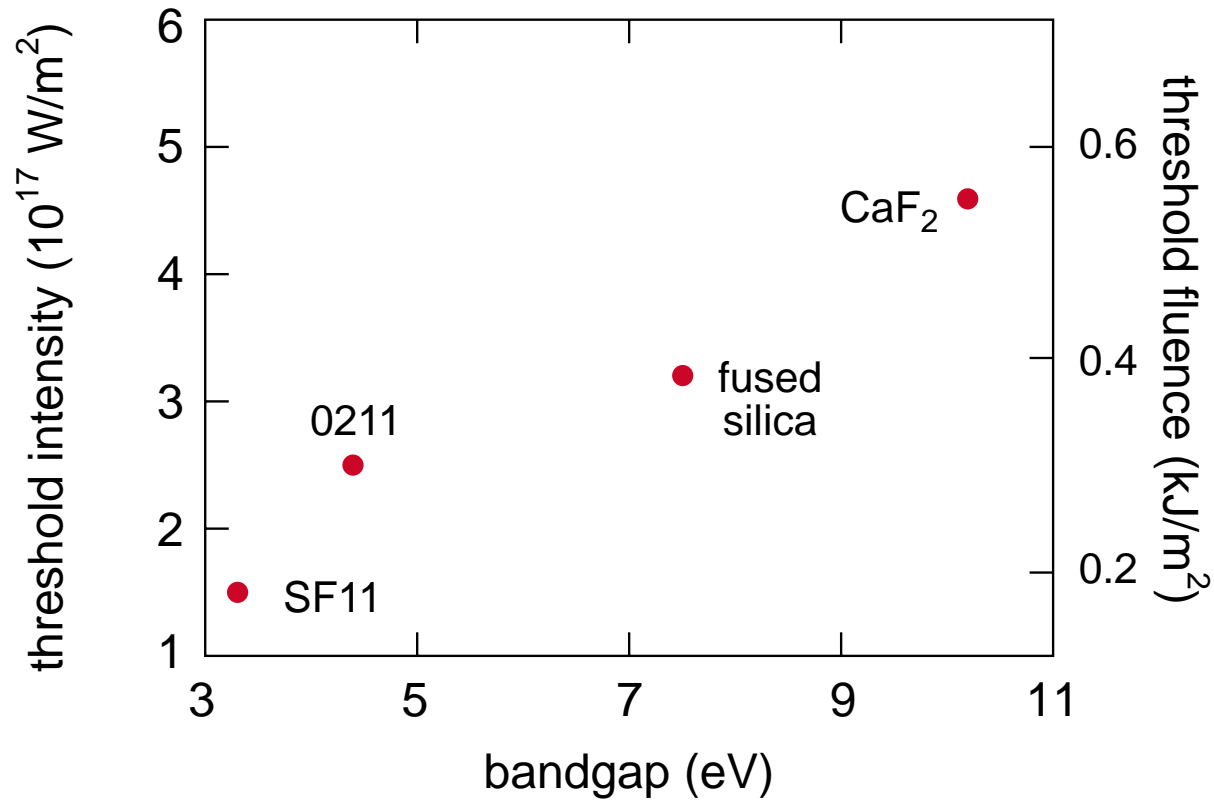

Role of focusing

Points to keep in mind:

- ▶ **threshold critically dependent on NA**
- ▶ **surprisingly little material dependence**
- ▶ **avalanche ionization important**

Outline

- ▶ Processing with fs pulses
- ▶ Role of focusing
- ▶ **Low-energy processing**

Low-energy processing

threshold decreases with increasing numerical aperture

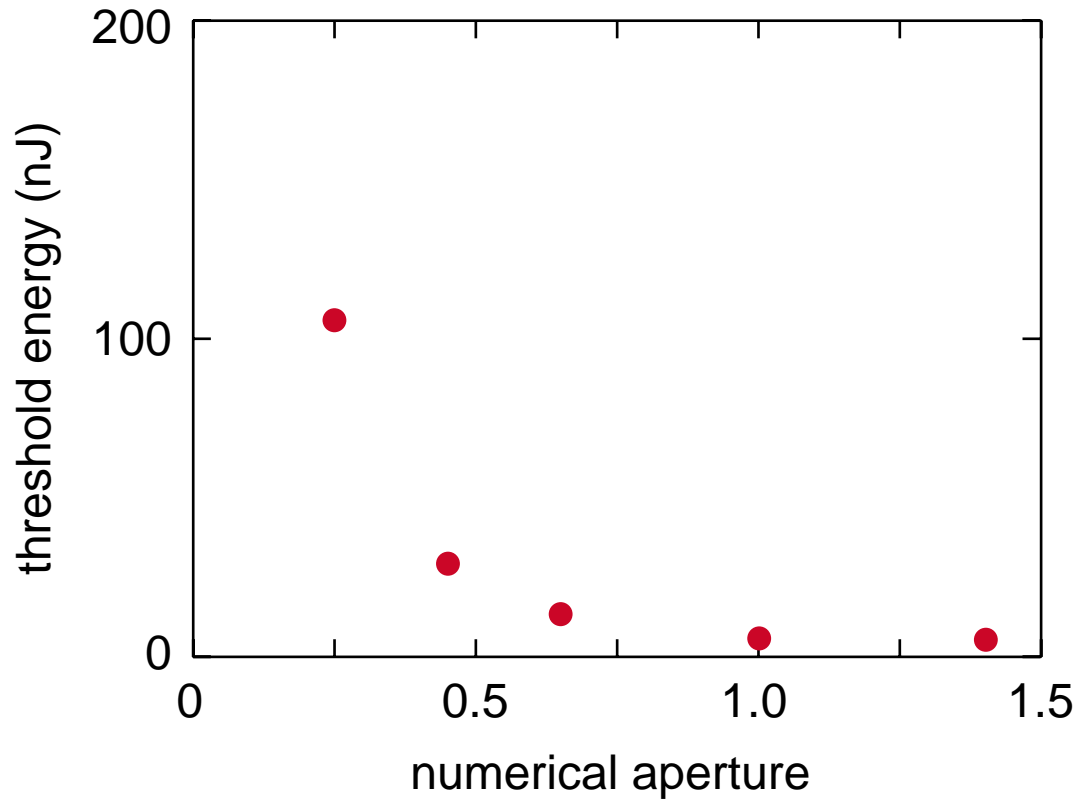

Low-energy processing

less than 10 nJ at high numerical aperture!

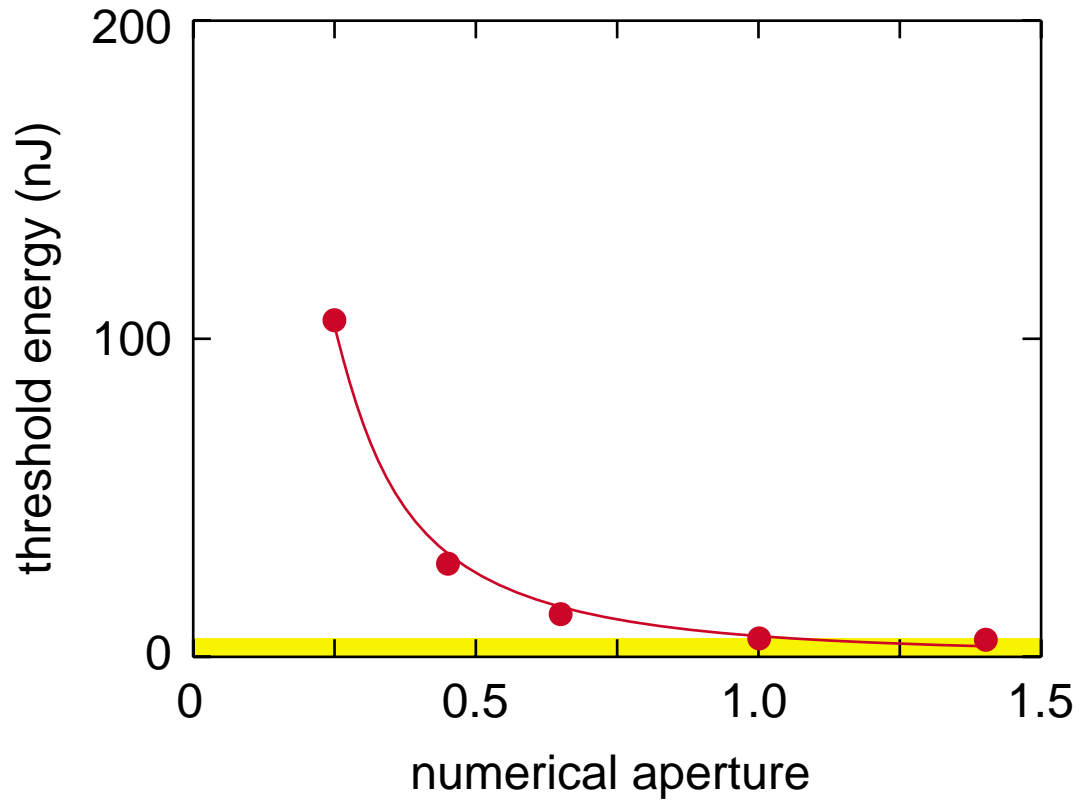

Low-energy processing

amplified laser: 1 kHz, 1 mJ

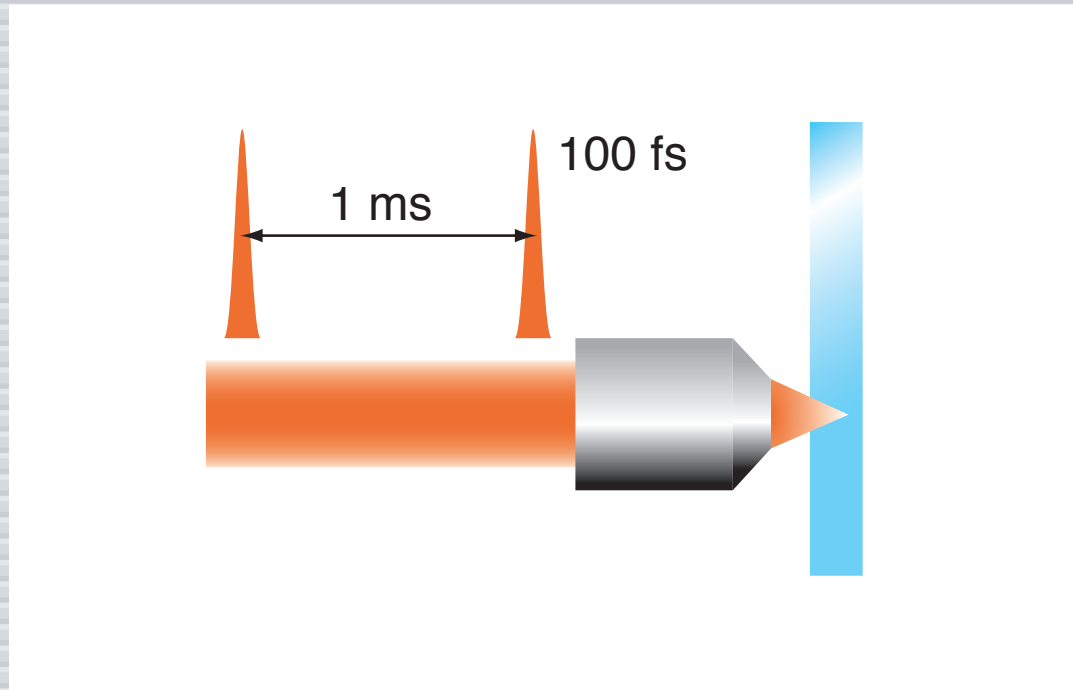

heat diffusion time: $\tau_{diff} \approx 1 \mu\text{s}$

Low-energy processing

long cavity oscillator: 25 MHz, 25 nJ

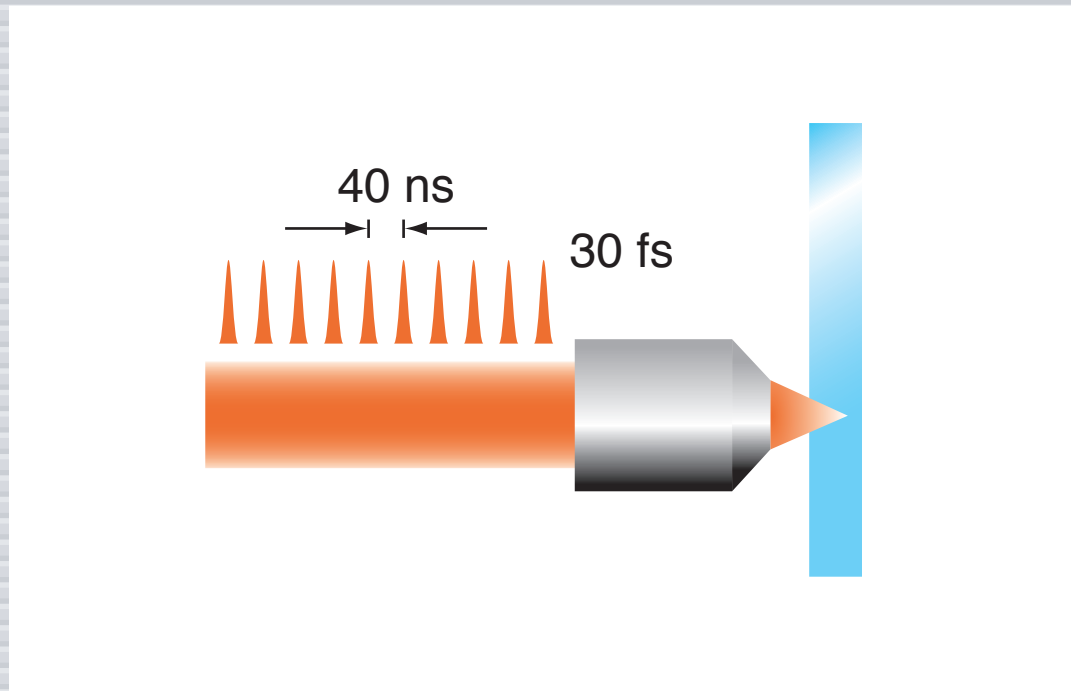

heat diffusion time: $\tau_{diff} \approx 1 \mu\text{s}$

Low-energy processing

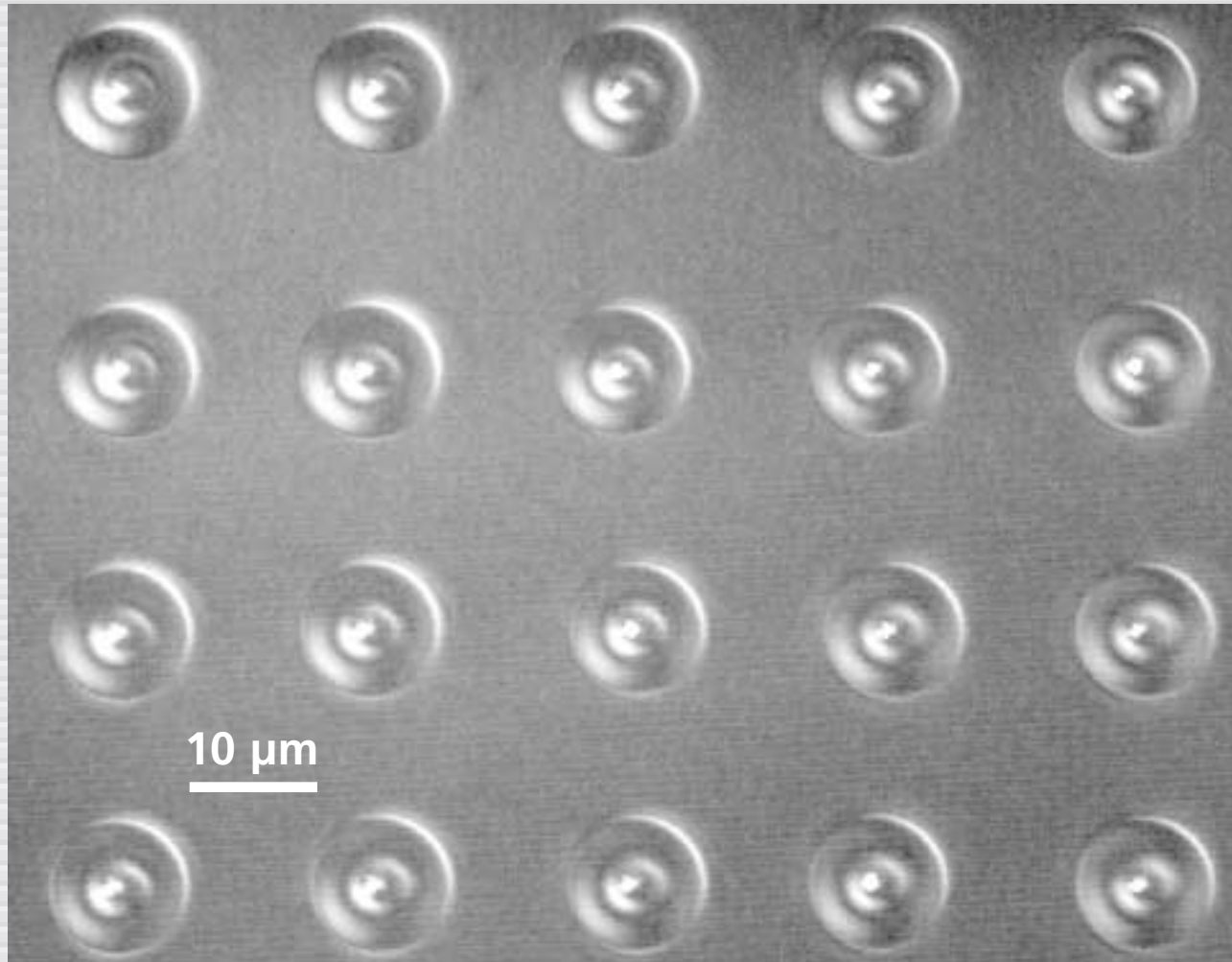

Low-energy processing

high repetition-rate micromachining:

- ▶ **structural changes exceed focal volume**
- ▶ **spherical structures**
- ▶ **density change caused by melting**

Low-energy processing

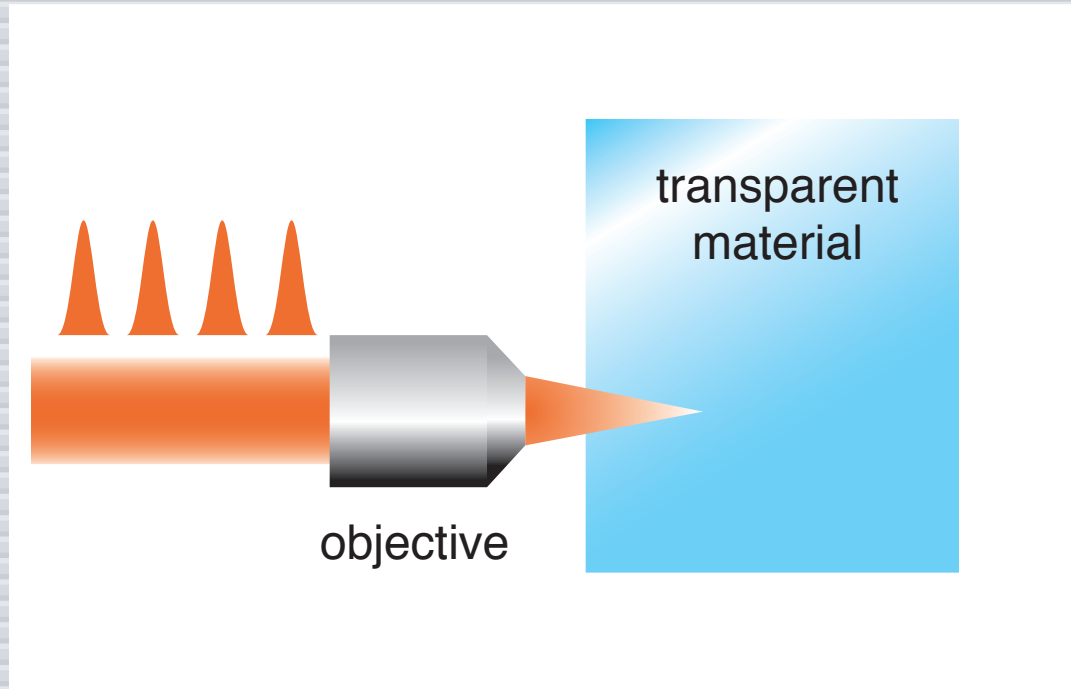

cumulative energy deposition

Low-energy processing

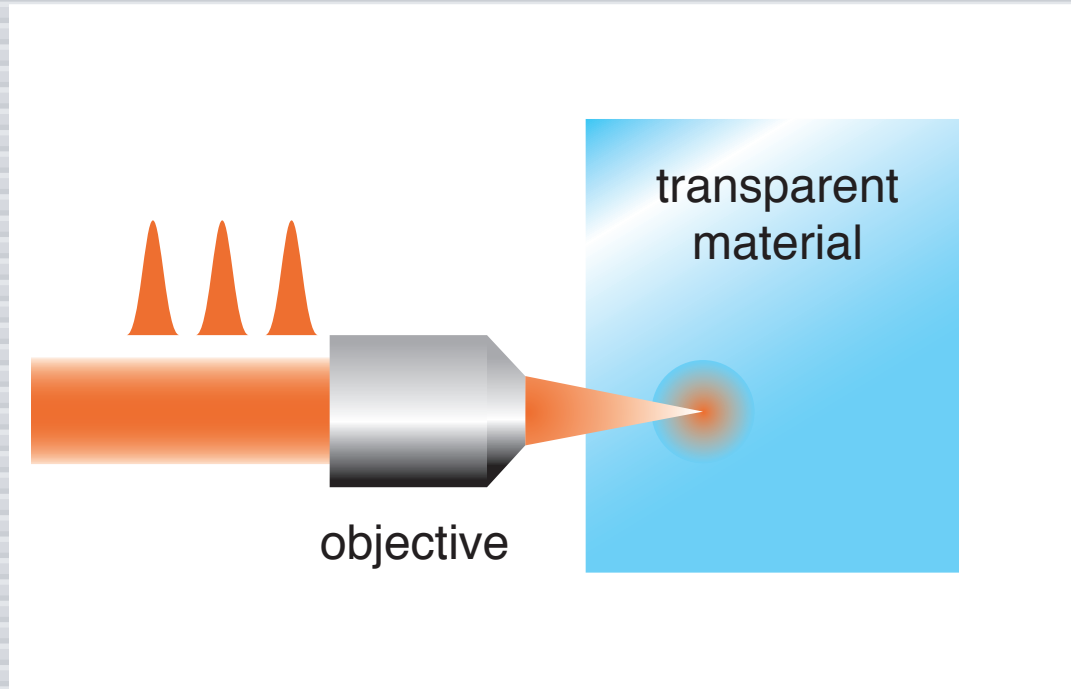

cumulative energy deposition

Low-energy processing

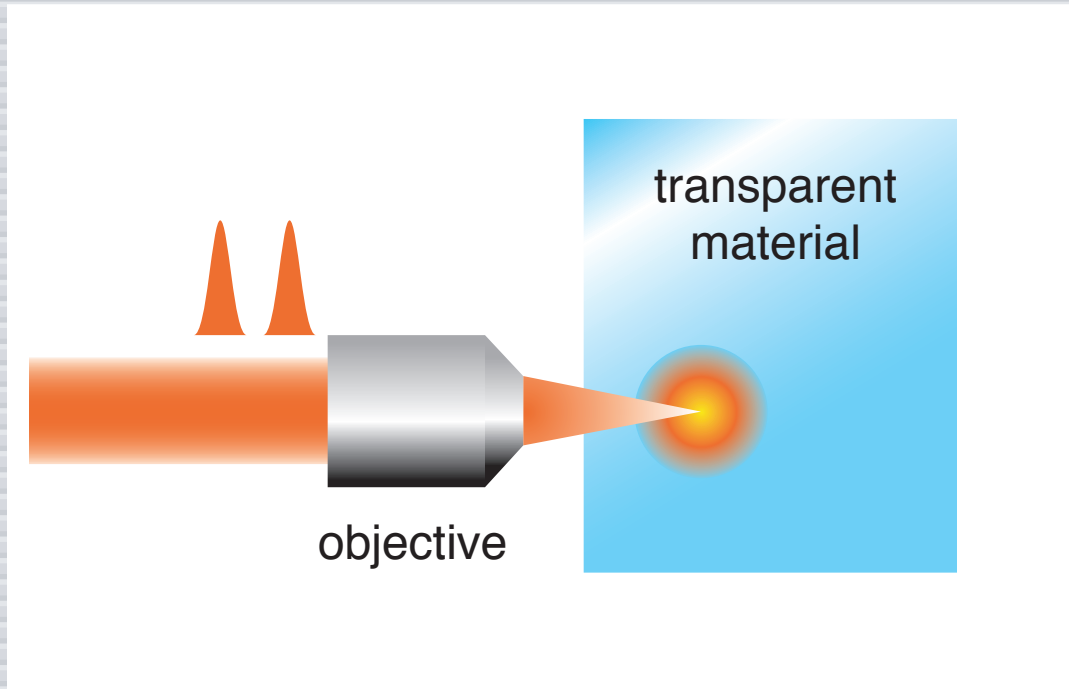

cumulative energy deposition

Low-energy processing

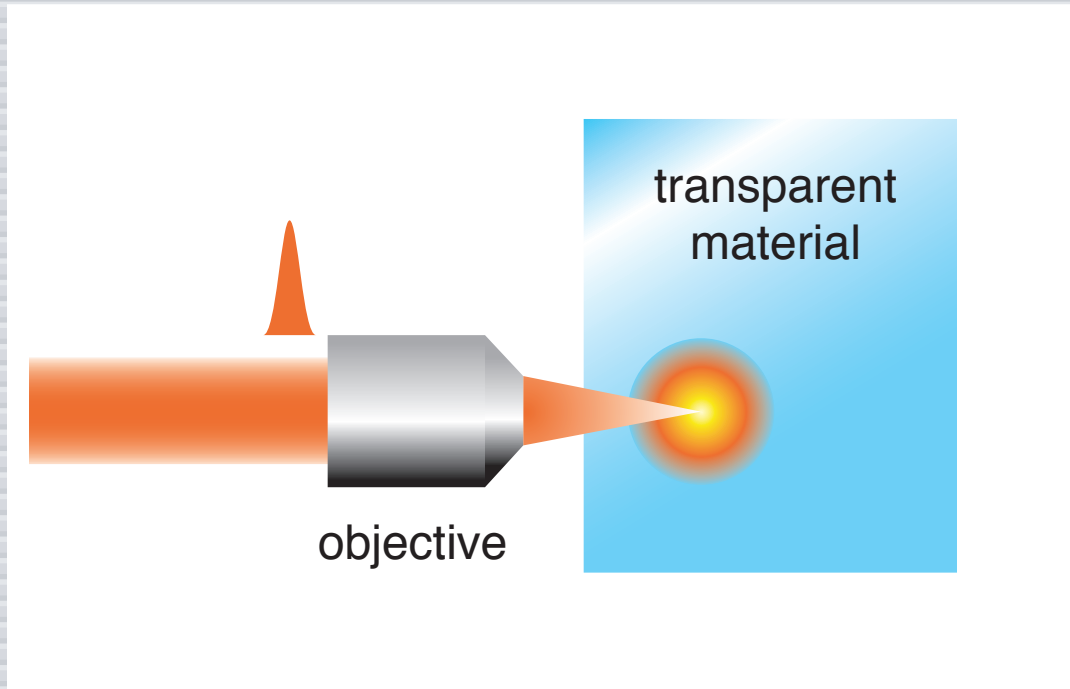

cumulative energy deposition

Low-energy processing

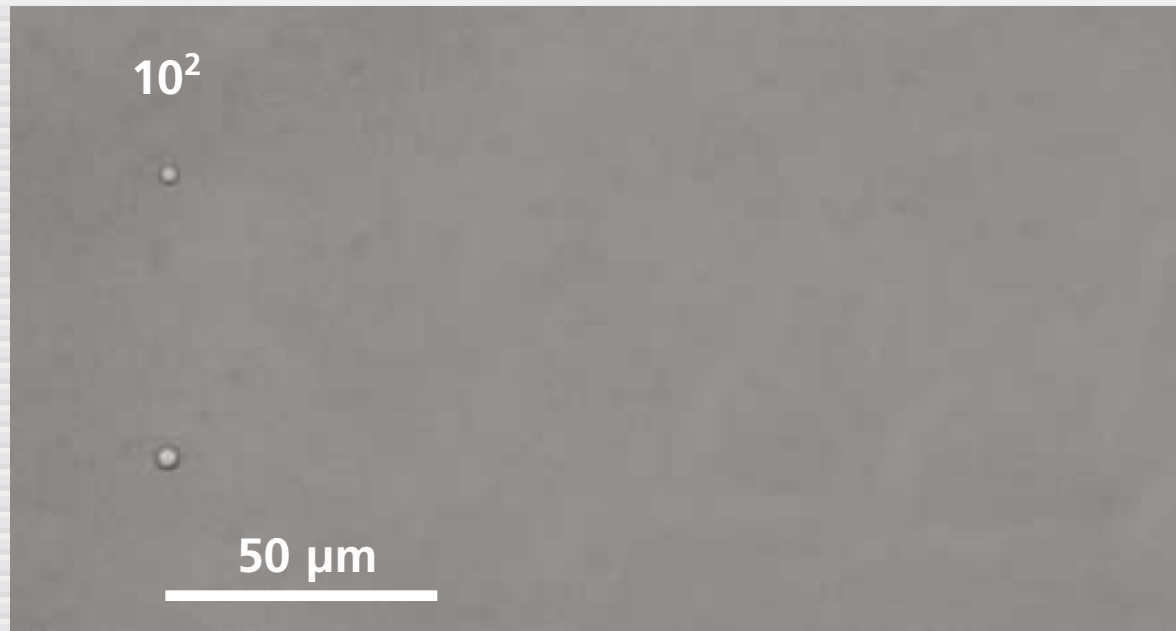

Low-energy processing

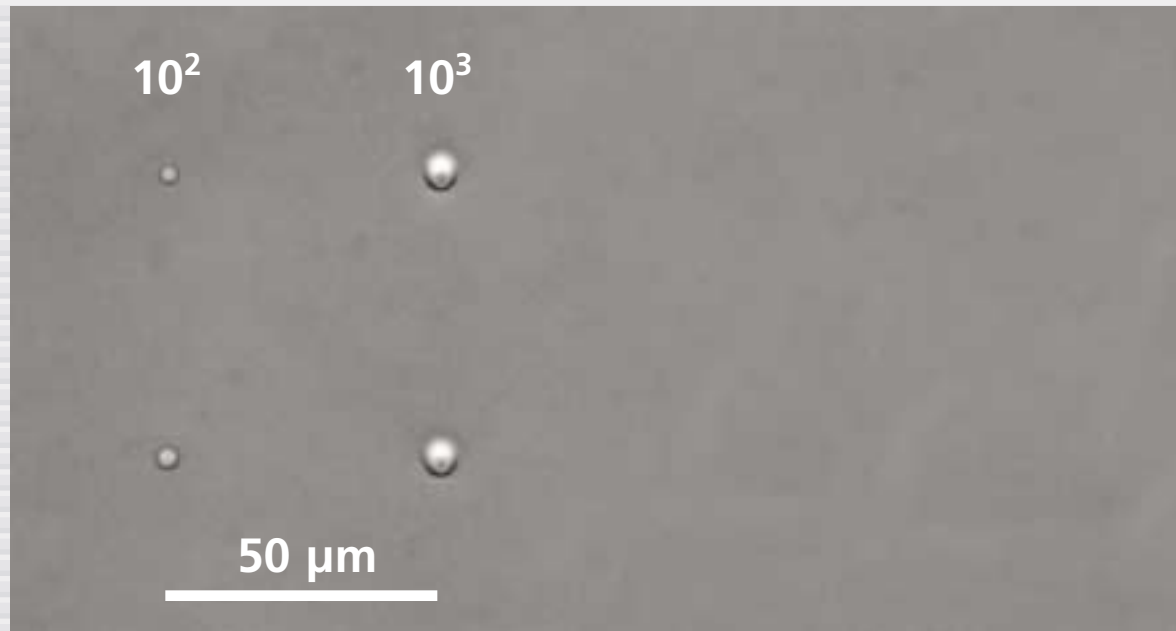

Low-energy processing

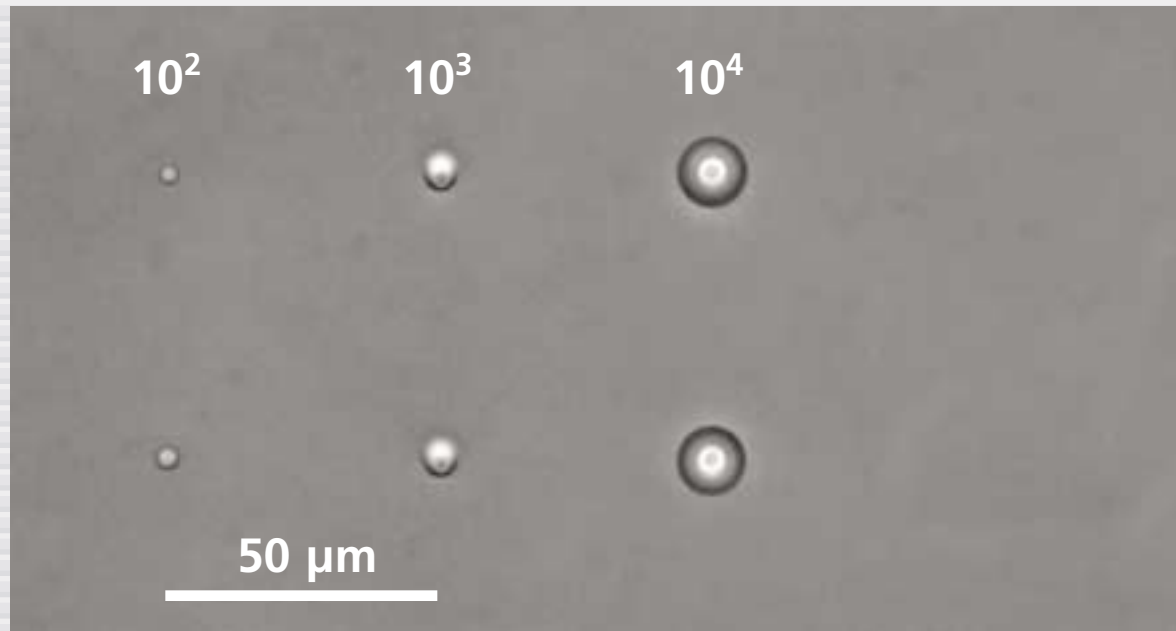

Low-energy processing

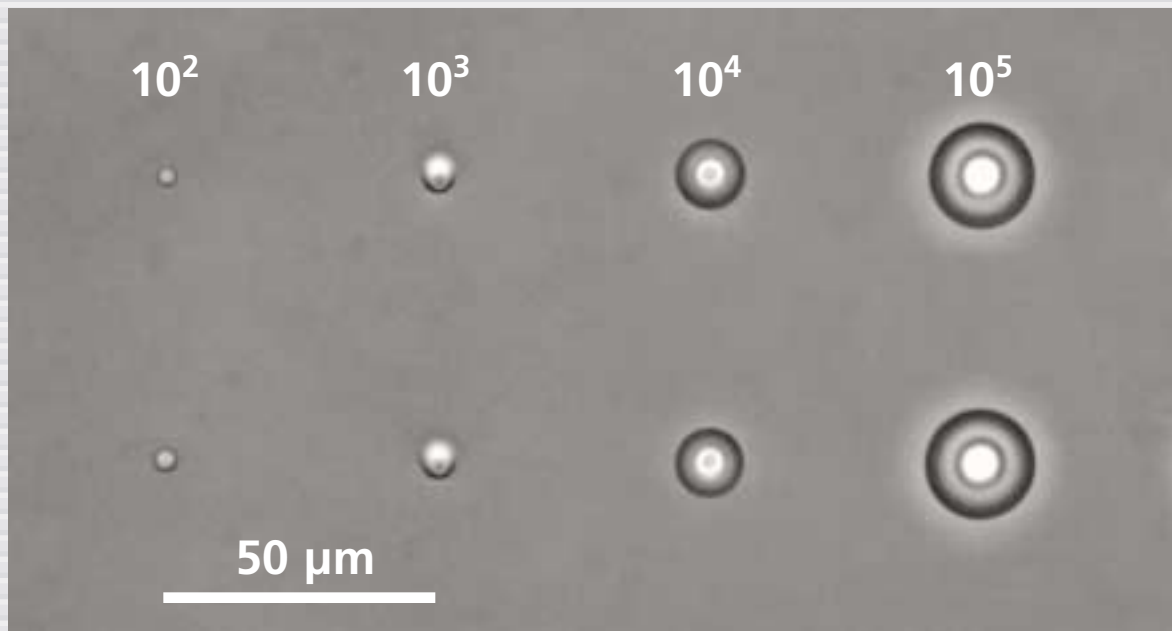

Low-energy processing

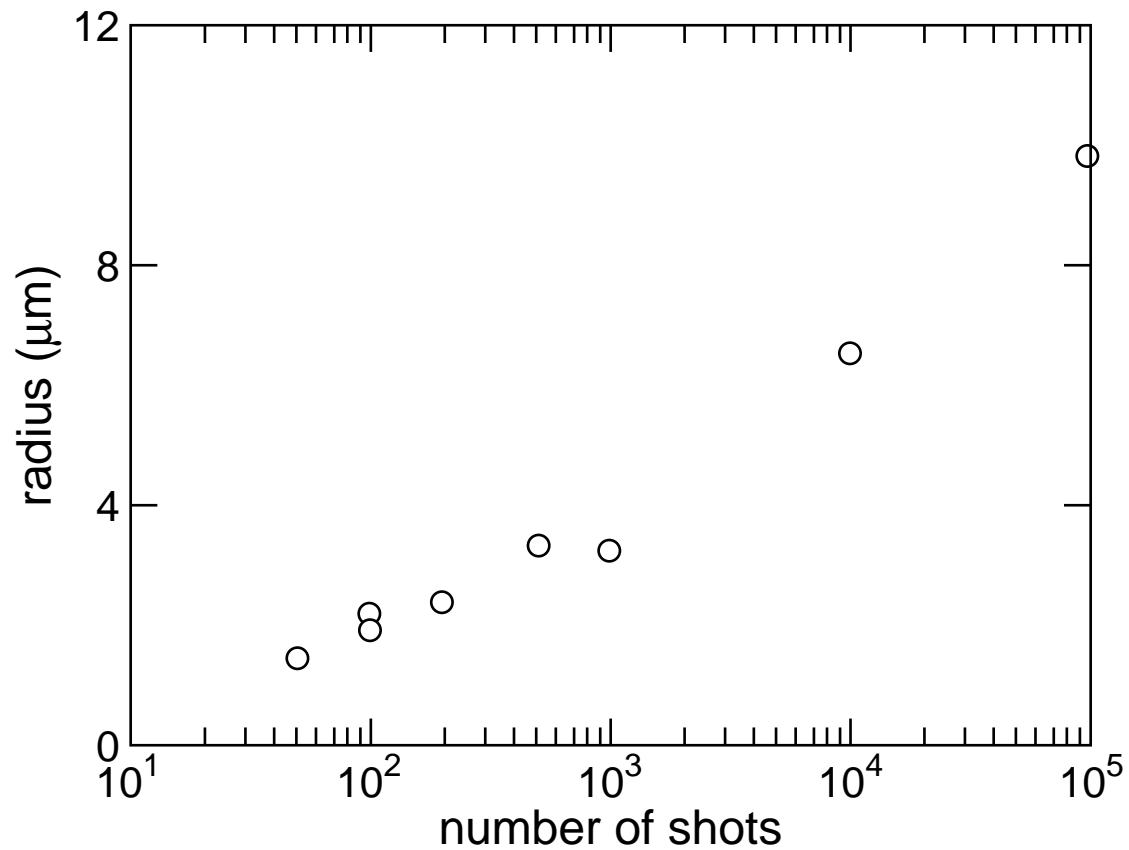

Low-energy processing

amplified laser

oscillator

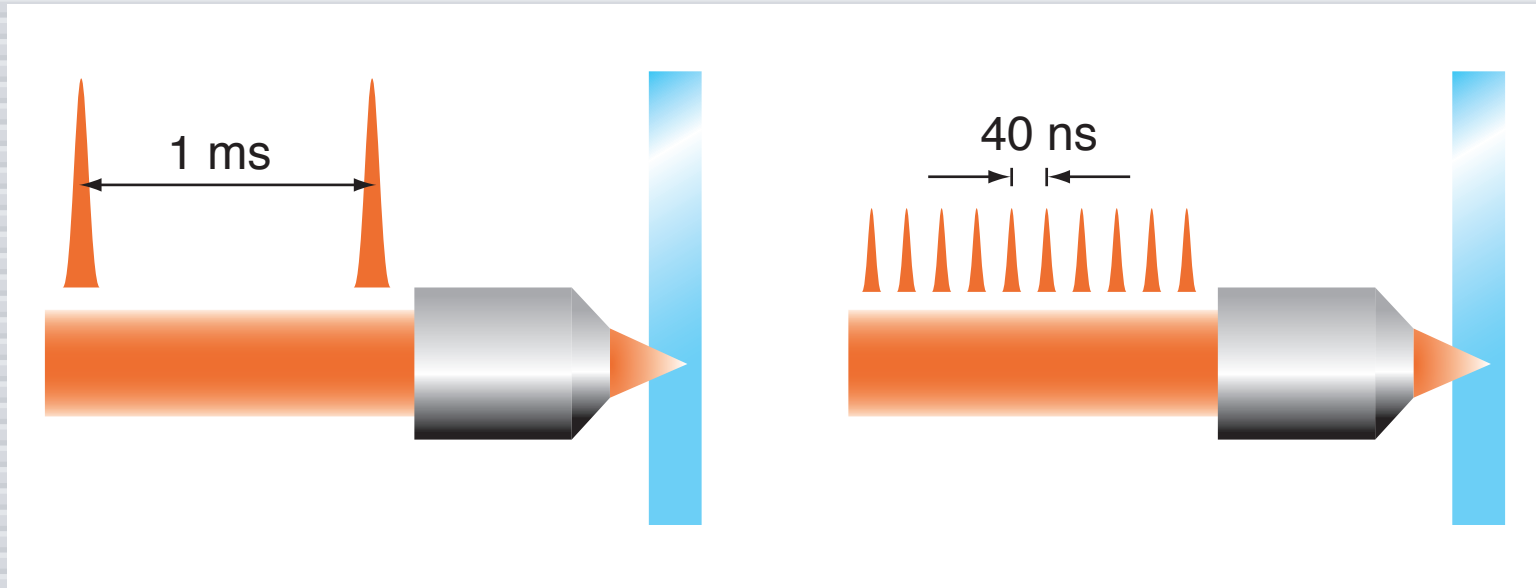

repetitive

cumulative

Low-energy processing

repetition-rate dependence

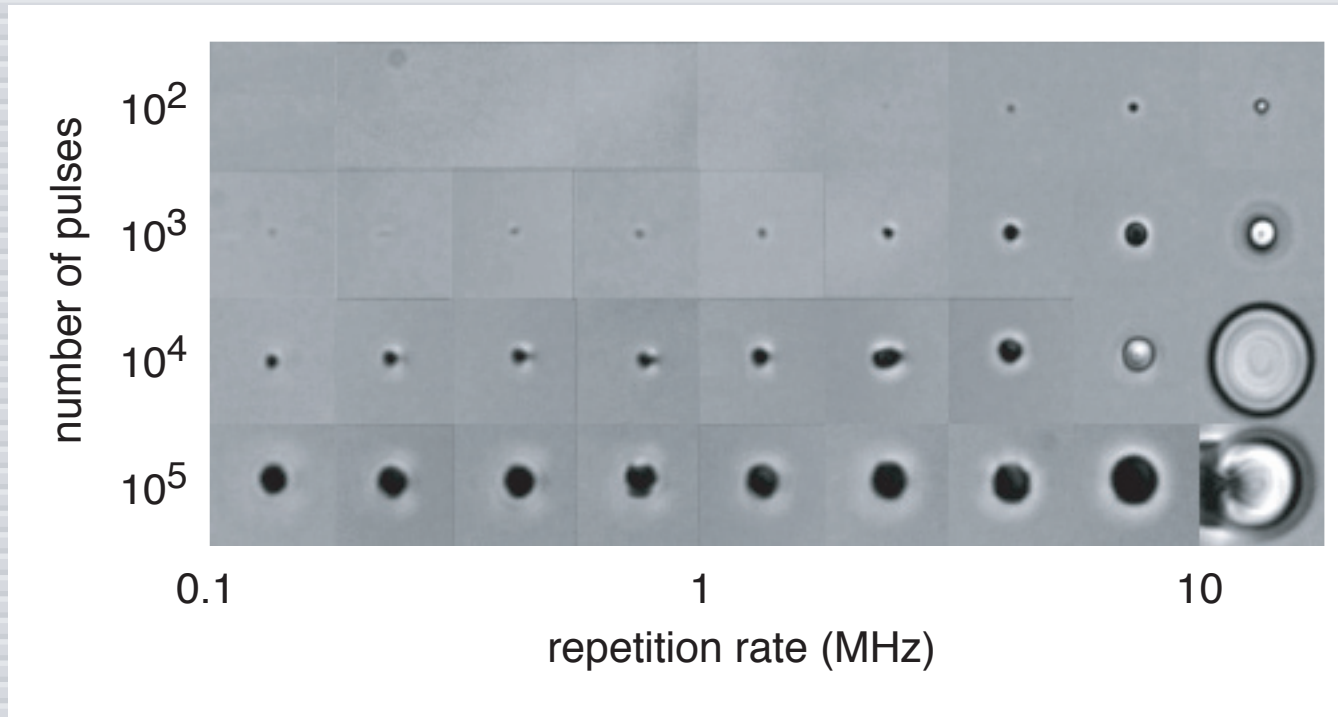

As_2S_3 , 100 fs, 7 nJ

Low-energy processing

repetition-rate dependence

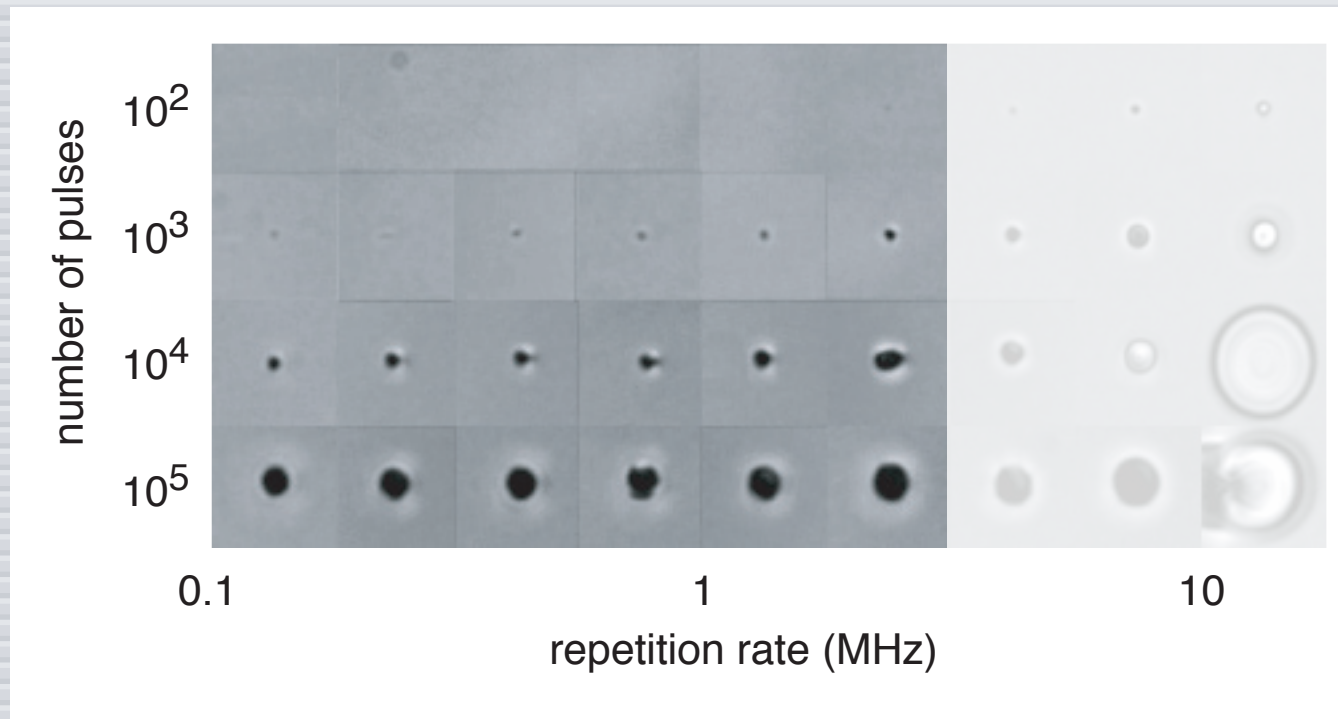

As_2S_3 , 100 fs, 7 nJ

Low-energy processing

repetition-rate dependence

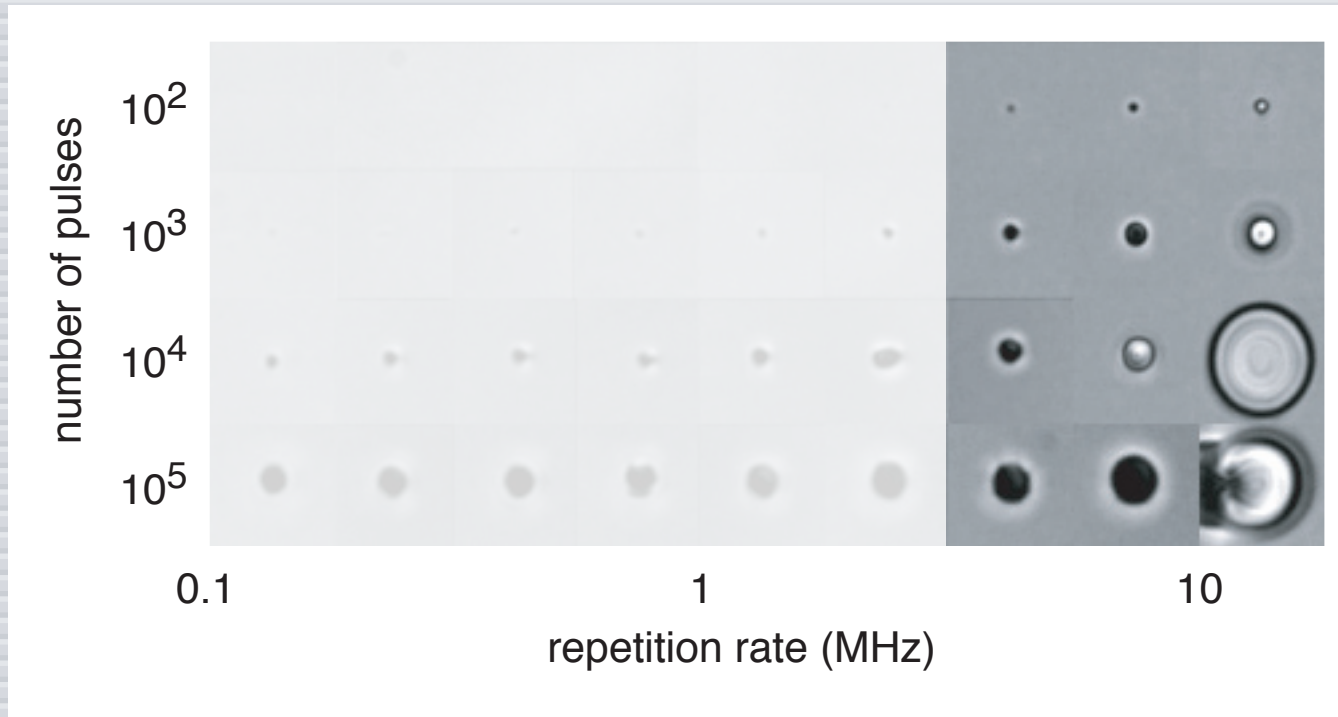

As_2S_3 , 100 fs, 7 nJ

Low-energy processing

repetition-rate dependence

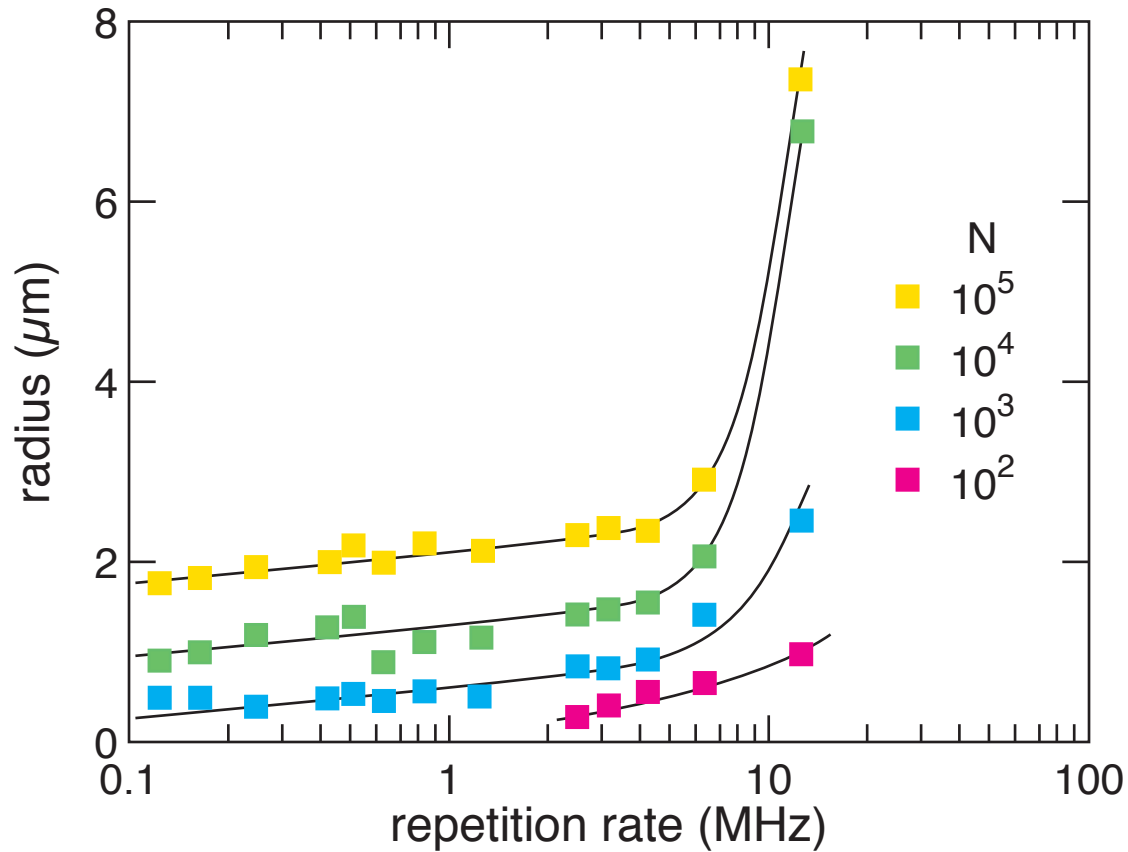

As_2S_3 , 100 fs, 7 nJ

Low-energy processing

waveguide machining

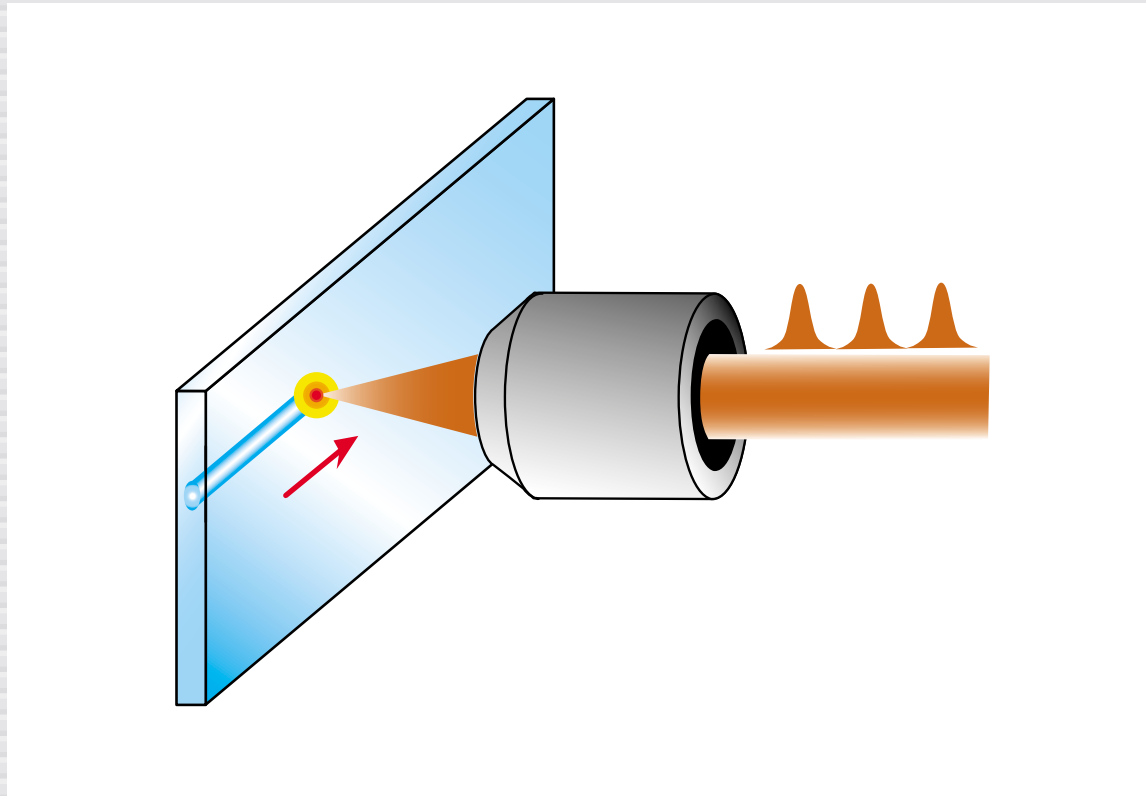

Low-energy processing

waveguide machining

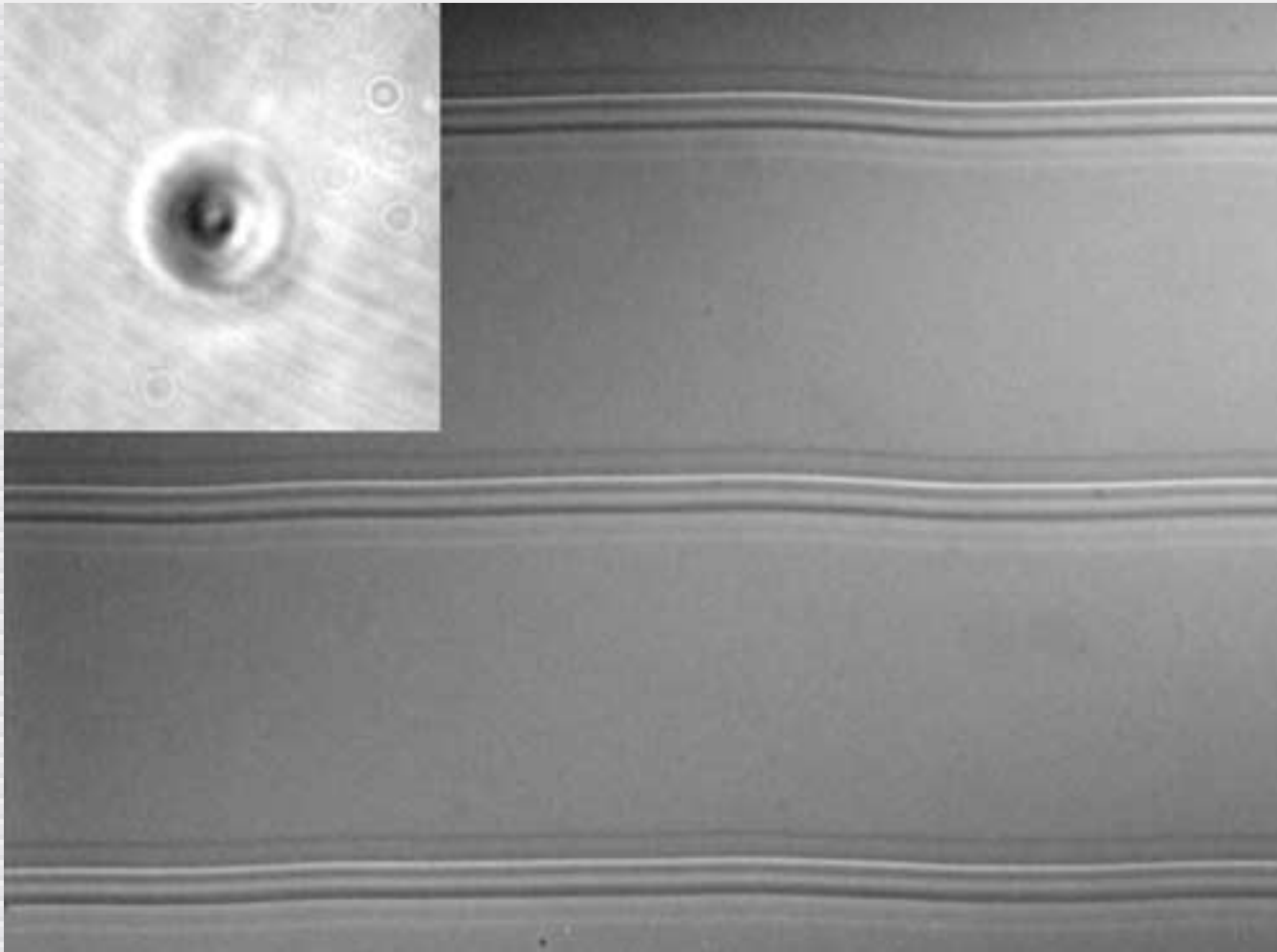

Low-energy processing

waveguide mode analysis

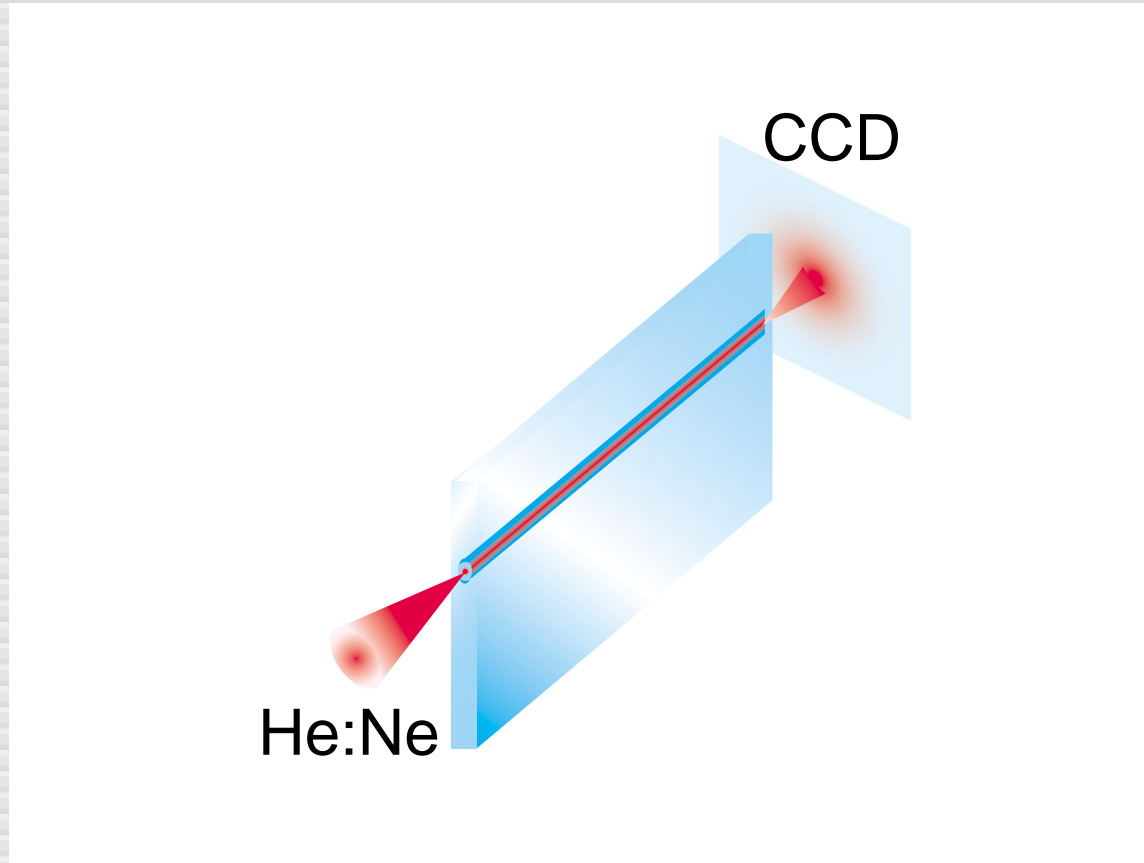

Low-energy processing

near field mode

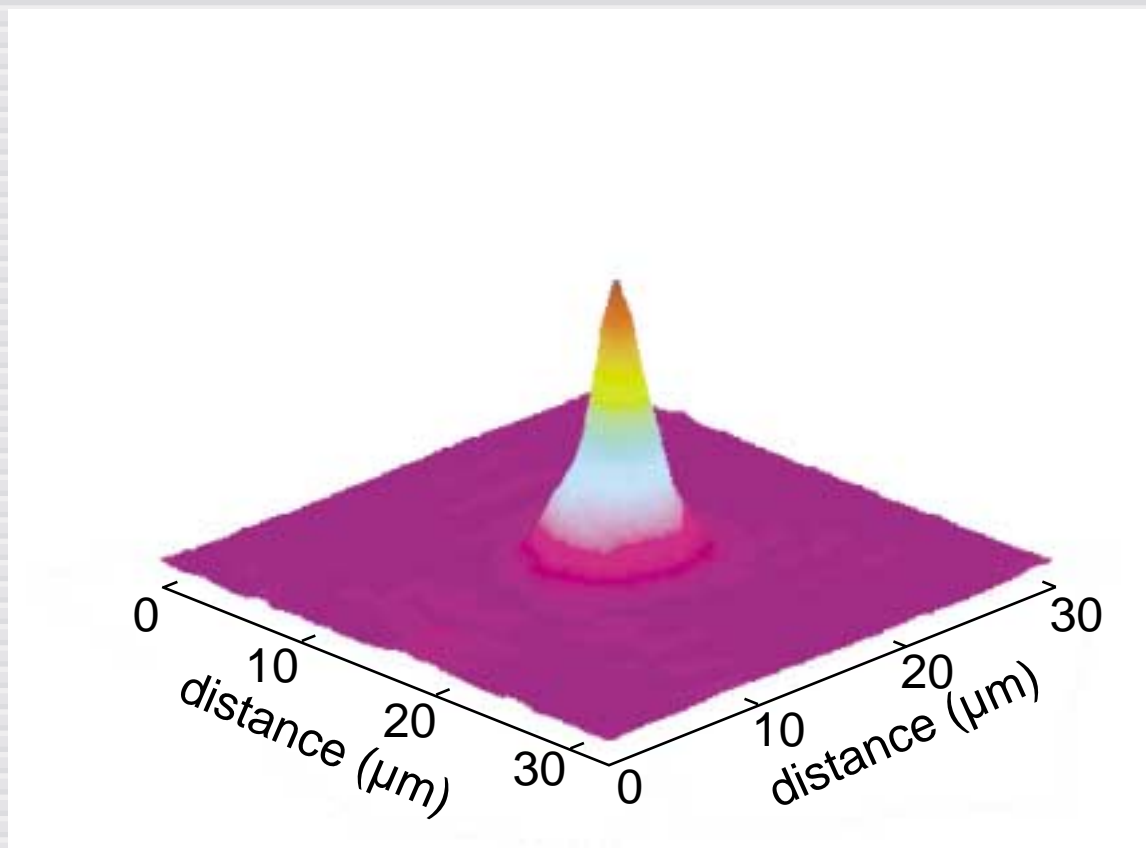

Low-energy processing

near field mode

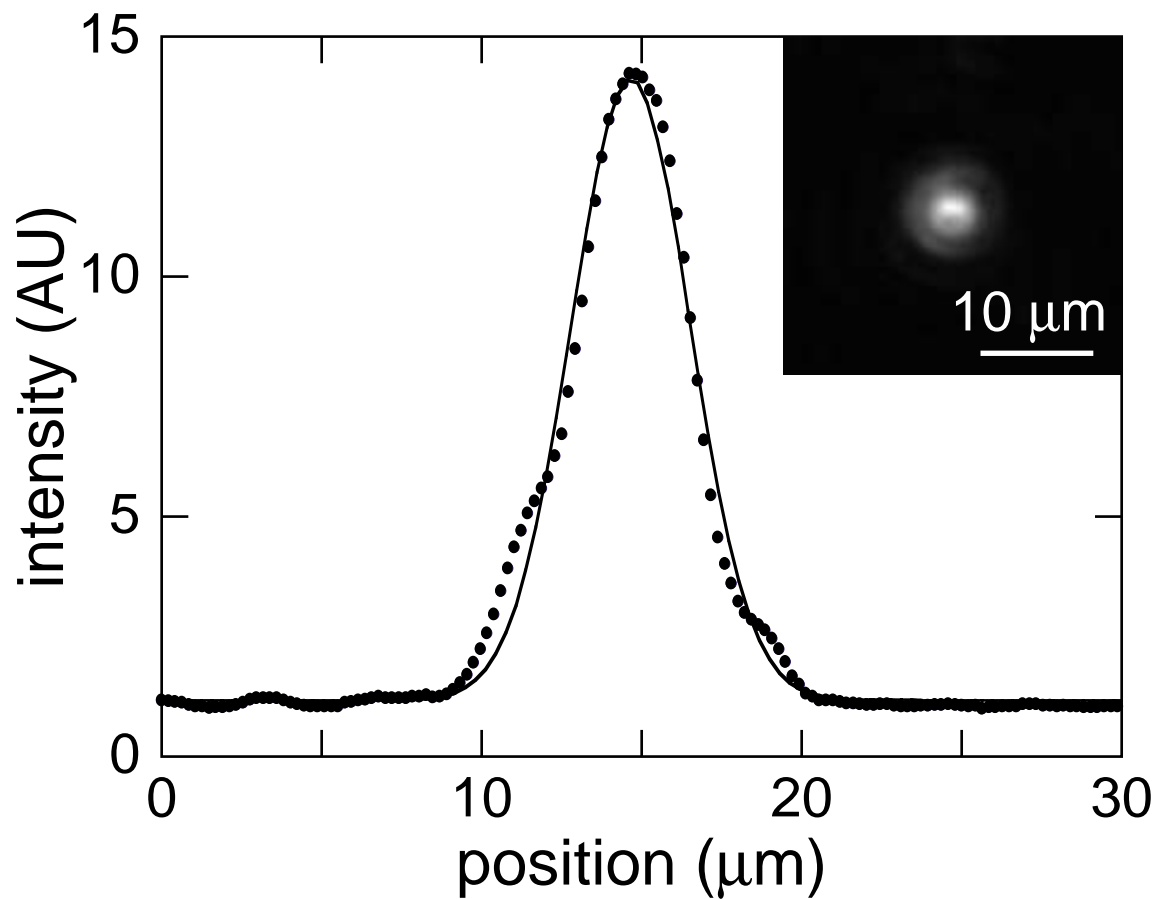

Low-energy processing

refractive index profiles and near field mode at 633 nm

5 mm/s

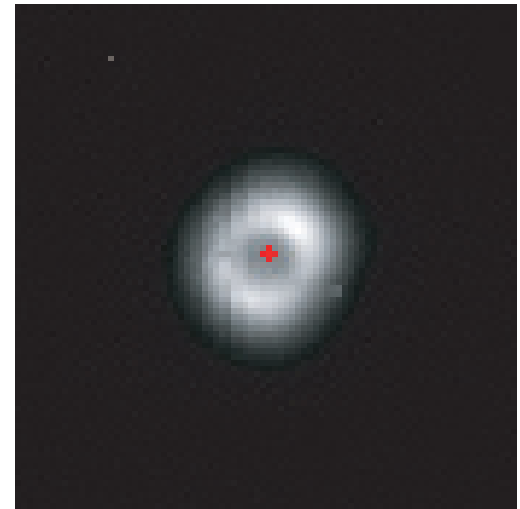
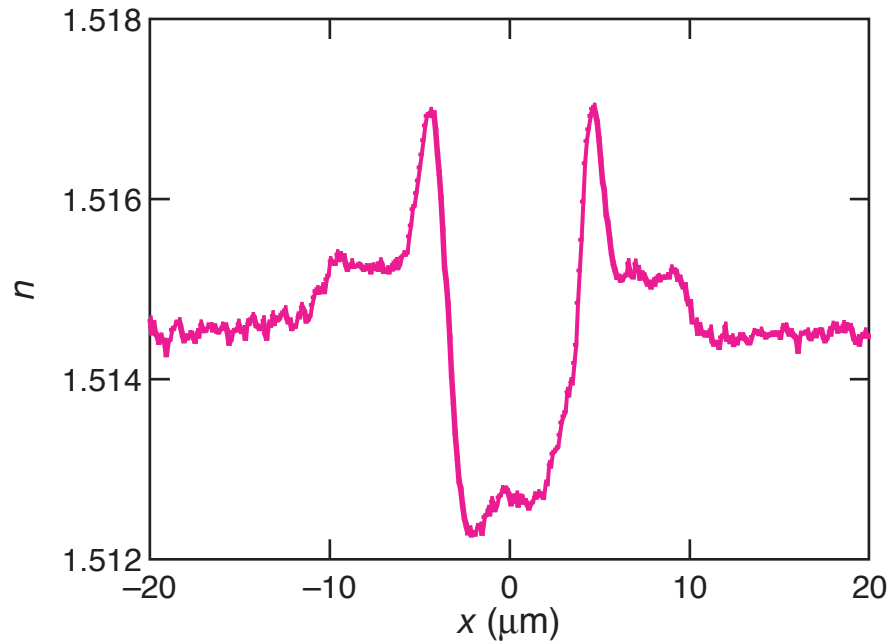

Low-energy processing

refractive index profiles and near field mode at 633 nm

10 mm/s

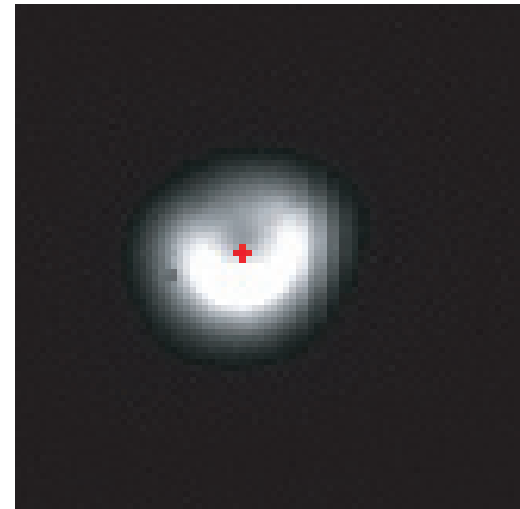
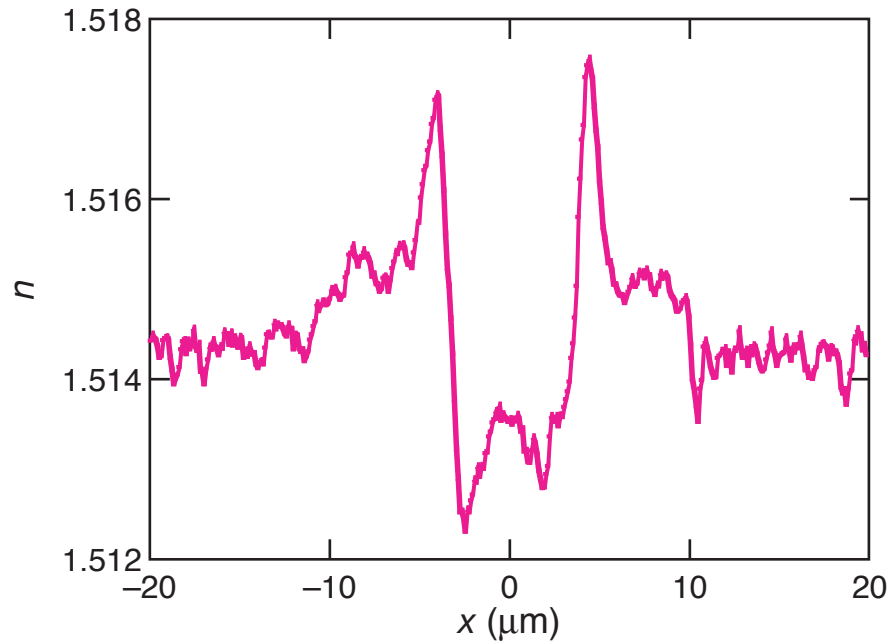

Low-energy processing

refractive index profiles and near field mode at 633 nm

20 mm/s

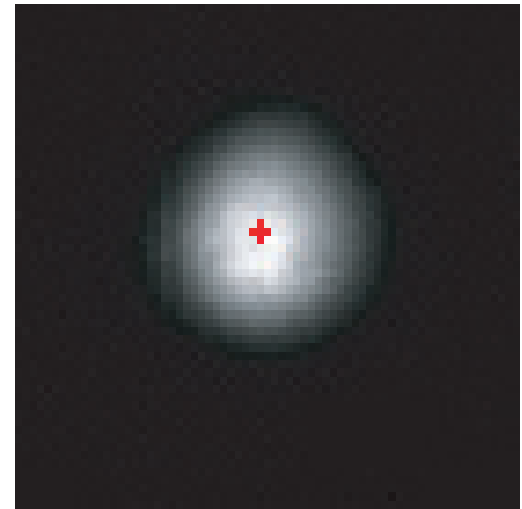
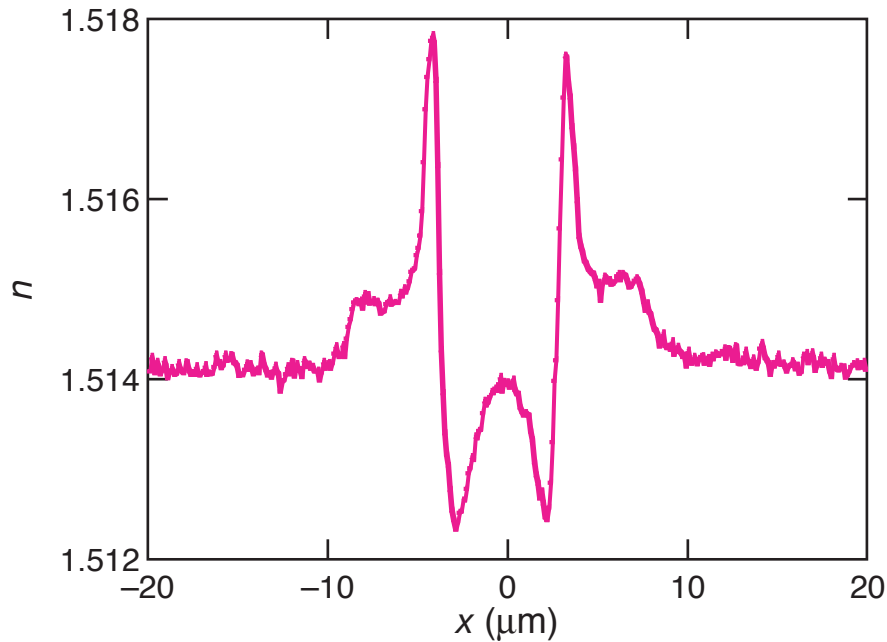

Low-energy processing

curved waveguides

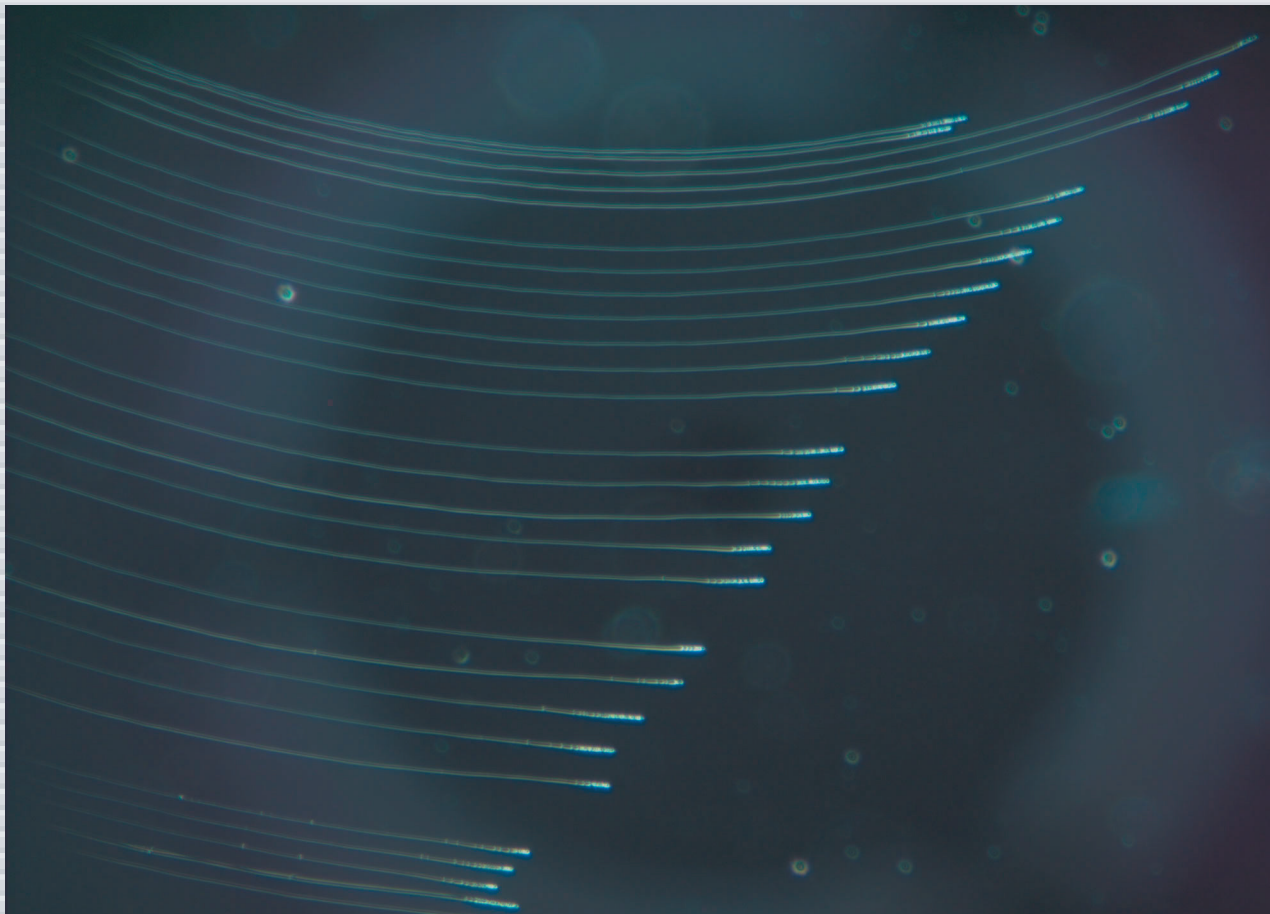

Low-energy processing

3D wave splitter

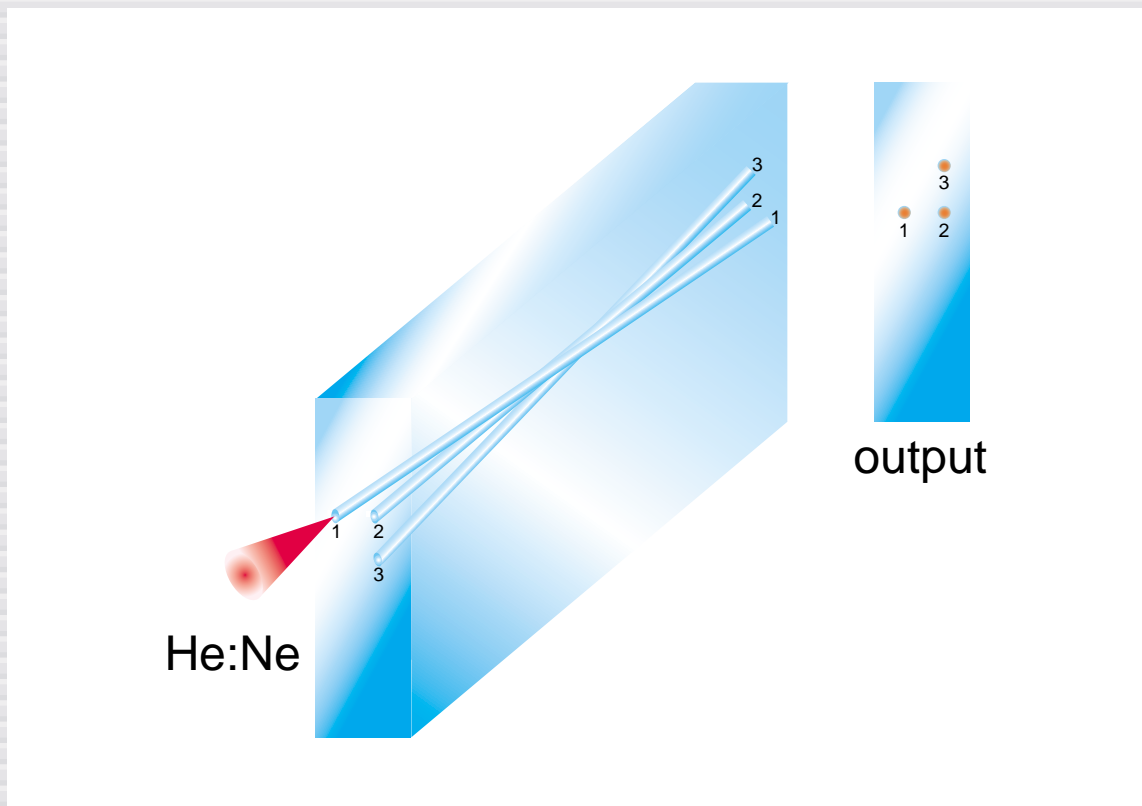

Low-energy processing

Bragg grating

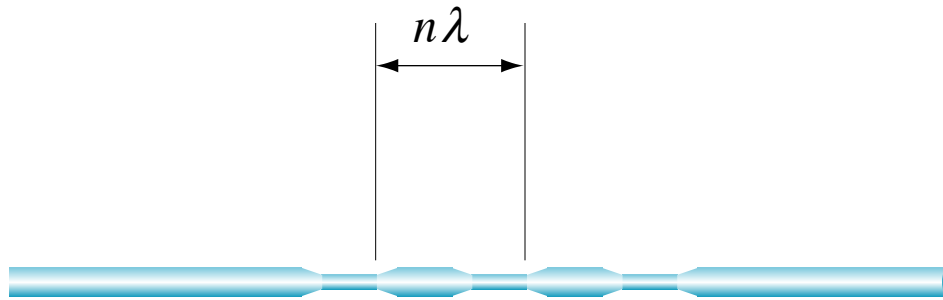

Low-energy processing

Bragg grating

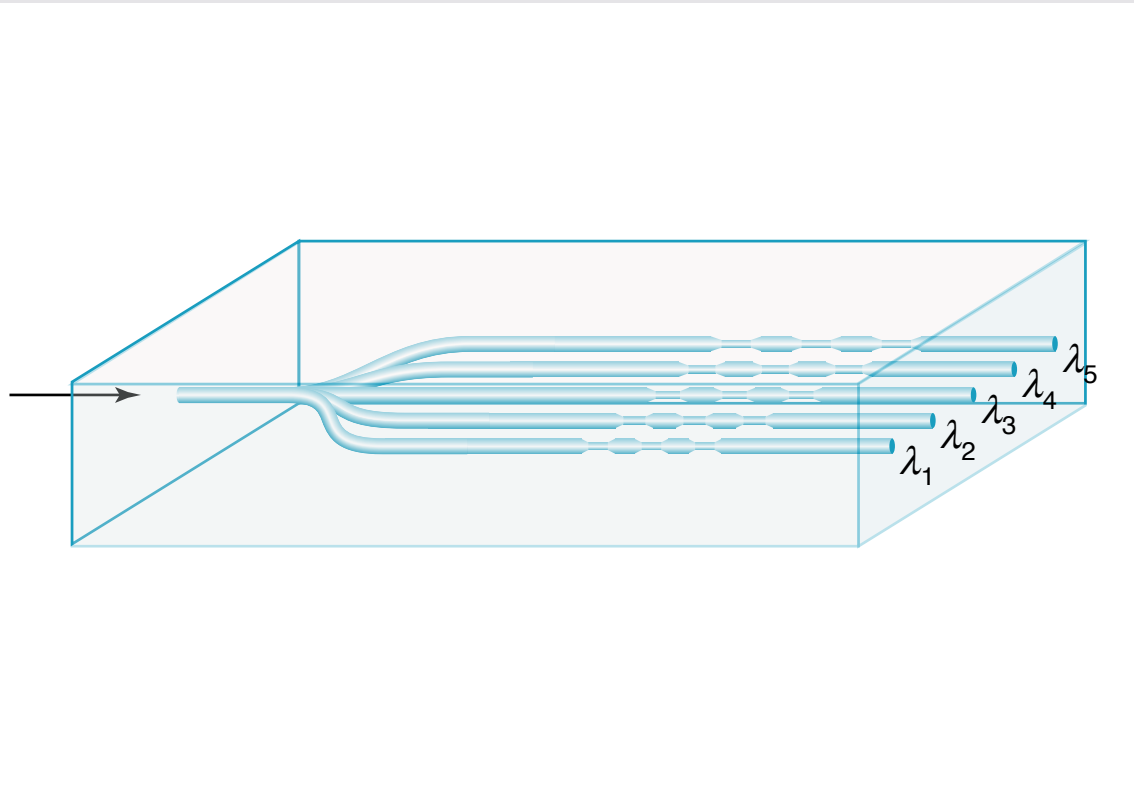

Low-energy processing

monolithic amplifier



laser active glass

Low-energy processing

epi-fluorescence microscope

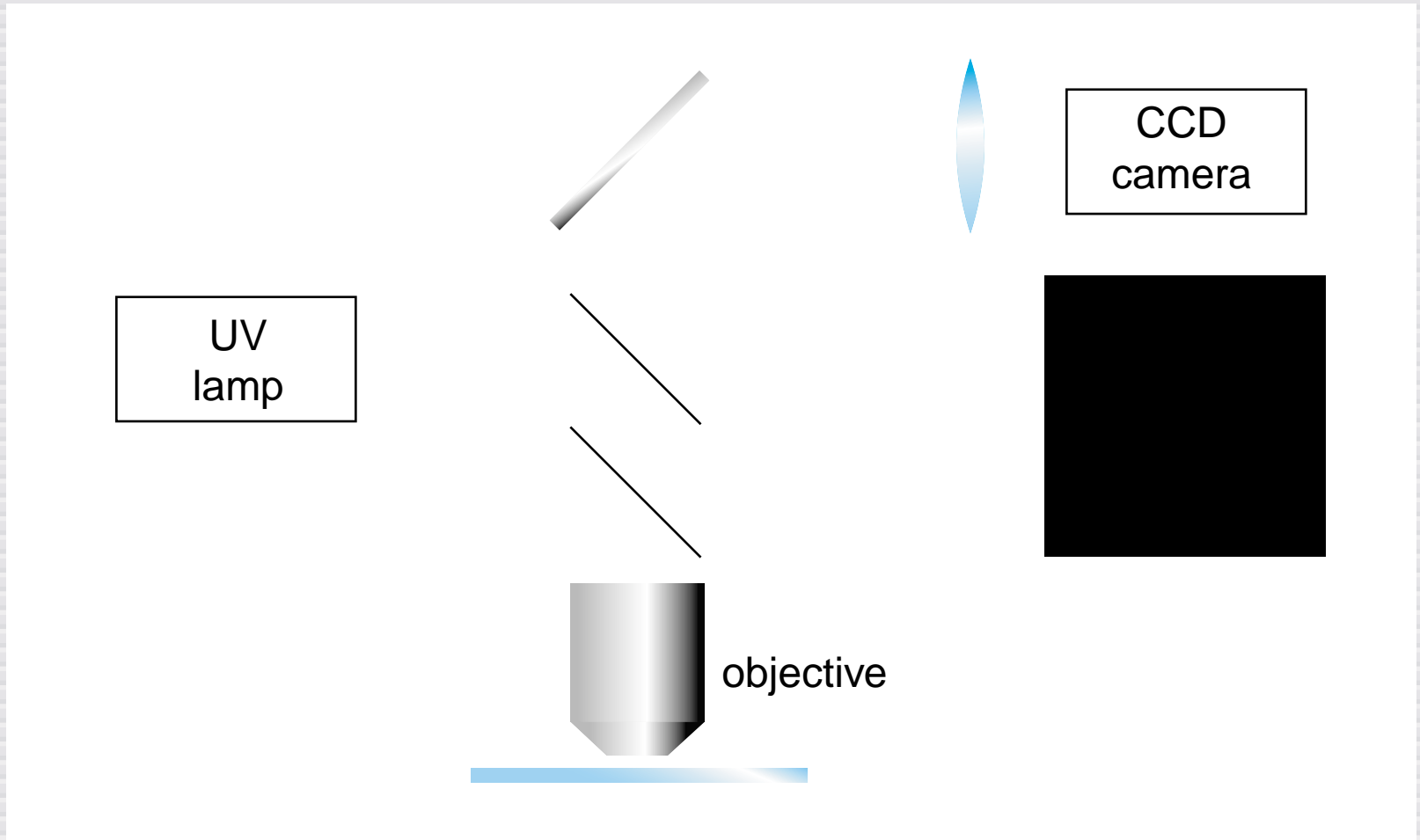

Low-energy processing

mount fluorescently tagged sample

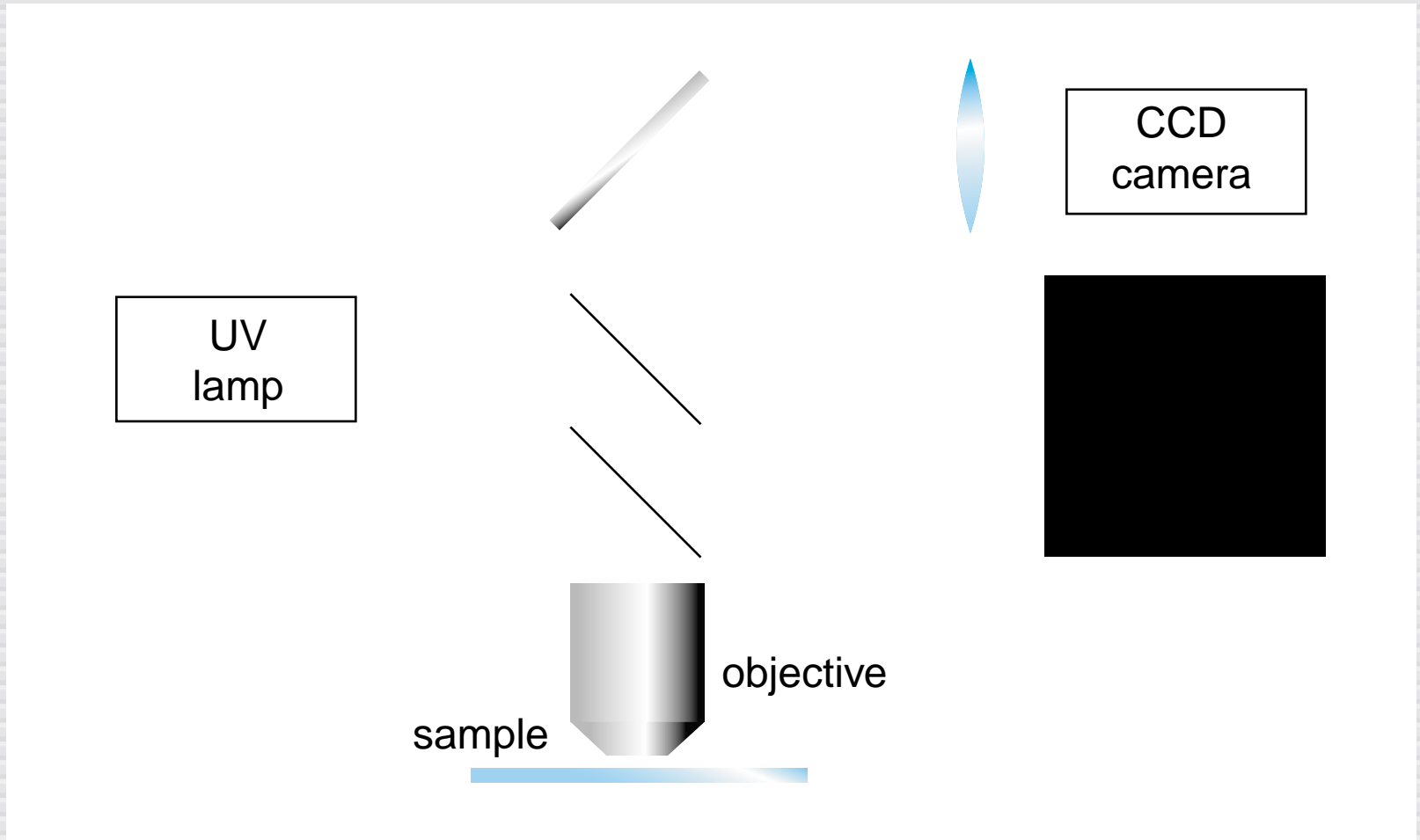

Low-energy processing

UV illumination...

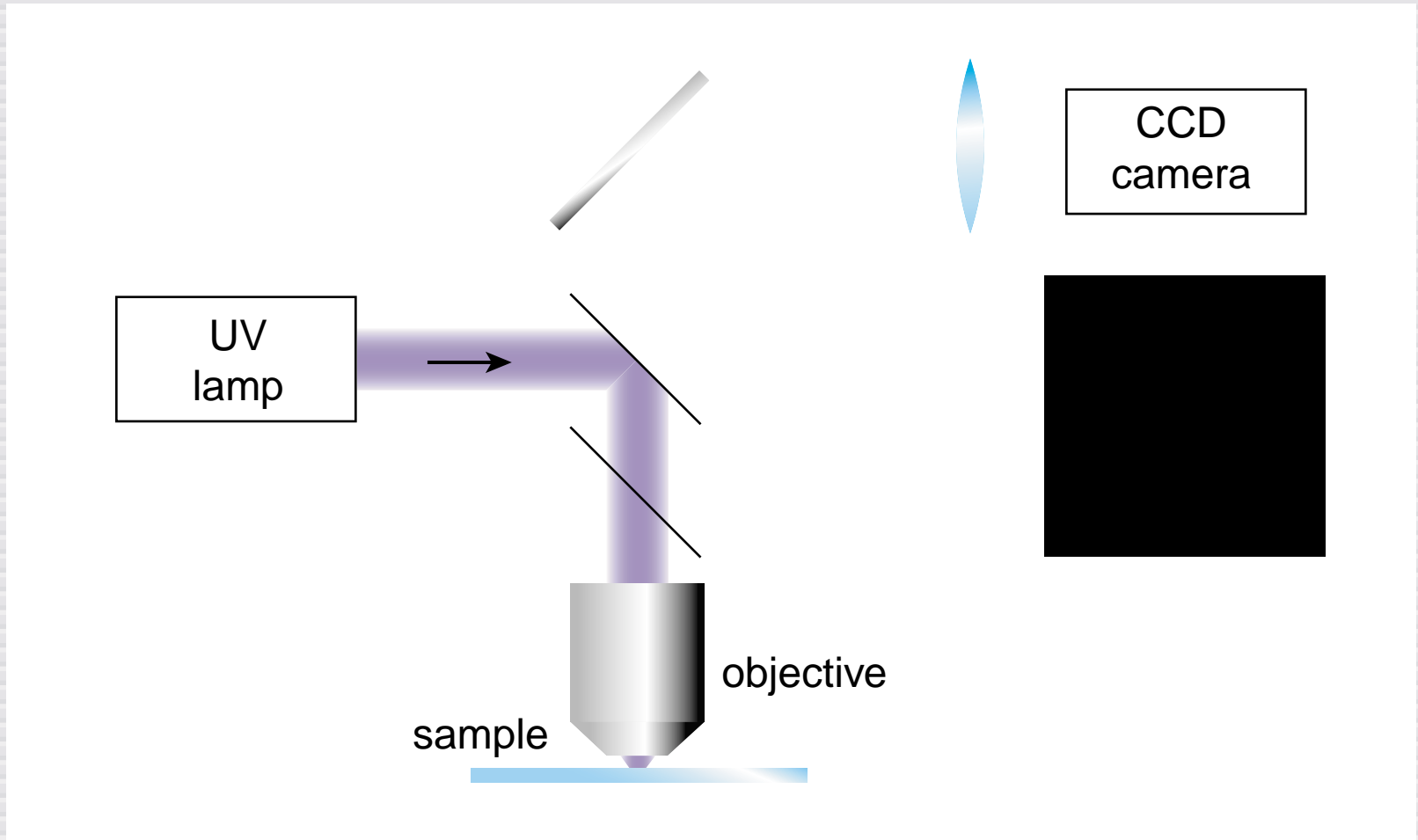

Low-energy processing

... causes fluorescence

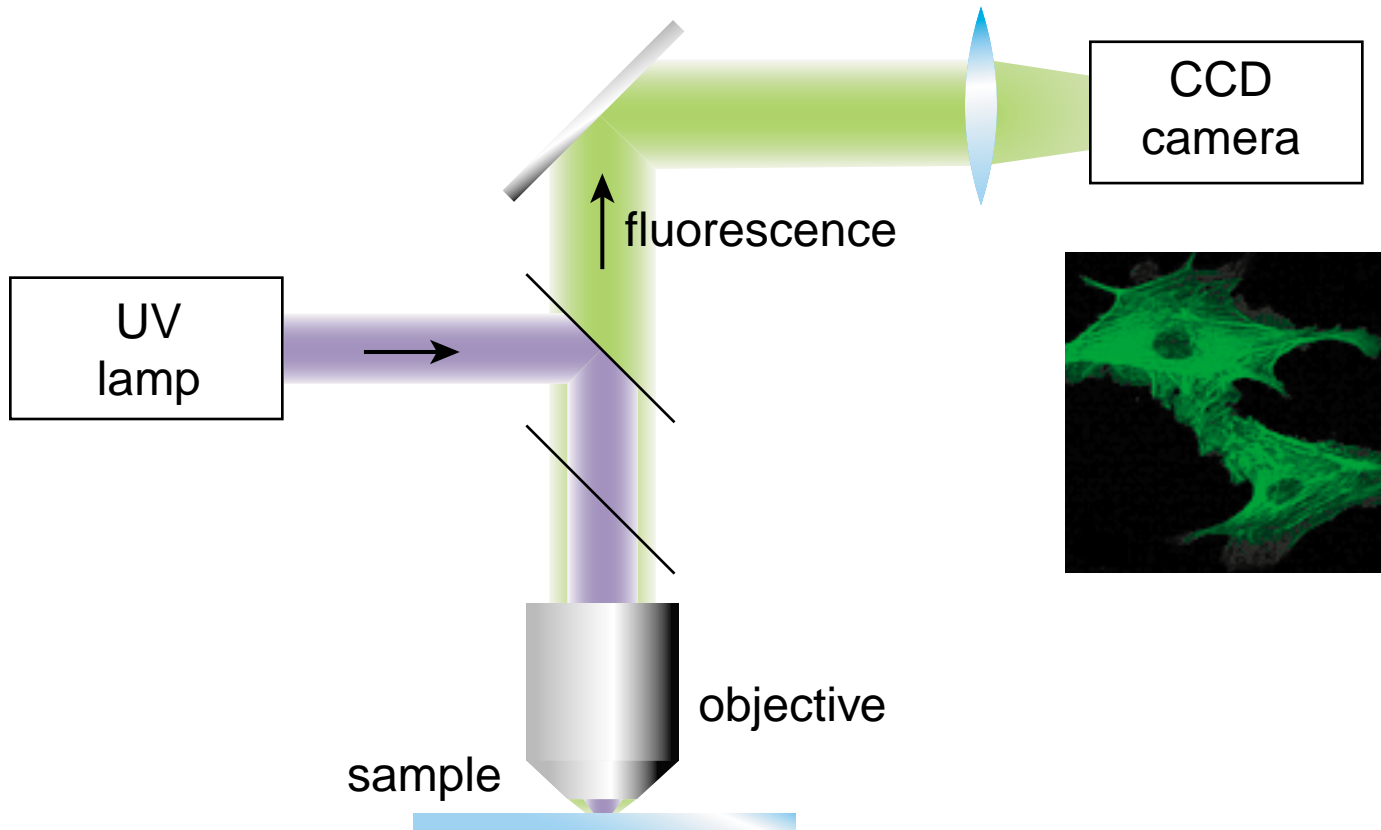

Low-energy processing

process with fs laser beam

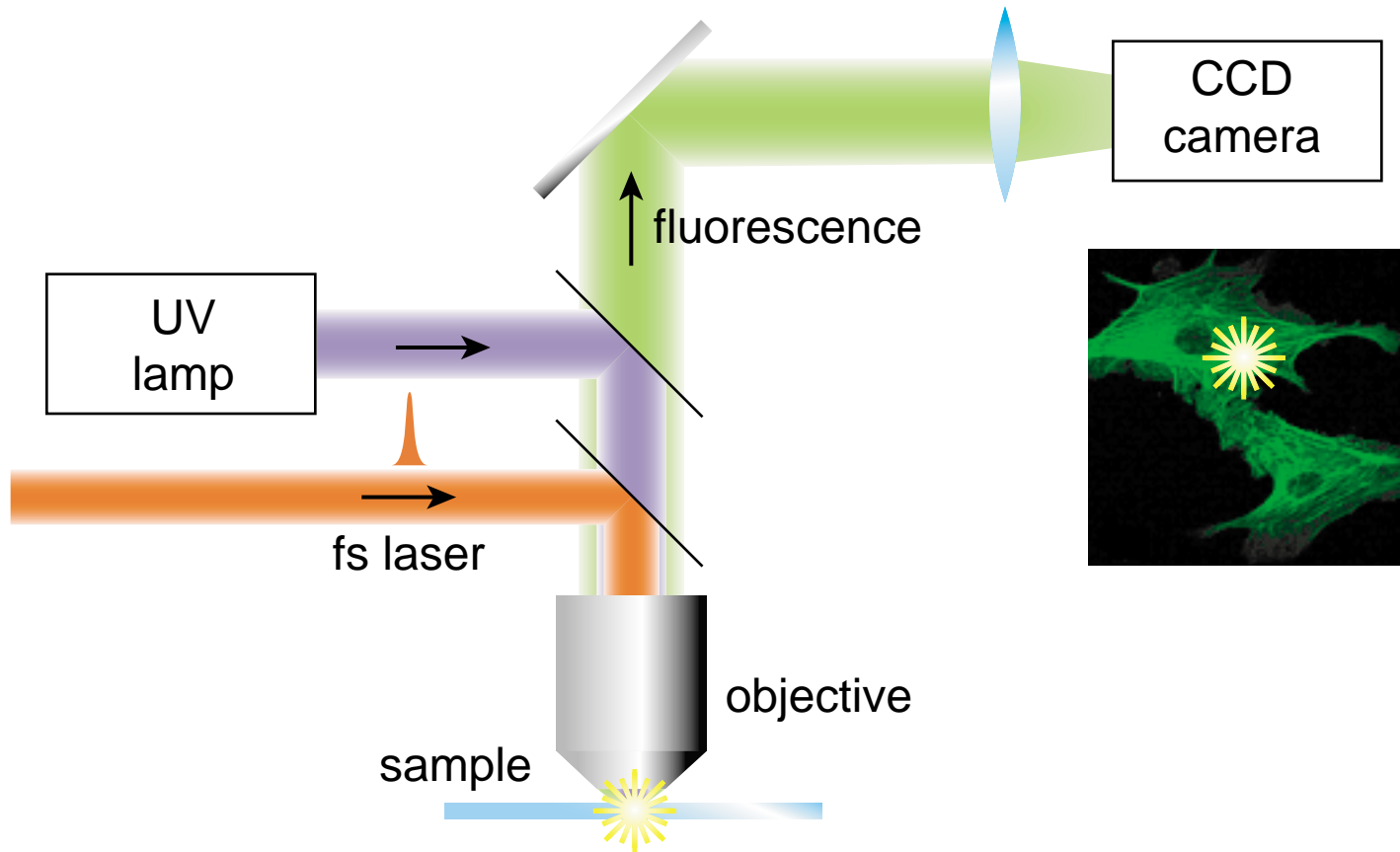

Low-energy processing

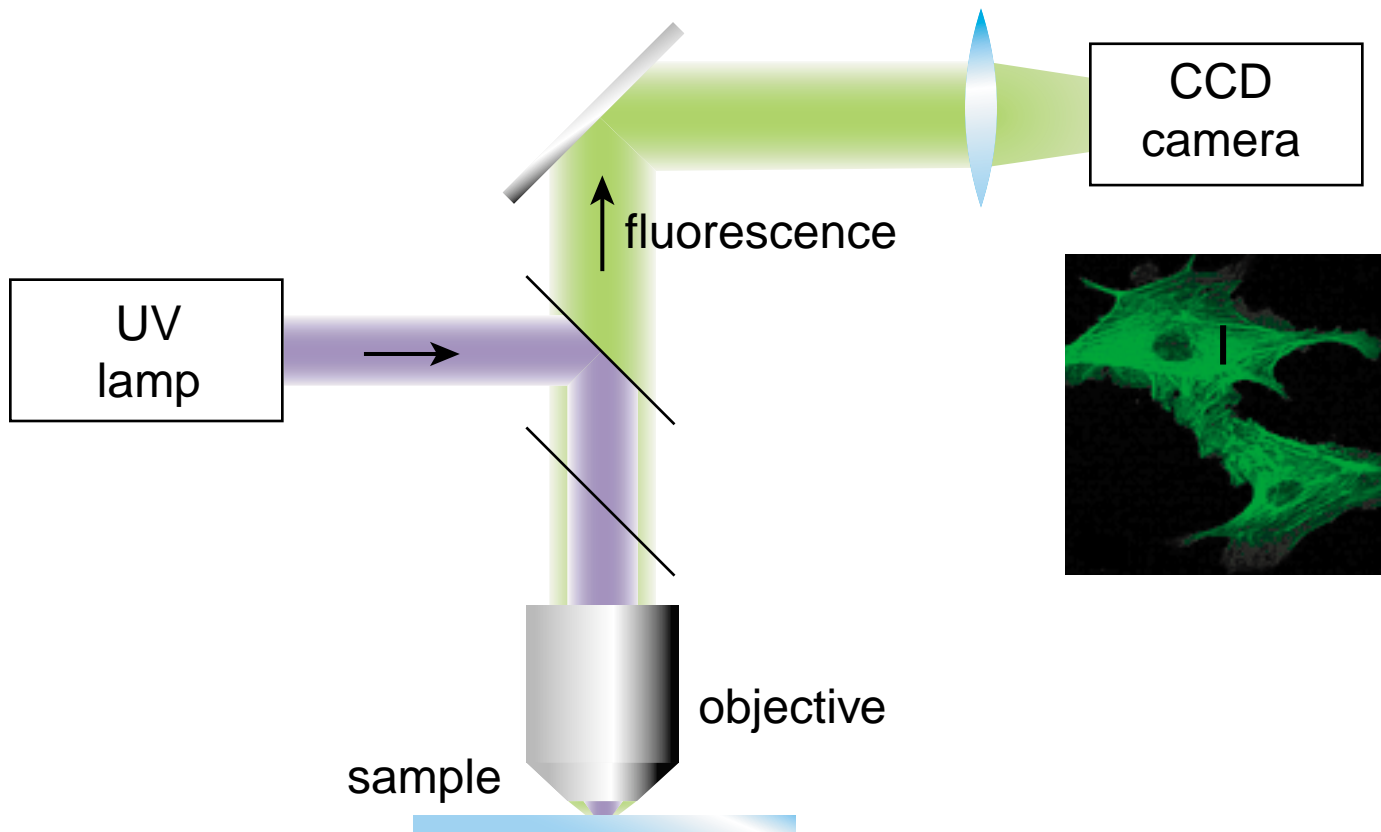

Low-energy processing

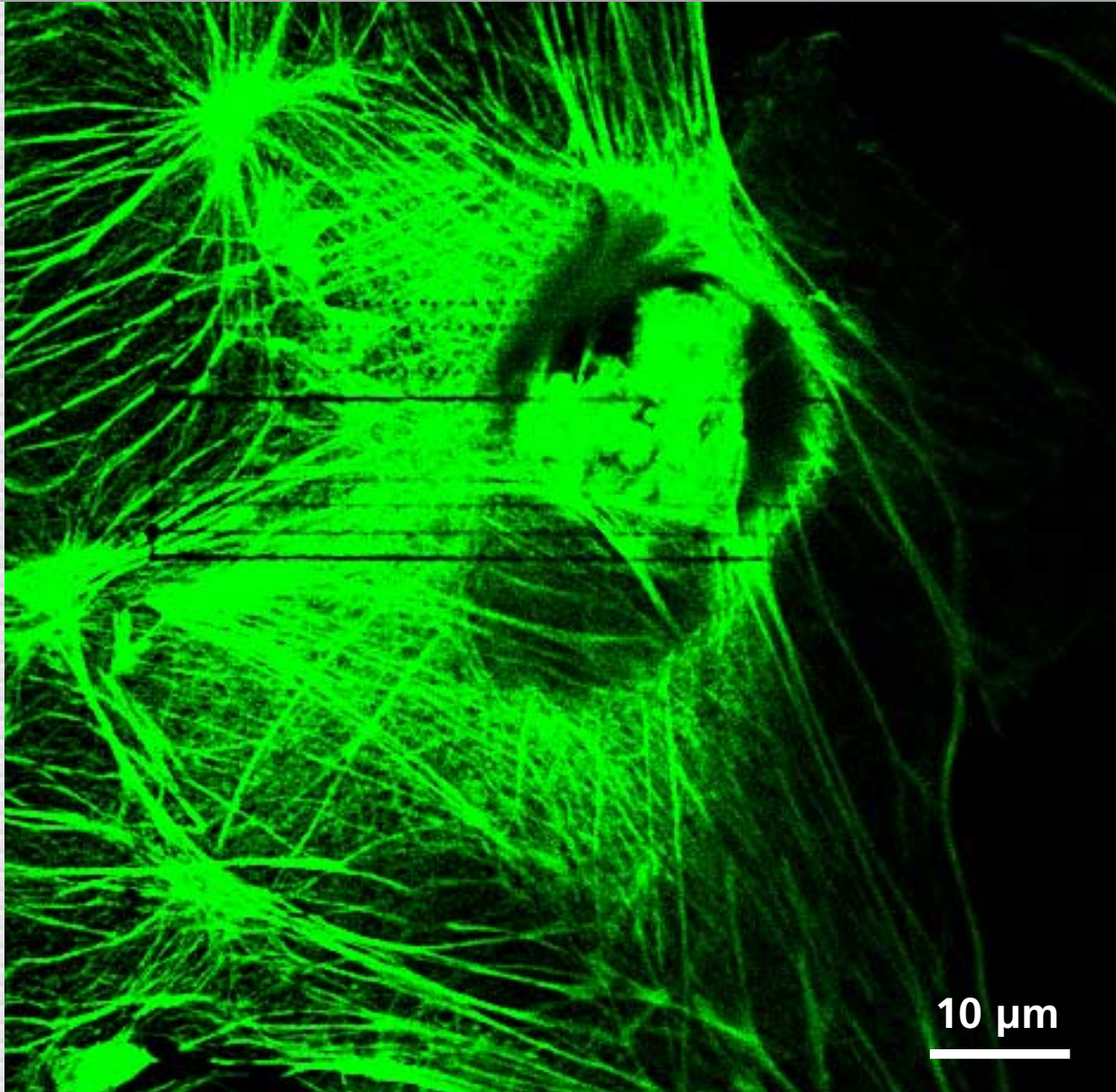

Low-energy processing

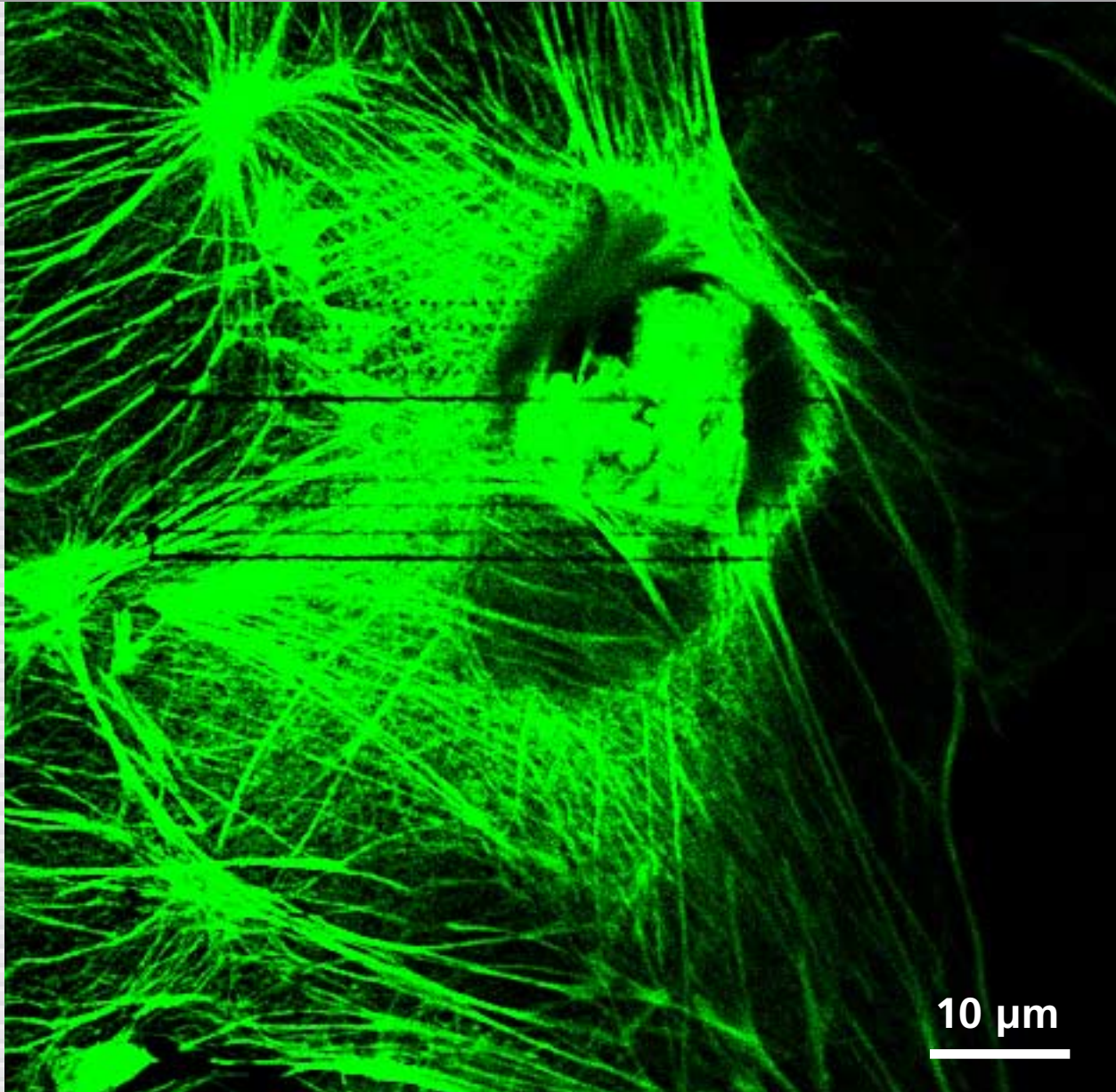

Low-energy processing

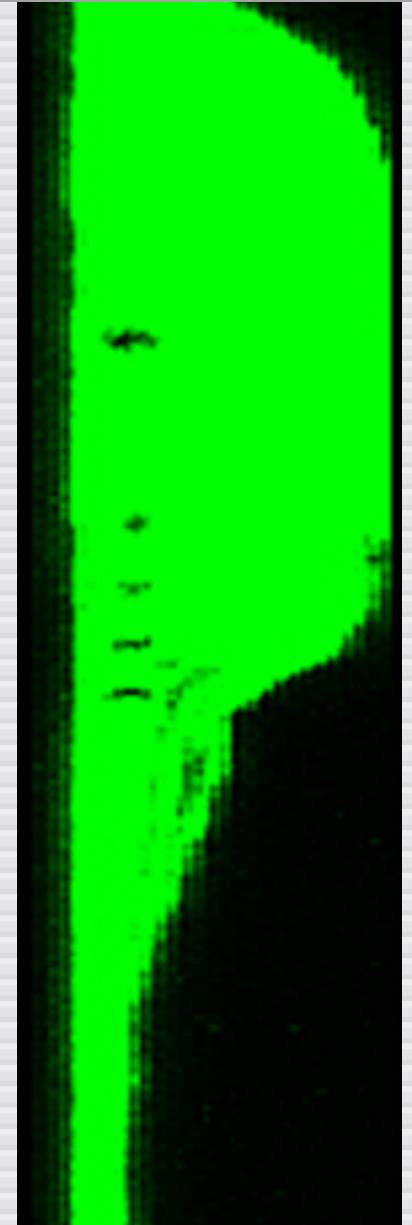
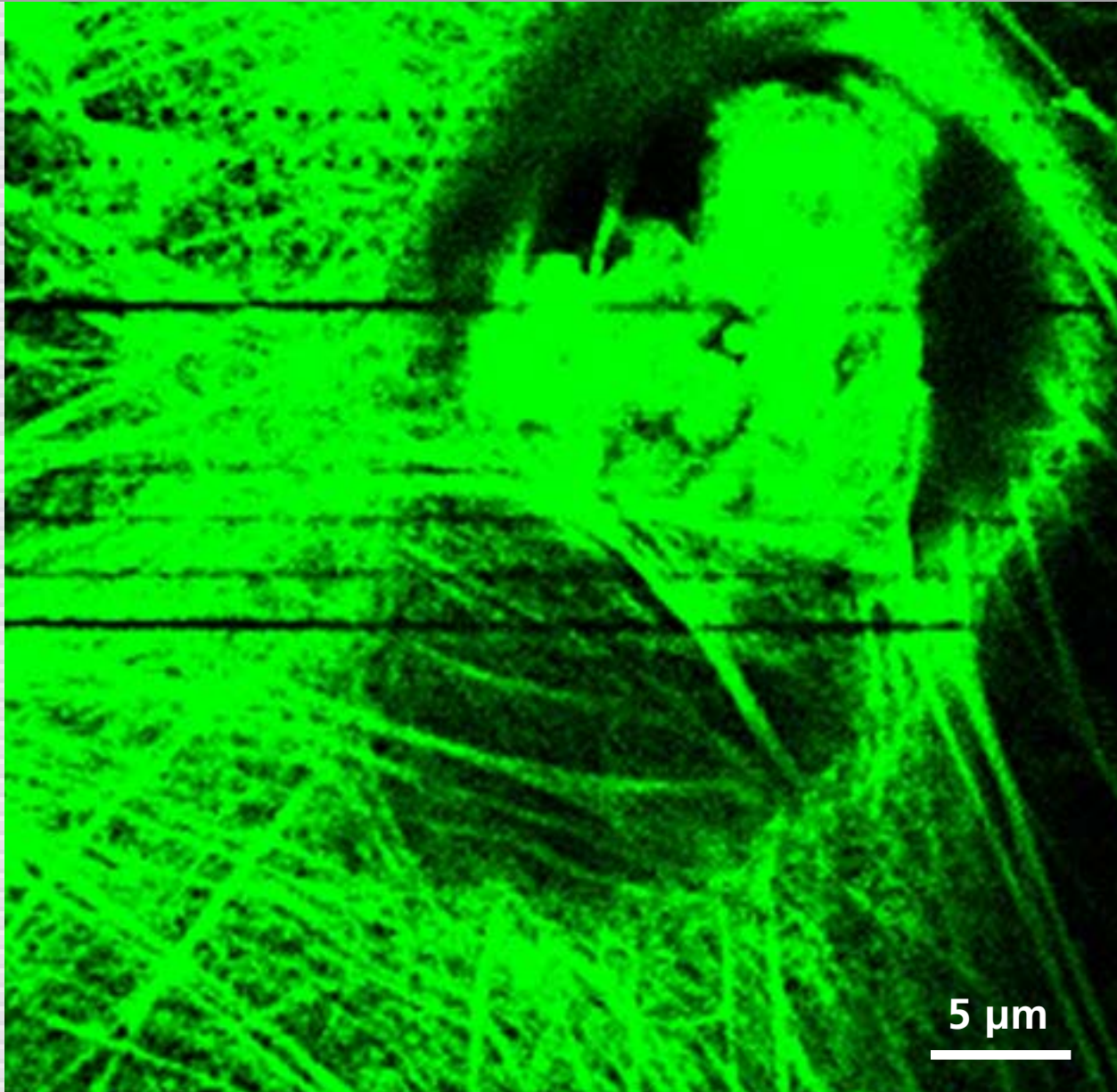

Low-energy processing

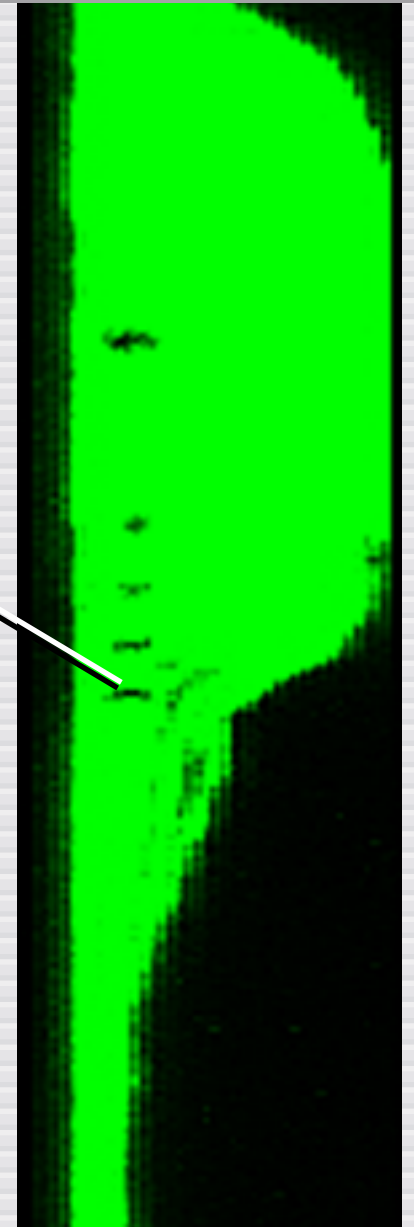
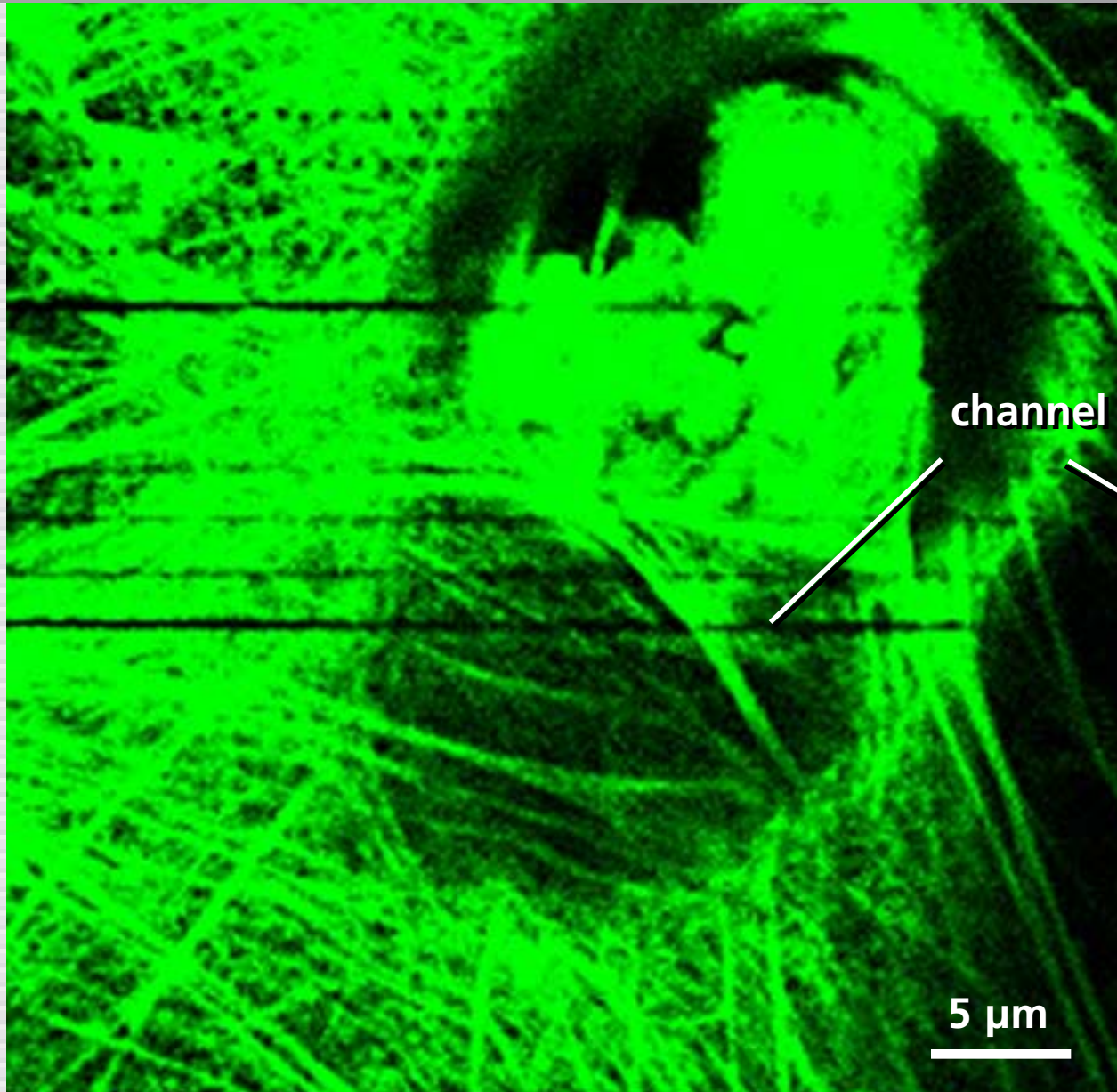

Low-energy processing

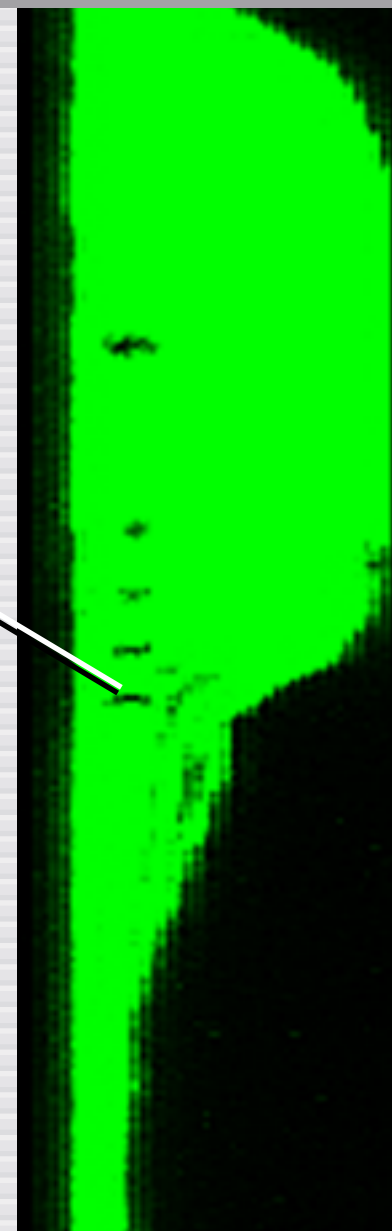
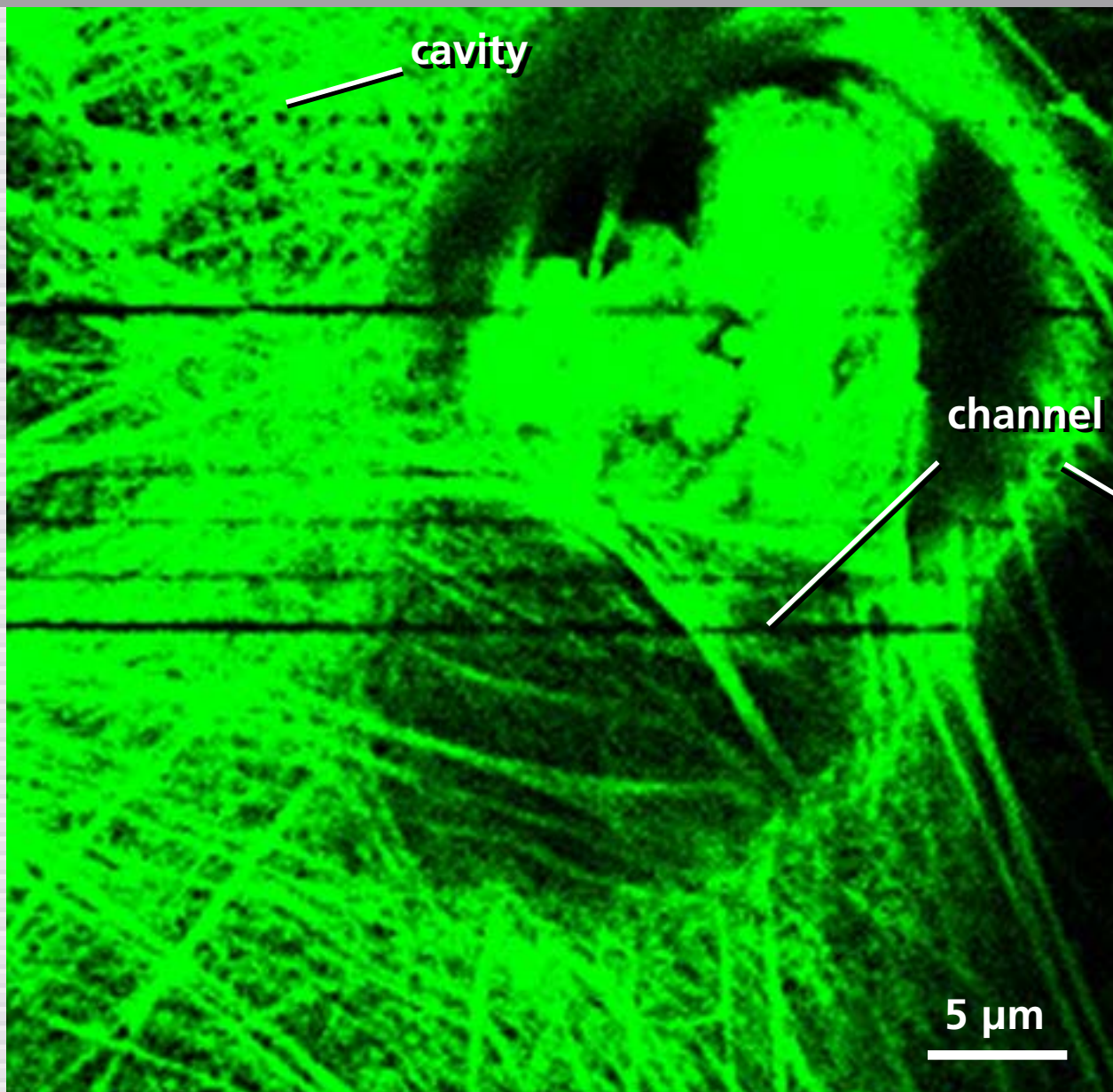

Low-energy processing

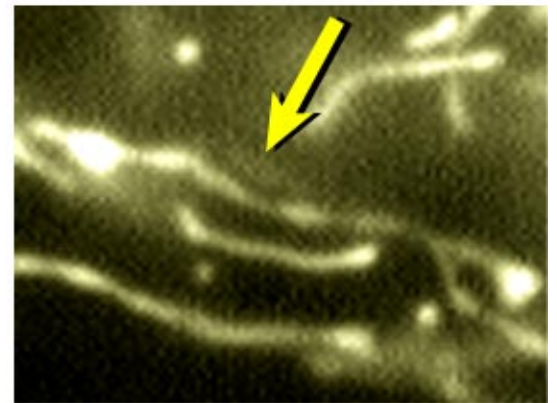
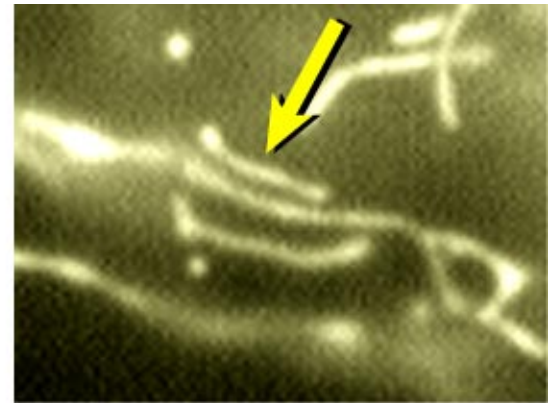
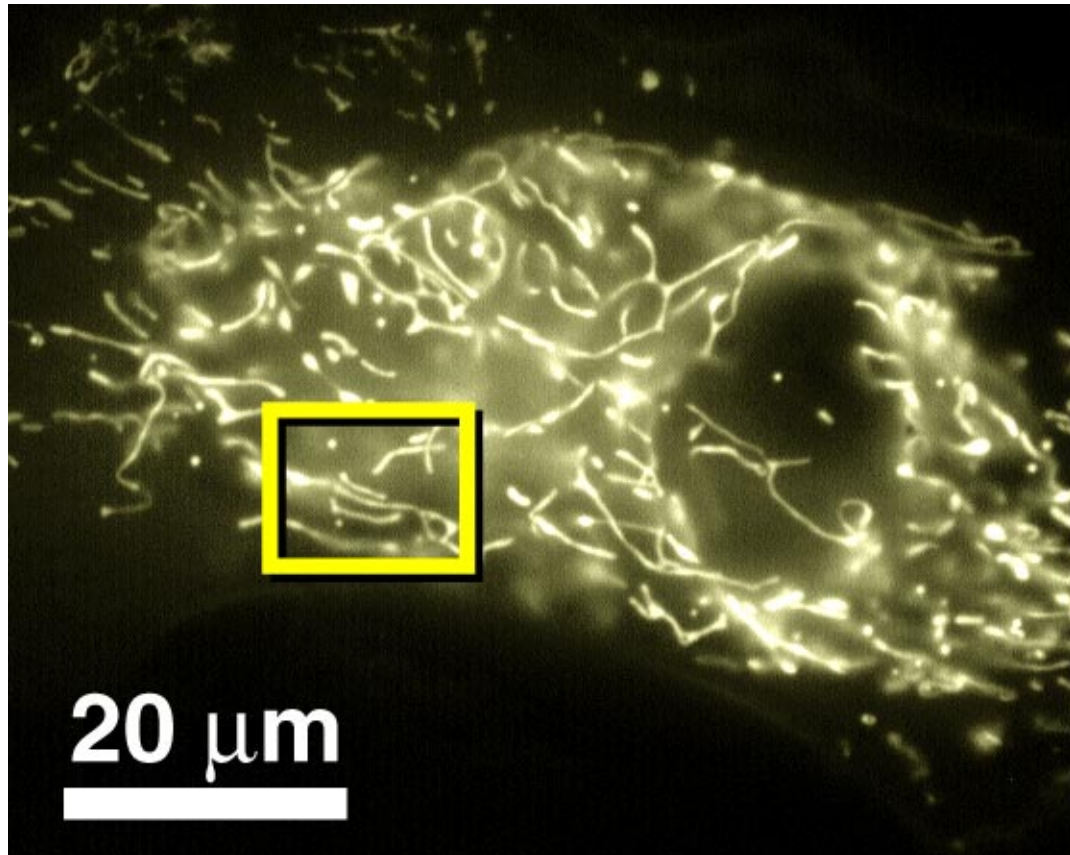

Low-energy processing

Ethydium bromide test

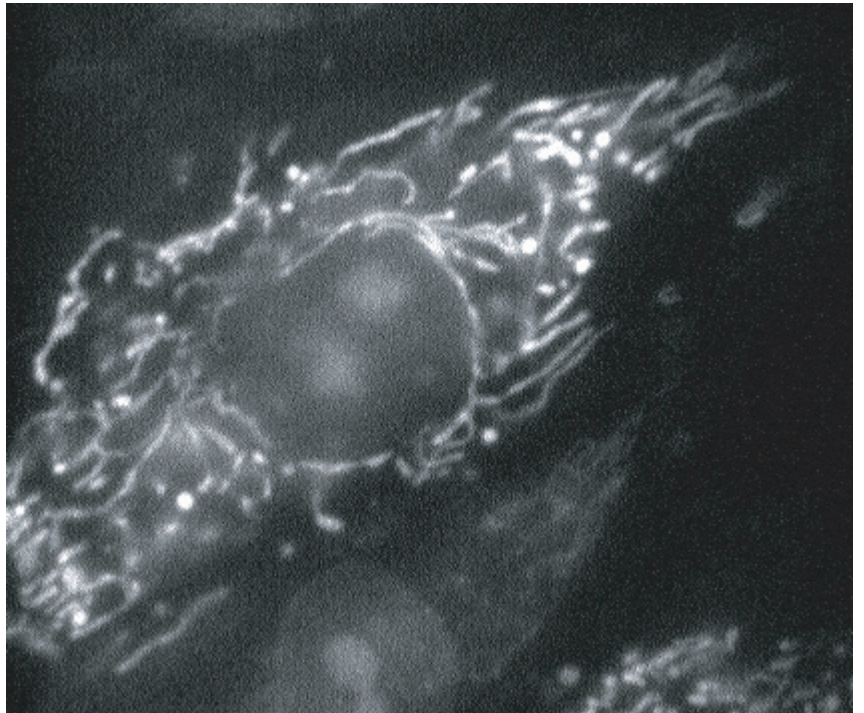
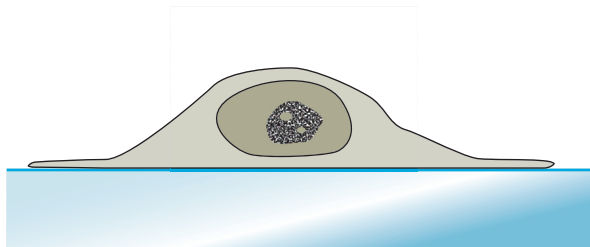

Low-energy processing

Ethydium bromide test

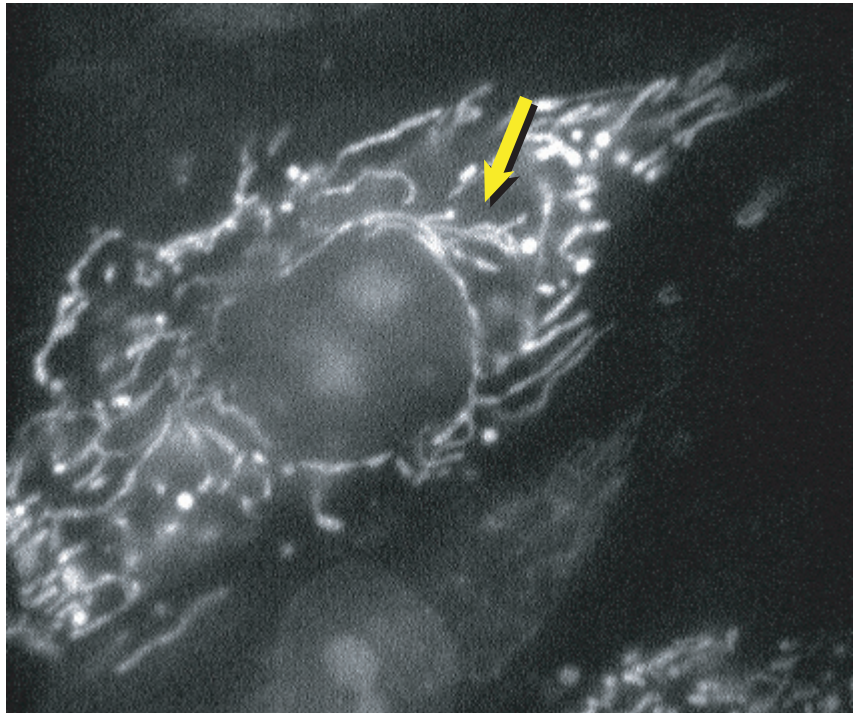
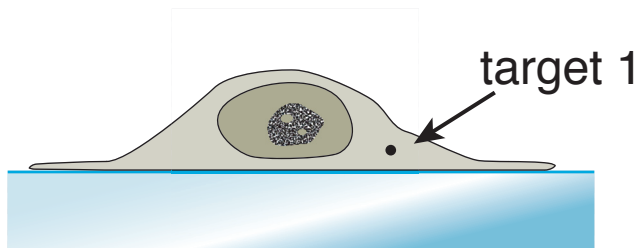

Low-energy processing

Ethydium bromide test

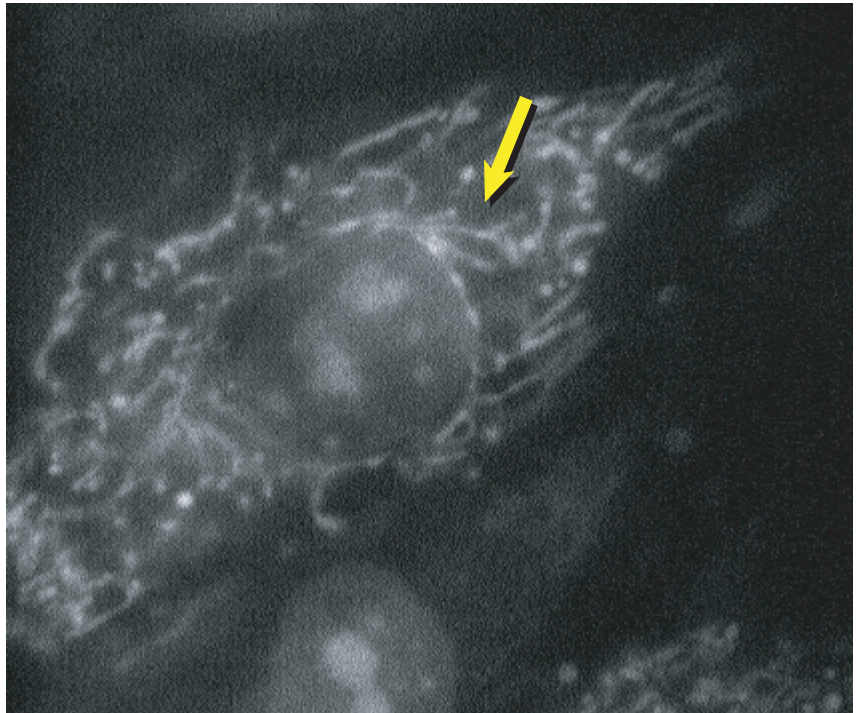
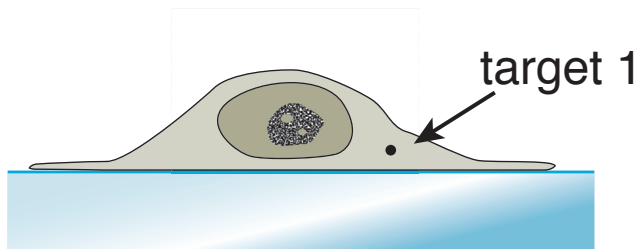

Low-energy processing

Ethydium bromide test

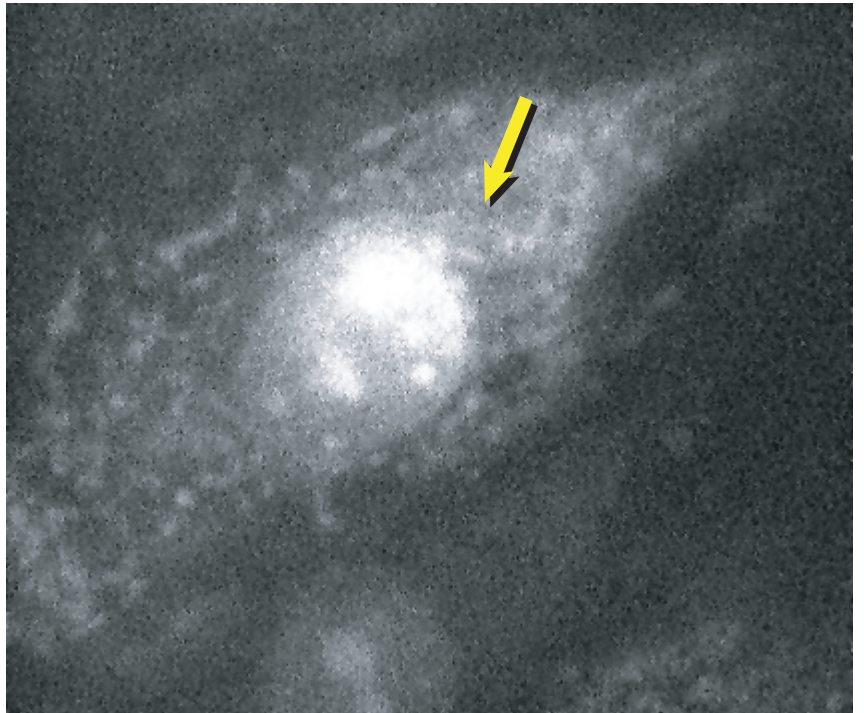
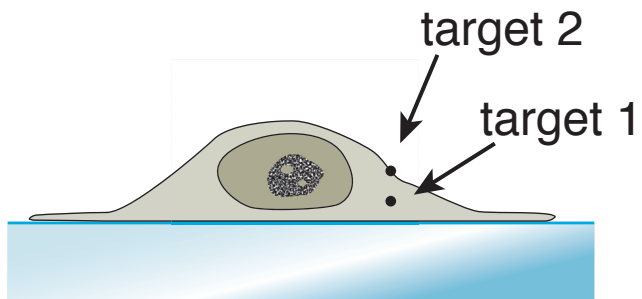

Nanoneurosurgery

Caenorhabditis Elegans



Juergen Berger & Ralph Sommer
Max-Planck Institute for Developmental Biology

Nanoneurosurgery

Caenorhabditis Elegans

- ▶ **simple model organism**

Nanoneurosurgery

Caenorhabditis Elegans

- ▶ **simple model organism**
- ▶ **similarities to higher organism**

Nanoneurosurgery

Caenorhabditis Elegans

- ▶ **simple model organism**
- ▶ **similarities to higher organism**
- ▶ **genome fully sequenced**

Nanoneurosurgery

Caenorhabditis Elegans

- ▶ **simple model organism**
- ▶ **similarities to higher organism**
- ▶ **genome fully sequenced**
- ▶ **easy to handle**

Nanoneurosurgery

▶ **80 μm x 1 mm**

Nanoneurosurgery

Caenorhabditis Elegans

- ▶ **80 μm x 1 mm**
- ▶ **about 1300 cells**

Nanoneurosurgery

Caenorhabditis Elegans

- ▶ **80 μm x 1 mm**
- ▶ **about 1300 cells**
- ▶ **302 neurons**

Nanoneurosurgery

Caenorhabditis Elegans

- ▶ **80 μm x 1 mm**
- ▶ **about 1300 cells**
- ▶ **302 neurons**
- ▶ **invariant wiring diagram**

Nanoneurosurgery

Caenorhabditis Elegans

- ▶ **80 μm x 1 mm**
- ▶ **about 1300 cells**
- ▶ **302 neurons**
- ▶ **invariant wiring diagram**
- ▶ **neuronal system completely encodes behavior**

Nanoneurosurgery

Caenorhabditis Elegans

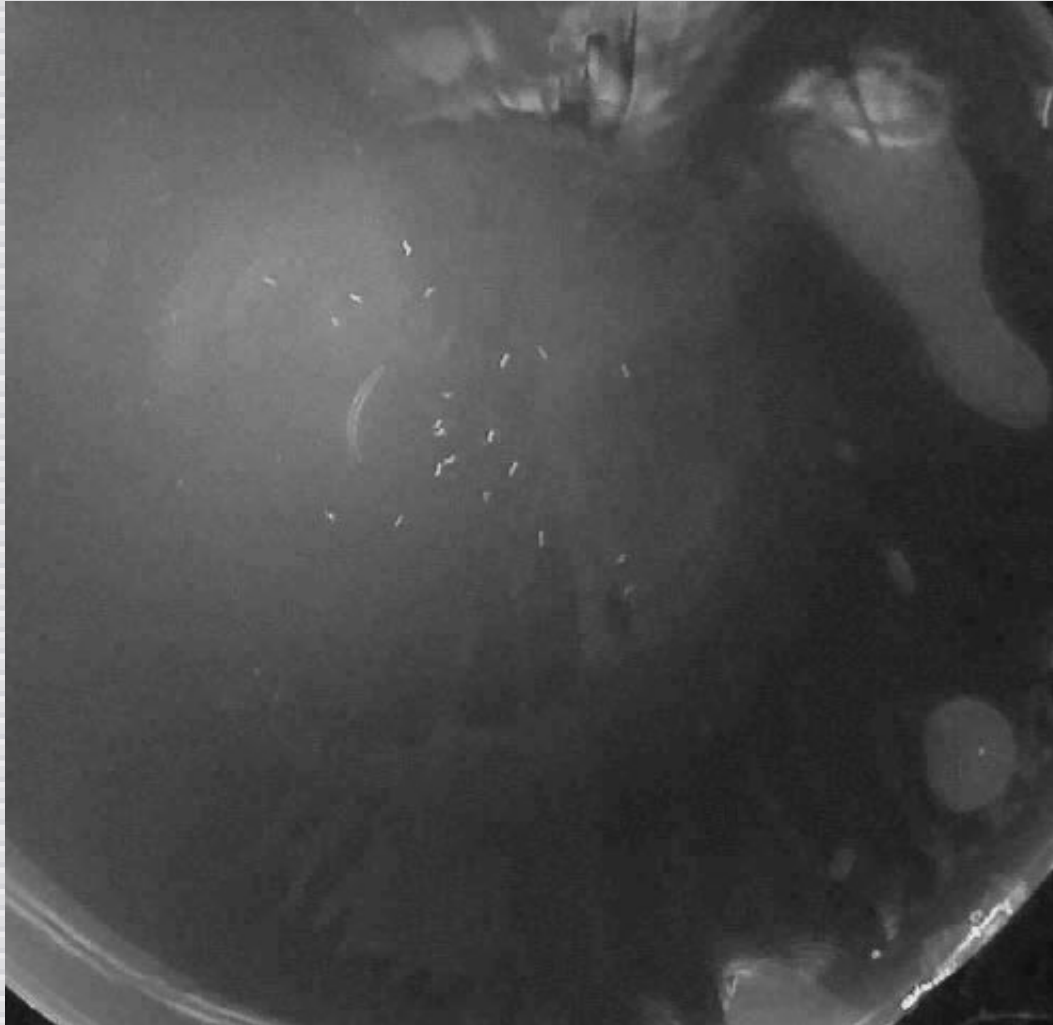

Nanoneurosurgery

Caenorhabditis Elegans



Bob Goldstein, UNC Chapel Hill

Nanoneurosurgery

Caenorhabditis Elegans

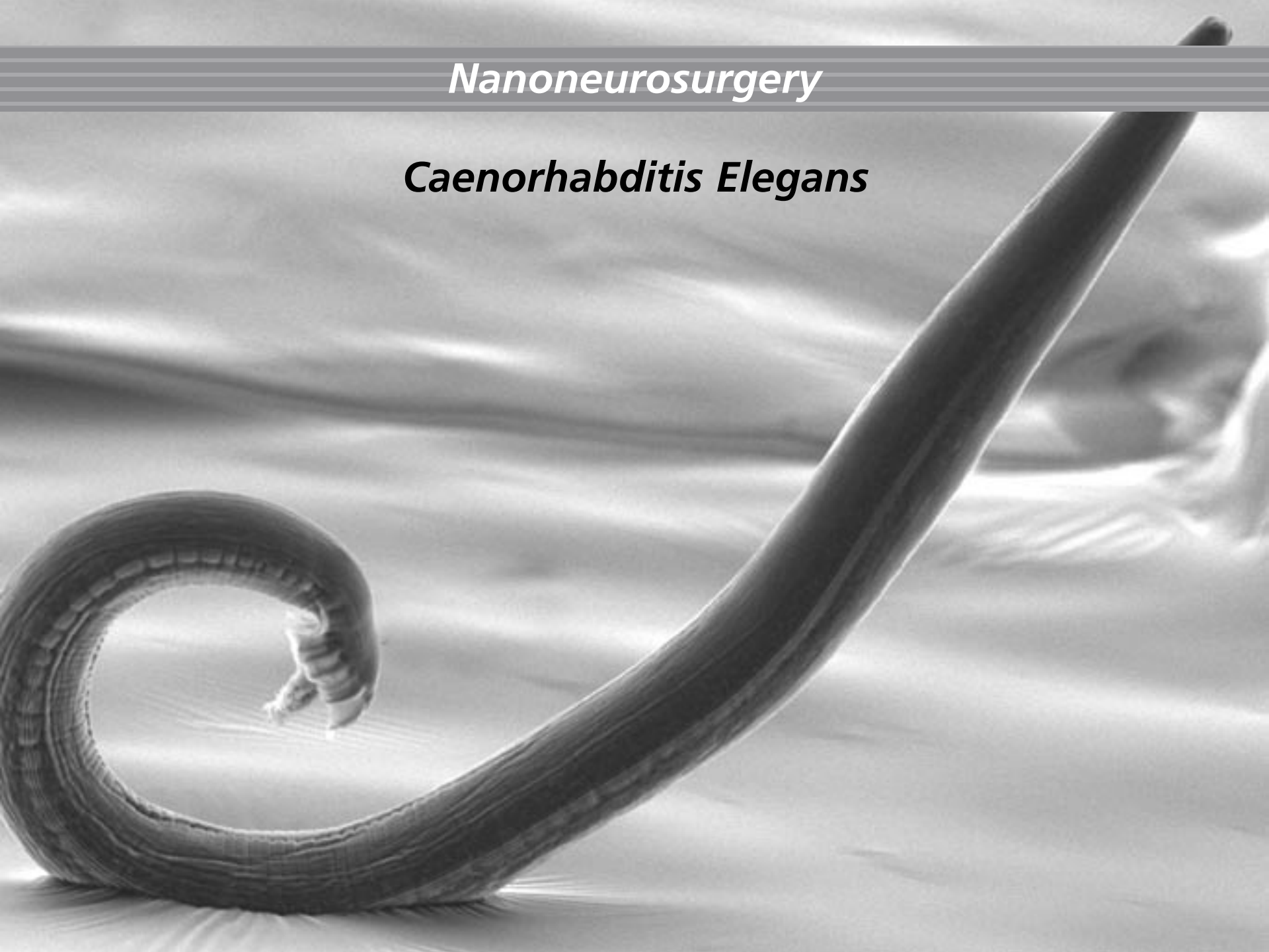

Nanoneurosurgery



Nanoneurosurgery

ASH neurons

- ▶ **responsible for osmotic avoidance**
- ▶ **ciliary projections extend through skin**
- ▶ **one on each side**

Nanoneurosurgery

make ASH neurons express GFP

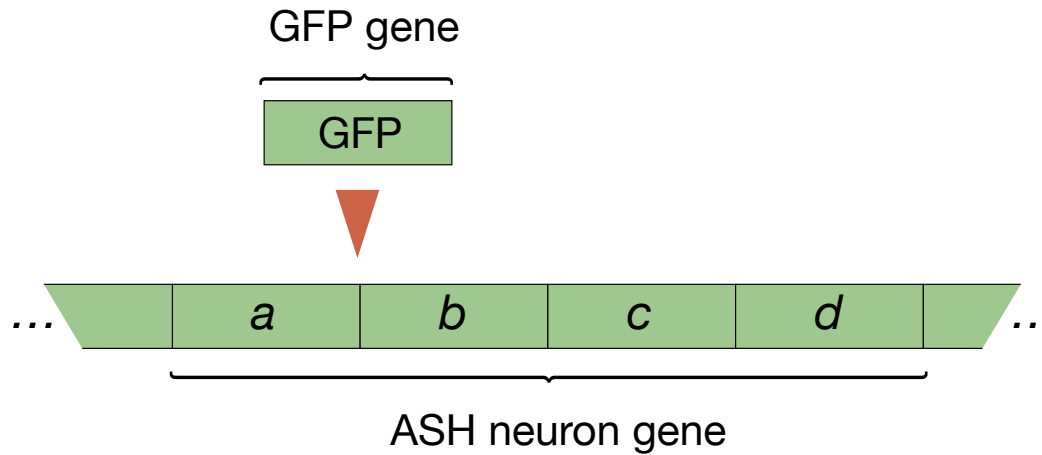

Nanoneurosurgery

GFP: absorbs UV, emits green



Nanoneurosurgery

cutting an axon

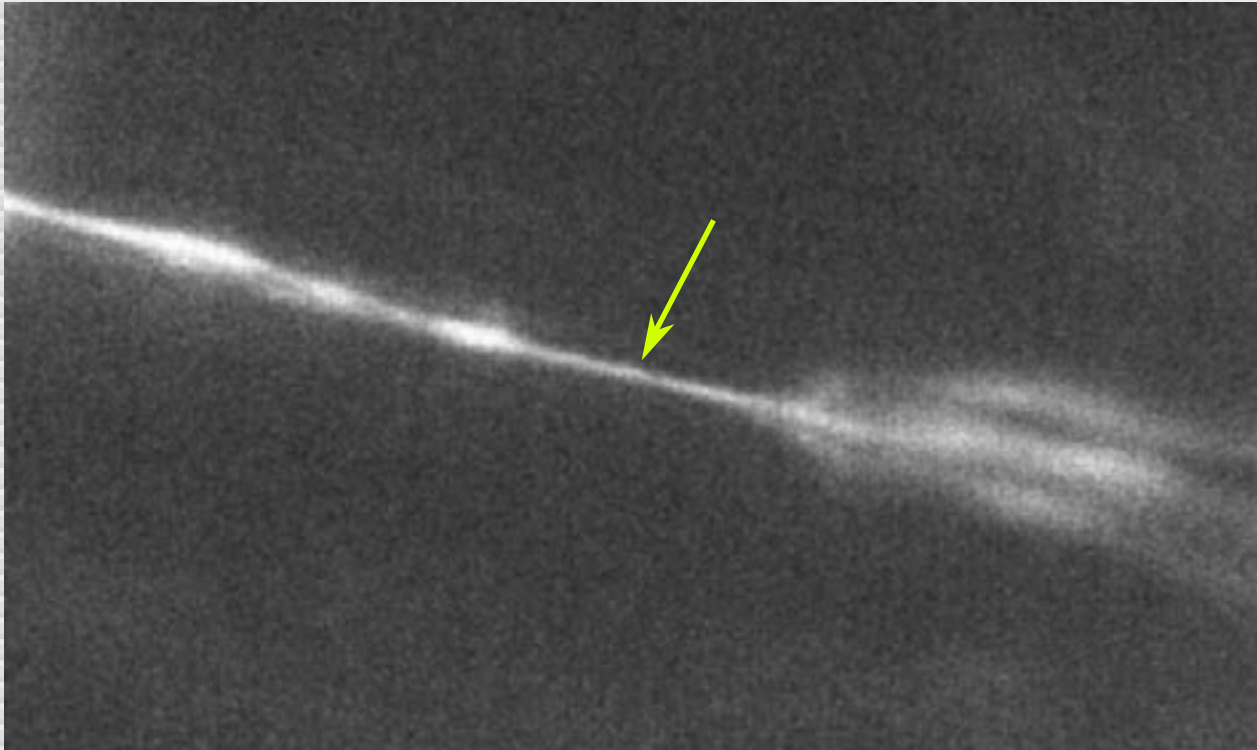

Nanoneurosurgery

cutting an axon

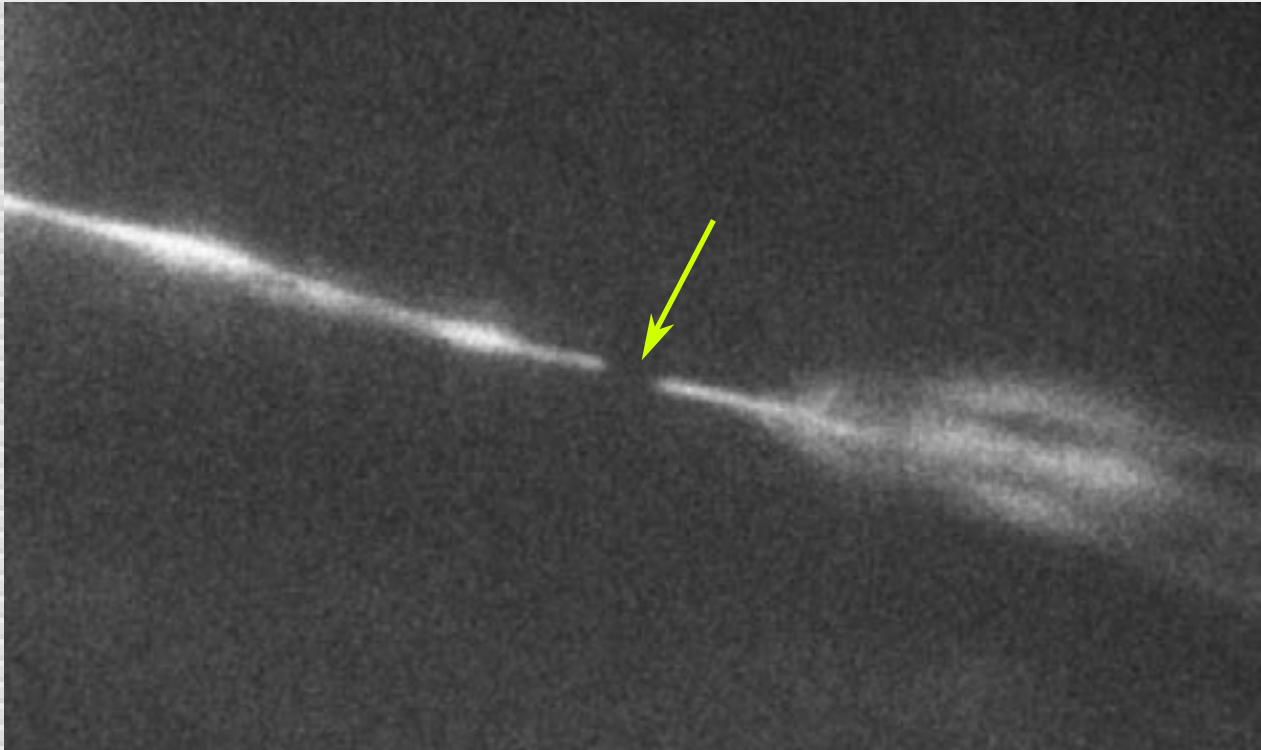

Nanoneurosurgery

pearling instability

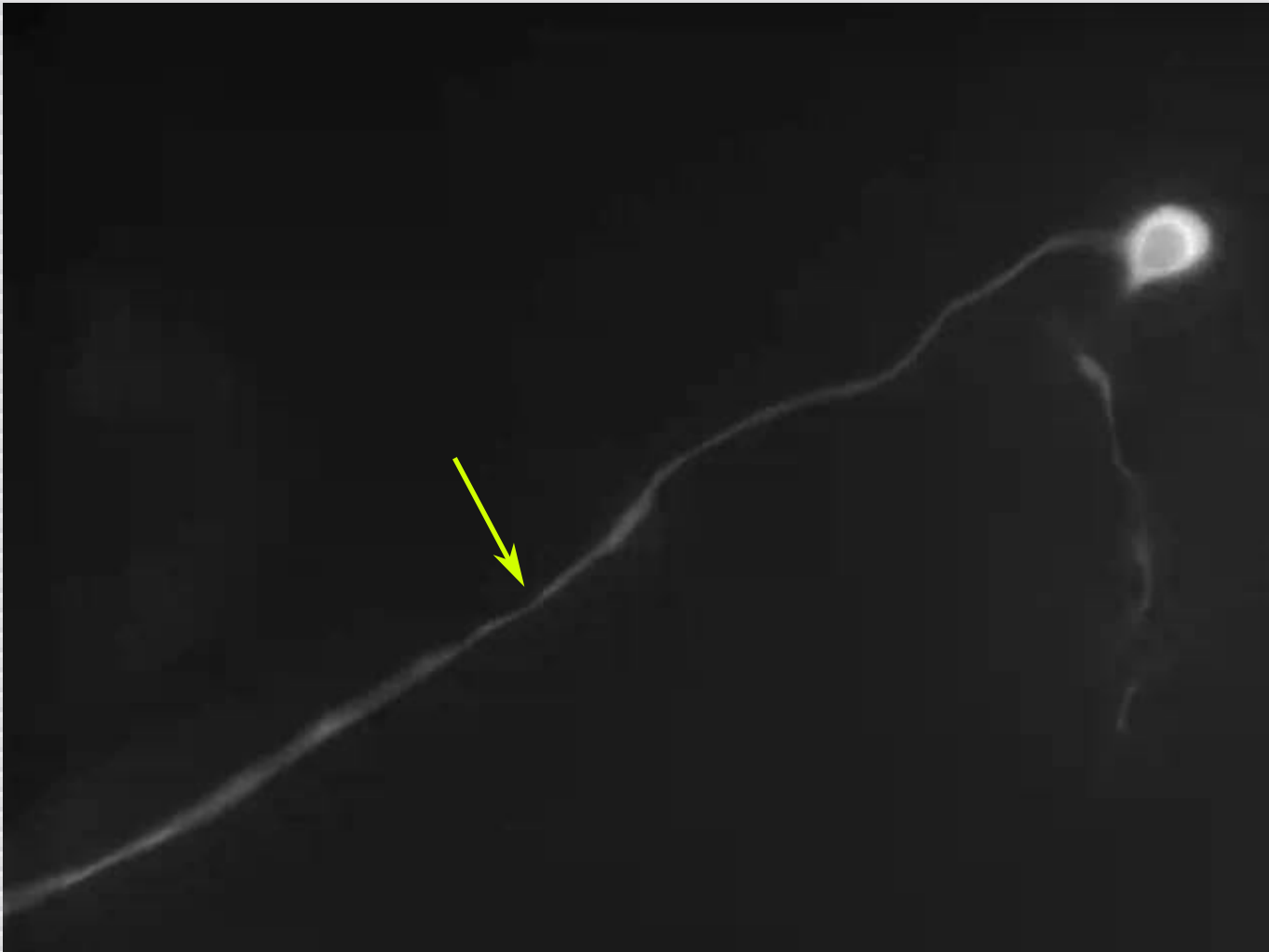

Nanoneurosurgery

pearling instability

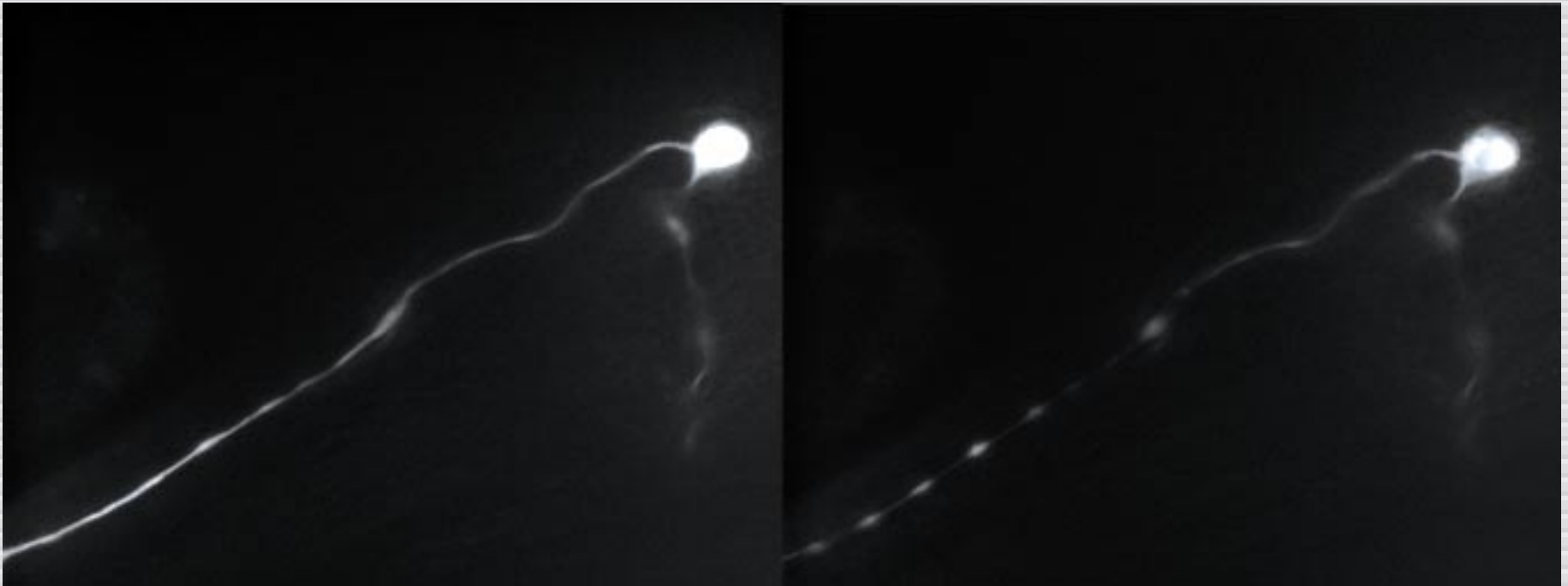

Summary

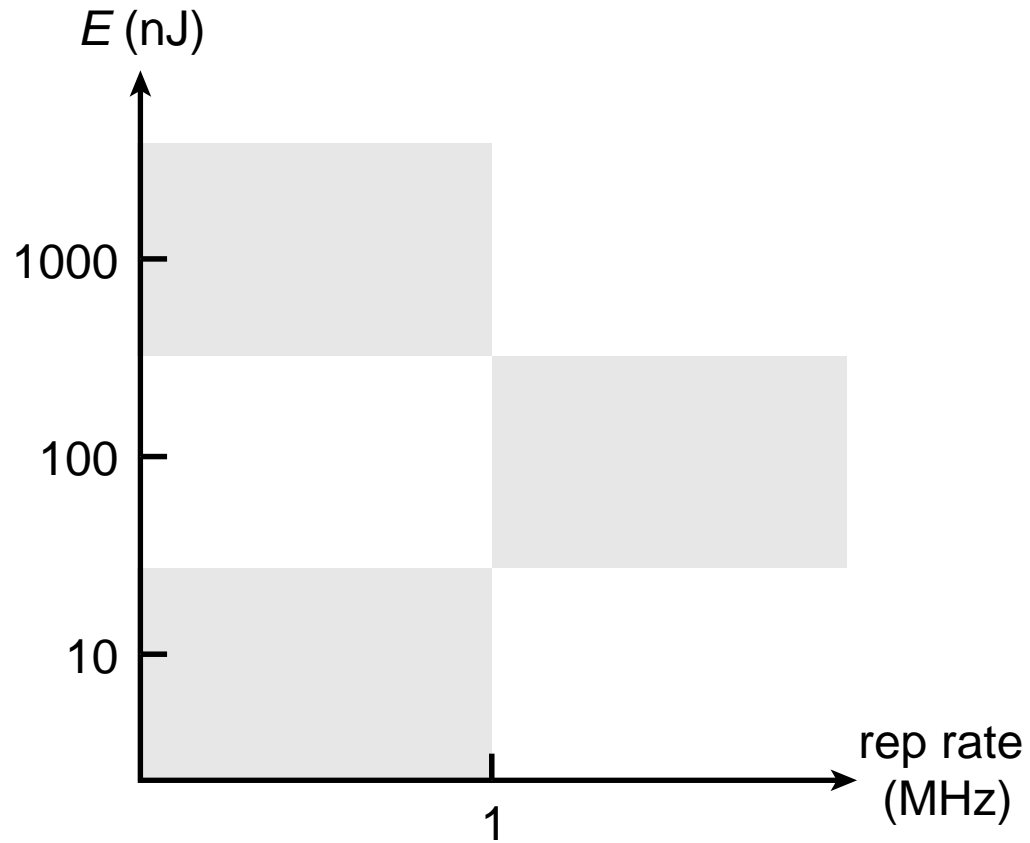

Summary

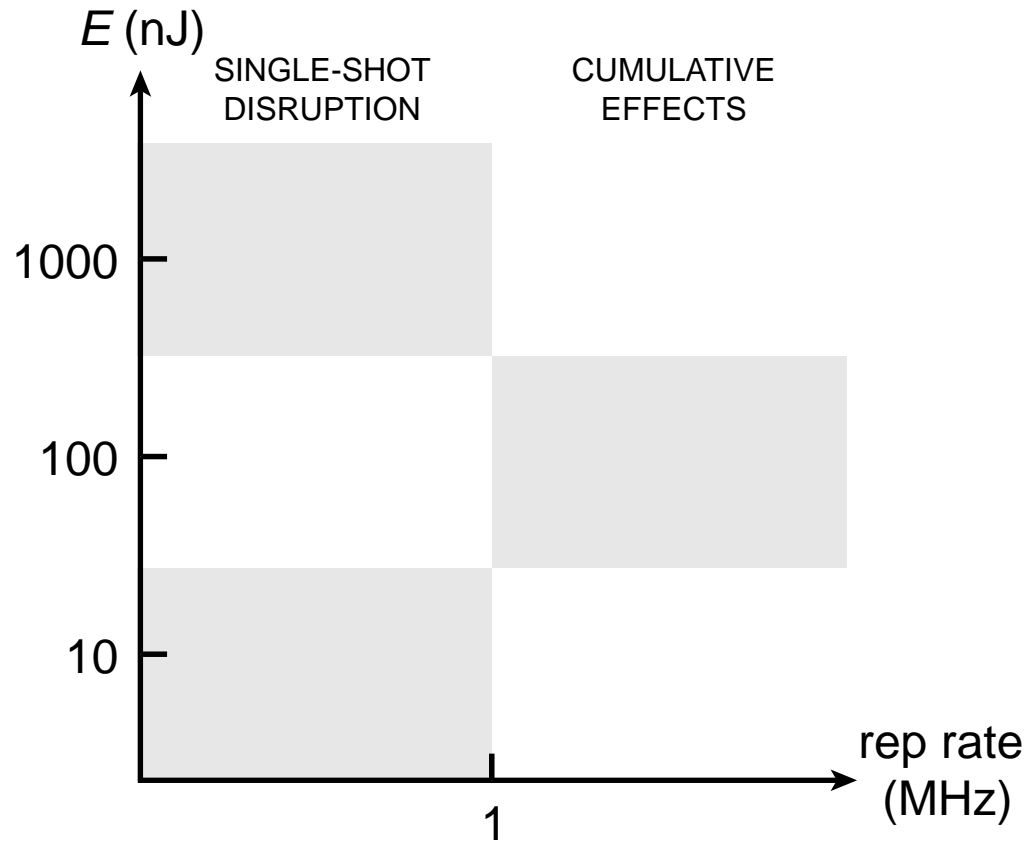

Summary

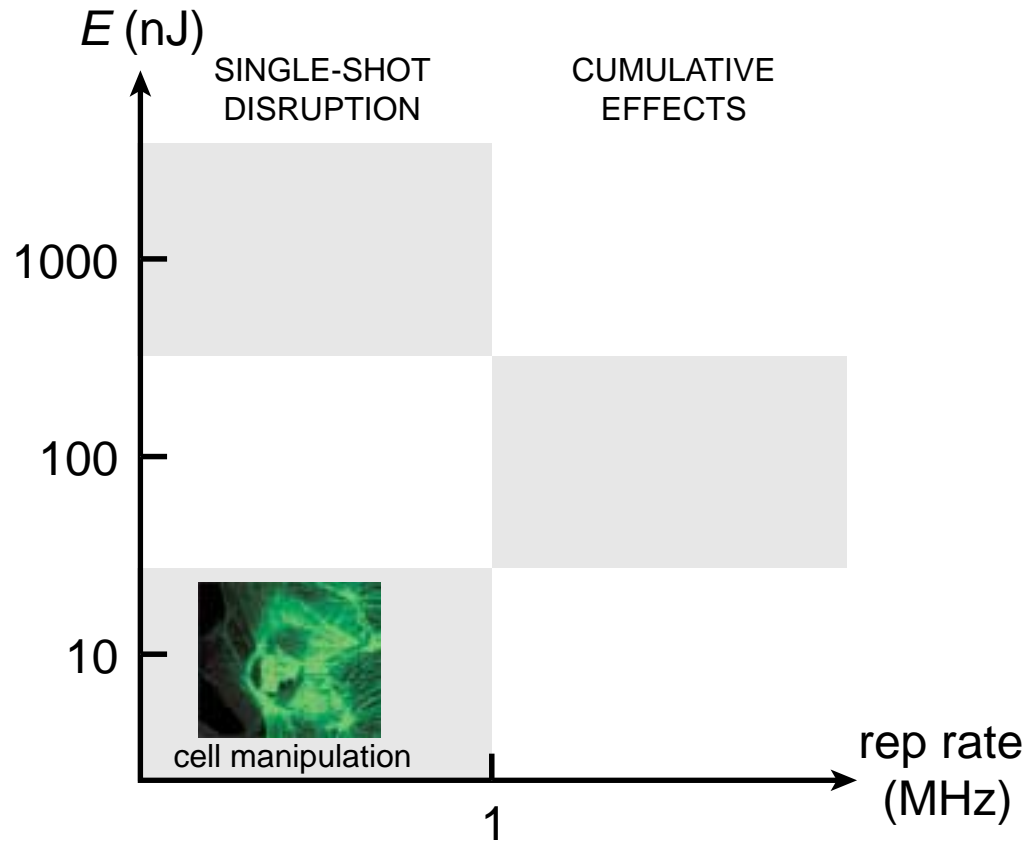

Summary

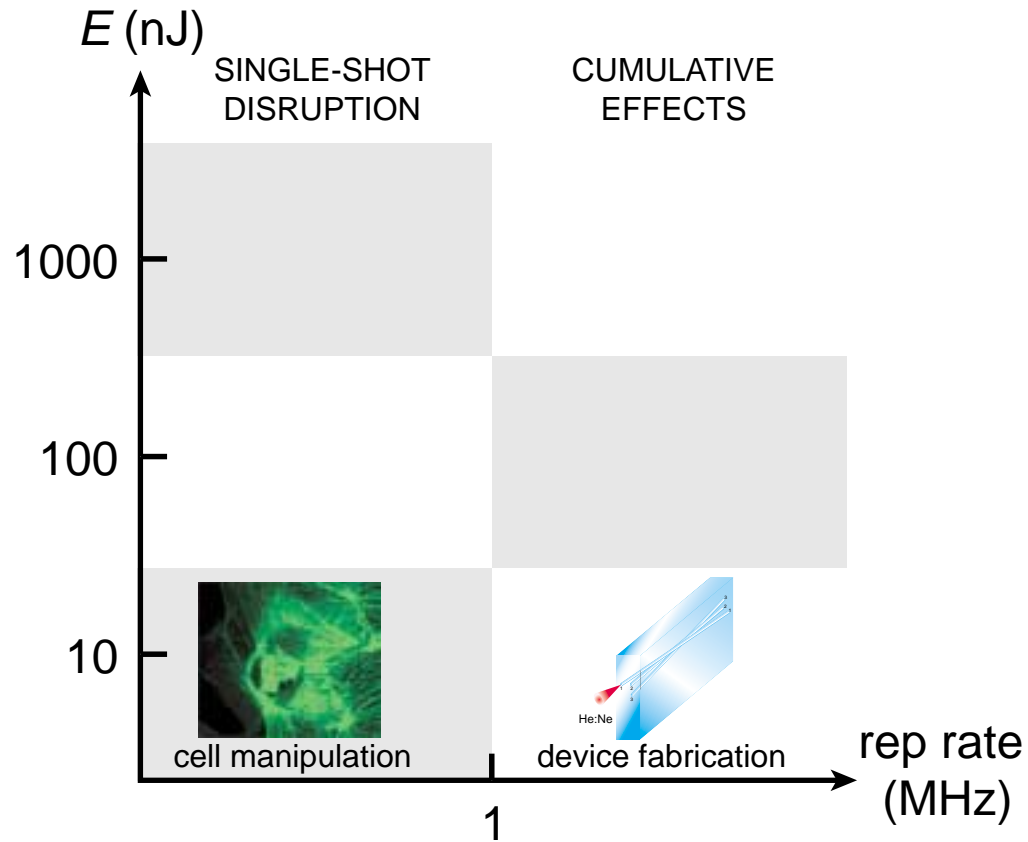

Summary

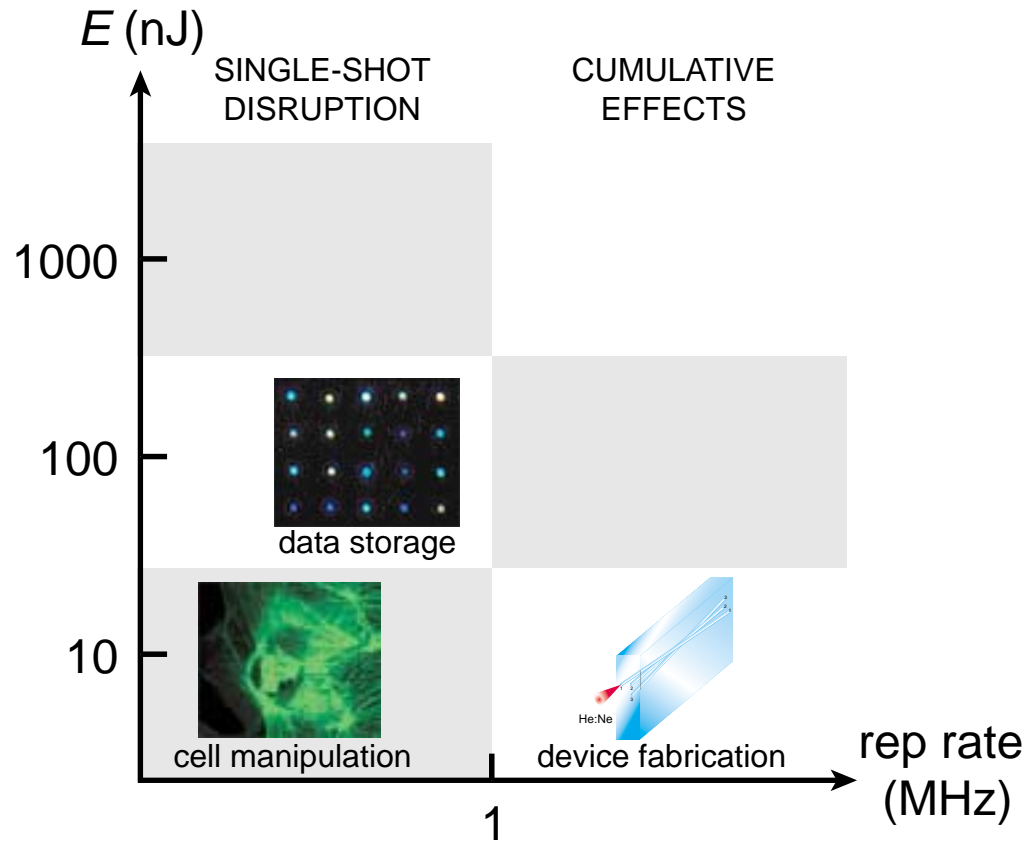

Summary

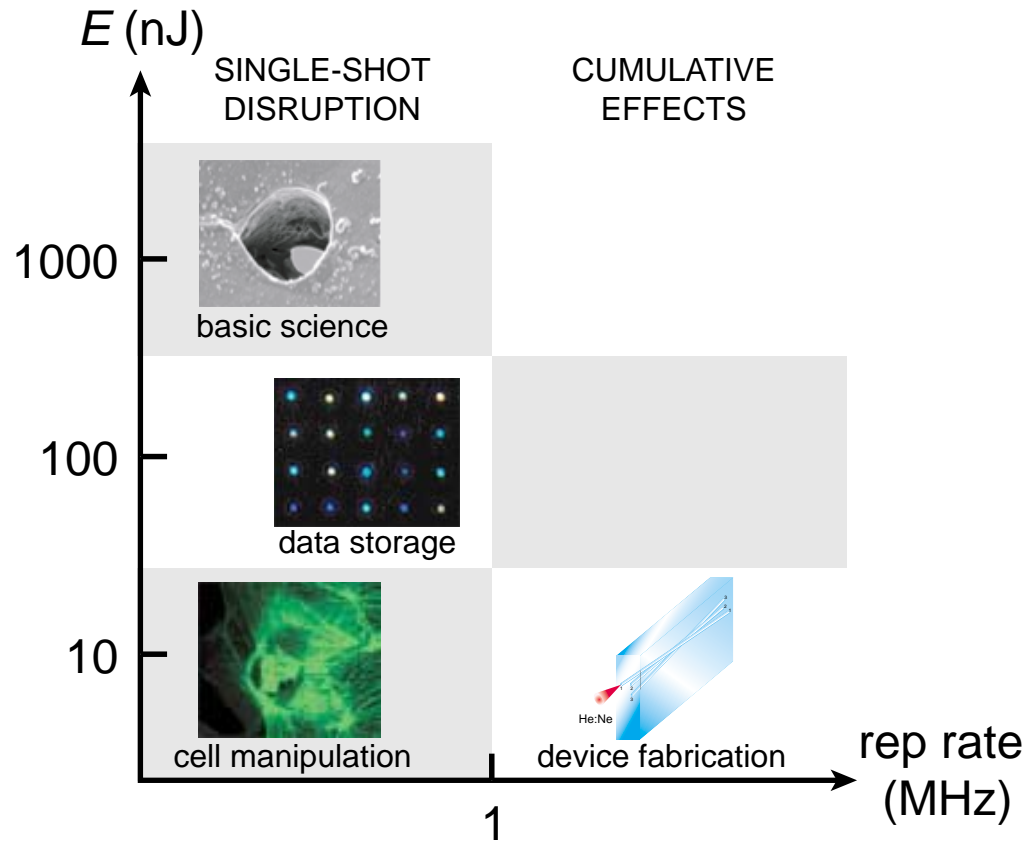

Conclusion

- ▶ **wiring optoelectronics circuits of the future**
- ▶ **manipulating the machinery of life**

GORDON MCKAY
LABORATORY OF
APPLIED SCIENCE

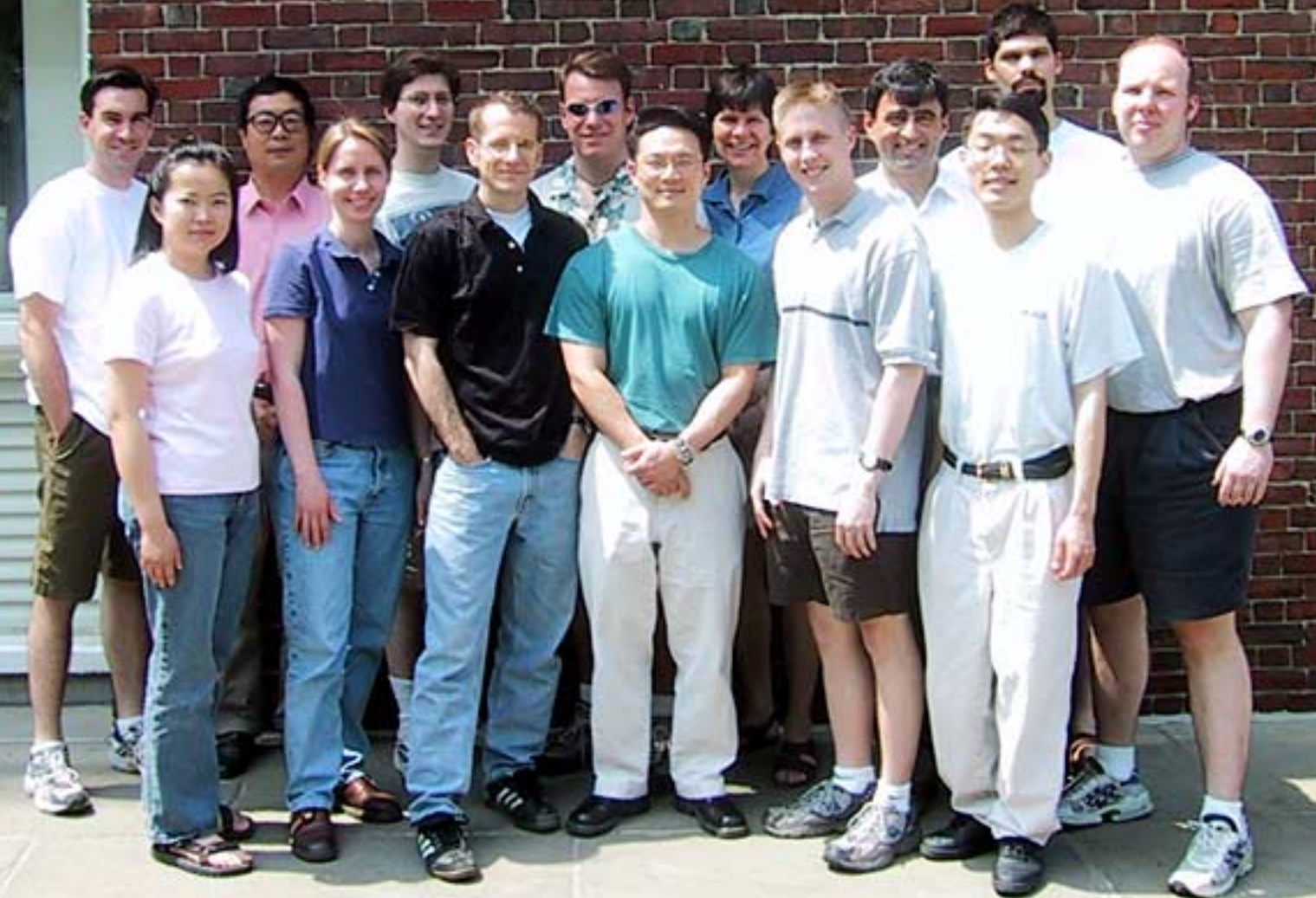

A group of approximately 15 people, including men and women of various ethnicities, are standing in a line in front of a red brick wall. The wall has some graffiti, including the name 'GORDON VICKY' and 'APPLIED SCIENCE'. The people are dressed in casual attire like t-shirts and jeans. The scene is outdoors during the day.

**Funding: National Science Foundation
Harvard Office of Technology and Trademark Licensing**

**Acknowledgments:
Prof. Nico Bloembergen (Harvard University)
Willie Leight (Yale University)
Yossi Chai (Sagitta, Inc.)**

**For a copy of this talk and
additional information, see:**

<http://mazur-www.harvard.edu>

Low-energy processing

bleaching or disruption?

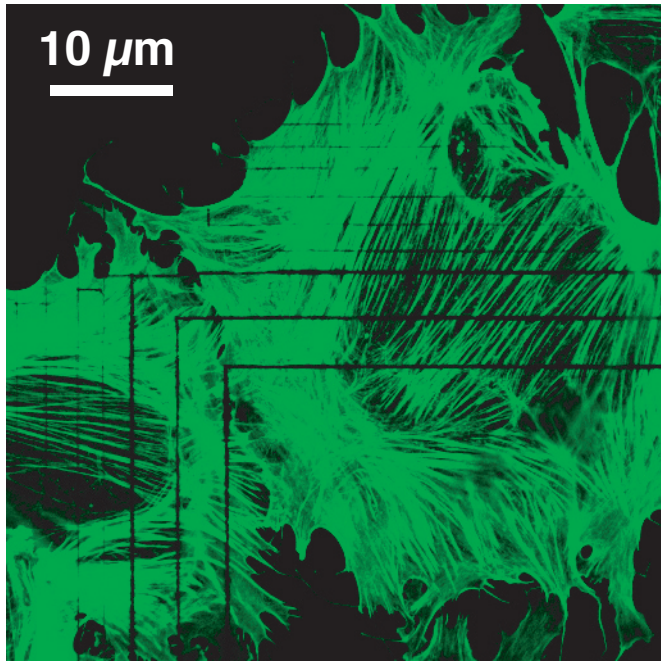

Low-energy processing

bleaching or disruption?

